



## Flexibles hidráulicos

*Flexible connectors*

Flexibles hydrauliques

Flessibili idrauliche

**TrAle®**



## Flexibles Industriales

*Industrial Flexible Hoses & Fittings*

Flexibles industriels

Tubi flessibili e raccordi industriali

**INDUS TrAle®**



## Tubo rígido

*Pipe connectors*

Connectique rigide

Tubo rigido

**TrAle®**



## Accesorios

*Accessories*

Accessoires

Accessori

**TrAle®**



# Flexibles hidráulicos

*Flexible connectors*

*Flexibles hydrauliques*

*Flessibili idrauliche*

# TrAle®



**Mangueras**

*Hoses*  
*Tuyaux*  
*Tubi flessibili*

1

**Racores para tubería flexible**

*Flexible hose fittings*  
*Embouts à sertir*  
*Raccordi per tubi flessibili*

2

**Metrología**

*Flow measuring*  
*Test du circuit hydraulique*  
*Test per circuiti idraulici*

3

# Mangueras

*Hoses*

*Tuyaux*

*Tubi flessibili*

## **Mangueras hidráulicas TrΔle GOLD**

*Hydraulic hoses TrΔle GOLD*

*Tuyaux hydrauliques TrΔle GOLD*

*Tubi idraulici TrΔle GOLD*

14

## **Mangueras hidráulicas TrΔle**

*Hydraulic hoses TrΔle*

*Tuyaux hydrauliques TrΔle*

*Tubi idraulici TrΔle*

18

## **Mangueras hidráulicas MW - GreenLine**

*Hydraulic hoses MW - GreenLine*

*Tuyaux hydrauliques MW - GreenLine*

*Tubi idraulici MW - GreenLine*

22

## **Mangueras termoplásticas TrΔle**

*Thermoplastic hoses TrΔle*

*Tuyaux thermoplastiques TrΔle*

*Tubi termoplastici TrΔle*

23

## **Mangueras PTFE TrΔle**

*PTFE hoses TrΔle*

*Tuyaux PTFE TrΔle*

*Tubi PTFE TrΔle*

26

1

# Mangueras hidráulicas TrΔle GOLD

Hydraulic hoses TrΔle GOLD

Tuyaux hydrauliques TrΔle GOLD

Tubi idraulici TrΔle GOLD

- Malla metálica TrΔle GOLD - RockCover / Steel Braid TrΔle GOLD - RockCover / Tresse métallique TrΔle GOLD - RockCover / Treccia metallica TrΔle GOLD - RockCover | 14



ML2230...RC

ML25C...RC

ML4290...RC

ML3511...RC

ML021...RC

ML4569...RC

- Malla metálica TrΔle GOLD - DiamondCover / Steel Braid TrΔle GOLD - DiamondCover / Tresse métallique TrΔle GOLD - DiamondCover / Treccia metallica TrΔle GOLD - DiamondCover | 15



ML3511...DC

ML4569..DC

- Malla metálica TrΔle GOLD - HighPressure / Steel Braid TrΔle GOLD - HighPressure / Tresse métallique TrΔle GOLD - HighPressure / Treccia metallica TrΔle GOLD - HighPressure | 16



MS1SNK

MS2SNK

- TrΔle GOLD - FlexyLine / TrΔle GOLD - FlexyLine / TrΔle GOLD - FlexyLine / TrΔle GOLD - FlexyLine | 16



FLEX6000

# Mangueras hidráulicas TrΔle

Hydraulic hoses TrΔle  
Tuyaux hydrauliques TrΔle  
Tubi idraulici TrΔle

## ■ Malla textil TrΔle / TrΔle Textile braid / Tresse textile TrΔle / Treccia tessile TrΔle

18



MSB21

ML7010

MB22

M2503

MB23

## ■ Malla metálica TrΔle / TrΔle steel braid / Tresse métallique TrΔle / Treccia metallica TrΔle

19



MS2230

MS3509

MS3511

M15C

M25C

ML3601

MS4290

M4612



MS4569

M4713

MS4815

## ■ Agua caliente TrΔle / TrΔle Hydrowashing hose for hot water / Tuyau lavage haute pression-TrΔle / Tubi per idropultrici ad acqua calda TrΔle

21



MSC011...N

MSC021...N

MSC011...A

MSC021...A

MSC022...A

MSC020...G

MSC1021...A

# Mangueras hidráulicas MW - GreenLine

*Hydraulic hoses MW - GreenLine*

*Tuyaux hydrauliques MW - GreenLine*

*Tubi idraulici MW - GreenLine*

- Malla metálica MW - GreenLine / Steel braid MW - GreenLine / Tresse métallique MW - GreenLine / Treccia metallica MW - GreenLine | 22



MW2230



MW25C



MW4290



MW3511



MWC021...A



MW4569

# Mangueras termoplásticas TrΔle

*Thermoplastic hoses TrΔle*

*Tuyaux thermoplastiques TrΔle*

*Tubi termoplastici TrΔle*

## ■ Malla textil TrΔle / TrΔle textile braid / Tresse textile TrΔle / Treccia tessile TrΔle

23



## ■ Malla metálica TrΔle / TrΔle steel braid / Tresse métallique TrΔle / Treccia metallica TrΔle

24



## ■ Limpieza de alcantarillas TrΔle / Sewer jetting hose TrΔle / Tuyau hydrocurage TrΔle / Tubi per la pulizia di fognature

25



# Mangueras PTFE TrΔle

PTFE hoses TrΔle  
Tuyaux PTFE TrΔle  
Tubi PTFE TrΔle

- PTFE liso /Smooth PTFE /PTFE lisse /PTFE liscio

26



M2950

M2900

M29012

- PTFE corrugado /Convolutated PTFE /PTFE convoluté /PTFE corrugato

26



M2920

M2980

M2930

- PTFE Liso PTFLEX /PTFLEX Smooth PTFE /PTFE Lisse PTFLEX /PTFE Liscio PTFLEX

27



M2940

# Mangueras hidráulicas TrΔle GOLD

Hydraulic hoses TrΔle GOLD

Tuyaux hydrauliques TrΔle GOLD

Tubi idraulici TrΔle GOLD

## Manguera TrΔle Gold EN 853 1SN - RockCover

EN 853 1SN hose TrΔle Gold - RockCover

Tuyau TrΔle Gold EN 853 1SN - RockCover

Tubi EN 853 1SN TrΔle Gold - RockCover



DN	Part nº Referencia	€
1/4"	ML223004RC	6,97
5/16"	ML223005RC	7,36
3/8"	ML223006RC	8,66
1/2"	ML223008RC	10,55
5/8"	ML223010RC	13,68
3/4"	ML223012RC	15,37
1"	ML223016RC	21,76
1"1/4	ML223020RC	30,94
1"1/2	ML223024RC	41,56
2"	ML223032RC	53,67

## Manguera TrΔle Gold EN 853 2SN - RockCover

EN 853 2SN hose TrΔle Gold - RockCover

Tuyau TrΔle Gold EN 853 2SN - RockCover

Tubi EN 853 2SN TrΔle Gold - RockCover



DN	Part nº Referencia	€
1/4"	ML351104RC	9,45
5/16"	ML351105RC	10,16
3/8"	ML351106RC	11,01
1/2"	ML351108RC	12,70
5/8"	ML351110RC	17,39
3/4"	ML351112RC	20,13
1"	ML351116RC	29,57
1"1/4	ML351120RC	47,75
1"1/2	ML351124RC	57,06
2"	ML351132RC	72,56

## Manguera TrΔle Gold EN 857 2SC - RockCover

EN 857 2SC hose TrΔle Gold - RockCover

Tuyau TrΔle Gold EN 857 2SC - RockCover

Tubi EN 857 2SC TrΔle Gold - RockCover



DN	Part nº Referencia	€
1/4"	ML25C04RC	8,88
3/8"	ML25C06RC	10,38
1/2"	ML25C08RC	12,44
5/8"	ML25C10RC	17,00
3/4"	ML25C12RC	18,88
1"	ML25C16RC	27,82

## Superservicio agua caliente 2 mallas negra 400bar TrΔle Gold - RockCover

Hot water black superservice 2 braids 400bar TrΔle Gold - RockCover

Superservice eau chaude 2 tresses noir 400bar TrΔle Gold - RockCover

Superservice acqua calda 2 trecce, nero 400bar TrΔle Gold - RockCover



DN	Part nº Referencia	€
5/16"	MLC0215NRC	10,29
3/8"	MLC0216NRC	12,10

## Manguera TrΔle Gold EN 856 4SH - RockCover

EN 856 4SH hose TrΔle Gold - RockCover

Tuyau TrΔle Gold EN 856 4SH - RockCover

Tubi EN 856 4SH TrΔle Gold - RockCover



DN	Part nº Referencia	€
3/4"	ML456912RC	41,56
1"	ML456916RC	50,35
1"1/4	ML456920RC	74,52
1"1/2	ML456924RC	93,73
2"	ML456932RC	134,31

## Manguera TrΔle Gold EN 856 4SP - RockCover

EN 856 4SP hose TrΔle Gold - RockCover

Tuyau TrΔle Gold EN 856 4SP - RockCover

Tubi EN 856 4SP TrΔle Gold - RockCover



DN	Part nº Referencia	€
3/8"	ML429006RC	27,03
1/2"	ML429008RC	27,36
5/8"	ML429010RC	32,83
3/4"	ML429012RC	38,24
1"	ML429016RC	48,98

**TrΔle GOLD RockCover**

**RESISTENCIA EXTREMA**

**EXTREME RESISTANCE**

# Mangueras hidráulicas TrΔle GOLD

Hydraulic hoses TrΔle GOLD  
Tuyaux hydrauliques TrΔle GOLD  
Tubi idraulici TrΔle GOLD

Hoses

Flexible hose fittings

Flow measuring

Equipment for flexible hoses

## Manguera TrΔle Gold EN 853 2SN - DiamondCover

EN 853 2SN hose TrΔle Gold - DiamondCover

Tuyau TrΔle Gold EN 853 2SN - DiamondCover

Tubi EN 853 2SN TrΔle Gold - DiamondCover



DN	Part nº Referencia	€
1/4"	ML351104DC	9,91
3/8"	ML351106DC	11,55
1/2"	ML351108DC	13,34

## Manguera TrΔle Gold EN 856 4SH - DiamondCover

EN 856 4SH hose TrΔle Gold - DiamondCover

Tuyau TrΔle Gold EN 856 4SH - DiamondCover

Tubi EN 856 4SH TrΔle Gold - DiamondCover



DN	Part nº Referencia	€
3/4"	ML456912DC	43,63
1"	ML456916DC	52,89

### RESISTENCIA A LA ABRASIÓN (ISO 6945)

#### ABRASION RESISTANCE

25N / 2000 cycles

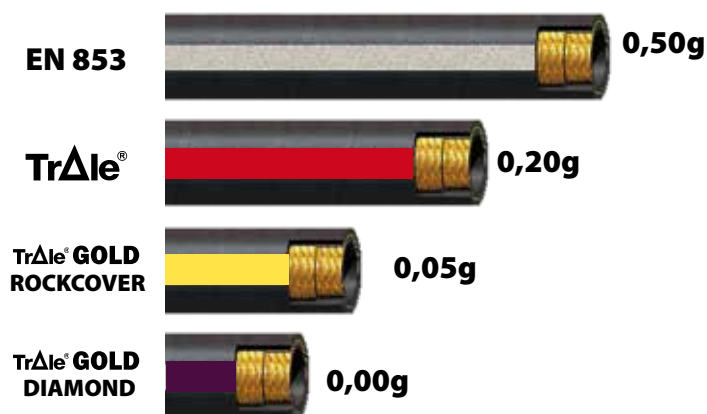

### RESISTENCIA AL OZONO (ISO 7326)

#### OZONO RESISTANCE

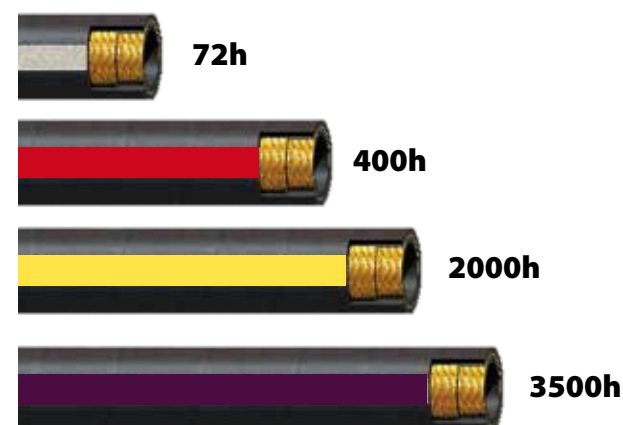

# CUBIERTA UHMPE COVER

TODOS NUESTROS MODELOS DE ROCKCOVER EN  
ALL OUR ROCKCOVER RANGE AVAILABLE WITH

# DIAMOND COVER

# Mangueras hidráulicas TrΔle GOLD

Hydraulic hoses TrΔle GOLD

Tuyaux hydrauliques TrΔle GOLD

Tubi idraulici TrΔle GOLD

## Manguera TrΔle Gold EN857 1SNK - HighPressure

EN857 1SNK hose TrΔle Gold - HighPressure

Tuyau TrΔle Gold EN857 1SNK - HighPressure

Tubi EN857 1SNK TrΔle Gold - HighPressure



DN	Part n° Referencia	€
1/4"	<b>MS1SNK04</b>	*
5/16"	<b>MS1SNK05</b>	*
3/8"	<b>MS1SNK06</b>	*
1/2"	<b>MS1SNK08</b>	*
5/8"	<b>MS1SNK10</b>	*
3/4"	<b>MS1SNK12</b>	*
1"	<b>MS1SNK16</b>	*

## Manguera TrΔle Gold EN857 2SNK - HighPressure

EN857 2SNK hose TrΔle Gold - HighPressure

Tuyau TrΔle Gold EN857 2SNK - HighPressure

Tubi EN857 2SNK TrΔle Gold - HighPressure



DN	Part n° Referencia	€
1/4"	<b>MS2SNK04</b>	<b>9,51</b>
5/16"	<b>MS2SNK05</b>	<b>10,23</b>
3/8"	<b>MS2SNK06</b>	<b>11,01</b>
1/2"	<b>MS2SNK08</b>	<b>12,96</b>
5/8"	<b>MS2SNK10</b>	<b>17,72</b>
3/4"	<b>MS2SNK12</b>	<b>20,39</b>
1"	<b>MS2SNK16</b>	<b>30,03</b>

## FLEXLINE 6000

FLEXLINE 6000

FLEXLINE 6000

FLEXLINE 6000



DN	Part n° Referencia	€	
3/8"	6	<b>MFLEX6006</b>	*
1/2"	12	<b>MFLEX6008</b>	*
5/8"	16	<b>MFLEX6010</b>	*
3/4"	19	<b>MFLEX6012</b>	*
1"	25	<b>MFLEX6016</b>	*
1"1/4	32	<b>MFLEX6020</b>	*
1"1/2	38	<b>MFLEX6024</b>	*
2"	51	<b>MFLEX6032</b>	*

# TrAde® GOLD



RESISTENCIA ABRASIÓN  
ABRASION RESISTANCE



ALTA FLEXIBILIDAD  
HIGH FLEXIBILITY

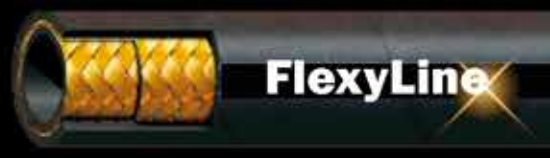

PRESIÓN +++  
+++ PRESSURE



APLICACIONES FERROVIARIAS  
RAILWAY



# Mangueras hidráulicas TrΔle

Hydraulic hoses TrΔle  
Tuyaux hydrauliques TrΔle  
Tubi idraulici TrΔle

## Manguera EN 854 R6 / SAE 100 R6

EN 854 R6 / SAE 100 R6 Hose

Tuyau EN 854 R6 / SAE 100 R6

Tubi EN 854 R6 / SAE 100 R6



DN	Part nº Referencia	€
1/4"	<b>MSB2104</b>	<b>4,34</b>
5/16"	<b>MSB2105</b>	<b>5,58</b>
3/8"	<b>MSB2106</b>	<b>6,33</b>
1/2"	<b>MSB2108</b>	<b>8,44</b>
5/8"	<b>MSB2110</b>	<b>10,07</b>
3/4"	<b>MSB2112</b>	<b>12,42</b>
1"	<b>MSB2116</b>	<b>16,72</b>

## Manguera SAE 100 R4

SAE 100 R4 Hose

Tuyau SAE 100 R4

Tubi SAE 100 R4



DN	Part nº Referencia	€
3/4"	<b>ML701019</b>	<b>13,18</b>
1"	<b>ML701025</b>	<b>18,68</b>
1"1/4	<b>ML701032</b>	<b>23,96</b>
1"1/2	<b>ML701038</b>	<b>26,81</b>
2"	<b>ML701050</b>	<b>42,24</b>
2"1/2	<b>ML701063</b>	<b>46,71</b>

## Manguera EN 854 2TE

EN 854 2TE Hose

Tuyau EN 854 2TE

Tubi EN 854 2TE



DN	Part nº Referencia	€
1/4"	<b>MB2204</b>	<b>6,22</b>
5/16"	<b>MB2205</b>	<b>7,47</b>
3/8"	<b>MB2206</b>	<b>8,01</b>
1/2"	<b>MB2208</b>	<b>9,34</b>
5/8"	<b>MB2210</b>	<b>11,20</b>
3/4"	<b>MB2212</b>	<b>13,25</b>
1"	<b>MB2216</b>	<b>17,34</b>

## Manguera SAE 100 R5

SAE 100 R5 Hose

Tuyau SAE 100 R5

Tubi SAE 100 R5



DN	Part nº Referencia	€
3/16"	<b>M250304</b>	<b>4,87</b>
1/4"	<b>M250305</b>	<b>4,87</b>
5/16"	<b>M250306</b>	<b>6,39</b>
13/32"	<b>M250308</b>	<b>6,87</b>
1/2"	<b>M250310</b>	<b>8,85</b>
5/8"	<b>M250312</b>	<b>11,24</b>
7/8"	<b>M250316</b>	<b>22,65</b>
1"1/8	<b>M250320</b>	<b>27,38</b>
1"3/8	<b>M250324</b>	<b>27,75</b>
1"13/16	<b>M250332</b>	<b>31,57</b>

## Manguera EN 854 3TE

EN 854 3TE Hose

Tuyau EN 854 3TE

Tubi EN 854 3TE



DN	Part nº Referencia	€
1/4"	<b>MB2304</b>	<b>7,15</b>
5/16"	<b>MB2305</b>	<b>7,47</b>
3/8"	<b>MB2306</b>	<b>7,96</b>
1/2"	<b>MB2308</b>	<b>9,10</b>
5/8"	<b>MB2310</b>	<b>11,05</b>
3/4"	<b>MB2312</b>	<b>13,00</b>
1"	<b>MB2316</b>	<b>17,06</b>

# Mangueras hidráulicas TrΔle

Hydraulic hoses TrΔle  
Tuyaux hydrauliques TrΔle  
Tubi idraulici TrΔle

## Manguera EN 853 1SN / SAE 100 R1AT

EN 853 1SN / SAE 100 R1AT Hose

Tuyau EN 853 1SN / SAE 100 R1AT

Tubi EN 853 1SN / SAE 100 R1AT



DN	Part nº Referencia	€
3/16"	MS223003	4,91
1/4"	MS223004	4,79
5/16"	MS223005	6,29
3/8"	MS223006	6,77
1/2"	MS223008	8,07
5/8"	MS223010	10,25
3/4"	MS223012	12,61
1"	MS223016	17,66
1"1/4"	MS223020	23,96
1"1/2"	MS223024	27,32
2"	MS223032	35,32

## Manguera EN 853 2ST / SAE 100 R2A

EN 853 2ST / SAE 100 R2A Hose

Tuyau EN 853 2ST / SAE 100 R2A

Tubi EN 853 2ST / SAE 100 R2A



DN	Part nº Referencia	€
1/4"	MS350904	6,60
5/16"	MS350905	8,67
3/8"	MS350906	9,66
1/2"	MS350908	12,20
5/8"	MS350910	15,16
3/4"	MS350912	17,65
1"	MS350916	24,20
1" 1/4"	MS350920	31,58
1" 1/2"	MS350924	37,33
2"	MS350932	50,25

## Manguera EN 853 2SN / SAE 100 R2AT

EN 853 2SN / SAE 100 R2AT Hose

Tuyau EN 853 2SN / SAE 100 R2AT

Tubi EN 853 2SN / SAE 100 R2AT



DN	Part nº Referencia	€
3/16"	MS351103	7,32
1/4"	MS351104	6,49
5/16"	MS351105	8,08
3/8"	MS351106	8,53
1/2"	MS351108	10,24
5/8"	MS351110	12,96
3/4"	MS351112	15,46
1"	MS351116	22,96
1"1/4"	MS351120	30,52
1"1/2"	MS351124	35,70
2"	MS351132	43,02
2" 1/2"	MS351140	54,01
3"	MS351148	64,55

## Manguera EN 857 1SC

EN 857 1SC Hose

Tuyau EN 857 1SC

Tubi 1SC/EN857



DN	Part nº Referencia	€
1/4"	M1SC04	5,58
5/16"	M1SC05	6,32
3/8"	M1SC06	7,06
1/2"	M1SC08	8,54
5/8"	M1SC10	9,99
3/4"	M1SC12	12,15
1"	M1SC16	15,95

## Manguera EN 857 2SC

EN 857 2SC Hose

Tuyau EN 857 2SC

Tubi 2SC/EN857



DN	Part nº Referencia	€
1/4"	M2SC04	6,88
5/16"	M2SC05	7,65
3/8"	M2SC06	8,40
1/2"	M2SC08	9,77
5/8"	M2SC10	12,89
3/4"	M2SC12	14,47
1"	M2SC16	20,32

## Manguera hidráulica 3SP

3SP Braids hoses

Tuyau 3SP

Tubi 3SP trecce



DN	Part nº Referencia	€
3/8"	MS36010600	15,66
1/2"	MS36010800	20,99
5/8"	MS36011000	24,63
3/4"	MS36011200	30,66
1"	MS36011600	42,24

# Mangueras hidráulicas TrΔle

Hydraulic hoses TrΔle  
Tuyaux hydrauliques TrΔle  
Tubi idraulici TrΔle

## Manguera EN 856 4SP / SAE 100 R9R-R10

EN 856 4SP / SAE 100 R9R-R10 Hose

Tuyau EN 856 4SP / SAE 100 R9R-R10

Tubi EN 856 4SP / SAE 100 R9R-R10



DN	Part nº Referencia	€
1/4"	<b>MS429004</b>	<b>19,84</b>
3/8"	<b>MS429006</b>	<b>22,22</b>
1/2"	<b>MS429008</b>	<b>24,61</b>
5/8"	<b>MS429010</b>	<b>29,18</b>
3/4"	<b>MS429012</b>	<b>30,47</b>
1"	<b>MS429016</b>	<b>38,85</b>
1"1/4	<b>MS424820</b>	<b>58,44</b>
1"1/2	<b>MS424824</b>	<b>70,38</b>
2"	<b>MS424832</b>	<b>81,79</b>

## Manguera EN 856 R12 / SAE 100 R12

EN 856 R12 / SAE 100 R12 Hose

Tuyau EN 856 R12 / SAE 100 R12

Tubi EN 856 R12 / SAE 100 R12



DN	Part nº Referencia	€
3/8"	<b>M461206</b>	<b>26,37</b>
1/2"	<b>M461208</b>	<b>24,46</b>
5/8"	<b>M461210</b>	<b>28,27</b>
3/4"	<b>M461212</b>	<b>32,74</b>
1"	<b>M461216</b>	<b>43,73</b>
1"1/4	<b>M461220</b>	<b>57,08</b>
1"1/2	<b>M461224</b>	<b>68,49</b>

## Manguera EN 856 4SH

EN 856 4SH Hose

Tuyau EN 856 4SH

Tubi EN 856 4SH



DN	Part nº Referencia	€
3/4"	<b>MS456912</b>	<b>33,45</b>
1"	<b>MS456916</b>	<b>44,38</b>
1"1/4	<b>MS456920</b>	<b>63,89</b>
1"1/2	<b>MS456924</b>	<b>76,95</b>
2"	<b>MS456932</b>	<b>89,42</b>

## Manguera EN 856 R13 / SAE 100 R13

EN 856 R13 / SAE 100 R13 Hose

Tuyau EN 856 R13 / SAE 100 R13

Tubi EN 856 R13 / SAE 100 R13



DN	Part nº Referencia	€
3/4"	<b>M471312</b>	<b>40,13</b>
1"	<b>M471316</b>	<b>52,82</b>
1"1/4	<b>M471320</b>	<b>81,80</b>
1"1/2	<b>M471324</b>	<b>97,61</b>
2"	<b>M471332</b>	<b>138,52</b>

## Manguera SAE 100 R15

SAE 100 R15 Hose

Tuyau SAE 100 R15

Tubi SAE 100 R15



DN	Part nº Referencia	€
1"	<b>MS481516</b>	<b>46,60</b>
1"1/4	<b>MS481520</b>	<b>96,46</b>
1"1/2	<b>MS481524</b>	<b>111,90</b>
2"	<b>MS481532</b>	<b>184,24</b>

# Mangueras hidráulicas TrΔle

Hydraulic hoses TrΔle  
Tuyaux hydrauliques TrΔle  
Tubi idraulici TrΔle

## Superservicio agua caliente 1SC negra

Hot water superservice 1SC black

Superservice eau chaude 1SC noir

Superservice acqua calda 1SC nero



DN	Part n° Referencia	€
1/4"	<b>MSC0114N</b>	<b>5,77</b>
5/16"	<b>MSC0115N</b>	<b>6,86</b>
3/8"	<b>MSC0116N</b>	<b>7,68</b>
1/2"	<b>MSC0118N</b>	<b>9,85</b>

## Superservicio agua caliente 2SC negra

Hot water superservice 2SC black

Superservice eau chaude 2SC noir

Superservice acqua calda 2SC nero



DN	Part n° Referencia	€
1/4"	<b>MSC0214N</b>	<b>6,22</b>
5/16"	<b>MSC0215N</b>	<b>8,06</b>
3/8"	<b>MSC0216N</b>	<b>9,21</b>
1/2"	<b>MSC0218N</b>	<b>11,76</b>

## Superservicio agua caliente 1SC azul

Hot water superservice 1SC blue

Superservice eau chaude 1SC bleu

Superservice acqua calda 1SC azzurro



DN	Part n° Referencia	€
1/4"	<b>MSC0114A</b>	<b>5,61</b>
5/16"	<b>MSC0115A</b>	<b>6,70</b>
3/8"	<b>MSC0116A</b>	<b>7,50</b>
1/2"	<b>MSC0118A</b>	<b>9,62</b>

## Superservicio agua caliente 2SC azul

Hot water superservice 2SC blue

Superservice eau chaude 2SC bleu

Superservice acqua calda 2SC azzurro



DN	Part n° Referencia	€
1/4"	<b>MSC0214A</b>	<b>6,78</b>
5/16"	<b>MSC0215A</b>	<b>9,28</b>
3/8"	<b>MSC0216A</b>	<b>10,47</b>
1/2"	<b>MSC0218A</b>	<b>13,28</b>

## Superservicio agua caliente 2ST azul

Hot water superservice 2ST blue

Superservice eau chaude 2ST bleu

Superservice acqua calda 2ST azzurro



DN	Part n° Referencia	€
5/16"	<b>MSC0225A</b>	<b>9,28</b>
3/8"	<b>MSC0226A</b>	<b>10,36</b>

## Superservicio agua caliente 2SC gris

Hot water superservice 2SC grey

Superservice eau chaude 2SC gris

Superservice acqua calda 2SC grigio



DN	Part n° Referencia	€
5/16"	<b>MSC0205G</b>	<b>9,04</b>
3/8"	<b>MSC0206G</b>	<b>10,40</b>

## Superservicio agua caliente 2SC azul LISA

Hot water superservice 2SC blue with SMOOTH surface

Superservice eau chaude 2SC bleu à surface LISSE

Superservice acqua calda 2SC Azzurro con superficie LISCIA



DN	Part n° Referencia	€
5/16"	<b>MSCL0215A</b>	<b>8,72</b>
3/8"	<b>MSCL0216A</b>	<b>9,69</b>

## MSCL021...

Superservicio agua caliente 2SC azul LISA

Hot water superservice 2SC blue with SMOOTH surface

**CUBIERTA LISA**  
**Más fácil de limpiar**

**SMOOTH SURFACE**  
**Easy-to-clean design**

# Mangueras hidráulicas MW - GreenLine

Hydraulic hoses MW - GreenLine

Tuyaux hydrauliques MW - GreenLine

Tubi idraulici MW - GreenLine

## Manguera EN 853 1SN / SAE 100 R1AT

EN 853 1SN / SAE 100 R1AT Hose

Tuyau EN 853 1SN / SAE 100 R1AT

Tubi EN 853 1SN / SAE 100 R1AT



DN	Part nº Referencia	€
1/4"	<b>MW223004</b>	<b>4,63</b>
5/16"	<b>MW223005</b>	<b>5,72</b>
3/8"	<b>MW223006</b>	<b>6,35</b>
1/2"	<b>MW223008</b>	<b>7,44</b>
5/8"	<b>MW223010</b>	<b>8,88</b>
3/4"	<b>MW223012</b>	<b>10,95</b>
1"	<b>MW223016</b>	<b>15,47</b>
1"1/4	<b>MW223020</b>	<b>22,62</b>

## Manguera EN 857 2SC

EN 857 2SC Hose

Tuyau EN 857 2SC

Tubi 2SC/EN857



DN	Part nº Referencia	€
1/4"	<b>MW25C04</b>	<b>6,06</b>
5/16"	<b>MW25C05</b>	<b>7,34</b>
3/8"	<b>MW25C06</b>	<b>8,16</b>
1/2"	<b>MW25C08</b>	<b>9,48</b>

## Manguera EN 856 4SP / SAE 100 R9R-R10

EN 856 4SP / SAE 100 R9R-R10 Hose

Tuyau EN 856 4SP / SAE 100 R9R-R10

Tubi EN 856 4SP / SAE 100 R9R-R10



DN	Part nº Referencia	€
3/8"	<b>MW429006</b>	<b>20,16</b>
1/2"	<b>MW429008</b>	<b>22,19</b>
5/8"	<b>MW429010</b>	<b>26,77</b>

## Manguera EN 853 2SN / SAE 100 R2AT

EN 853 2SN / SAE 100 R2AT Hose

Tuyau EN 853 2SN / SAE 100 R2AT

Tubi EN 853 2SN / SAE 100 R2AT



DN	Part nº Referencia	€
1/4"	<b>MW351104</b>	<b>6,06</b>
5/16"	<b>MW351105</b>	<b>7,34</b>
3/8"	<b>MW351106</b>	<b>8,16</b>
1/2"	<b>MW351108</b>	<b>9,48</b>
5/8"	<b>MW351110</b>	<b>11,42</b>
3/4"	<b>MW351112</b>	<b>14,43</b>
1"	<b>MW351116</b>	<b>19,40</b>
1"1/4	<b>MW351120</b>	<b>28,57</b>
1"1/2	<b>MW351124</b>	<b>33,55</b>

## Superservicio agua caliente 2SC azul

Hot water superservice 2SC blue

Superservice eau chaude 2SC bleu

Superservice acqua calda 2SC azzurro



DN	Part nº Referencia	€
5/16"	<b>MWC0215A</b>	<b>7,18</b>
3/8"	<b>MWC0216A</b>	<b>7,98</b>

## Manguera EN 856 4SH

EN 856 4SH Hose

Tuyau EN 856 4SH

Tubi EN 856 4SH



DN	Part nº Referencia	€
3/4"	<b>MW456912</b>	<b>30,48</b>
1"	<b>MW456916</b>	<b>38,95</b>
1"1/4	<b>MW456920</b>	<b>51,91</b>

# Mangueras termoplásticas TrΔle

Thermoplastic hoses TrΔle

Tuyaux thermoplastiques TrΔle

Tubi termoplastici TrΔle

## SAE 100 R7

SAE 100 R7

SAE 100 R7

SAE 100 R7



DN	Part nº Referencia	€
1/8"	MT07002	4,57
3/16"	MT07003	5,02
1/4"	MT07004	6,11
5/16"	MT07005	8,69
3/8"	MT07006	9,33
1/2"	MT07008	13,51
5/8"	MT07010	19,88
3/4"	MT07012	22,46
1"	MT07016	33,78

## SAE 100 R8

SAE 100 R8

SAE 100 R8

SAE 100 R8



DN	Part nº Referencia	€
3/16"	MT08003	9,97
1/4"	MT08004	16,67
5/16"	MT08005	18,28
3/8"	MT08006	23,94
1/2"	MT08008	31,72
5/8"	MT08010	41,12
3/4"	MT08012	52,70
1"	MT08016	75,68

## SAE 100 R7 no conductiva

SAE 100 R7 non-conductive

SAE 100 R7 non-conducteur

SAE 100 R7 non conduttivo



DN	Part nº Referencia	€
3/16"	MT07103	5,15
1/4"	MT07104	6,31
5/16"	MT07105	8,88
3/8"	MT07106	9,72
1/2"	MT07108	13,96
5/8"	MT07110	20,53
3/4"	MT07112	23,10
1"	MT07116	34,81

## Micro- Hose

Micro- Hose

Micro- Hose

Micro- Tubo



Ø INNER Ø INT.	Part nº Referencia	€
2	MT01002	3,43

## SAE 100 R7 Bitubo

SAE 100 R7 Twin

SAE 100 R7 Jumelé

SAE 100 R7 Binato



DN	Part nº Referencia	€
3/16"	MT27003	11,58
1/4"	MT27004	13,84
5/16"	MT27005	18,92
3/8"	MT27006	20,21
1/2"	MT27008	28,51

## SAE 100 R8 Bitubo

SAE 100 R8 Twin

SAE 100 R8 Jumelé

SAE 100 R8 Binato



DN	Part nº Referencia	€
1/4"	MT28004	34,94
5/16"	MT28005	38,16
3/8"	MT28006	49,55
1/2"	MT28008	65,06

## SAE 100 R8 no conductiva

SAE 100 R8 non-conductive

SAE 100 R8 non-conducteur

SAE 100 R8 non conduttivo



DN	Part nº Referencia	€
1/4"	MT08104	17,12
5/16"	MT08105	18,85
3/8"	MT08106	24,65
1/2"	MT08108	32,69
5/8"	MT08110	42,41
3/4"	MT08112	54,25
1"	MT08116	77,99

## Termoplásticas Push-on

Thermoplastic Push-on

Thermoplastique Push-on

Tubi termoplastici Push-on



DN	Part nº Referencia	€
1/4"	MP189004	6,84
3/8"	MP189006	9,25
1/2"	MP189008	15,02
5/8"	MP189010	20,12
3/4"	MP189012	24,34

# Mangueras termoplásticas TrΔle

Thermoplastic hoses TrΔle

Tuyaux thermoplastiques TrΔle

Tubi termoplastici TrΔle

## Elastómero malla metálica

Steel braid thermoplastic elastomer

Elastomère 1 tresse métallique

Treccia metallica



DN	Part nº Referencia	€
3/16"	MT09003	7,53
1/4"	MT09004	8,62
5/16"	MT09005	9,78
3/8"	MT09006	11,20
1/2"	MT09008	14,22
5/8"	MT09010	18,85
3/4"	MT09012	21,24
1"	MT09016	29,92

## Elastómero malla metálica pintura

Steel braid thermoplastic elastomer for paint

Elastomère 1 tresse métallique peinture

Treccia metallica per vernici



DN	Part nº Referencia	€
3/16"	MT099003	7,72
1/4"	MT099004	8,88
3/8"	MT099006	11,58
1/2"	MT099008	14,67
3/4"	MT099012	21,88

## Isobárica baja temperatura

Isobaric low temperature

Isobarique basse température

Isobarica bassa temperatura



DN	Part nº Referencia	€
1/4"	MT095004	14,61
3/8"	MT095006	31,08
1/2"	MT095008	41,12

## Elastómero malla metálica bitubo

Steel braid twin thermoplastic elastomer

Elastomère 1 tresse métallique jumelé

Treccia metallica Binato



DN	Part nº Referencia	€
3/16"	MT29003	16,54
1/4"	MT29004	18,79
5/16"	MT29005	21,04
3/8"	MT29006	23,94
1/2"	MT29008	29,92

## Elastómero doble malla metálica pintura

Double steel braid thermoplastic elastomer for paint

Elastomère 2 tresses métalliques peinture

Doppia treccia metallica per vernici



DN	Part nº Referencia	€
1/4"	MT299004	14,87
3/8"	MT299006	21,69
1/2"	MT299008	25,03

## Manguera termoplástica 700 bar

Thermoplastic hose 700 bar

Tuyau thermoplastique haute pression 700 bar

Tubo termoplastico 700 bar



DN	Part nº Referencia	€
1/4"	MT70004	23,10
3/8"	MT70006	54,44

## Termoplástica malla metálica para productos químicos

Steel braid elastomer for chemical products

Elastomère tresse métallique pour produits chimiques

Treccia metallica per sostanze chimiche



DN	Part nº Referencia	€
1/4"	MT096004	16,28
3/8"	MT096006	23,81
1/2"	MT096008	27,54
5/8"	MT096010	39,32
3/4"	MT096012	44,59
1"	MT096016	57,98

# Mangueras termoplásticas TrΔle

Thermoplastic hoses TrΔle

Tuyaux thermoplastiques TrΔle

Tubi termoplastici TrΔle

## Ecology 200

Ecology 200

Ecology 200

Ecology 200



DN	Part nº Referencia	€
5/8"	<b>MEC20010</b>	<b>23,10</b>
3/4"	<b>MEC20012</b>	<b>25,10</b>
1"	<b>MEC20016</b>	<b>42,47</b>
1" 1/4	<b>MEC20020</b>	<b>54,06</b>

## Ecology 250

Ecology 250

Ecology 250

Ecology 250



DN	Part nº Referencia	€
3/4"	<b>MEC25012</b>	<b>38,45</b>
1"	<b>MEC25016</b>	<b>58,00</b>

## Casquillos para manguera Ecology

Ferrules for Ecology hose

Jupes pour tuyau Ecology

Boccole pressare per tubi Ecologici

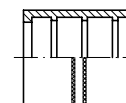

DN	Part nº Referencia	€
3/4"	<b>Z212001200</b>	*
1"	<b>Z212001600</b>	*
1"1/4	<b>Z212002000</b>	*

Acero inoxidable AISI 316-L. Ver precios en Catalogo Inox p.22 / Stainless steel AISI 316-L.  
Prices in Stainless Steel Catalogue p.22 / Acier inoxydable AISI 316-L. Prix dans le Catalogue Acier  
Inox p.22 / Acciaio inossidabile AISI 316-L. Prezzi in Acciaio Inossidabile p.22

# Mangueras PTFE TrΔle

PTFE hoses TrΔle  
Tuyaux PTFE TrΔle  
Tubi PTFE TrΔle

## PTFE sin malla

PTFE without braid

PTFE sans tresse

PTFE senza treccia



PIPE TUBO	LENGTH (M) LONGITUD (M)	Part n° Referencia	€
2x4	25	<b>M2950204</b>	<b>85,73</b>
4x6	25	<b>M2950406</b>	<b>125,94</b>
6x8	25	<b>M2950608</b>	<b>182,17</b>
2x4	100	<b>M2950204-100</b>	<b>342,92</b>
4x6	100	<b>M2950406-100</b>	<b>503,66</b>
6x8	100	<b>M2950608-100</b>	<b>728,70</b>

€/ rollo / €/ roll / €/rouleau / €/rotolo

## PTFE Liso 1 malla SAE100 R14

FHL (light) / Smooth PTFE SAE100 R14

FHL (série légère) SAE100 R14

FHL (serie leggera) SAE 100 R14



DN	Part n° Referencia	€
1/8"	<b>M290003</b>	<b>11,03</b>
3/16"	<b>M290005</b>	<b>11,79</b>
1/4"	<b>M290006</b>	<b>11,72</b>
5/16"	<b>M290008</b>	<b>15,74</b>
3/8"	<b>M290009</b>	<b>15,74</b>
1/2"	<b>M290013</b>	<b>21,57</b>
5/8"	<b>M290016</b>	<b>31,27</b>
3/4"	<b>M290020</b>	<b>38,83</b>
1"	<b>M290025</b>	<b>62,75</b>

## PTFE Liso grueso 2 mallas

FHM 2 Braids

FHM 2 tresses

FHM doppia treccia



DN	Part n° Referencia	€
1/4"	<b>M2901206</b>	<b>21,36</b>
5/16"	<b>M2901208</b>	<b>25,31</b>
3/8"	<b>M2901209</b>	<b>28,98</b>
1/2"	<b>M2901213</b>	<b>39,32</b>
5/8"	<b>M2901216</b>	<b>53,53</b>
3/4"	<b>M2901219</b>	<b>62,82</b>
1"	<b>M2901225</b>	<b>85,70</b>

## PTFE corrugado 1 malla

Convuluted PTFE 1 braid

PTFE convoluté 1 tresse

PTFE corrugato 1 maglia



DN	Ø Inner Min. Ø INT. MIN.	Ø Inner Max. Ø INT. MAX.	Ø Out Min Ø EXT. MIN.	Ø OUT MAX Ø EXT. MÁX.	Part n° Referencia	€
1/4"	5,95	6,45	9,14	9,65	<b>M292006</b>	<b>28,11</b>
3/8"	10	11	14,7	16,2	<b>M292009</b>	<b>36,26</b>
1/2"	13	14	18	19,7	<b>M292013</b>	<b>39,14</b>
5/8"	16	17	21,5	23	<b>M292016</b>	<b>48,19</b>
3/4"	19,5	20,7	25	27,5	<b>M292020</b>	<b>56,37</b>
1"	25,4	26,8	32	34,3	<b>M292025</b>	<b>80,02</b>
1" 1/4	31,5	33	38,5	41	<b>M292032</b>	<b>128,56</b>
1" 1/2	38	40	44,5	48	<b>M292038</b>	<b>163,62</b>
2"	50,5	52,7	57	62	<b>M292050</b>	<b>214,97</b>

## PTFE corrugado con fibra de vidrio 1 malla

Convuluted PTFE with fiberglass 1 braid

PTFE convoluté avec fibre de verre 1 tresse

PTFE con fibra di vetro 1 maglia



DN	Part n° Referencia	€
3/8"	<b>M298009</b>	<b>71,99</b>
1/2"	<b>M298013</b>	<b>96,49</b>
3/4"	<b>M298020</b>	<b>127,31</b>
1"	<b>M298025</b>	<b>169,55</b>
1" 1/4	<b>M298032</b>	<b>200,98</b>

## PTFE corrugado anti-estático 1 malla

Anti-static convuluted PTFE 1 braid

PTFE convoluté anti-statique 1 tresse

PTFE corrugato anti-statico 1 maglia



DN	Ø Inner Min. Ø INT. MIN.	Ø Inner Max. Ø INT. MAX.	Ø Out Min Ø EXT. MIN.	Ø OUT MAX Ø EXT. MÁX.	Part n° Referencia	€
3/8"	10	11	14,7	16,2	<b>M293009</b>	<b>50,20</b>
1/2"	13	14	18	19,7	<b>M293013</b>	<b>56,73</b>
3/4"	19,5	20,7	25	27,5	<b>M293020</b>	<b>77,38</b>
1"	25,4	26,8	32	34,3	<b>M293025</b>	<b>103,35</b>

# Mangueras PTFE TrΔle

PTFE hoses TrΔle  
Tuyaux PTFE TrΔle  
Tubi PTFE TrΔle

Hoses

Flexible hose fittings

Flow measuring

Equipment for flexible hoses

## PTFE Liso PTFLEX

PTFLEX Smooth PTFE

PTFE Lisse PTFLEX

PTFE Liscio PTFLEX



DN	Part nº Referencia	€
3/4"	<b>M294020</b>	*
1"	<b>M294025</b>	*
1"1/4	<b>M294032</b>	*

## PTFLEX | Lo mejor del PTFE corrugado y liso The best of convoluted & smoothbore hose

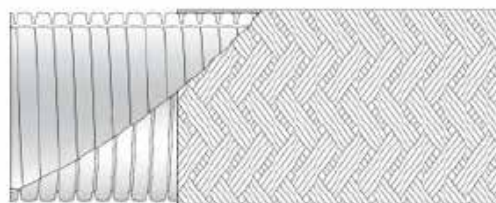

Diseño híbrido entre manguera corrugada y lisa, del cual se obtienen las ventajas y beneficios de ambas: **Flexibilidad**, el **flujo continuo** y la **facilidad de limpieza interior**, todo en una manguera de PTFE.

\* Opción antiestática bajo consulta.

As a hybrid of both traditional Convoluted & Smoothbore hose designs you gain the advantages and benefits of **flexibility**, **flow rates** and **cleanability** all in one PTFE hose.

\* Antistatic option on request

## SISTEMAS DE FRENADO MOTORCYCLE BRAKING SYSTEMS

Consultar | On request

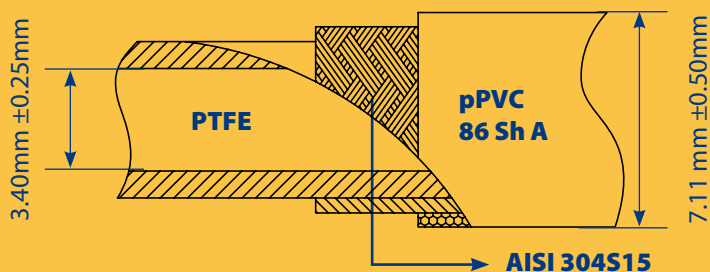

321 BAR



966 BAR



38mm



-10° to  
+70°C\*

\*Limitado por la cubierta de PVC | Limited by PVC Cover

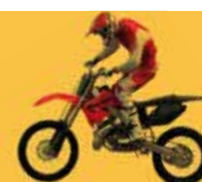

# Racores para tubería flexible

*Flexible hose fittings*

Embouts à sertir

*Raccordi per tubi flessibili*

## Conexiones Serie Standard

*Standard series fittings*  
Embouts série Standard  
*Raccordi serie Standard*

42

## Conexiones Serie Reusables

*Reusable series fittings*  
Embouts Récuperables  
*Raccordi serie Recuperabile*

60

## Conexiones Serie BW no pelar R12 / 4SP / 4SH

*BW fittings - no skiving R12 / 4SP / 4SH*  
Embouts BW sans dénuder R12 / 4SP / 4SH  
*Raccordi BW - senza pelatura R12 / 4SP / 4SH*

61

## Conexiones Serie Interlock

*Interlock series fittings*  
Embouts à sertir Interlock  
*Raccordi serie Interlock*

64

## Conexiones Alta presión (700 Bar)

*High pressure 700 Bar fittings*  
Embouts haute pression 700 Bar  
*Raccordi altissima pressione (700 Bar)*

70

## Conexiones Serie 43 una sola pieza 1SN / 2SN / R16 / 2SC / 3TE / R17

*One piece fittings 43 Series 1SN / 2SN / R16 / 2SC / 3TE / R17*  
Embouts pré-sertis Série 43 1SN / 2SN / R16 / 2SC / 3TE / R17  
*Raccordi un pezzo Serie 43 1SN / 2SN / R16 / 2SC / 3TE / R17*

72

## Conexiones Serie BW una sola pieza R12 / 4SP / 4SH

*One piece fittings BW series R12 / 4SP / 4SH*  
Embouts pré-sertis Série BW R12 / 4SP / 4SH  
*Raccordi BW - 1 pezzo R12 / 4SP / 4SH*

86

2

TrΔle®

TrΔle® GOLD

GREENLINE

■ Una única conexión para una amplia gama de mangueras

*One only fitting for a big hose range*

*Un seul raccord pour une grande gamme de tuyaux*

*Un solo raccordo per una vasta gamma di tubi*

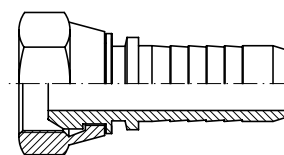

SAE 100 R6	EN 854 2TE	EN 854 3TE	EN 857 1SC SUPERSERVICE 15C 155°	EN 853 15N SAE 100 R1AT 15NK	EN 853 25N SAE 100 R2AT 25NK	EN 857 25C SUPERSERVICE 25C 155°
DI23	DI23	DI2212	SC2112...	SC2112 DI2212	DI2212	DI2212

SAE 100 R7 EN 855 No conductiva	SAE 100 R8 EN 855 No conductiva	Metallic braid elastomer solvent	Metallic 2 braid elastomer solvent	Smooth PTFE 1 braid	Smooth PTFE 2 braid	Convoluted PTFE Std.   Fiberglass   Antistatic
DI23	DI23	DI23	DI1224	21040	21045	21041

EN 853 2ST SAE100 R2A	EN 856 4SP SAE 100 R9R	EN 856 R12 SAE 100	3SP EN856 4SP - 4SH - R12 SAE 100 R9R	Ecology 200	Ecology 250
DI1224	DI1224	DI1224	DI2224	Z2120...	Z2120...

Datos de tablas de prensado siempre actualizados en nuestra web: [www.dicsaes.com](http://www.dicsaes.com) / Crimping information always updated on our: [website www.dicsaes.com](http://www.dicsaes.com)

Consulta nuestras mangueras con cubiertas Gold RockCover / Check our Hoses with Gold RockCover

Hoses

Flexible hose fittings

Flow measuring

Equipment for flexible hoses

## Serie Interlock

Interlock serie  
Série Interlock  
Serie Interlock

TrAie®

TrAie® GOLD

GREENLINE

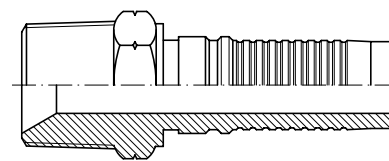

■ Una única conexión para toda la gama de mangueras de alta presión

*One only fitting for all very high pressure hoses*

*Un seul raccord pour tous les tubes de très haute pression*

*Un solo raccordo per tutti i tubi ad altissima pressione*



EN 856  
4SH

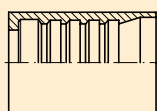

A61010



EN 856  
R13  
SAE 100

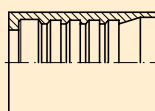

A61010  
61010



SAE 100  
R15

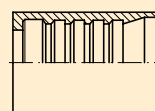

A61010  
61010

## Serie BW no pelar

*BW Series no skiving*

*Série BW sans dénuder*

*Serie BW senza spellatura*

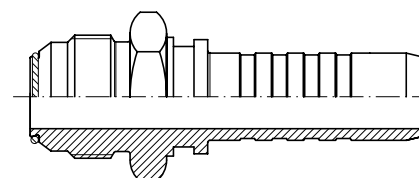

EN 856  
4SP  
SAE 100

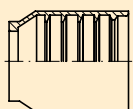

AC68010



EN 856  
4SH

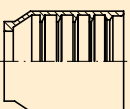

AC68010



EN 856  
R12  
SAE 100

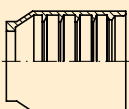

AC68010

# Conexiones Serie Standard

Standard series fittings  
 Embouts série Standard  
 Raccordi serie Standard

■ Casquillos para prensar / Crimping ferrules / Jupes à serrer / Boccole a pressare

42

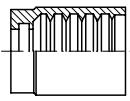

DI2212

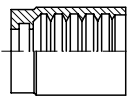

DI2212...R4

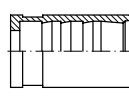

DI2300

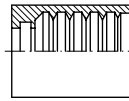

SC2112

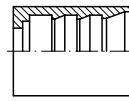

DI1224

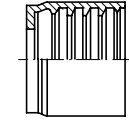

DI22240

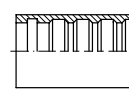

21040

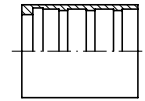

21045

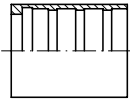

21041

■ Conexiones BSP/BSPT / BSP/BSPT Fittings / Embouts BSP/BSPT / Raccordi BSP/BSPT

44

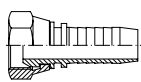

24100

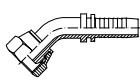

24108

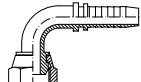

24107

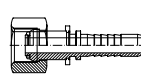

24110...L

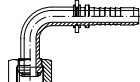

24117...L

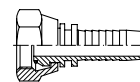

24110

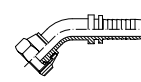

24118

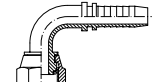

24117



24400

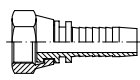

24200

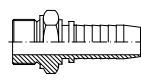

24212

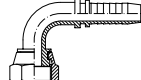

24207

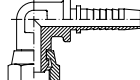

24127

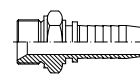

24112

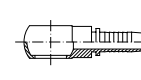

24111

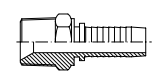

24114

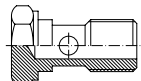

A1090

■ Conexiones JIC 37° / JIC 37° Fittings / Embouts JIC 37° / Raccordi JIC 37°

48



24142



24242

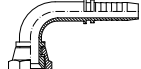

24138

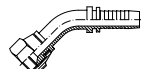

24139



24140



24300

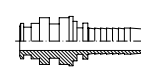

24190

■ Conexiones Métricas DIN 2353 / Metric fittings DIN 2353 / Embouts Métriques DIN 2353 / Raccordi Metrici DIN 2353

50

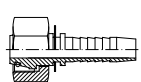

24804

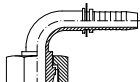

24305

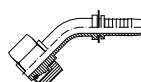

24306

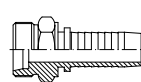

24203

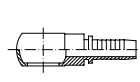

24116

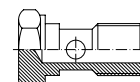

S1092

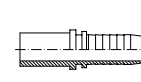

24158



24404

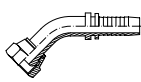

24406

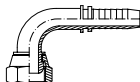

24405

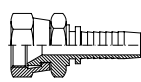

2580496

# Conexiones Serie Standard

Standard series fittings  
 Embouts série Standard  
 Raccordi serie Standard

## ■ Conexiones NPT/NPSM /NPT/NPSM Fittings /Embouts NPT/NPSM /Raccordi NPT/NPSM

54

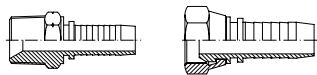

24161

24261

## ■ Conexiones Métricas Serie Francesa /Metric fittings French Serie /Embouts Métriques Série Française /Raccordi Metrici Serie Francese

54

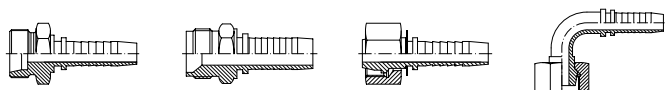

24503

2450518

24504

24505

## ■ Conexiones ORFS /ORFS Fittings /Embouts ORFS /Raccordi ORFS

55



44900

44912

JUNTAS

44907

44908

## ■ Bridas SAE 3000/6000/9000 PSI /3000/6000 PSI SAE Flanges /Brides SAE 3000/6000 PSI /Flangia SAE 3000/6000 PSI

56

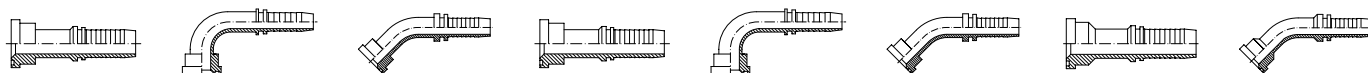

24182

24183

24184

24282

24283

24284

44282

44284

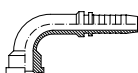

44283

## ■ Bridas fijación SAE /SAE Flanges /Brides SAE /Flangia SAE

58



BBP

BBE

TBSAE

JBR

JUNTAS

## ■ Racores para hidrolavadoras /Karcher fittings /Embouts Karcher /Raccordi per idropulitrici

59



23040

2307

23060

23061

23062

## ■ Conexiones CO2 /CO2 Fittings /Embouts CO2 /Raccordi CO2

59



24704

# Conexiones Serie Reusables

Reusable series fittings  
 Embouts Récuperables  
 Raccordi serie Recuperabile

## ■ Casquillos / Ferrules / Jupes / Boccole recuperabili

60

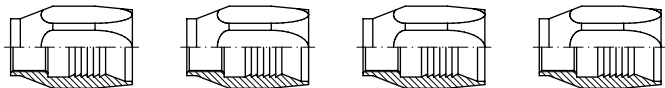

A1G...R1

A1G...R1T

A1G...R2

A1G...R2T

## ■ Conexiones / Fittings / Embouts / Raccordi recuperabili

60

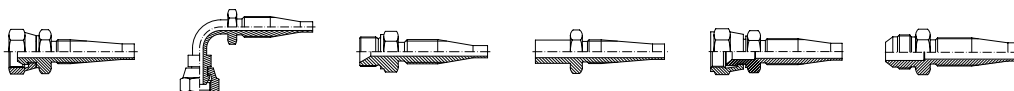

A3G

A90G

A2G

AE

A3J

A2J

## Conexiones Serie BW no pelar R12 / 4SP / 4SH

*BW fittings - no skiving R12 / 4SP / 4SH*

*Embouts BW sans dénuder R12 / 4SP / 4SH*

*Raccordi BW - senza pelatura R12 / 4SP / 4SH*

- Casquillos R12/ 4SP/ 4SH serie BW / Ferrules R12/4SP/4SH BW series / Jupes à sertir R12/4SP/4SH série BW / Boccole pressare R12/4SP/4SH serie BW | 61

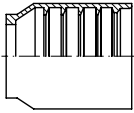

AC68010

- Conexiones BSP / BSP Fittings / Embouts BSP / Raccordi BSP | 61



66110

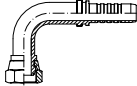

66117

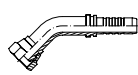

66118



66112

- Conexiones JIC 37° / JIC 37° Fittings / Embouts JIC 37° / Raccordi JIC 37° | 61

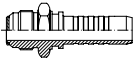

66140



66242

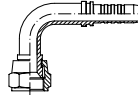

66138



66139

- Conexiones Métricas DIN 2353 / Metric fittings / Embouts Métriques / Raccordi Metrici | 62

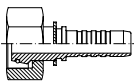

66204

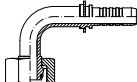

66205

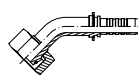

66206

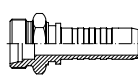

66203

- Bridas SAE 3000/6000 PSI / SAE Flanges 3000/6000 PSI / Brides SAE 3000/6000 PSI / Flangia SAE 3000/6000 PSI | 62

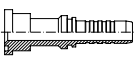

66182



66183

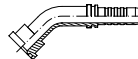

66184



66282



66283

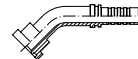

66284

- Conexiones ORFS / ORFS Fittings / Embouts ORFS / Raccordi ORFS | 63



66901



66907

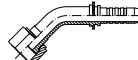

66908

# Conexiones Serie Interlock

Interlock series fittings  
 Embouts à sertir Interlock  
 Raccordi serie Interlock

## ■ Casquillos / Crimping ferrules / Jupes / Boccole a pressare

64

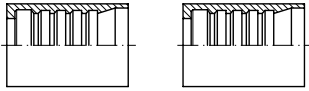

A61010

61010

## ■ Conexiones BSP / BSP Fittings / Embouts BSP / Raccordi BSP

64

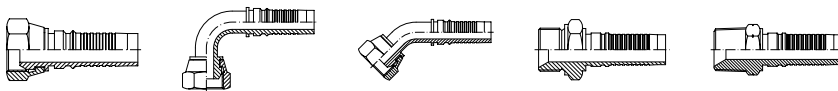

64100

64107

64108

64112

64161

## ■ Conexiones JIC 37° / JIC 37° Fittings / Embouts JIC 37° / Raccordi JIC 37°

65

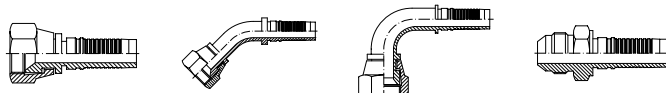

64142

64139

64138

64140

## ■ Conexiones Métricas DIN 2353 / Metric fittings DIN 2353 / Embouts Métriques DIN 2353 / Raccordi Metrici DIN 2353

65

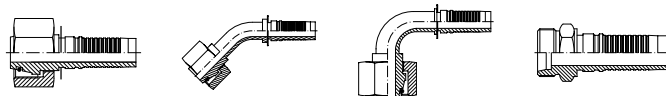

64204

64206

64205

64203

## ■ Racores para martillo / Fittings for hammer / Embouts pour marteau / Raccordi per martello

66

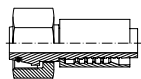

NAM

## ■ Conexiones ORFS / ORFS fittings / Embouts ORFS / Raccordi ORFS

66

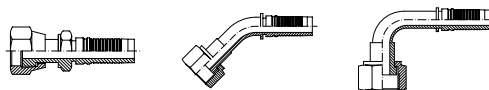

64900

64908

64907

## ■ Bidas SAE 3000/6000 PSI / 3000/6000 PSI SAE Flanges / Embouts brides SAE 3000/6000 PSI / Flangia SAE 3000/6000 PSI

67

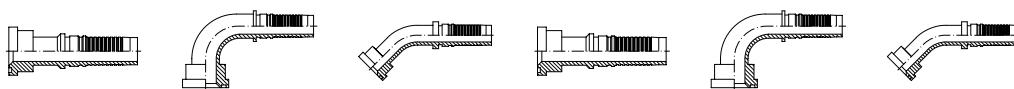

64182

64183

64184

64282

64283

64284

## ■ Bidas 9000 PSI / 9000 PSI Flanges / Embouts brides 9000 PSI / Flangia 9000 PSI

68

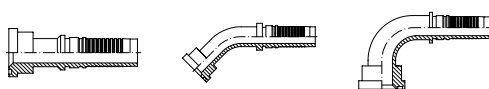

64382

64384

64383

## Conexiones Serie Interlock

*Interlock series fittings*  
 Embouts à sertir Interlock  
 Raccordi serie Interlock

- Bridas Poclairn / Poclairn flanges / Embouts brides Poclairn / Flangia Poclairn

| 69

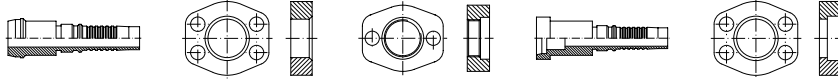

64801

44805

44807

64802

44806

## Conexiones Alta presión (700 Bar)

*High pressure 700 Bar fittings*  
 Embouts haute pression 700 Bar  
 Raccordi altissima pressione (700 Bar)

- Casquillos / Ferrules / Jupes à sertir / Boccole

| 70

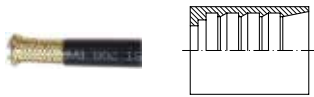

MT700

71012

- Conexiones / Fittings / Embouts / Raccordi

| 70

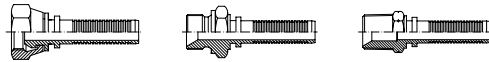

74100

74112

74161

# Conexiones Serie 43 una sola pieza 1SN / 2SN / R16 / 2SC / 3TE / R17

One piece fittings 43 Series 1SN / 2SN / R16 / 2SC / 3TE / R17

Embouts pré-sertis Série 43 1SN / 2SN / R16 / 2SC / 3TE / R17

Raccordi un pezzo Serie 43 1SN / 2SN / R16 / 2SC / 3TE / R17

- Casquillos para racores de una sola pieza / Ferrules for one piece fittings / Jupes pour embouts pré-sertis / Boccole per raccordi un pezzo | 72

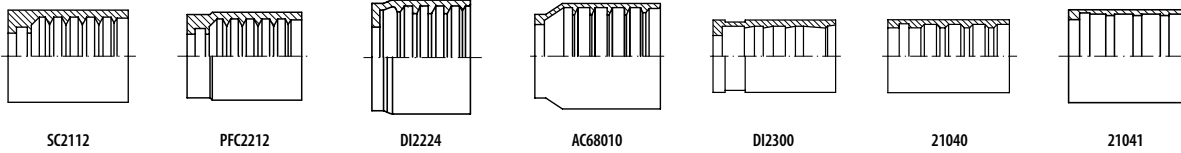

SC2112

PFC2212

DI2224

AC68010

DI2300

21040

21041

- Conexiones una sola pieza JIC 37° / One piece JIC 37° fittings / Embouts pré-sertis JIC 37° / Raccordi un pezzo JIC 37° | 74

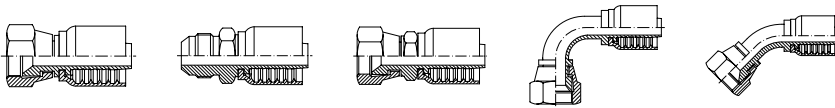

28142

28140

28242

28138

28139

- Conexiones una sola pieza NPT-NPSM / One piece NPT-NPSM fittings / Embouts pré-sertis NPT-NPSM / Raccordi un pezzo NPT-NPSM | 75

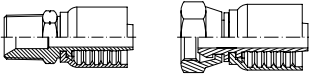

28161

28261

- Conexiones una sola pieza ORFS / One piece ORFS fittings / Embouts pré-sertis ORFS / Raccordi un pezzo ORFS | 76

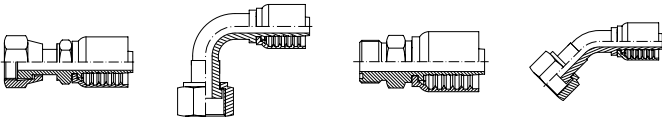

28900

28907

28912

28908

- Conexiones una sola pieza Bridas SAE 3000/6000 PSI / One piece SAE Flanges fittings 3000/6000 PSI / Embouts pré-sertis Brides SAE 3000/6000 PSI / Raccordi un pezzo Flange SAE 3000/6000 PSI | 77

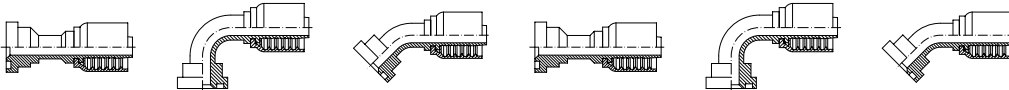

28182

28183

28184

28282

28283

28284

- Conexiones una sola pieza Bridas SAE 9000 PSI / One piece SAE Flanges fittings 9000 PSI / Embouts pré-sertis Brides SAE 9000 PSI / Raccordi un pezzo Flange SAE 9000 PSI | 78

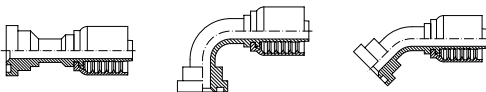

48282

48283

48284

- Conexiones una sola pieza Métricas / One piece Metric fittings / Embouts pré-sertis Métriques / Raccordi un pezzo Metrici | 79

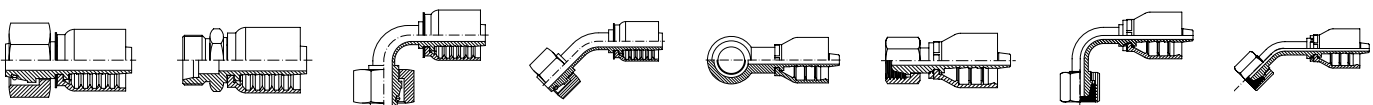

28804

28203

28305

28306

28116

28404

28405

28406

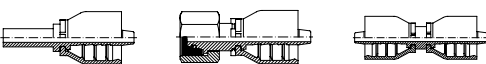

28158

28804

28300

# Conexiones Serie 43 una sola pieza 1SN / 2SN / R16 / 2SC / 3TE / R17

*One piece fittings 43 Series 1SN / 2SN / R16 / 2SC / 3TE / R17*

*Embouts pré-sertis Série 43 1SN / 2SN / R16 / 2SC / 3TE / R17*

*Raccordi un pezzo Serie 43 1SN / 2SN / R16 / 2SC / 3TE / R17*

■ Conexiones una sola pieza BSP - BSPT / One piece BSP - BSPT fittings / Embouts pré-sertis BSP - BSPT / Raccordi un pezzo BSP - BSPT | 82

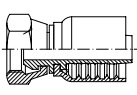

28100

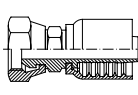

28400

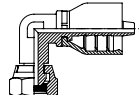

28127

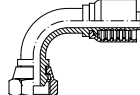

28107

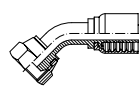

28108

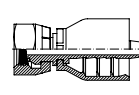

28110

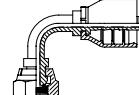

28117

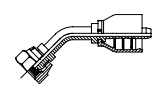

28118

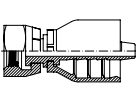

28200

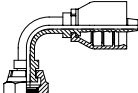

28207

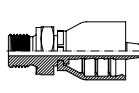

28212

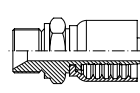

28112

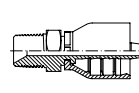

28114

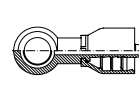

28111

# Conexiones Serie BW una sola pieza R12 / 4SP / 4SH

*One piece fittings BW series R12 / 4SP / 4SH*

*Embouts pré-sertis Série BW R12 / 4SP / 4SH*

*Raccordi BW - 1 pezzo R12 / 4SP / 4SH*

## ■ Conexiones JIC 37° / JIC 37° Fittings / Embouts JIC 37° / Raccordi JIC 37°

86

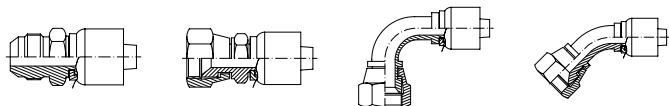

68140

68242

68138

68139

## ■ Conexiones ORFS / ORFS Fittings / Embouts ORFS / Raccordi ORFS

86

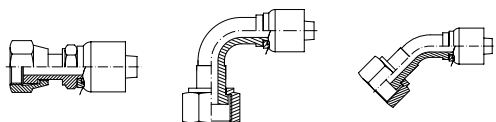

68901

68907

68908

## ■ Bridas SAE 3000/6000 PSI / SAE Flanges 3000/6000 PSI / Brides SAE 3000/6000 PSI / Flangia SAE 3000/6000 PSI

87

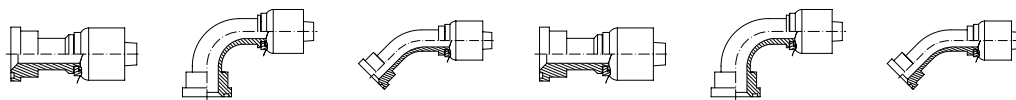

68182

68183

68184

68282

68283

68284

## ■ Conexiones Métricas DIN 2353 / Metric fittings / Embouts Métriques / Raccordi Metrici DIN 2353

88

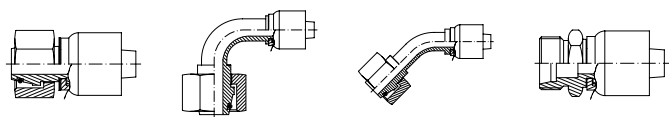

68204

68205

68206

68203

## ■ Conexiones BSP / BSP Fittings / Embouts BSP / Raccordi BSP

88

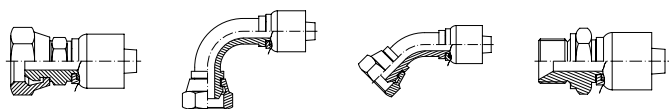

68110

68107

68108

68112

# Conexiones Serie Standard

Standard series fittings  
Embouts série Standard  
Raccordi serie Standard

## Casquillos R1AT/R2AT/1SN/2SN/2SC/R16/3TE

Ferrules R1AT/R2AT/1SN/2SN/2SC/R16/3TE

Jupes à sertir R1AT/R2AT/1SN/2SN/2SC/R16/3TE

Boccole a pressione per R1AT/R2AT/1SN/2SN/2SC/R16/3TE

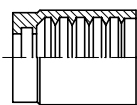

DN	Part nº Referencia	€
3/16"	DI221200300	1,18
1/4"	DI221200400	0,96
5/16"	DI221200501	0,96
3/8"	DI221200600	1,11
1/2"	DI221200800	1,30
5/8"	DI221201000	1,76
3/4"	DI221201200	2,62
1"	DI221201600	5,35
1"1/4	DI221202000	14,45
1"1/2	DI221202400	20,83
2"	DI221203200	25,59
2" 1/2	DI221204000	39,25
3"	DI221204800	47,69

## Casquillos R4

Ferrules R4

Jupes à sertir R4

Boccole a pressione per R4

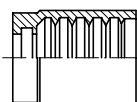

DN	Part nº Referencia	€
3/4"	DI221201200R4	7,40

Para otros tamaños, consultar tabla de prensado en nuestra web. / For other sizes, please check out the crimping table on our website. / Pour les autres dimensions, voir tableau de sertissage disponible sur notre site web. / Per altre dimensioni, vedere tabella di pressatura nel ns. sito web

## Casquillos R6, R7, R8 y malla metálica

Ferrules SAE 100 R6, R7, R8 and steel braid

Jupes à sertir R6, R7, R8 et tresse métallique

Boccole a pressione per SAE R6, R7, R8 e Treccia Metallica

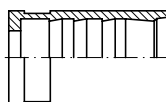

DN	Part nº Referencia	€
1/8"	DI2300200	1,05
3/16"	DI2300300	0,84
1/4"	DI2300400	0,80
5/16"	DI2300500	1,47
3/8"	DI2300600	1,19
1/2"	DI2300800	1,53
5/8"	DI2301000	2,82
3/4"	DI2301200	4,56
1"	DI2301600	7,89

## Casquillos 1SC/1SN/2SC/R6/2TE

Ferrules 1SC/1SN/2SC/R6/2TE

Jupes à sertir 1SC/1SN/2SC/R6/2TE

Boccole a pressione per 1SC/1SN/2SC/R6/2TE

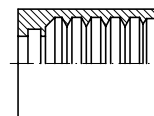

DN	Part nº Referencia	€
1/4"	SC21120400	1,23
5/16"	SC21120500	1,10
3/8"	SC21120600	1,32
1/2"	SC21120800	1,91
5/8"	SC21121000	2,60
3/4"	SC21121200	3,39
1"	SC21121600	5,83

## Casquillos R2A/R9R/2ST/4SP

Ferrules R2A/R9R/2ST/4SP

Jupes à sertir R2A/R9R/2ST/4SP

Boccole a pressione per R2A/R9R/2ST/4SP

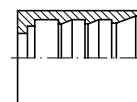

DN	Part nº Referencia	€
1/4"	DI122400400	1,24
5/16"	DI122400500	1,65
3/8"	DI122400600	1,44
1/2"	DI122400800	1,95
5/8"	DI122401000	2,49
3/4"	DI122401200	3,99
1"	DI122401600	6,28
1"1/4	DI122402000	14,77
1"1/2	DI122402400	17,61
2"	DI122403200	29,65

## Casquillos R12/3SP/4SP/4SH no pelar

Ferrules R12/3SP/4SP/4SH non skive

Jupes à sertir R12/3SP/4SP/4SH sans dénudage

Boccole a pressione per R12/3SP/4SP/4SH senza spellatura

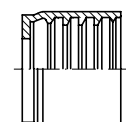

DN	Part nº Referencia	€
3/8"	DI222400600	2,19
1/2"	DI222400800	2,58
5/8"	DI222401000	3,31
3/4"	DI222401200	4,43
1"	DI222401600	7,23
1" 1/4	DI222402000	*

■ **CASQUILLO:** Reduce costes y tiempo de montaje

■ **FERRULES:** Simplify assembly and save money

**NO PELAR | NO SKIVING**  
**3SP | 4SP | R12 | 4SH**

**ESPIGA STANDARD | STANDARD SERIES**



+



DI2224...

Consulta en nuestra ficha técnica datos | Check our technical sheet for data

\* Consultar / \*On request / \*Sur demande / \*Su richiesta

# Conexiones Serie Standard

Standard series fittings  
Embouts série Standard  
Raccordi serie Standard

Hoses

Flexible hose fittings

Flow measuring

Equipment for flexible hoses

## Casquillos PTFE Liso alta presión SAE 100 R14

Ferrules for Smooth PTFE SAE 100 R14

Jupes à sertir pour PTFE Lisse haute pression SAE 100 R14

Boccole a pressare per tubo al PTFE Liscio alta pressione SAE 100 R14

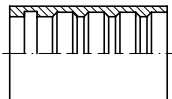

DN	Part nº Referencia	€
3/16"	210400300	1,37
1/4"	210400400	1,02
5/16"	210400500	1,43
3/8"	210400600	1,24
1/2"	210400800	1,67
5/8"	210401000	2,18
3/4"	210401200	2,84
1"	210401600	5,11

## Casquillos PTFE liso doble malla alta presión

Ferrules for Smooth PTFE high pressure hose with two braids

Jupes à sertir pour PTFE Lisse double tresse haute pression

Boccole a pressare per tubo al PTFE Liscio doppia treccia alta pressione

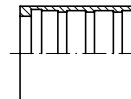

DN	Part nº Referencia	€
1/4"	210450400	0,97
3/8"	210450600	1,11

Para otros tamaños, consultar tabla de prensado en nuestra web. / For other sizes, please check out the crimping table on our website. / Pour les autres dimensions, voir tableau de sertissage disponible sur notre site web. / Per altre dimensioni, vedere tabella di pressatura nel ns. sito web

## Casquillos PTFE Corrugado alta presión

Ferrules for Convoluted PTFE

Jupes à sertir PTFE Convoluté haute pression

Boccole a pressare per tubo al PTFE Corrugato alta pressione

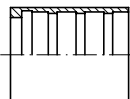

DN	Part nº Referencia	€
1/4"	210410400	1,38
3/8"	210410600	1,59
1/2"	210410800	1,78
5/8"	210411000	3,11
3/4"	210411201	3,19
1"	210411600	5,45
1" 1/4	210412001	11,55
1" 1/2	210412400	13,51
2"	210413200	23,06



### SAE 100 R4

3/4"	1"	1" 1/4 1" 1/2 2"
DI2212...R4	DI2212...	DI1224...

### PTFE 2 MALLAS | FHM 2 BRAIDS

1/4" 3/8"	5/16" 3/4" 1"	1/2" 5/8"
21045...	DI23...	21040...

Datos de tablas de prensado siempre actualizados en nuestra web: [www.dicsaes.com](http://www.dicsaes.com) / Crimping information always updated on our website [www.dicsaes.com](http://www.dicsaes.com)

# Conexiones Serie Standard

Standard series fittings  
Embouts série Standard  
Raccordi serie Standard

## Hembras giratorias rectas BSP cono 60°

BSP Swivel female 60° cone

Femelle tournante gaz cyl BSP 60°

Femmina diritta BSP sede 60°

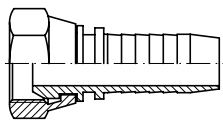

DN	THREAD ROSCA	Part nº Referencia	€
1/8"	1/8" BSP	241000202	1,62
3/16"	1/8" BSP	241000203	1,34
1/4"	1/8" BSP	241000204	1,65
3/16"	1/4" BSP	241000403	1,68
1/4"	1/4" BSP	241000404	1,34
5/16"	1/4" BSP	241000405	1,72
3/8"	1/4" BSP	241000406	2,15
1/4"	3/8" BSP	241000604	1,99
5/16"	3/8" BSP	241000605	1,85
3/8"	3/8" BSP	241000606	1,73
1/2"	3/8" BSP	241000608	2,22
1/4"	1/2" BSP	241000804	2,64
3/8"	1/2" BSP	241000806	2,42
1/2"	1/2" BSP	241000808	2,34
5/8"	1/2" BSP	241000810	3,47
1/2"	5/8" BSP	241001008	3,69
5/8"	5/8" BSP	241001010	3,32
1/2"	3/4" BSP	241001208	4,33
5/8"	3/4" BSP	241001210	4,00
3/4"	3/4" BSP	241001212	4,18
3/4"	1" BSP	241001612	7,22
1"	1" BSP	241001616	7,01
2"	2" 1/2 BSP	241004032	62,26
2" 1/2	2" 1/2 BSP	241004040	62,26
3"	3" BSP	241004848	71,83

Para medidas de 1" 1/4, 1" 1/2 y 2" ver con junta / For sizes of 1" 1/4, 1" 1/2 y 2" see with o'ring / Pour les dimensions de 1" 1/4, 1" 1/2 y 2" voir avec o'ring / Per quelli di 1" 1/4, 1" 1/2 y 2" vedere con o'ring

## Hembras giratorias 45° BSP cono 60°

BSP Swivel female 60° cone (45° Elbow)

Coude 45° femelle tournante gaz cyl BSP 60°

Femmina a 45° BSP sede 60°

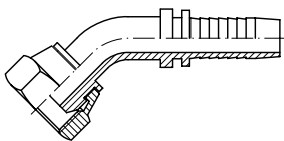

DN	THREAD ROSCA	Part nº Referencia	€
3/16"	1/8" BSP	241080203	2,93
1/4"	1/8" BSP	241080204	2,12
3/16"	1/4" BSP	241080403	2,93
1/4"	1/4" BSP	241080404	2,27
1/4"	3/8" BSP	241080604	3,58
5/16"	3/8" BSP	241080605	3,38
3/8"	3/8" BSP	241080606	3,21
3/8"	1/2" BSP	241080806	4,37
1/2"	1/2" BSP	241080808	4,61
1/2"	5/8" BSP	241081008	6,86
5/8"	5/8" BSP	241081010	6,86
5/8"	3/4" BSP	241081210	8,27
3/4"	3/4" BSP	241081212	8,83
3/4"	1" BSP	241081612	14,80
1"	1" BSP	241081616	13,78

Para aquellas mayores de 1" ver con junta / For those bigger than 1" see with o'ring / Pour ceux plus grand que 1" voir avec o'ring / Per quelli più grandi di 1" vedere con o'ring

## Hembras giratorias 90° BSP cono 60°

BSP Swivel female 60° cone (90° Elbow)

Coude 90° femelle tournante gaz cyl BSP 60°

Femmina a 90° BSP sede 60°

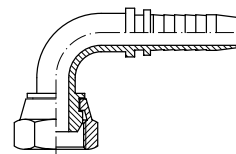

DN	THREAD ROSCA	Part nº Referencia	€
3/16"	1/8" BSP	241070203	2,81
1/4"	1/8" BSP	241070204	2,09
3/16"	1/4" BSP	241070403	2,60
1/4"	1/4" BSP	241070404	2,23
1/4"	3/8" BSP	241070604	3,07
5/16"	3/8" BSP	241070605	3,38
3/8"	3/8" BSP	241070606	2,86
1/4"	1/2" BSP	241070804	4,92
3/8"	1/2" BSP	241070806	3,76
1/2"	1/2" BSP	241070808	3,68
1/2"	5/8" BSP	241071008	7,55
5/8"	5/8" BSP	241071010	6,71
1/2"	3/4" BSP	241071208	7,50
5/8"	3/4" BSP	241071210	7,36
3/4"	3/4" BSP	241071212	7,32
3/4"	1" BSP	241071612	13,19
1"	1" BSP	241071616	13,68

Para aquellas mayores de 1" ver con junta / For those bigger than 1" see with o'ring / Pour ceux plus grand que 1" voir avec o'ring / Per quelli più grandi di 1" vedere con o'ring

## Hembras giratorias rectas BSP cono 60° con junta tórica tuerca libre

BSP Swivel female 60° with o'ring, loose nut

Femelle tournante droite gaz cyl BSP 60° + o'ring, écrou libre

Femmina diritta BSP sede 60° con o'ring, dado libero

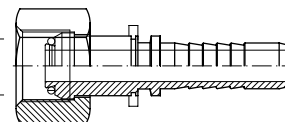

DN	THREAD ROSCA	Part nº Referencia	€
1/4"	1/4" BSP	241100404L	3,25
3/8"	3/8" BSP	241100606L	5,26
1/2"	1/2" BSP	241100808L	5,08

## Hembras giratorias 90° BSP cono 60° con junta tórica tuerca libre

BSP Swivel female 60° with o'ring, loose nut (90° Elbow)

Coude 90° femelle tournante gaz cyl BSP 60° + o'ring, écrou libre

Femmina a 90° BSP sede 60° con o'ring, dado libero

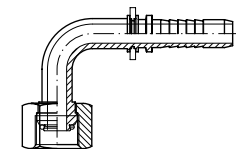

DN	THREAD ROSCA	Part nº Referencia	€
1/4"	1/4" BSP	241170404L	6,77
3/8"	3/8" BSP	241170606L	7,58
1/2"	1/2" BSP	241170808L	10,38

# Conexiones Serie Standard

Standard series fittings  
Emboutis série Standard  
Raccordi serie Standard

Hoses

Flexible hose fittings

Flow measuring

Equipment for flexible hoses

## Hembras giratorias rectas BSP cono 60° con junta tórica

BSP Swivel female 60° with o'ring

Femelle tournante droit gaz cyl BSP 60° + o'ring

Femmina diritta BSP sede 60° con o'ring

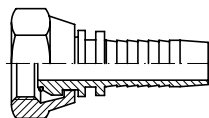

DN	THREAD ROSCA	Part n° Referencia	€
1/4"	1/4" BSP	241100404	1,95
3/8"	3/8" BSP	241100606	2,21
1/2"	1/2" BSP	241100808	3,24
5/8"	5/8" BSP	241101010	5,12
5/8"	3/4" BSP	241101210	4,74
3/4"	3/4" BSP	241101212	4,30
1"	1" BSP	241101616	9,44
1"	1"1/4 BSP	241102016	16,39
1"1/4	1"1/4 BSP	241102020	17,16
1" 1/4	1" 1/2 BSP	241102420	22,52
1"1/2	1"1/2 BSP	241102424	22,30
1"1/2	2" BSP	241103224	40,28
2"	2" BSP	241103232	40,53

## Hembras giratorias 45° BSP cono 60° con junta tórica

BSP Swivel female 60° cone with o'ring (45° Elbow)

Coude 45° femelle tournante gaz cyl BSP 60° + o'ring

Femmina a 45° BSP sede 60° con o'ring

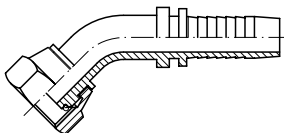

DN	THREAD ROSCA	Part n° Referencia	€
3/8"	3/8" BSP	241180606	3,24
1/2"	1/2" BSP	241180808	4,15
5/8"	5/8" BSP	241181010	8,23
3/4"	3/4" BSP	241181212	13,46
1"	1" BSP	241181616	15,09
1"1/4	1"1/4 BSP	241182020	21,69
1"1/2	1"1/2 BSP	241182424	29,71
1"1/2	2" BSP	241183224 *	95,60
2"	2" BSP	241183232	48,21

\*Hasta fin de existencias. / \*Until end of stock. / \*Jusqu'à la fin du stock. / \*Fino ad esaurimento scorta.

## Hembras giratorias 90° BSP cono 60° con junta tórica

BSP Swivel female 60° cone with o'ring (90° Elbow)

Coude 90° femelle tournante gaz cyl BSP 60° + o'ring

Femmina a 90° BSP sede 60° con o'ring

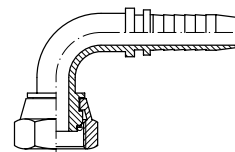

DN	THREAD ROSCA	Part n° Referencia	€
1/4"	1/4" BSP	241170404	3,41
3/8"	3/8" BSP	241170606	4,41
1/2"	1/2" BSP	241170808	6,17
5/8"	5/8" BSP	241171010	8,23
3/4"	3/4" BSP	241171212	9,98
1"	1" BSP	241171616	17,63
1"	1"1/4 BSP	241172016	27,28
1"1/4	1"1/4 BSP	241172020	32,01
1"1/4	1"1/2 BSP	241172420	47,43
1"1/2	1"1/2 BSP	241172424	37,14
2"	2" BSP	241173232	88,38

## Hembras giratorias BSP 60° doble hexagono

BSP Swivel female 60° cone double hex.

Femelle tournante BSP cône 60° double hexagonal

Femmina diritta BSP sede 60° doppio esagono

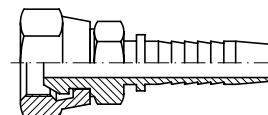

DN	THREAD ROSCA	Part n° Referencia	€
1/4"	1/4" BSP	244000404	2,52
5/16"	3/8" BSP	244000605	2,86
3/8"	3/8" BSP	244000606	3,07
1/2"	1/2" BSP	244000808	3,77
3/4"	3/4" BSP	244001212	7,80
1"	1" BSP	244001616	10,40
1"1/4	1"1/4 BSP	244002020	22,84
1"1/2	1"1/2 BSP	244002424	34,55
2"	2" BSP	244003232	57,85

**NOVEDAD: Disponibles en diámetros 2" 1/2 - 3"**  
**NEW: Larger diameters available 2" 1/2 - 3"**



EN 853 2SN / SAE 100 R2AT  
MS3511...



R1AT/R2AT/1SN/2SN/2SC/R16/3TE  
DI2212...



BSP (60°)  
24100...



BSP (60°)  
A1020... | A1010...

Consulta en nuestra ficha técnica. | Check our technical sheet for data options.

# Conexiones Serie Standard

Standard series fittings  
Emboutis série Standard  
Raccordi serie Standard

## Hembras giratorias rectas BSP asiento plano

*BSP Swivel female flat seat*

Femelle tournante fond plat BSP

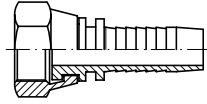

*Femmina diritta BSP sede piana*

DN	THREAD ROSCA	Part n° Referencia	€
1/4"	1/4" BSP	<b>242000404</b>	<b>1,77</b>
5/16"	3/8" BSP	<b>242000605</b>	<b>2,41</b>
3/8"	3/8" BSP	<b>242000606</b>	<b>2,41</b>
3/8"	1/2" BSP	<b>242000806</b>	<b>3,29</b>
1/2"	1/2" BSP	<b>242000808</b>	<b>3,29</b>
1/2"	3/4" BSP	<b>242001208</b>	<b>4,77</b>
3/4"	3/4" BSP	<b>242001212</b>	<b>5,17</b>
1"	1" BSP	<b>242001616</b>	<b>8,38</b>
1" 1/4	1" 1/4 BSP	<b>242002020</b>	<b>18,37</b>
1" 1/2	1" 1/2 BSP	<b>242002424</b>	<b>24,10</b>

## Macho rosca cilíndrica BSP asiento plano

*BSP Male flat seat*

Mâle fixe gaz cyl fond plat

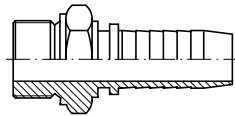

*Maschio BSP cilindrico sede piana*

DN	THREAD ROSCA	Part n° Referencia	€
1/4"	1/4" BSP	<b>242120404</b>	<b>2,53</b>
3/8"	3/8" BSP	<b>242120606</b>	<b>3,32</b>
3/8"	1/2" BSP	<b>242120806</b>	<b>4,65</b>
1/2"	1/2" BSP	<b>242120808</b>	<b>4,45</b>
3/4"	3/4" BSP	<b>242121212</b>	<b>6,77</b>
1"	1" BSP	<b>242121616</b>	<b>12,53</b>

## Hembras giratorias 90° BSP asiento plano

*BSP Swivel female flat seat (90° Elbow)*

Embout à sertir coude 90° femelle tournante fond plat BSP

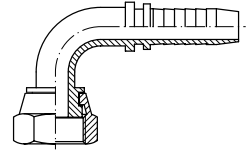

*Femmina a 90° BSP sede 60° sede piana*

DN	THREAD ROSCA	Part n° Referencia	€
1/4"	1/4" BSP	<b>242070404</b>	<b>2,90</b>
3/8"	3/8" BSP	<b>242070606</b>	<b>3,94</b>
1/2"	1/2" BSP	<b>242070808</b>	<b>4,57</b>
3/4"	3/4" BSP	<b>242071212</b>	<b>10,37</b>
1"	1" BSP	<b>242071616</b>	<b>18,56</b>

## Hembras giratorias 90° BSP cono 60° (forja)

*BSP Swivel female 60° cone forge (90° Elbow)*

Coude 90° femelle tournante forge gaz cyl BSP 60°

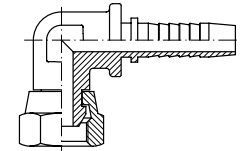

*Femmina a 90° BSP sede 60° (forgiatta)*

DN	THREAD ROSCA	Part n° Referencia	€
1/4"	1/4" BSP	<b>241270404</b>	<b>3,95</b>
5/16"	3/8" BSP	<b>241270605</b>	<b>3,95</b>
3/8"	3/8" BSP	<b>241270606</b>	<b>4,92</b>
5/16"	1/2" BSP	<b>241270806</b>	<b>4,86</b>
1/2"	1/2" BSP	<b>241270808</b>	<b>6,16</b>
5/8"	3/4" BSP	<b>241271210</b>	<b>8,10</b>
3/4"	3/4" BSP	<b>241271212</b>	<b>10,40</b>

# Conexiones Serie Standard

Standard series fittings  
Embouts série Standard  
Raccordi serie Standard

## Macho rosca cilíndrica BSP cono 60°

BSP Male parallel 60° cone

Mâle fixe gaz cyl BSP 60°

Maschio BSP cilindrico sede 60°

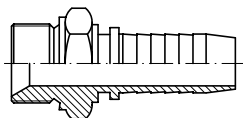

DN	THREAD ROSCA	Part nº Referencia	€
3/16"	1/8" BSP	241120203	1,39
1/4"	1/8" BSP	241120204	1,60
1/8"	1/4" BSP	241120402	5,59
3/16"	1/4" BSP	241120403	3,26
1/4"	1/4" BSP	241120404	1,44
3/8"	1/4" BSP	241120406	2,34
1/4"	3/8" BSP	241120604	2,13
5/16"	3/8" BSP	241120605	2,12
3/8"	3/8" BSP	241120606	1,88
1/2"	3/8" BSP	241120608	2,60
1/4"	1/2" BSP	241120804	2,94
3/8"	1/2" BSP	241120806	2,57
1/2"	1/2" BSP	241120808	2,57
1/2"	5/8" BSP	241121008	5,22
5/8"	5/8" BSP	241121010	4,17
1/2"	3/4" BSP	241121208	5,11
5/8"	3/4" BSP	241121210	5,12
3/4"	3/4" BSP	241121212	4,43
3/4"	1" BSP	241121612	9,94
1"	1" BSP	241121616	7,39
1"	1"1/4 BSP	241122016	19,49
1"1/4"	1"1/4 BSP	241122020	18,93
1"1/2"	1"1/2 BSP	241122424	20,42
2"	2" BSP	241123232	49,32

## Orientable BSP

Banjo BSP

Embout Banjo droit gaz

Raccordo ad occhio BSP

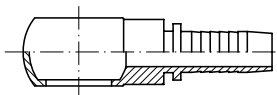

DN	Ø	Part nº Referencia	€
3/16"	1/4" BSP	241110403	2,84
1/4"	1/4" BSP	241110404	2,41
5/16"	1/4" BSP	241110405	2,97
3/8"	1/4" BSP	241110406	2,97
1/4"	3/8" BSP	241110604	3,62
5/16"	3/8" BSP	241110605	3,92
3/8"	3/8" BSP	241110606	3,12
1/2"	3/8" BSP	241110608	3,51
3/8"	1/2" BSP	241110806	5,11
1/2"	1/2" BSP	241110808	5,15
5/8"	5/8" BSP	241111010	10,61
1/2"	3/4" BSP	241111208	11,40
5/8"	3/4" BSP	241111210	12,54
3/4"	3/4" BSP	241111212	12,54
1"	1" BSP	241111616	27,48

## Macho rosca cónica BSPT

BSPT Male tapered

Mâle fixe gaz conique BSPT

Maschio BSPT conico

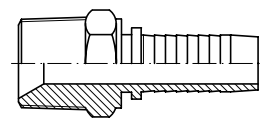

DN	THREAD ROSCA	Part nº Referencia	€
3/16"	1/8" BSPT	241140203	1,25
1/4"	1/8" BSPT	241140204	1,16
1/4"	1/4" BSPT	241140404	1,16
1/4"	3/8" BSPT	241140604	1,86
5/16"	3/8" BSPT	241140605	1,88
3/8"	3/8" BSPT	241140606	1,75
3/8"	1/2" BSP	241140806	2,33
1/2"	1/2" BSPT	241140808	2,42
5/8"	3/4" BSPT	241141210	4,08
3/4"	3/4" BSPT	241141212	4,65
3/4"	1" BSPT	241141612	8,35
1"	1" BSPT	241141616	9,31
1"	1"1/4 BSPT	241142016	15,11
1" 1/4"	1"1/4 BSPT	241142020	17,58
1" 1/2"	1" 1/2 BSPT	241142424	17,25
2"	2" BSPT	241143232	43,03

## Tornillo orientable simple BSP

BSP bolt for Banjo

Vis creuse simple pour banjo filetage gaz BSP

Bullone forato BSP

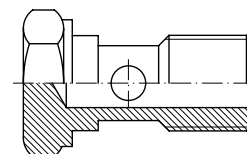

THREAD ROSCA	Part nº Referencia	€
1/8" BSP	A109002	*
1/4" BSP	A109004	*
3/8" BSP	A109006	*
1/2" BSP	A109008	*
5/8" BSP	A109010	*
3/4" BSP	A109012	*
1" BSP	A109016	*
1"1/4 BSP	A109020	*
1"1/2 BSP	A109024	*

\*Ver precios en p.292 (ADAPTADORES BSP) / \*See prices in p.292 (BSP ADAPTORS) / \*Prix à la p.292 (ADAPTEURS BSP) / \*Vedere prezzi p.292 (ADATTATORI BSP)

# Conexiones Serie Standard

Standard series fittings  
Embouts série Standard  
Raccordi serie Standard

## Hembras giratorias rectas JIC 37°

JIC Swivel female 37° cone

Femelle tournante droite JIC cône 37°

Femmina diritta JIC 37°

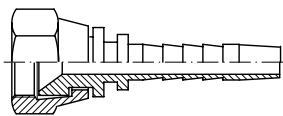

DN	THREAD ROSCA	Part n° Referencia	€
3/16"	7/16" 20h UNF	241420703	1,55
1/4"	7/16" 20h UNF	241420704	1,39
1/4"	1/2" 20h UNF	241420804	1,62
5/16"	1/2" 20h UNF	241420805	2,23
1/4"	9/16" 18h UNF	241420904	1,52
5/16"	9/16" 18h UNF	241420905	1,56
3/8"	9/16" 18h UNF	241420906	1,70
3/8"	5/8" 18h UNF	241421006	2,81
5/16"	3/4" 16h UNF	241421205	2,34
3/8"	3/4" 16h UNF	241421206	2,19
1/2"	3/4" 16h UNF	241421208	2,55
3/8"	7/8" 14h UNF	241421406	2,89
1/2"	7/8" 14h UNF	241421408	2,80
5/8"	7/8" 14h UNF	241421410	3,58
1/2"	1"1/16 12h UNF	241421708	4,76
5/8"	1"1/16 12h UNF	241421710	4,52
3/4"	1"1/16 12h UNF	241421712	4,06
1"	1"1/16 12h UNF	241421716	8,40
3/4"	1"5/16 12h UNF	241422112	9,15
1"	1"5/16 12h UNF	241422116	9,63
1"	1"5/8 12h UNF	241422616	15,01
1"1/4"	1"5/8 12h UNF	241422620	13,05
1"1/4"	1"7/8 12h UNF	241423020	29,33
1"1/2"	1"7/8 12h UNF	241423024	20,66
2"	2"1/2 12h UNF	241424032	37,50

## Hembras giratorias rectas JIC 37° doble hexagono

JIC swivel female 37° cone double hex.

Femelle JIC 37° double hexagonal

Femmina diritta JIC 37° doppio esagono

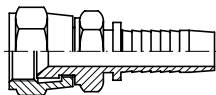

DN	THREAD ROSCA	Part n° Referencia	€
1/4"	7/16" 20h UNF	242420704	2,09
1/4"	1/2" 20h UNF	242420804	2,32
5/16"	9/16" 18h UNF	242420905	2,85
3/8"	9/16" 18h UNF	242420906	2,85
3/8"	3/4" 16h UNF	242421206	3,16
1/2"	3/4" 16h UNF	242421208	3,69
1/2"	7/8" 14h UNF	242421408	4,68
3/4"	1"1/16 12h UN	242421712	6,99
1"	1"5/16 12h UN	242422116	9,70
1"1/4"	1"5/8 12h UN	242422620	20,56
1"1/2"	1"7/8 12h UN	242423024	31,64
2"	2"1/2 12h UN	242424032	58,83

## Hembras giratorias 90° JIC 37°

JIC Swivel female 37° cone (90° Elbow)

Coûde 90° femelle tournante cône JIC 37°

Femmina a 90° JIC 37°

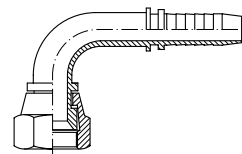

DN	THREAD ROSCA	Part n° Referencia	€
3/16"	7/16" 20h UNF	241380703	3,96
1/4"	7/16" 20h UNF	241380704	2,21
1/4"	1/2" 20h UNF	241380804	3,42
1/4"	9/16" 18h UNF	241380904	2,60
5/16"	9/16" 18h UNF	241380905	3,34
3/8"	9/16" 18h UNF	241380906	2,86
3/8"	5/8" 18h UNF	241381006	4,56
3/8"	3/4" 16h UNF	241381206	3,66
1/2"	3/4" 16h UNF	241381208	4,05
3/8"	7/8" 14h UNF	241381406	6,72
1/2"	7/8" 14h UNF	241381408	4,50
5/8"	7/8" 14h UNF	241381410	7,74
1/2"	1"1/16 12h UNF	241381708	10,95
5/8"	1"1/16 12h UNF	241381710	9,46
3/4"	1"1/16 12h UNF	241381712	8,83
3/4"	1"5/16 12h UNF	241382112	16,31
1"	1"5/16 12h UNF	241382116	13,89
1"	1"5/8 12h UNF	241382616	28,80
1"1/4"	1"5/8 12h UNF	241382620	27,84
1"1/4"	1"7/8 12h UNF	241383020	44,78
1"1/2"	1"7/8 12h UNF	241383024	40,28
2"	2"1/2 12h UNF	241384032	85,61

## Hembras giratorias 45° JIC 37°

JIC swivel female 37° cone (45° Elbow)

Coûde 45° femelle tournante cône JIC 37°

Femmina a 45° JIC 37°

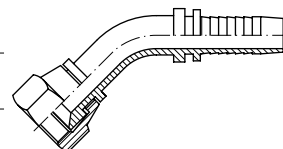

DN	THREAD ROSCA	Part n° Referencia	€
1/4"	7/16" 20h UNF	241390704	2,78
1/4"	1/2" 20h UNF	241390804	3,34
1/4"	9/16" 18h UNF	241390904	3,38
5/16"	9/16" 18h UNF	241390905	3,12
3/8"	9/16" 18h UNF	241390906	3,58
3/8"	3/4" 16h UNF	241391206	4,97
1/2"	3/4" 16h UNF	241391208	5,08
1/2"	7/8" 14h UNF	241391408	6,36
5/8"	7/8" 14h UNF	241391410	6,56
1/2"	1"1/16 12h UNF	241391708	10,59
5/8"	1"1/16 12h UNF	241391710	9,87
3/4"	1"1/16 12h UNF	241391712	8,55
3/4"	1"5/16 12h UNF	241392112	17,40
1"	1"5/16 12h UNF	241392116	15,11
1"	1"5/8 12h UNF	241392616	28,80
1"1/4"	1"5/8 12h UNF	241392620	32,46
1"1/4"	1"7/8 12h UNF	241393020	48,68
1"1/2"	1"7/8 12h UNF	241393024	48,68
2"	2"1/2 12h UNF	241394032	85,61

# Conexiones Serie Standard

Standard series fittings  
Embouts série Standard  
Raccordi serie Standard

## Macho JIC 37°

Male JIC 37° cone

Mâle fixe JIC cône 37°

Maschio JIC 37°

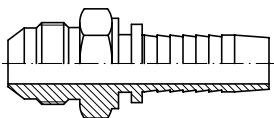

DN	THREAD ROSCA	Part n° Referencia	€
1/4"	7/16" 20h UNF	<b>241400704</b>	<b>1,29</b>
1/4"	1/2" 20h UNF	<b>241400804</b>	<b>2,32</b>
5/16"	1/2" 20h UNF	<b>241400805</b>	<b>2,15</b>
1/4"	9/16" 18h UNF	<b>241400904</b>	<b>1,59</b>
5/16"	9/16" 18h UNF	<b>241400905</b>	<b>1,83</b>
3/8"	9/16" 18h UNF	<b>241400906</b>	<b>1,48</b>
3/8"	3/4" 16h UNF	<b>241401206</b>	<b>2,16</b>
1/2"	3/4" 16h UNF	<b>241401208</b>	<b>1,96</b>
3/8"	7/8" 14h UNF	<b>241401406</b>	<b>3,08</b>
1/2"	7/8" 14h UNF	<b>241401408</b>	<b>2,69</b>
5/8"	7/8" 14h UNF	<b>241401410</b>	<b>3,18</b>
1/2"	1"1/16 12h UNF	<b>241401708</b>	<b>4,76</b>
5/8"	1"1/16 12h UNF	<b>241401710</b>	<b>4,31</b>
3/4"	1"1/16 12h UNF	<b>241401712</b>	<b>5,57</b>
3/4"	1"5/16 12h UNF	<b>241402112</b>	<b>7,97</b>
1"	1"5/16 12h UNF	<b>241402116</b>	<b>10,04</b>
1"	1"5/8 12h UNF	<b>241402616</b>	<b>16,30</b>
1"1/4	1"5/8 12h UNF	<b>241402620</b>	<b>17,84</b>
1"1/4	1"7/8 12h UNF	<b>241403020</b>	<b>25,17</b>
1"1/2	1"7/8 12h UNF	<b>241403024</b>	<b>25,17</b>
2"	2"1/2 12h UNF	<b>241404032</b>	<b>46,62</b>

## Espigas de prensar dobles

Double hose tail for crimping

Embout double jonction

Giunzione tubo-tubo

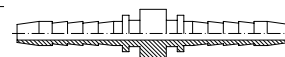

DN	Part n° Referencia	€
1/4"	<b>243000404</b>	<b>1,29</b>
5/16"	<b>243000505</b>	<b>1,95</b>
3/8"	<b>243000606</b>	<b>2,03</b>
1/2"	<b>243000808</b>	<b>2,37</b>
3/4"	<b>243001212</b>	<b>8,37</b>
1"	<b>243001616</b>	<b>13,51</b>

## Machos Stecko

Stecko male connections

Mâle fixe Stecko

Maschio Stecko

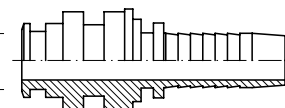

DN	STECKO	Part n° Referencia	€
1/4"	1/4"	<b>241900404</b>	<b>2,56</b>
3/8"	3/8"	<b>241900606</b>	<b>4,04</b>
1/2"	1/2"	<b>241900808</b>	<b>7,78</b>
3/4"	3/4"	<b>241901212</b>	<b>8,24</b>

# Conexiones Serie Standard

Standard series fittings  
Embouts série Standard  
Raccordi serie Standard

## Hembras giratorias Métricas cono 24° con junta tórica

Metric swivel female 24° cone with o'ring

Femelle tournante droite Métrique cône 24°  
+ o'ring

Femmina Metrica sede 24° con o'ring

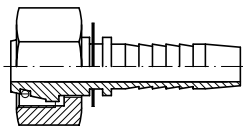

DN	PIPE TUBO	SERIE	THREAD ROSCA	Part nº Referencia	€
3/16"	6	L	12X1,5	24804120603	1,77
1/4"	6	L	12X1,5	24804120604	1,52
1/4"	8	L	14X1,5	24804140804	1,41
5/16"	8	L	14x1.5	24804140805	1,76
3/8"	8	L	14x1.5	24804140806	1,98
1/4"	10	L	16X1,5	24804161004	1,70
5/16"	10	L	16X1,5	24804161005	1,78
3/8"	10	L	16X1,5	24804161006	2,25
1/4"	12	L	18X1,5	24804181204	2,03
5/16"	12	L	18X1,5	24804181205	1,93
3/8"	12	L	18X1,5	24804181206	1,83
1/2"	12	L	18x1.5	24804181208	2,61
1/4"	15	L	22x1.5	24804221504	3,09
5/16"	15	L	22x1.5	24804221505	3,09
3/8"	15	L	22X1,5	24804221506	3,06
1/2"	15	L	22X1,5	24804221508	2,60
3/8"	18	L	26x1.5	24804261806	4,14
1/2"	18	L	26X1,5	24804261808	4,50
5/8"	18	L	26X1,5	24804261810	3,27
3/4"	18	L	26x1.5	24804261812	4,23
1/2"	22	L	30x2	24804302208	5,22
5/8"	22	L	30x2	24804302210	7,67
3/4"	22	L	30X2	24804302212	5,02
3/4"	28	L	36x2	24804362812	7,01
1"	28	L	36X2	24804362816	9,82
1"	35	L	45x2	24804453516	12,16
1"1/4	35	L	45X2	24804453520	15,11
1" 1/4	42	L	42x2	24804524220	18,95
1"1/2	42	L	52X2	24804524224	20,84
2"	42	L	52x2	24804524232	22,46
1/4"	6	S	14x1.5	24804140604	1,69
3/16"	8	S	16X1,5	24804160803	2,28
1/4"	8	S	16X1,5	24804160804	1,82
5/16"	8	S	16x1.5	24804160805	1,98
3/8"	8	S	16x1.5	24804160806	2,13
1/4"	10	S	18X1,5	24804181004	2,27
5/16"	10	S	18x1.5	24804181005	2,12
3/8"	10	S	18x1,5	24804181006	2,57
1/4"	12	S	20x1,5	24804201204	2,57
5/16"	12	S	20X1,5	24804201205	1,93
3/8"	12	S	20X1,5	24804201206	2,01
1/2"	12	S	20X1,5	24804201208	4,87
5/16"	14	S	22x1.5	24804221405	3,07
3/8"	14	S	22X1,5	24804221406	2,89
1/2"	14	S	22x1,5	24804221408	2,81
1/4"	16	S	24x1.5	24804241604	3,07
5/16"	16	S	24x1.5	24804241605	3,67
3/8"	16	S	24x1.5	24804241606	3,25
1/2"	16	S	24X1,5	24804241608	3,22
5/8"	16	S	24x1.5	24804241610	3,35
3/8"	20	S	30x2	24804302006	5,25
1/2"	20	S	30x2	24804302008	4,34
5/8"	20	S	30X2	24804302010	4,14
3/4"	20	S	30X2	24804302012	5,80
1/2"	25	S	36x2	24804362508	9,54
5/8"	25	S	36x2	24804362510	7,57
3/4"	25	S	36X2	24804362512	9,23
1"	25	S	36X2	24804362516	11,45
5/8"	30	S	42x2	24804423010	8,67
3/4"	30	S	42x2	24804423012	8,86
1"	30	S	42X2	24804423016	13,51
1"1/4	38	S	52X2	24804523820	19,57

## Hembras giratorias 90° Métricas cono 24° con junta tórica

Metric swivel female 24° cone with o'ring (90° Elbow)

Coude 90° femelle tournante Métrique cône 24°  
+ o'ring

Femmina Metrica a 90° sede 24° con o'ring

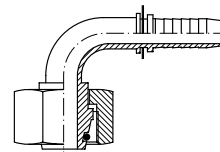

DN	PIPE TUBO	SERIE	THREAD ROSCA	Part nº Referencia	€
3/16"	6	L	12x1,5	24305120603	2,25
1/4"	6	L	12x1,5	24305120604	2,57
1/4"	8	L	14x1,5	24305140804	2,61
5/16"	8	L	14x1.5	24305140805	3,13
1/4"	10	L	16x1,5	24305161004	2,80
5/16"	10	L	16x1,5	24305161005	2,83
3/8"	10	L	16x1,5	24305161006	3,05
1/4"	12	L	18x1,5	24305181204	5,34
5/16"	12	L	18x1,5	24305181205	3,48
3/8"	12	L	18x1,5	24305181206	2,85
1/2"	12	L	18x1.5	24305181208	4,35
3/8"	15	L	22x1.5	24305221506	5,06
1/2"	15	L	22x1.5	24305221508	4,25
1/2"	18	L	26x1.5	24305261808	6,52
5/8"	18	L	26x1,5	24305261810	7,10
5/8"	22	L	30x2	24305302210	11,62
3/4"	22	L	30x2	24305302212	10,74
3/4"	28	L	36x2	24305362812	9,89
1"	28	L	36x2	24305362816	16,70
1"1/4	35	L	45x2	24305453520	27,04
1"1/2	42	L	52x2	24305524224	48,02
3/16"	6	S	14x1.5	24305140603	2,89
1/4"	8	S	16x1,5	24305160804	2,72
5/16"	8	S	16x1,5	24305160805	3,13
1/4"	10	S	18x1,5	24305181004	2,78
5/16"	10	S	18x1,5	24305181005	3,77
3/8"	10	S	18x1,5	24305181006	4,79
1/4"	12	S	20x1,5	24305201204	4,98
5/16"	12	S	20x1,5	24305201205	4,31
3/8"	12	S	20x1,5	24305201206	2,83
1/2"	12	S	20x1.5	24305201208	4,01
3/8"	14	S	22x1,5	24305221406	5,34
3/8"	16	S	24x1,5	24305241606	4,10
1/2"	16	S	24x1,5	24305241608	4,68
5/8"	20	S	30x2	24305302010	8,18
3/4"	20	S	30x2	24305302012	10,74
3/4"	25	S	36x2	24305362512	13,92
1"	25	S	36x2	24305362516	18,74
5/8"	30	S	42x2	24305423010	10,30
3/4"	30	S	42x2	24305423012	10,81
1"	30	S	42x2	24305423016	23,66
1"1/4	38	S	52x2	24305523820	37,98

# Conexiones Serie Standard

Standard series fittings  
Embouts série Standard  
Raccordi serie Standard

## Hembras giratorias 45° Métricas cono 24° con junta tórica

Metric swivel female 24° cone with o'ring (45° Elbow)

Coûde 45° femelle tournante Métrique cône 24°+ o'ring

Femmina Metrica a 45° sede 24° con o'ring

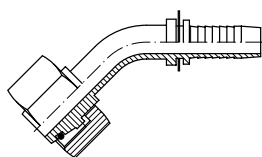

DN	PIPE TUBO	SERIE	THREAD ROSCA	Part nº Referencia	€
3/16"	6	L	12x1,5	<b>24306120603</b>	<b>3,10</b>
1/4"	6	L	12x1,5	<b>24306120604</b>	<b>2,69</b>
1/4"	8	L	14x1,5	<b>24306140804</b>	<b>2,68</b>
5/16"	8	L	14x1,5	<b>24306140805</b>	<b>3,26</b>
1/4"	10	L	16x1,5	<b>24306161004</b>	<b>2,94</b>
5/16"	10	L	16x1,5	<b>24306161005</b>	<b>2,84</b>
3/8"	10	L	16x1,5	<b>24306161006</b>	<b>3,27</b>
1/4"	12	L	18x1,5	<b>24306181204</b>	<b>3,66</b>
5/16"	12	L	18x1,5	<b>24306181205</b>	<b>4,00</b>
3/8"	12	L	18x1,5	<b>24306181206</b>	<b>2,75</b>
1/2"	12	L	18x1,5	<b>24306181208</b>	<b>4,54</b>
3/8"	15	L	22x1,5	<b>24306221506</b>	<b>6,52</b>
1/2"	15	L	22x1,5	<b>24306221508</b>	<b>4,93</b>
1/2"	18	L	26x1,5	<b>24306261808</b>	<b>6,81</b>
5/8"	18	L	26x1,5	<b>24306261810</b>	<b>7,26</b>
5/8"	22	L	30x2	<b>24306302210</b>	<b>8,07</b>
3/4"	22	L	30x2	<b>24306302212</b>	<b>10,49</b>
3/4"	28	L	36x2	<b>24306362812</b>	<b>10,32</b>
1"	28	L	36x2	<b>24306362816</b>	<b>16,76</b>
1 1/4"	35	L	45x2	<b>24306453520</b>	<b>29,16</b>
1 1/2"	42	L	52x2	<b>24306524224</b>	<b>46,48</b>
3/16"	6	S	14x1,5	<b>24306140603</b>	<b>3,78</b>
1/4"	6	S	14x1,5	<b>24306140604</b>	<b>3,22</b>
1/4"	8	S	16x1,5	<b>24306160804</b>	<b>3,47</b>
5/16"	8	S	16x1,5	<b>24306160805</b>	<b>3,26</b>
1/4"	10	S	18x1,5	<b>24306181004</b>	<b>4,12</b>
5/16"	10	S	18x1,5	<b>24306181005</b>	<b>3,43</b>
3/8"	10	S	18x1,5	<b>24306181006</b>	<b>3,43</b>
1/4"	12	S	20x1,5	<b>24306201204</b>	<b>3,98</b>
5/16"	12	S	20x1,5	<b>24306201205</b>	<b>4,66</b>
3/8"	12	S	20x1,5	<b>24306201206</b>	<b>4,47</b>
1/2"	12	S	20x1,5	<b>24306201208</b>	<b>4,48</b>
3/8"	14	S	22x1,5	<b>24306221406</b>	<b>5,34</b>
3/8"	16	S	24x1,5	<b>24306241606</b>	<b>4,70</b>
1/2"	16	S	24x1,5	<b>24306241608</b>	<b>5,24</b>
5/8"	20	S	30x2	<b>24306302010</b>	<b>9,22</b>
3/4"	20	S	30x2	<b>24306302012</b>	<b>11,27</b>
3/4"	25	S	36x2	<b>24306362512</b>	<b>15,68</b>
1"	25	S	36x2	<b>24306362516</b>	<b>16,76</b>
3/4"	30	S	42x2	<b>24306423012</b>	<b>11,29</b>
1"	30	S	42x2	<b>24306423016</b>	<b>21,89</b>
1 1/4"	38	S	52x2	<b>24306523820</b>	<b>41,08</b>

## Machos fijos Métricos cono 24°

Male stud Metric thread 24° cone

Mâle fixe Métrique cône 24°

Maschio Metrico sede 24°

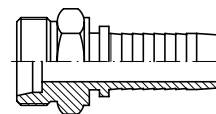

DN	PIPE TUBO	SERIE	THREAD ROSCA	Part nº Referencia	€
3/16"	6	L	12x1,5	<b>24203120603</b>	<b>1,36</b>
1/4"	6	L	12x1,5	<b>24203120604</b>	<b>1,53</b>
1/4"	8	L	14x1,5	<b>24203140804</b>	<b>1,56</b>
1/4"	10	L	16x1,5	<b>24203161004</b>	<b>1,85</b>
5/16"	10	L	16x1,5	<b>24203161005</b>	<b>1,79</b>
3/8"	10	L	16x1,5	<b>24203161006</b>	<b>1,65</b>
1/4"	12	L	18x1,5	<b>24203181204</b>	<b>1,85</b>
5/16"	12	L	18x1,5	<b>24203181205</b>	<b>2,09</b>
3/8"	12	L	18x1,5	<b>24203181206</b>	<b>1,57</b>
3/8"	15	L	22x1,5	<b>24203221506</b>	<b>2,60</b>
1/2"	15	L	22x1,5	<b>24203221508</b>	<b>2,41</b>
1/2"	18	L	26x1,5	<b>24203261808</b>	<b>3,44</b>
5/8"	18	L	26x1,5	<b>24203261810</b>	<b>2,99</b>
3/4"	22	L	30x2	<b>24203302212</b>	<b>4,71</b>
1"	28	L	36x2	<b>24203362816</b>	<b>9,75</b>
1 1/4"	35	L	45x2	<b>24203453520</b>	<b>14,04</b>
1 1/2"	42	L	52x2	<b>24203524224</b>	<b>22,41</b>
1/4"	8	S	16x1,5	<b>24203160804</b>	<b>1,83</b>
1/4"	10	S	18x1,5	<b>24203181004</b>	<b>2,40</b>
5/16"	10	S	18x1,5	<b>24203181005</b>	<b>2,17</b>
3/8"	10	S	18x1,5	<b>24203181006</b>	<b>2,25</b>
5/16"	12	S	20x1,5	<b>24203201205</b>	<b>2,23</b>
3/8"	12	S	20x1,5	<b>24203201206</b>	<b>2,33</b>
3/8"	14	S	22x1,5	<b>24203221406</b>	<b>2,74</b>
1/2"	16	S	24x1,5	<b>24203241608</b>	<b>3,10</b>
5/8"	20	S	30x2	<b>24203302010</b>	<b>4,65</b>
3/4"	20	S	30x2	<b>24203302012</b>	<b>5,49</b>
3/4"	25	S	36x2	<b>24203362512</b>	<b>9,75</b>
1"	25	S	36x2	<b>24203362516</b>	<b>9,94</b>
1"	30	S	42x2	<b>24203423016</b>	<b>14,02</b>
1 1/4"	38	S	52x2	<b>24203523820</b>	<b>22,26</b>

Ampliamos nuestra gama de **conexiones métricas**

We extend our range of **metric fittings**

# Conexiones Serie Standard

Standard series fittings  
Embouts série Standard  
Raccordi serie Standard

## Orientable Métrico Recto

Banjo metric

Banjo droit Métrique

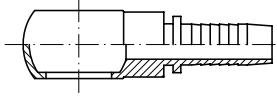

Raccordo ad occhio Metrico

DN	Ø	Part nº Referencia	€
3/16"	M10x1	241161003	2,39
1/4"	M10x1	241161004	2,39
5/16"	M10x1	241161005	2,41
1/8"	M12x1	241161202 *	9,50
3/16"	M12x1.5	241161203	2,46
1/4"	M12x1.5	241161204	2,70
1/4"	M14x1.5	241161404	2,70
5/16"	M14x1.5	241161405	2,99
3/8"	M14x1.5	241161406	3,29
5/16"	M16x1.5	241161605	3,33
3/8"	M16x1.5	241161606	3,20
3/8"	M18x1.5	241161806	4,30
1/2"	M18x1.5	241161808	4,30
1/2"	M22x1.5	241162208	6,60
5/8"	M22x1.5	241162210	4,91
3/4"	M30x2	241163012	10,92

\*Hasta fin de existencias. / \*Until end of stock. / \*Jusqu'à la fin du stock. / \*Fino ad esaurimento scorta.

## Tornillo orientable simple rosca Métrica

Metric bolt for Banjo

Vis creuse simple pour banjo filetage métrique

Bullone forato Metrico

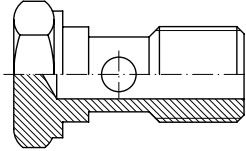

THREAD ROSCA	Part nº Referencia	€
M8x1	S109208	*
M10x1	S109210	*
M12x1.5	S109212	*
M14x1.5	S109214	*
M16x1.5	S109216	*
M18x1.5	S109218	*
M22x1.5	S109222	*
M26x1.5	S109226	*
M30x1.5	S109230	*

\*Ver precios en p.292 (ADAPTADORES BSP) / \*See prices in p.292 (BSP ADAPTORS) / \*Prix à la p.292 (ADAPTEURS BSP) / \*Vedere prezzi p.292 (ADATTATORI BSP)

## Espiga lisa recta Métrica

Metric standpipe

Embout lisse droit Métrique

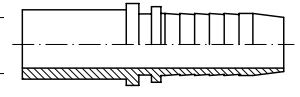

Estremità tubolare diritta Metrica

DN	PIPE TUBO	Part nº Referencia	€
1/8"	6	241580602 L	2,29
3/16"	6	241580603 L	0,95
1/4"	6	241580604 L	0,91
3/16"	8	241580803 L	1,20
1/4"	8	241580804 L	0,94
5/16"	8	241580805 L	3,71
5/16"	10	241581005 L	1,66
3/8"	10	241581006 L	1,26
3/8"	12	241581206 L	1,17
1/2"	12	241581208 L	4,72
3/8"	15	241581506 L	1,77
1/2"	15	241581508 L	1,90
1/2"	18	241581808 L	2,02
5/8"	18	241581810 L	3,49
3/4"	22	241582212 L	4,62
1"	28	241582816 L	8,17
1 1/4"	35	241583520 L	13,46
1 1/2"	42	241584224 L	17,41
1/4"	10	241581004 S	1,03
1/4"	12	241581204 S	1,76
5/16"	12	241581205 S	1,65
3/8"	14	241581406 S	2,18
1/2"	14	241581408 S	2,75
1/2"	16	241581608 S	2,53
3/4"	20	241582012 S	4,62
1"	25	241582516 S	8,65
1"	30	241583016 S	8,29

# Conexiones Serie Standard

Standard series fittings  
Embouts série Standard  
Raccordi serie Standard

Hoses

Flexible hose fittings

Flow measuring

Equipment for flexible hoses

## Hembras giratorias Métricas cono 24°/60°

Female metric swivel 24°/60° cone

Femelle tournante Métrique cône 24°-60°

Femmina Metrica Girevole Multiseal 24°/60°

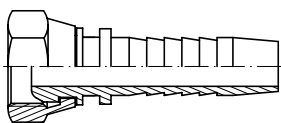

DN	PIPE TUBO	THREAD ROSCA	Part nº Referencia	€
1/4"	8L	M14X1.5	244049511	1,65
1/4"	10L	M16X1.5	244049520	1,99
5/16"	10L	M16X1.5	244049523	1,94
3/8"	10L	M16X1.5	244049524	2,43
5/16"	12L	M18X1.5	244049525	2,17
3/8"	12L	M18X1.5	244049535	2,29
3/8"	15L	M22X1.5	244049552	3,44
1/2"	15L	M22X1.5	244049555	3,85
5/8"	18L	M26X1.5	244049571	4,72

## Hembras giratorias 90° Métricas cono 24°/60°

Female metric swivel 24°/60° cone (90° Elbow)

Femelle tournante coude 90° Métrique cône 24°-60°

Femmina Metrica Girevole a 90° Multiseal 24°/60°

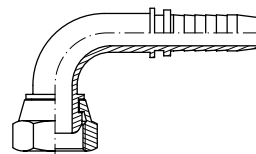

DN	PIPE TUBO	THREAD ROSCA	Part nº Referencia	€
1/4"	8L	M14X1.5	244059511	2,09
1/4"	10L	M16X1.5	244059520	2,41
5/16"	10L	M16X1.5	244059523	2,30
3/8"	10L	M16X1.5	244059524	3,07
5/16"	12L	M18X1.5	244059525	2,67
3/8"	12L	M18X1.5	244059535	2,67
3/8"	15L	M22X1.5	244059552	4,12
1/2"	15L	M22X1.5	244059555	4,83
5/8"	18L	M26X1.5	244059571	6,83

## Hembras giratorias 45° Métricas cono 24°/60°

Female metric swivel 24°/60° cone (45° Elbow)

Femelle tournante coude 45° Métrique cône 24°-60°

Femmina Metrica Girevole a 45° Multiseal 24°/60°

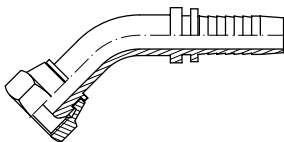

DN	PIPE TUBO	THREAD ROSCA	Part nº Referencia	€
1/4"	8L	M14X1.5	244069511	3,29
5/16"	10L	M16X1.5	244069523	3,50
3/8"	10L	M16X1.5	244069524	4,12
5/16"	12L	M18X1.5	244069525	4,12
3/8"	12L	M18X1.5	244069535	2,81
1/2"	15L	M22X1.5	244069555	5,90
5/8"	18L	M26X1.5	244069571	8,77

## Hembras giratorias rectas Komatsu cono 60°

Komatsu swivel female 60° cone

Femelle tournante droite Komatsu Métrique (cône 60°)

Femmina Komatsu sede 60°

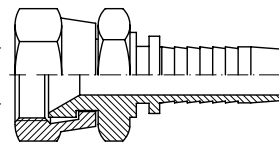

DN	THREAD ROSCA	Part nº Referencia	€
1/4"	M14X1.5	258049625	4,06
3/8"	M18X1.5	258049635	3,67
1/2"	M22X1.5	258049655	6,85
5/8"	M24X1.5	258049665	9,42
3/4"	M30X1.5	258049684	12,81
1"	M33X1.5	258049685	13,68

## ROSCA MÉTRICA - ESTANQUEIDAD CONO METAL-METAL



METRIC THREAD - METAL-METAL CONE SEAL

# Conexiones Serie Standard

Standard series fittings  
Embouts série Standard  
Raccordi serie Standard

## Macho rosca cónica NPT

NPT male thread

Mâle fixe gaz conique NPT

Maschio NPT 60

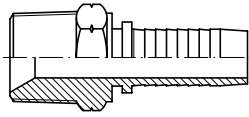

DN	THREAD ROSCA	Part nº Referencia	€
3/16"	1/8" NPT	241610203	1,66
1/4"	1/8" NPT	241610204	1,63
3/16"	1/4" NPT	241610403	1,63
1/4"	1/4" NPT	241610404	1,63
5/16"	1/4" NPT	241610405	2,47
3/8"	1/4" NPT	241610406	2,47
1/4"	3/8" NPT	241610604	2,47
5/16"	3/8" NPT	241610605	2,47
3/8"	3/8" NPT	241610606	2,16
1/2"	3/8" NPT	241610608	3,00
3/8"	1/2" NPT	241610806	3,00
1/2"	1/2" NPT	241610808	2,57
5/8"	1/2" NPT	241610810	4,28
1/2"	3/4" NPT	241611208	5,57
5/8"	3/4" NPT	241611210	4,41
3/4"	3/4" NPT	241611212	4,42
1"	3/4" NPT	241611216	8,20
3/4"	1" NPT	241611612	8,20
1"	1" NPT	241611616	8,20
1"	1 1/4" NPT	241612016	16,58
1 1/4"	1 1/4" NPT	241612020	15,33
1 1/4"	1 1/2" NPT	241612420	22,04
1 1/2"	1 1/2" NPT	241612424	22,04

## Hembras giratorias NPSM

NPSM swivel female

Femelle tournante NPSM

Femmina diritta NPSM

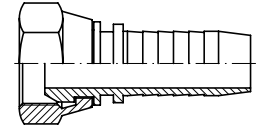

DN	THREAD ROSCA	Part nº Referencia	€
1/4"	1/4" NPSM	242610404	2,13
3/8"	3/8" NPSM	242610606	2,51
1/2"	1/2" NPSM	242610808	3,25
3/4"	3/4" NPSM	242611212	5,10
1"	1" NPSM	242611616	8,54

## Macho Métrico cono 24° serie francesa

Metric stud 24° cone French Series

Mâle fixe Série Française Métrique 24°

Maschio Metrico sede 24°

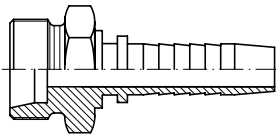

DN	PIPE TUBO	THREAD ROSCA	Part nº Referencia	€
1/4"	13.2	M20X1.5	245032013204	2,20
5/16"	13.2	M20X1.5	245032013205	2,08
3/8"	13.2	M20X1.5	245032013206	2,02
5/16"	16.7	M24X1.5	245032416705	3,30
3/8"	16.7	M24X1.5	245032416706	3,30
1/2"	16.7	M24X1.5	245032416708	3,42
5/8"	21.2	M30X1.5	245033021210	5,81
3/4"	21.2	M30X1.5	245033021212	5,50
3/4"	26.7	M36X1.5	245033626712	8,80
1"	33.5	M45X1.5	245034533516	14,31

## Macho Métrico válvula agrícola

Metric stud for agricultural valve

Mâle fixe Métrique pour valve agricole

Maschio Metrico per valvola agricola

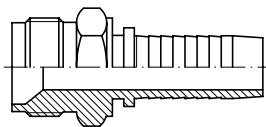

DN	THREAD ROSCA	Part nº Referencia	€
1/4"	M18X1.5	245051804	2,97
5/16"	M18X1.5	245051805	2,78
3/8"	M18X1.5	245051806	2,78

## Hembra giratoria recta Métrica cono 24° serie francesa

Metric swivel female 24° cone French Series

Femelle tournante Série Française Métrique 24°

Femmina Metrica sede 24°

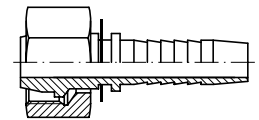

DN	PIPE TUBO	THREAD ROSCA	Part nº Referencia	€
1/4"	13.2	M20X1.5	245042013204	2,45
5/16"	13.2	M20X1.5	245042013205	2,65
3/8"	13.2	M20X1.5	245042013206	2,60
5/16"	16.7	M24X1.5	245042416705	3,71
3/8"	16.7	M24X1.5	245042416706	4,18
1/2"	16.7	M24X1.5	245042416708	4,18
5/8"	21.2	M30X1.5	245043021210	6,17
3/4"	26.7	M36X1.5	245043626712	9,53
1"	33.5	M45X1.5	245044533516	15,86

## Hembra giratoria 90° Métrica cono 24° serie francesa

Metric swivel female 24° cone French Series (90° Elbow)

Femelle tournante coude 90° Série Française Métrique 24°

Femmina Metrica a 90° sede 24°

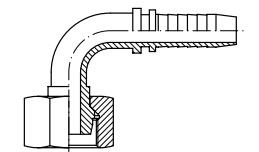

DN	PIPE TUBO	THREAD ROSCA	Part nº Referencia	€
5/16"	13.2	M20X1.5	245052013205	4,72
3/8"	13.2	M20X1.5	245052013206	5,22
1/2"	16.7	M24X1.5	245052416708	6,87
5/8"	21.2	M30X1.5	245053021210	12,86
3/4"	26.7	M36X1.5	245053626712	19,58

# Conexiones Serie Standard

Standard series fittings  
Embouts série Standard  
Raccordi serie Standard

Hoses

Flexible hose fittings

Flow measuring

Equipment for flexible hoses

## Hembra giratoria recta ORFS asiento plano

ORFS Swivel female straight flat seat

Femelle tournante -ORFS fond plat

Femmina diritta sede piana ORFS

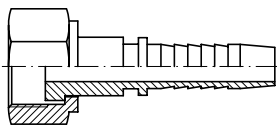

DN	THREAD ROSCA	Part nº Referencia	€
1/4"	9/16" 18h UNF	449000404	2,50
1/4"	11/16" 16h UNF	449000604	3,01
5/16"	11/16" 16h UNF	449000605	3,01
3/8"	11/16" 16h UNF	449000606	2,85
3/8"	13/16" 16h UNF	449000806	3,65
1/2"	13/16" 16h UNF	449000808	2,81
1/2"	1" 14h UNF	449001008	5,06
5/8"	1" 14h UNF	449001010	5,84
1/2"	1" 3/16 12h UNF	449001208	7,56
3/4"	1" 3/16 12h UNF	449001212	7,15
3/4"	1" 7/16 12h UNF	449001612	12,47
1"	1" 7/16 12h UNF	449001616	8,36
1"1/4	1" 11/16 12h UNF	449002020	20,49
1"1/2	2" 12h UNF	449002424	35,11

## Hembra giratoria 90° ORFS asiento plano

ORFS Swivel female flat seat (90° Elbow)

Femelle tournante coude 90° -ORFS fond plat

Femmina a 90° sede piana ORFS

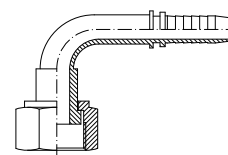

DN	THREAD ROSCA	Part nº Referencia	€
1/4"	9/16" 18h UNF	449070404	3,48
1/4"	11/16" 16h UNF	449070604	4,53
5/16"	11/16" 16h UNF	449070605	4,53
3/8"	11/16" 16h UNF	449070606	4,05
3/8"	13/16" 16h UNF	449070806	6,10
1/2"	13/16" 16h UNF	449070808	5,63
1/2"	1" 14h UNF	449071008	9,30
5/8"	1" 14h UNF	449071010	9,36
1/2"	1" 3/16-12h UNF	449071208	12,81
3/4"	1" 3/16 12h UNF	449071212	11,53
3/4"	1" 7/16 12h UNF	449071612	20,17
1"	1" 7/16 12h UNF	449071616	20,17
1"1/4	1" 11/16 12h UNF	449072020	36,55
1"1/2	2" 12h UNF	449072424	51,09

## Machos ORFS asiento plano con junta tórica

ORFS Male flat seat + o´ring

Mâle fixe -ORFS fond plat + o´ring

Maschio ORFS sede piana con o´ring

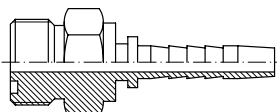

DN	THREAD ROSCA	Part nº Referencia	€
1/4"	9/16" 18h UNF	449120404	2,10
1/4"	11/16" 16h UNF	449120604	2,67
5/16"	11/16" 16h UNF	449120605	2,67
3/8"	11/16" 16h UNF	449120606	2,98
3/8"	13/16" 16h UNF	449120806	3,97
1/2"	13/16" 16h UNF	449120808	3,97
1/2"	1" 14h UNF	449121008	4,87
5/8"	1" 14h UNF	449121010	5,15
1/2"	1" 3/16 12h UNF	449121208	8,38
3/4"	1" 3/16 12h UNF	449121212	8,38
3/4"	1" 7/16 12h UNF	449121612	13,86
1"	1" 7/16 12h UNF	449121616	13,86
1"1/4	1" 11/16-12h UNF	449122020	23,36

## Hembra giratoria 45° ORFS asiento plano

ORFS Swivel female (45° Elbow) flat seat

Femelle tournante coude 45° -ORFS fond plat

Femmina a 45° sede piana ORFS

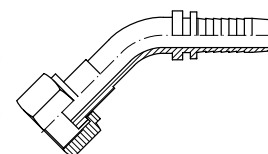

DN	THREAD ROSCA	Part nº Referencia	€
1/4"	9/16" 18h UNF	449080404	2,67
1/4"	11/16" 16h UNF	449080604	4,53
5/16"	11/16" 16h UNF	449080605	4,53
3/8"	11/16" 16h UNF	449080606	4,21
3/8"	13/16" 16h UNF	449080806	6,15
1/2"	13/16" 16h UNF	449080808	6,29
1/2"	1" 14h UNF	449081008	8,94
5/8"	1" 14h UNF	449081010	9,31
1/2"	1" 3/16 12h UNF	449081208	12,81
3/4"	1" 3/16 12h UNF	449081212	13,95
3/4"	1" 7/16 12h UNF	449081612	20,17
1"	1" 7/16 12h UNF	449081616	24,10
1"1/4	1" 11/16 12h UNF	449082020	32,54
1"1/2	2" 12h UNF	449082424	51,09

## Juntas tóricas para ORFS

O´rings for ORFS

O´rings pour ORFS

O´rings per raccordi ORFS



Ø INNER Ø INT.	Thickness (mm) Espesor (mm)	Part nº Referencia	€
7,65	1,78	7.65X1.78	0,07
9,25	1,78	9.25X1.78	0,09
12,42	1,78	12.42X1.78	0,10
15,60	1,78	15.60X1.78	0,12
18,77	1,78	18.77X1.78	0,14
23,52	1,78	23.52X1.78	0,18
29,87	1,78	29.87X1.78	0,23
37,82	1,78	37.82X1.78	0,31

# Conexiones Serie Standard

Standard series fittings  
Embouts série Standard  
Raccordi serie Standard

## Brida recta SAE 3000 PSI

3000 PSI SAE Straight Flange / Code 61

Bride SAE droite série 3000 PSI

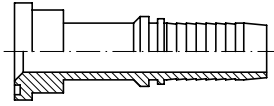

Flangia diritta SAE 3000 PSI

DN	Ø	Part nº Referencia	€
1/2"	30.2	<b>241820808</b>	<b>6,45</b>
1/2"	38.1	<b>241821208</b>	<b>9,86</b>
5/8"	38.1	<b>241821210</b>	<b>11,18</b>
3/4"	38.1	<b>241821212</b>	<b>9,92</b>
3/4"	44.5	<b>241821612</b>	<b>16,43</b>
1"	44.5	<b>241821616</b>	<b>13,88</b>
1"	50.8	<b>241822016</b>	<b>23,93</b>
1"1/4	50.8	<b>241822020</b>	<b>19,50</b>
1"1/4	60.3	<b>241822420</b>	<b>35,89</b>
1"1/2	60.3	<b>241822424</b>	<b>37,47</b>
1"1/2	71.4	<b>241823224</b>	<b>66,81</b>
2"	71.4	<b>241823232</b>	<b>60,73</b>

## Brida recta SAE 6000 PSI

6000 PSI SAE Straight Flange / Code 62

Bride SAE droite série 6000 PSI

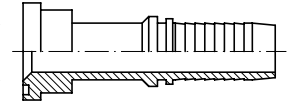

Flangia diritta SAE 6000 PSI

DN	Ø	Part nº Referencia	€
1/2"	31.8	<b>242820808</b>	<b>7,63</b>
1/2"	41.3	<b>242821208</b>	<b>11,18</b>
5/8"	41.3	<b>242821210</b>	<b>11,84</b>
3/4"	41.3	<b>242821212</b>	<b>12,89</b>
3/4"	47.6	<b>242821612</b>	<b>18,14</b>
1"	47.6	<b>242821616</b>	<b>18,67</b>
1"	54	<b>242822016</b>	<b>24,71</b>
1"1/4	54	<b>242822020</b>	<b>26,03</b>
1"1/4	63.5	<b>242822420</b>	<b>37,87</b>
1"1/2	63.5	<b>242822424</b>	<b>40,10</b>
1"1/2	79.4	<b>242823224</b>	<b>72,66</b>
2"	79.4	<b>242823232</b>	<b>55,33</b>

## Brida a 90° SAE 3000 PSI

3000 PSI SAE Flange (90° Elbow) / Code 61

Bride SAE coude 90° série 3000 PSI

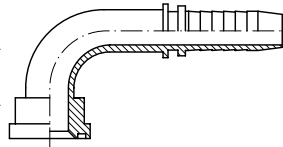

Flangia a 90° SAE 3000 PSI

DN	Ø	Part nº Referencia	€
1/2"	30.2	<b>241830808</b>	<b>8,51</b>
1/2"	38.1	<b>241831208</b>	<b>12,08</b>
5/8"	38.1	<b>241831210</b>	<b>12,38</b>
3/4"	38.1	<b>241831212</b>	<b>12,32</b>
3/4"	44.5	<b>241831612</b>	<b>18,79</b>
1"	44.5	<b>241831616</b>	<b>19,29</b>
1"	50.8	<b>241832016</b>	<b>27,19</b>
1"1/4	50.8	<b>241832020</b>	<b>28,40</b>
1"1/4	60.3	<b>241832420</b>	<b>40,85</b>
1"1/2	60.3	<b>241832424</b>	<b>42,16</b>
1"1/2	71.4	<b>241833224</b>	<b>73,53</b>
2"	71.4	<b>241833232</b>	<b>78,44</b>

## Brida a 90° SAE 6000 PSI

6000 PSI SAE Flange (90° Elbow) / Code 62

Bride SAE coude 90° série 6000 PSI

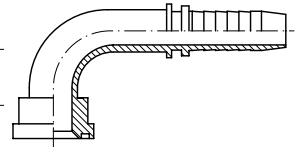

Flangia a 90° SAE 6000 PSI

DN	Ø	Part nº Referencia	€
1/2"	31.8	<b>242830808</b>	<b>9,18</b>
1/2"	41.3	<b>242831208</b>	<b>14,05</b>
5/8"	41.3	<b>242831210</b>	<b>12,60</b>
3/4"	41.3	<b>242831212</b>	<b>12,81</b>
3/4"	47.6	<b>242831612</b>	<b>20,42</b>
1"	47.6	<b>242831616</b>	<b>20,91</b>
1"	54	<b>242832016</b>	<b>29,30</b>
1"1/4	54	<b>242832020</b>	<b>30,21</b>
1"1/4	63.5	<b>242832420</b>	<b>43,79</b>
1"1/2	63.5	<b>242832424</b>	<b>45,43</b>
1"1/2	79.4	<b>242833224</b>	<b>78,44</b>

## Brida a 45° SAE 3000 PSI

3000 PSI SAE Flange (45° Elbow) / Code 61

Bride SAE coude 45° série 3000 PSI

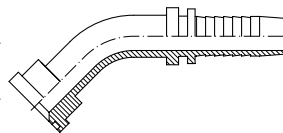

Flangia a 45° SAE 3000 PSI

DN	Ø	Part nº Referencia	€
1/2"	30.2	<b>241840808</b>	<b>8,51</b>
1/2"	38.1	<b>241841208</b>	<b>12,08</b>
5/8"	38.1	<b>241841210</b>	<b>12,38</b>
3/4"	38.1	<b>241841212</b>	<b>12,32</b>
3/4"	44.5	<b>241841612</b>	<b>18,79</b>
1"	44.5	<b>241841616</b>	<b>19,29</b>
1"	50.8	<b>241842016</b>	<b>27,19</b>
1"1/4	50.8	<b>241842020</b>	<b>28,40</b>
1"1/4	60.3	<b>241842420</b>	<b>40,85</b>
1"1/2	60.3	<b>241842424</b>	<b>42,16</b>
1"1/2	71.4	<b>241843224</b>	<b>73,53</b>
2"	71.4	<b>241843232</b>	<b>78,44</b>

## Brida a 45° SAE 6000 PSI

6000 PSI SAE Flange (45° Elbow) / Code 62

Bride SAE coude 45° série 6000 PSI

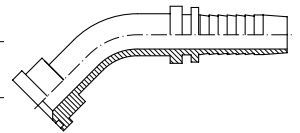

Flangia a 45° SAE 6000 PSI

DN	Ø	Part nº Referencia	€
1/2"	31.8	<b>242840808</b>	<b>9,18</b>
1/2"	41.3	<b>242841208</b>	<b>14,05</b>
5/8"	41.3	<b>242841210</b>	<b>12,60</b>
3/4"	41.3	<b>242841212</b>	<b>12,81</b>
3/4"	47.6	<b>242841612</b>	<b>20,42</b>
1"	47.6	<b>242841616</b>	<b>20,91</b>
1"	54	<b>242842016</b>	<b>29,30</b>
1"1/4	54	<b>242842020</b>	<b>30,21</b>
1"1/4	63.5	<b>242842420</b>	<b>43,79</b>
1"1/2	63.5	<b>242842424</b>	<b>45,43</b>
1"1/2	79.4	<b>242843224</b>	<b>78,44</b>
2"	79.4	<b>242843232</b>	<b>80,06</b>

# Conexiones Serie Standard

Standard series fittings  
Emboutis série Standard  
Raccordi serie Standard

## Brida recta 9000 PSI (14,3)

9000 PSI straight Flange (14,3)

Bride tournante droite série 9000 PSI (14,3)

Flangia diritta PSI 9000 (14,3)

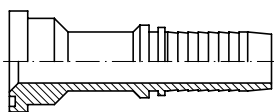

DN	Ø	Part n° Referencia	€
1/2"	41,3	<b>442821212</b>	<b>13,62</b>
3/4"	47,6	<b>442821612</b>	<b>22,07</b>
1"	47,6	<b>442821616</b>	<b>22,07</b>
1"	54	<b>442822016</b>	<b>27,59</b>
1" 1/4	54	<b>442822020</b>	<b>27,59</b>
1" 1/2	63,5	<b>442822424</b>	<b>48,08</b>

## Brida a 45° 9000 PSI (14,3)

9000 PSI 45° Flange (14,3)

Bride tournante coude 45° série 9000 PSI (14,3)

Flangia a 45° PSI 9000 (14,3)

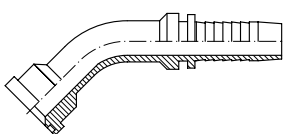

DN	Ø	Part n° Referencia	€
3/4"	41,3	<b>442841212</b>	<b>17,57</b>
3/4"	47,6	<b>442841612</b>	<b>27,59</b>
1"	47,6	<b>442841616</b>	<b>27,59</b>
1"	54	<b>442842016</b>	<b>38,28</b>
1" 1/4	54	<b>442842020</b>	<b>38,28</b>
1" 1/2	63,5	<b>442842424</b>	<b>48,08</b>

## Brida a 90° 9000 PSI (14,3)

9000 PSI 90° Flange (14,3)

Bride tournante coude 90° série 9000 PSI (14,3)

Flangia a 90° PSI 9000 (14,3)

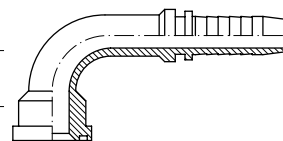

DN	Ø	Part n° Referencia	€
3/4"	41,3	<b>442831212</b>	<b>17,57</b>
3/4"	47,6	<b>442831612</b>	<b>27,59</b>
1"	47,6	<b>442831616</b>	<b>27,59</b>
1"	54	<b>442832016</b>	<b>38,28</b>
1" 1/4	54	<b>442832020</b>	<b>38,28</b>
1" 1/2	63,5	<b>442832424</b>	<b>48,08</b>

# Conexiones Serie Standard

Standard series fittings  
Embouts série Standard  
Raccordi serie Standard

## Bridas SAE partidas (semibridas) 3000/6000 PSI

### 3000/6000 PSI SAE Split flanges

Demi-brides rectangulaires de fixation SAE  
3000/6000 PSI

### Semiflanguia SAE 3000/6000 PSI

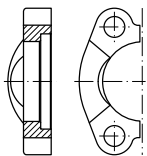

SERIE	SIZE TAMAÑO	Part nº Referencia	€
3000 PSI	1/2"	<b>BBP308</b>	<b>4,90</b>
3000 PSI	3/4"	<b>BBP312</b>	<b>5,56</b>
3000 PSI	1"	<b>BBP316</b>	<b>6,09</b>
3000 PSI	1"1/4	<b>BBP320</b>	<b>7,76</b>
3000 PSI	1"1/2	<b>BBP324</b>	<b>9,80</b>
3000 PSI	2"	<b>BBP332</b>	<b>11,59</b>
3000 PSI	2"1/2	<b>BBP340</b>	<b>22,93</b>
3000 PSI	3"	<b>BBP348</b>	<b>44,88</b>
3000 PSI	3"1/2	<b>BBP356</b>	<b>51,32</b>
3000 PSI	4"	<b>BBP364</b>	<b>54,25</b>
6000 PSI	1/2"	<b>BBP608</b>	<b>5,85</b>
6000 PSI	3/4"	<b>BBP612</b>	<b>7,66</b>
6000 PSI	1"	<b>BBP616</b>	<b>11,89</b>
6000 PSI	1"1/4	<b>BBP620</b>	<b>16,74</b>
6000 PSI	1"1/2	<b>BBP624</b>	<b>24,90</b>
6000 PSI	2"	<b>BBP632</b>	<b>38,08</b>

€/par / €/pair / €/paire / €/coppia

## Bridas SAE enteras (monoblock) 3000/6000 PSI

### 3000/6000 PSI SAE Flanges

Brides monobloc rectangulaires de fixation SAE  
3000/6000 PSI

### Flanguia SAE 3000/6000 PSI

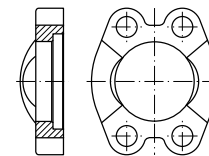

SERIE	SIZE TAMAÑO	Part nº Referencia	€
3000 PSI	1/2"	<b>BBE308</b>	<b>4,90</b>
3000 PSI	3/4"	<b>BBE312</b>	<b>7,18</b>
3000 PSI	1"	<b>BBE316</b>	<b>6,09</b>
3000 PSI	1"1/4	<b>BBE320</b>	<b>7,76</b>
3000 PSI	1"1/2	<b>BBE324</b>	<b>8,91</b>
3000 PSI	2"	<b>BBE332</b>	<b>11,59</b>
3000 PSI	2"1/2	<b>BBE340</b>	<b>25,23</b>
3000 PSI	3"	<b>BBE348</b>	<b>37,51</b>
3000 PSI	3"1/2	<b>BBE356</b>	<b>51,32</b>
3000 PSI	4"	<b>BBE364</b>	<b>70,81</b>
3000 PSI	5"	<b>BBE380</b>	<b>89,77</b>
6000 PSI	1/2"	<b>BBE608</b>	<b>6,08</b>
6000 PSI	3/4"	<b>BBE612</b>	<b>9,89</b>
6000 PSI	1"	<b>BBE616</b>	<b>11,30</b>
6000 PSI	1"1/4	<b>BBE620</b>	<b>16,74</b>
6000 PSI	1"1/2	<b>BBE624</b>	<b>34,08</b>
6000 PSI	2"	<b>BBE632</b>	<b>38,08</b>

## Tornillos para bridas SAE

### Screws for SAE flanges

### Vis pour brides SAE

### Vite per flangia SAE



THREAD ROSCA	SIZE TAMAÑO	Part nº Referencia	€
M8X30	3000-6000 PSI 1/2"	<b>TB8X30</b>	*
M10X35	3000 PSI 3/4"-1"	<b>TB10X35</b>	*
M10X40	3000 PSI 1" 1/4 - 6000 PSI 3/4"	<b>TB10X40</b>	*
M12X45	3000 PSI 1"1/2-2"-2"1/2-6000 PSI 1"	<b>TB12X45</b>	*
M14X45	6000 PSI 1"1/4	<b>TB14X45</b>	*
M16X50	3000 PSI 3"-3" 1/2-4"- 6000 PSI 1" 1/2	<b>TB16X50</b>	*
M20X70	6000 PSI 2"	<b>TB20X70</b>	*

\*Ver precios en p.251 / \*See prices in p.251 / \*Prix à la p.251 / \*Vedere prezzi p.251

## Juntas para bridas SAE 3000/6000 PSI

### Seals for 3000/6000 PSI flange

### Joints pour bride série 3000/6000

### Guarnizioni per flangia SAE 3000/6000 PSI



Ø OUTER Ø EXT.	Ø INNER Ø INT.	SIZE TAMAÑO	Part nº Referencia	€
25.40	17.02	1/2"	<b>JBR08</b>	<b>0,78</b>
31.72	23.36	3/4"	<b>JBR12</b>	<b>0,95</b>
39.62	31.24	1"	<b>JBR16</b>	<b>1,20</b>
44.45	36.07	1"1/4	<b>JBR20</b>	<b>1,66</b>
53.98	45.34	1"1/2	<b>JBR24</b>	<b>1,95</b>
63.50	54.86	2"	<b>JBR32</b>	<b>2,09</b>

## Juntas tóricas para bridas SAE 3000/6000 PSI

### O'rings for 3000/6000 PSI SAE flanges

### O'rings pour bride série 3000/6000 PSI

### O'rings per flangia SAE 3000/6000 PSI



Ø INNER Ø INT.	SIZE TAMAÑO	Part nº Referencia	€
18.64	1/2"	<b>18.64X3.53</b>	<b>0,22</b>
24.99	3/4"	<b>24.99X3.53</b>	<b>0,29</b>
32.92	1"	<b>32.92X3.53</b>	<b>0,39</b>
37.70	1"1/4	<b>37.70X3.53</b>	<b>0,45</b>
47.22	1"1/2	<b>47.22X3.53</b>	<b>0,59</b>
56.74	2"	<b>56.74X3.53</b>	<b>0,68</b>

# Conexiones Serie Standard

Standard series fittings  
Embouts série Standard  
Raccordi serie Standard

## Macho pistola hidrolavadora

Male terminal steel hydro-wash

Mâle fixe spécial pistolet-hydroneettoyage

Maschio pistola idropulitrice

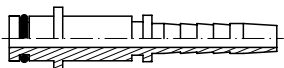

DN	Part n° Referencia	€
1/4"	<b>230400400</b>	<b>1,49</b>

## Empuñaduras de goma negras

Handle with black rubber

Poignée hydroneettoyage de gomme noire

Manopola di gomma nera



DN	Ø OUTER Ø EXT.	Ø INNER Ø INT.	Part n° Referencia	€
1/4"	29	15,5	<b>230600400</b>	<b>1,55</b>
5/16"	35	18	<b>230600500</b>	<b>1,95</b>
3/8"	35	21	<b>230600600</b>	<b>1,78</b>

## Empuñaduras de goma grises

Handle with grey rubber

Poignée hydroneettoyage de gomme grise

Manopola di gomma grigia



DN	Ø OUTER Ø EXT.	Ø INNER Ø INT.	Part n° Referencia	€
1/4"	29	15,5	<b>230610400</b>	<b>2,35</b>
5/16"	35	18	<b>230610500</b>	<b>2,98</b>
3/8"	35	22	<b>230610600</b>	<b>2,63</b>

## Hembras giratorias racor CO2 W21.8

Swivel female CO2 fitting W21.8

Raccord CO2 femelle tournante W21.8

Raccordo CO2 femmina girevole W21.8

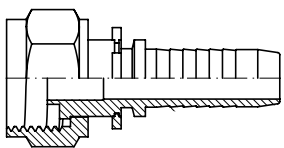

DN	THREAD ROSCA	Part n° Referencia	€
3/8"	W 21,8 1/14h	<b>2470421806</b>	<b>2,87</b>
1/2"	W 21,8 1/14h	<b>2470421808</b>	<b>2,87</b>

## Terminal Karcher acero

Swivel female steel hydro-wash

Embout femelle tournante acier spécial hydroneettoyage

Femmina in acciaio per idropultrici

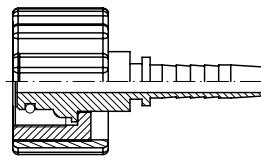

PIPE TUBO	THREAD ROSCA	DESCRIPTION DESCRIPCIÓN	Part n° Referencia	€
1/4"	M22X1.5	STD	<b>230700400</b>	<b>5,09</b>
5/16"	M22X1.5	STD	<b>230700500</b>	<b>4,76</b>
3/8"	M22X1.5	STD	<b>230700600</b>	<b>4,94</b>
1/4"	M22X1.5	Long	<b>230720400</b>	<b>5,09</b>
5/16"	M22X1.5	Long	<b>230720500</b>	<b>4,76</b>
3/8"	M22X1.5	Long	<b>230720600</b>	<b>4,94</b>

## Empuñaduras de goma azules

Handle with blue rubber

Poignée hydroneettoyage de gomme bleue

Manopola di gomma azzurra



DN	Ø OUTER Ø EXT.	Ø INNER Ø INT.	Part n° Referencia	€
1/4"	29	15,5	<b>230620400</b>	<b>2,41</b>
5/16"	35	18	<b>230620500</b>	<b>2,98</b>
3/8"	35	21	<b>230620600</b>	<b>2,63</b>



# Conexiones Serie Reusables

Reusable series fittings  
Embouts Récupérables  
Raccordi serie Recuperabile

## Casquillos R1AT

Ferrules R1AT

Jupes à visser R1AT

Boccola R1AT

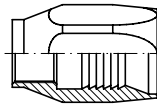

DN	Part n° Referencia	€
1/4"	<b>A1G-4 R1T</b>	<b>5,89</b>
3/8"	<b>A1G-6 R1T</b>	<b>6,52</b>
1/2"	<b>A1G-8 R1T</b>	<b>9,01</b>
3/4"	<b>A1G-12 R1T</b>	<b>14,23</b>
1"	<b>A1G-16 R1T</b>	<b>23,34</b>

## Casquillos R2AT

Ferrules R2AT

Jupes à visser R2AT

Boccola R2AT

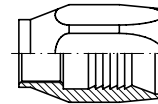

DN	Part n° Referencia	€
1/4"	<b>A1G-4 R2T</b>	<b>5,01</b>
3/8"	<b>A1G-6 R2T</b>	<b>5,58</b>
1/2"	<b>A1G-8 R2T</b>	<b>7,55</b>
5/8"	<b>A1G-10 R2T</b>	<b>15,33</b>
3/4"	<b>A1G-12 R2T</b>	<b>8,60</b>
1"	<b>A1G-16 R2T</b>	<b>*</b>

## Hembras giratorias rectas BSP cono 60°

BSP Swivel female 60° cone

Femelle tournante gaz cyl BSP 60°

Femmina diritta recuperabile BSP sede 60°

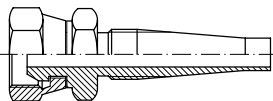

DN	THREAD ROSCA	Part n° Referencia	€
1/4"	1/4" BSP	<b>A3G-4</b>	<b>3,78</b>
5/16"	3/8" BSP	<b>A3G-6-5</b>	<b>4,66</b>
3/8"	3/8" BSP	<b>A3G-6</b>	<b>4,90</b>
1/2"	1/2" BSP	<b>A3G-8</b>	<b>8,42</b>
3/4"	3/4" BSP	<b>A3G-12</b>	<b>9,48</b>
1"	1" BSP	<b>A3G-16</b>	<b>17,39</b>

## Hembras giratorias 90° BSP cono 60°

BSP Swept 90° elbow 60° cone

Femelle tournante coude 90° gaz cyl BSP 60°

Femmina a 90° recuperabile BSP sede 60°

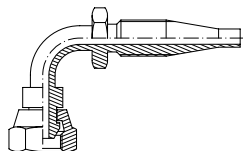

DN	THREAD ROSCA	Part n° Referencia	€
1/4"	1/4" BSP	<b>A90G-4</b>	<b>5,30</b>
3/8"	3/8" BSP	<b>A90G-6</b>	<b>6,63</b>
3/8"	1/2" BSP	<b>A90G-8-6</b>	<b>10,62</b>
1/2"	1/2" BSP	<b>A90G-8</b>	<b>9,89</b>
1/2"	3/4" BSP	<b>A90G-12-8</b>	<b>15,37</b>
3/4"	3/4" BSP	<b>A90G-12</b>	<b>15,70</b>
1"	1" BSP	<b>A90G-16</b>	<b>29,06</b>

## Machos rosca cilíndrica BSP cono 60°

BSP Male parallel 60° cone

Mâle gaz cyl BSP 60°

Maschio cilindrico recuperabile BSP sede 60°

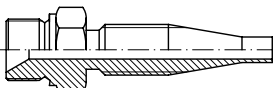

DN	THREAD ROSCA	Part n° Referencia	€
1/4"	1/4" BSP	<b>A2G-4</b>	<b>2,93</b>
5/16"	3/8" BSP	<b>A2G-6-5</b>	<b>5,16</b>
3/8"	3/8" BSP	<b>A2G-6</b>	<b>4,28</b>
3/8"	1/2" BSP	<b>A2G-8-6</b>	<b>7,16</b>
1/2"	1/2" BSP	<b>A2G-8</b>	<b>5,97</b>
1/2"	3/4" BSP	<b>A2G-12-8</b>	<b>11,77</b>
3/4"	3/4" BSP	<b>A2G-12</b>	<b>8,16</b>
1"	1" BSP	<b>A2G-16</b>	<b>15,00</b>

## Espigas lisas Métricas

Metric Standpipe

Embout lisse Métrique

Estremità tubolare Metrica recuperabile

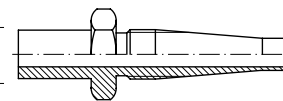

DN	PIPE TUBO	Part n° Referencia	€
1/4"	6	<b>AE 6-4</b>	<b>3,25</b>
1/4"	8	<b>AE 8-4</b>	<b>3,25</b>
1/4"	10	<b>AE 10-4</b>	<b>3,25</b>
3/8"	10	<b>AE 10-6</b>	<b>4,46</b>
3/8"	12	<b>AE 12-6</b>	<b>4,46</b>
1/2"	15	<b>AE 15-8</b>	<b>8,05</b>
3/4"	22	<b>AE 22-12</b>	<b>25,68</b>

## Hembras giratorias rectas reusables rosca JIC cono 37°

Reusable JIC 37° straight swivel female

Femelle droite récupérable JIC 37°

Femmina diritta JIC sede 37° recuperabile

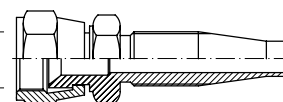

DN	THREAD ROSCA	Part n° Referencia	€
1/4"	7/16" 20h JIC	<b>A3J-07-04</b>	<b>4,68</b>
3/8"	9/16" 18h JIC	<b>A3J-09-06</b>	<b>4,77</b>
1/2"	3/4" 16h JIC	<b>A3J-12-08</b>	<b>8,38</b>
1/2"	7/8" 14h JIC	<b>A3J-14-08</b>	<b>6,56</b>
5/8"	7/8" 14h JIC	<b>A3J-14-10</b>	<b>8,72</b>
3/4"	1"1/16 12h JIC	<b>A3J-17-12</b>	<b>12,26</b>
1"	1"5/16 12h JIC	<b>A3J-21-16</b>	<b>20,09</b>

## Machos reusables rosca JIC cono 37°

Reusable JIC 37° cone male

Mâle récupérables JIC cône 37°

Maschio JIC 37° recuperabile

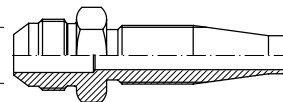

DN	THREAD ROSCA	Part n° Referencia	€
1/4"	7/16" 20h JIC	<b>A2J-07-04</b>	<b>*</b>
3/8"	9/16" 18h JIC	<b>A2J-09-06</b>	<b>*</b>
1/2"	3/4" 16h JIC	<b>A2J-12-08</b>	<b>*</b>
1/2"	7/8" 14h JIC	<b>A2J-14-08</b>	<b>*</b>
5/8"	7/8" 14h JIC	<b>A2J-14-10</b>	<b>*</b>
3/4"	1"1/16 12h JIC	<b>A2J-17-12</b>	<b>*</b>
1"	1"5/16 12h JIC	<b>A2J-21-16</b>	<b>*</b>

# Conexiones Serie BW no pelar R12 / 4SP / 4SH

BW fittings - no skiving R12 / 4SP / 4SH

Embouts BW sans dénuder R12 / 4SP / 4SH

Raccordi BW - senza pelatura R12 / 4SP / 4SH

## Casquillos R12/ 4SP/ 4SH serie BW

Ferrules R12/4SP/4SH BW series

Jupes à sertir R12/4SP/4SH série BW

Boccole pressare R12/4SP/4SH serie BW

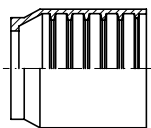

DN	Part n° Referencia	€
3/4"	<b>AC680101200</b>	<b>10,68</b>
1"	<b>AC680101600</b>	<b>13,26</b>
1" 1/4	<b>AC680102000</b>	<b>22,09</b>

## Hembras giratorias rectas BSP cono 60° con junta

BSP Swivel female 60° cone with o'ring

Femelle tournante gaz cyl BSP 60° avec joint

Femmina diritta BSP sede 60° con o'ring

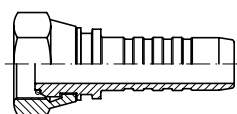

DN	THREAD ROSCA	Part n° Referencia	€
3/4"	3/4" BSP	<b>661101212</b>	<b>5,96</b>
1"	1" BSP	<b>661101616</b>	<b>9,91</b>
1" 1/4	1" 1/4 BSP	<b>661102020</b>	<b>18,79</b>

## Hembras giratorias 90° BSP cono 60° con junta

BSP Swivel female 60° cone with joint (90° Elbow)

Coude 90° femelle tournante gaz cyl BSP 60° avec joint

Femmina a 90° BSP sede 60° con o'ring

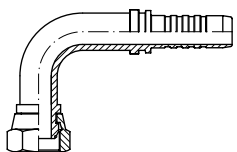

DN	THREAD ROSCA	Part n° Referencia	€
3/4"	3/4" BSP	<b>661171212</b>	<b>11,82</b>
1"	1" BSP	<b>661171616</b>	<b>17,83</b>
1" 1/4	1" 1/4 BSP	<b>661172020</b>	<b>31,19</b>

## Macho JIC 37°

JIC 37° male

Mâle JIC 37°

Maschio JIC 37°

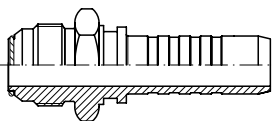

DN	THREAD ROSCA	Part n° Referencia	€
3/4"	1" 1/16 12h UNF	<b>661401712</b>	<b>5,47</b>
1"	1" 5/16 12h UNF	<b>661402116</b>	<b>10,03</b>

## Hembras giratorias rectas JIC 37° doble hexagonal

JIC 37° Swivel female doble hexagonal

Femelle JIC 37° double hexagonale

Femmina diritta JIC 37° doppio esagono

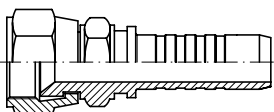

DN	THREAD ROSCA	Part n° Referencia	€
3/4"	1" 1/16 12h UNF	<b>662421712</b>	<b>7,62</b>
1"	1" 5/16 12h UNF	<b>662422116</b>	<b>12,59</b>

## Hembras giratorias 45° BSP cono 60° con junta

BSP Swivel female 60° cone with joint (45° Elbow)

Coude 45° femelle tournante gaz cyl BSP 60° avec joint

Femmina a 45° BSP sede 60° con o'ring

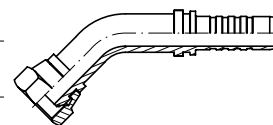

DN	THREAD ROSCA	Part n° Referencia	€
3/4"	3/4" BSP	<b>661181212</b>	<b>11,86</b>
1"	1" BSP	<b>661181616</b>	<b>18,76</b>
1" 1/4	1" 1/4 BSP	<b>661182020</b>	<b>34,06</b>

## Macho BSP cono 60°

BSP Male 60° cone

Mâle BSP cône 60°

Maschio BSP 60°

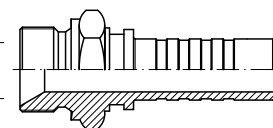

DN	THREAD ROSCA	Part n° Referencia	€
3/4"	3/4" BSP	<b>661121212</b>	<b>6,84</b>
1"	1" BSP	<b>661121616</b>	<b>10,95</b>
1" 1/4	1" 1/4 BSP	<b>661122020</b>	<b>19,54</b>

## Hembras giratorias 90° JIC 37°

JIC 37° swivel female (90° Elbow)

Coude 90° femelle JIC 37°

Femmina gir. 90° JIC 37°

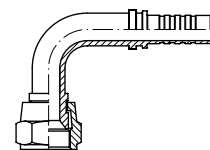

DN	THREAD ROSCA	Part n° Referencia	€
3/4"	1" 1/16 12h UNF	<b>661381712</b>	<b>13,23</b>
1"	1" 5/16 12h UNF	<b>661382116</b>	<b>18,76</b>

## Hembras giratorias 45° JIC 37°

JIC 37° swivel female (45° Elbow)

Coude 45° femelle JIC 37°

Femmina gir. 45° JIC 37°

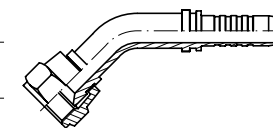

DN	THREAD ROSCA	Part n° Referencia	€
3/4"	1" 1/16 12h UNF	<b>661391712</b>	<b>12,00</b>
1"	1" 5/16 12h UNF	<b>661392116</b>	<b>18,76</b>

# Conexiones Serie BW no pelar R12 / 4SP / 4SH

BW fittings - no skiving R12 / 4SP / 4SH

Embouts BW sans dénuder R12 / 4SP / 4SH

Raccordi BW - senza pelatura R12 / 4SP / 4SH

## Hembras giratorias Métricas cono 24° con junta tórica

Metric swivel female 24° seat with o'ring

Femelle Métrique 24° avec o'ring

Femmina Metrica sede 24° con o'ring

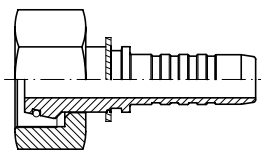

DN	THREAD ROSCA	Part n° Referencia	€
3/4"	M36X2	<b>66204362512</b>	<b>11,40</b>
1"	M42X2	<b>66204423016</b>	<b>18,79</b>
1"1/4	M52X2	<b>66204523820</b>	<b>24,20</b>

## Hembras giratorias 45° Métricas cono 24° con junta tórica

Metric swivel female 24° seat with o'ring (45° Elbow)

Coude 45° femelle Métrique 24° avec o'ring

Femmina Metrica 45° sede 24° con o'ring

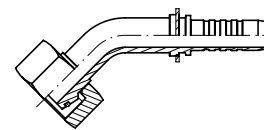

DN	THREAD ROSCA	Part n° Referencia	€
3/4"	M36X2	<b>66206362512</b>	<b>15,96</b>
1"	M42X2	<b>66206423016</b>	<b>21,89</b>
1"1/4	M52X2	<b>66206523820</b>	<b>41,69</b>

## Hembras giratorias 90° Métricas cono 24° con junta tórica

Metric swivel female 24° seat with o'ring (90° Elbow)

Coude 90° femelle Métrique 24° avec o'ring

Femmina Metrica 90° sede 24° con o'ring

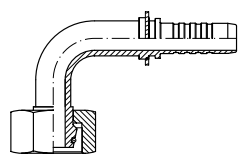

DN	THREAD ROSCA	Part n° Referencia	€
3/4"	M36X2	<b>66205362512</b>	<b>17,09</b>
1"	M42X2	<b>66205423016</b>	<b>25,02</b>
1"1/4	M52X2	<b>66205523820</b>	<b>41,69</b>

## Machos fijos Métricos cono 24°

Metric male stud 24° cone

Mâle Métrique cone 24°

Maschio Metrico sede 24° con o'ring

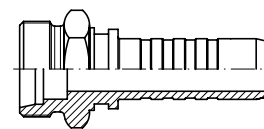

DN	THREAD ROSCA	Part n° Referencia	€
3/4"	M36X2	<b>66203362512</b>	<b>10,03</b>
1"	M42X2	<b>66203423016</b>	<b>14,59</b>

## Brida recta SAE 3000 PSI

3000 PSI SAE Straight flange

Bride SAE droite série 3000 PSI

Flangia diritta SAE 3000

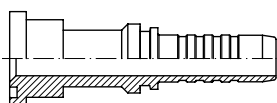

DN	Ø	Part n° Referencia	€
3/4"	38,1	<b>661821212</b>	<b>11,26</b>
1"	44,5	<b>661821616</b>	<b>15,27</b>
1"1/4	50,8	<b>661822020</b>	<b>25,34</b>

## Brida recta SAE 6000 PSI

6000 PSI SAE Straight flange

Bride SAE droite série 6000 PSI

Flangia diritta SAE 6000

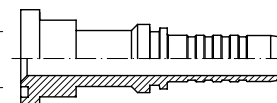

DN	Ø	Part n° Referencia	€
3/4"	41,3	<b>662821212</b>	<b>12,61</b>
1"	47,63	<b>662821616</b>	<b>16,86</b>
1"1/4	53,98	<b>662822020</b>	<b>27,41</b>

## Brida a 90° SAE 3000 PSI

3000 PSI SAE 90° Flange

Bride SAE coude 90° série 3000 PSI

Flangia 90° SAE 3000

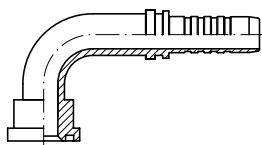

DN	Ø	Part n° Referencia	€
3/4"	38,1	<b>661831212</b>	<b>17,07</b>
1"	44,5	<b>661831616</b>	<b>21,74</b>
1"1/4	50,8	<b>661832020</b>	<b>36,72</b>

## Brida a 90° SAE 6000 PSI

6000 PSI SAE 90° Flange

Bride SAE coude 90° série 6000 PSI

Flangia 90° SAE 6000

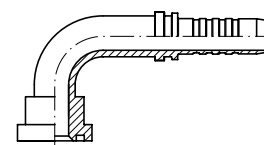

DN	Ø	Part n° Referencia	€
3/4"	41,3	<b>662831212</b>	<b>18,72</b>
1"	47,6	<b>662831616</b>	<b>25,76</b>
1"1/4	54	<b>662832020</b>	<b>42,95</b>

## Brida a 45° SAE 3000 PSI

3000 PSI SAE 45° Flange

Bride SAE coude 45° série 3000 PSI

Flangia 45° SAE 3000

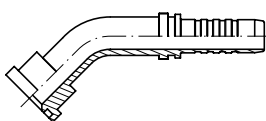

DN	Ø	Part n° Referencia	€
3/4"	38,1	<b>661841212</b>	<b>17,06</b>
1"	44,5	<b>661841616</b>	<b>23,32</b>
1"1/4	50,8	<b>661842020</b>	<b>36,72</b>

## Brida a 45° SAE 6000 PSI

6000 PSI SAE 45° flange

Bride SAE coude 45° série 6000 PSI

Flangia 45° SAE 6000

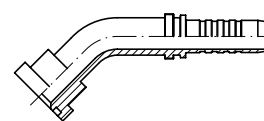

DN	Ø	Part n° Referencia	€
3/4"	41,3	<b>662841212</b>	<b>18,72</b>
1"	47,6	<b>662841616</b>	<b>25,76</b>
1"1/4	54	<b>662842020</b>	<b>43,36</b>

# Conexiones Serie BW no pelar R12 / 4SP / 4SH

*BW fittings - no skiving R12 / 4SP / 4SH*

*Embouts BW sans dénuder R12 / 4SP / 4SH*

*Raccordi BW - senza pelatura R12 / 4SP / 4SH*

Hoses

Flexible hose fittings

Flow measuring

Equipment for flexible hoses

## Hembra giratoria recta ORFS asiento plano doble hexagonal

*ORFS Swivel female straight double hexagonal*

Femelle droite ORFS double hexagonale

*Femmina diritta ORFS doppio esagono*

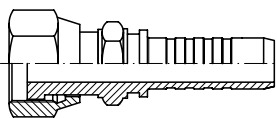

PIPE TUBO	THREAD ROSCA	Part n° Referencia	€
3/4"	1"3/16 12h UNF	<b>669011212</b>	<b>8,58</b>
1"	1"7/16 12h UNF	<b>669011616</b>	<b>13,09</b>

## Hembra giratoria 90° ORFS asiento plano

*ORFS Swivel female (90° Elbow)*

Coude 90° femelle ORFS

*Femmina 90° ORFS*

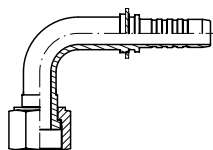

PIPE TUBO	THREAD ROSCA	Part n° Referencia	€
3/4"	1"3/16 12h UNF	<b>669071212</b>	<b>14,50</b>
1"	1"7/16 12h UNF	<b>669071616</b>	<b>22,41</b>

## Hembra giratoria 45° ORFS asiento plano

*ORFS Swivel female (45° Elbow)*

Coude 45° femelle ORFS

*Femmina 45° ORFS*

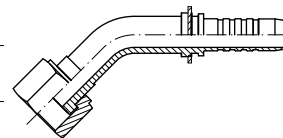

PIPE TUBO	THREAD ROSCA	Part n° Referencia	€
3/4"	1"3/16 12h UNF	<b>669081212</b>	<b>12,55</b>
1"	1"7/16 12h UNF	<b>669081616</b>	<b>18,76</b>

# Conexiones Serie Interlock

Interlock series fittings  
Embouts à sertir Interlock  
Raccordi serie Interlock

## Casquillos 4SH

Ferrules DIN 20023-4SH

Jupe à sertir DIN 20023 4SH

Boccola Interlock 4SH

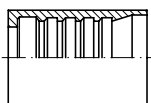

DN	DESCRIPTION DESCRIPCIÓN	Part nº Referencia	€
3/4"	4SH / R13 / R15	<b>A610101200</b>	<b>7,93</b>
1"	4SH / R13 / R15	<b>A610101600</b>	<b>14,63</b>
1"1/4	4SH	<b>A610102000</b>	<b>20,60</b>
1"1/2	4SH	<b>A610102400</b>	<b>26,00</b>
2"	4SH	<b>A610103200</b>	<b>47,28</b>

## Casquillos R13-R15

Ferrules SAE 100 R13/R15

Jupe à sertir DIN 20023 R13/R15

Boccola Interlock R13/R15

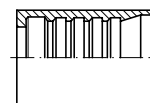

DN	DESCRIPTION DESCRIPCIÓN	Part nº Referencia	€
1"1/4	R13/R15	<b>610102000</b>	<b>22,96</b>
1"1/2	R13/R15	<b>610102400</b>	<b>33,43</b>
2"	R13/R15	<b>610103200</b>	<b>54,71</b>

## Hembras giratorias rectas BSP cono 60° con junta

BSP Swivel female 60° cone + o'ring

Femelle tournante gaz cyl BSP 60° + o'ring

Femmina diritta BSP sede 60° con o'ring

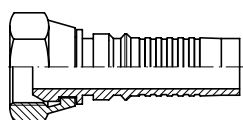

DN	THREAD ROSCA	Part nº Referencia	€
3/4"	3/4" BSP	<b>641001212</b>	<b>6,62</b>
1"	1" BSP	<b>641001616</b>	<b>12,00</b>
1"1/4	1"1/4 BSP	<b>641002020</b>	<b>17,96</b>
1"1/2	1"1/2 BSP	<b>641002424</b>	<b>34,75</b>
2"	2" BSP	<b>641003232</b>	<b>55,27</b>

## Macho rosca cilíndrica BSP cono 60°

BSP Male 60° cone

Mâle fixe gaz cyl BSP 60°

Maschio cilindrico BSP sede 60°

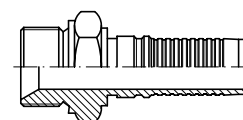

DN	THREAD ROSCA	Part nº Referencia	€
3/4"	3/4" BSP	<b>641121212</b>	<b>7,05</b>
1"	1" BSP	<b>641121616</b>	<b>16,07</b>
1"1/4	1"1/4 BSP	<b>641122020</b>	<b>17,96</b>
1"1/2	1"1/2 BSP	<b>641122424</b>	<b>39,04</b>
2"	2" BSP	<b>641123232</b>	<b>56,58</b>

## Hembras giratorias 90° BSP cono 60° con junta

BSP Swivel female 60° cone + o'ring (90° Elbow)

Femelle tournante coude 90° gaz cyl BSP 60° + o'ring

Femmina a 90° BSP sede 60° con o'ring

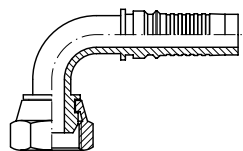

DN	THREAD ROSCA	Part nº Referencia	€
3/4"	3/4" BSP	<b>641071212</b>	<b>11,12</b>
1"	1" BSP	<b>641071616</b>	<b>20,90</b>
1"1/4	1"1/4 BSP	<b>641072020</b>	<b>33,13</b>
1"1/2	1"1/2 BSP	<b>641072424</b>	<b>58,56</b>
2"	2" BSP	<b>641073232</b>	<b>84,97</b>

## Macho rosca NPT

NPT Male

Mâle fixe NPT

Maschio conico NPT

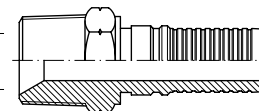

DN	THREAD ROSCA	Part nº Referencia	€
3/4"	3/4" NPT	<b>641611212</b>	<b>6,59</b>
1"	1" NPT	<b>641611616</b>	<b>11,82</b>
1"1/4	1"1/4 NPT	<b>641612020</b>	<b>20,94</b>
1"1/2	1"1/2 NPT	<b>641612424</b>	<b>34,80</b>
2"	2" NPT	<b>641613232</b>	<b>50,50</b>

## Hembras giratorias 45° BSP cono 60° con junta

BSP Swivel female 60° cone + o'ring (45° Elbow)

Femelle tournante coude 45° gaz cyl BSP 60° + o'ring

Femmina a 45° BSP sede 60° con o'ring

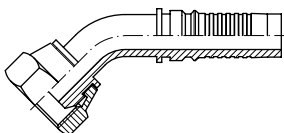

DN	THREAD ROSCA	Part nº Referencia	€
3/4"	3/4" BSP	<b>641081212</b>	<b>13,48</b>
1"	1" BSP	<b>641081616</b>	<b>25,99</b>
1"1/4	1"1/4 BSP	<b>641082020</b>	<b>34,59</b>
1"1/2	1"1/2 BSP	<b>641082424</b>	<b>53,99</b>
2"	2" BSP	<b>641083232</b>	<b>84,97</b>

# Conexiones Serie Interlock

Interlock series fittings  
Embouts à sertir Interlock  
Raccordi serie Interlock

Hoses

Flexible hose fittings

Flow measuring

Equipment for flexible hoses

## Hembras giratorias rectas JIC 37°

JIC 37° Swivel female

Femelle tournante JIC 37°

Femmina diritta JIC 37°

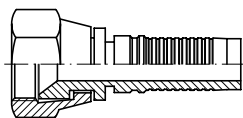

DN	THREAD ROSCA	Part nº Referencia	€
3/4"	1"1/16 12h UNF	<b>641421712</b>	<b>5,86</b>
1"	1"5/16 12h UNF	<b>641422116</b>	<b>12,00</b>
1"1/4	1"5/8 12h UNF	<b>641422620</b>	<b>17,18</b>
1"1/2	1"7/8 12h UNF	<b>641423024</b>	<b>31,65</b>
2"	2"1/2 12h UNF	<b>641424032</b>	<b>60,65</b>

## Hembras giratorias 45° JIC 37°

JIC 37° Swivel female (45° Elbow)

Femelle tournante coude 45° JIC 37°

Femmina a 45° JIC 37°

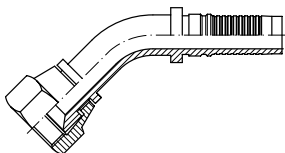

DN	THREAD ROSCA	Part nº Referencia	€
3/4"	1"1/16 12h UNF	<b>641391712</b>	<b>13,48</b>
1"	1"5/16 12h UNF	<b>641392116</b>	<b>22,71</b>
1"1/4	1"5/8 12h UNF	<b>641392620</b>	<b>37,21</b>
1"1/2	1"7/8 12h UNF	<b>641393024</b>	<b>52,17</b>
2"	2"1/2 12h UNF	<b>641394032</b>	<b>97,04</b>

## Hembra giratoria recta Métrica cono 24° con junta tórica

Metric swivel female 24° seat with o'ring

Femelle tournante Métrique 24° + o'ring

Femmina Metrica sede 24° con o'ring

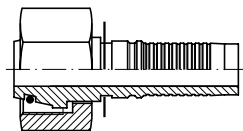

DN	PIPE TUBO	SERIE	THREAD ROSCA	Part nº Referencia	€
3/4"	20	S	M30X2	<b>64204302012</b>	<b>8,44</b>
3/4"	25	S	M36X2	<b>64204362512</b>	<b>9,08</b>
1"	30	S	M42X2	<b>64204423016</b>	<b>18,91</b>
1"1/4	38	S	M52X2	<b>64204523820</b>	<b>27,41</b>

## Hembra giratoria 45° Métrica cono 24° con junta tórica

Metric swivel female 24° seat with o'ring (45° Elbow)

Femelle tournante coude 45° Métrique + o'ring

Femmina a 45° sede 24° con o'ring

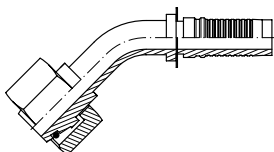

DN	PIPE TUBO	SERIE	THREAD ROSCA	Part nº Referencia	€
3/4"	20	S	M30X2	<b>64206302012</b>	<b>14,96</b>
1"	30	S	M42X2	<b>64206423016</b>	<b>23,41</b>
1"1/4	38	S	M52X2	<b>64206523820</b>	<b>47,70</b>

## Hembras giratorias 90° JIC 37°

JIC 37° Swivel female (90° Elbow)

Femelle tournante coude 90° JIC 37°

Femmina a 90° JIC 37°

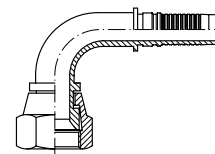

DN	THREAD ROSCA	Part nº Referencia	€
3/4"	1"1/16 12h UNF	<b>641381712</b>	<b>13,90</b>
1"	1"5/16 12h UNF	<b>641382116</b>	<b>24,17</b>
1"1/4	1"5/8 12h UNF	<b>641382620</b>	<b>26,31</b>
1"1/2	1"7/8 12h UNF	<b>641383024</b>	<b>52,17</b>
2"	2"1/2 12h UNF	<b>641384032</b>	<b>84,46</b>

## Macho JIC 37°

JIC 37° male

Mâle fixe JIC 37°

Maschio JIC 37°

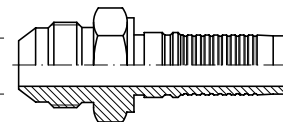

DN	THREAD ROSCA	Part nº Referencia	€
3/4"	1"1/16 12h UNF	<b>641401712</b>	<b>7,62</b>
1"	1"5/16 12h UNF	<b>641402116</b>	<b>12,40</b>
1"1/4	1"5/8 12h UNF	<b>641402620</b>	<b>20,48</b>
1"1/2	1"7/8 12h UNF	<b>641403024</b>	<b>33,16</b>
2"	2"1/2 12h UNF	<b>641404032</b>	<b>55,27</b>

## Hembra giratoria 90° Métrica cono 24° con junta tórica

Metric swivel female 24° seat with o'ring (90° Elbow)

Femelle tournante coude 90° Métrique + o'ring

Femmina a 90° Metrica sede 24° con o'ring

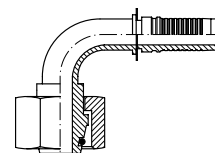

DN	PIPE TUBO	SERIE	THREAD ROSCA	Part nº Referencia	€
3/4"	20	S	M30X2	<b>64205302012</b>	<b>15,41</b>
3/4"	25	S	M36X2	<b>64205362512</b>	<b>20,52</b>
1"	30	S	M42X2	<b>64205423016</b>	<b>22,16</b>
1"1/4	38	S	M52X2	<b>64205523820</b>	<b>41,50</b>

## Macho rosca Métrica cono 24°

Metric male stud 24° cone

Mâle fixe Métrique 24° série lourde

Maschio Metrico sede 24°

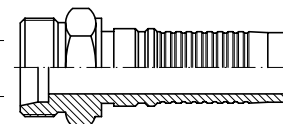

DN	PIPE TUBO	SERIE	THREAD ROSCA	Part nº Referencia	€
3/4"	20	S	M30X2	<b>64203302012</b>	<b>7,89</b>
3/4"	25	S	M36X2	<b>64203362512</b>	<b>11,47</b>
1"	30	S	M42X2	<b>64203423016</b>	<b>18,72</b>
1"1/4	38	S	M52X2	<b>64203523820</b>	<b>27,36</b>

# Conexiones Serie Interlock

Interlock series fittings  
Embouts à sertir Interlock  
Raccordi serie Interlock

## Hembra giratoria recta Métrica cono 24° C/J martillos

Metric swivel female 24° seat with o'ring for hammer

Femelle tournante Métrique 24° + o'ring pour marteau

Femmina Metrica sede 24° con o'ring per martello

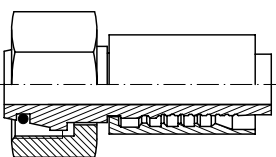

DN	PIPE TUBO	SERIE	THREAD ROSCA	Part nº Referencia	€
3/4"	25	S	M36X2	<b>NAM362512</b>	<b>52,03</b>
1"	30	S	M42X2	<b>NAM423016</b>	<b>62,37</b>
1"1/4	38	S	M52X2	<b>NAM523820</b>	<b>72,28</b>

Se venden con casquillo Interlock incluido (mismo diámetro de prensado que los casquillos A61010...) / With Interlock ferrule included (same crimping diameter as ferrule A61010) / Avec jupe Interlock incluse (même diamètre de sertissage que la jupe A61010) / Con boccola Interlock inclusa (diametro di pressatura uguale alla boccola A61010)

## Hembras rectas ORFS

ORFS Swivel female

Femelle droite ORFS

Femmina diritta ORFS Interlock

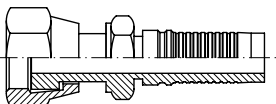

PIPE TUBO	THREAD ROSCA	Part nº Referencia	€
3/4"	1"3/16 12h UNF	<b>649001212</b>	<b>9,94</b>
1"	1"7/16 12h UNF	<b>649001616</b>	<b>12,37</b>
1"1/4	1"11/16 12h UNF	<b>649002020</b>	<b>25,08</b>
1"1/2	2" 12h UNF	<b>649002424</b>	<b>29,80</b>

## Codos 45° ORFS

ORFS Swivel female (45° Elbow)

Coude 45° femelle ORFS

Curva a 45° ORFS Interlock

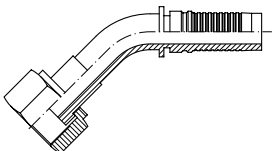

PIPE TUBO	THREAD ROSCA	Part nº Referencia	€
3/4"	1"3/16 12h UNF	<b>649081212</b>	<b>14,32</b>
1"	1"7/16 12h UNF	<b>649081616</b>	<b>24,54</b>
1"1/4	1"11/16 12h UNF	<b>649082020</b>	<b>37,21</b>

## Codos 90° ORFS

ORFS Swivel female (90° Elbow)

Coude 90° femelle ORFS

Curva a 90° ORFS Interlock

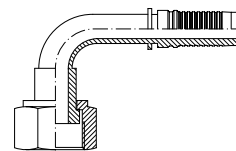

PIPE TUBO	THREAD ROSCA	Part nº Referencia	€
3/4"	1"3/16 12h UNF	<b>649071212</b>	<b>15,41</b>
1"	1"7/16 12h UNF	<b>649071616</b>	<b>24,54</b>
1"1/4	1"11/16 12h UNF	<b>649072020</b>	<b>32,20</b>
1"1/2	2" 12h UNF	<b>649072424</b>	<b>46,28</b>

# Conexiones Serie Interlock

Interlock series fittings  
Embouts à sertir Interlock  
Raccordi serie Interlock

Hoses

Flexible hose fittings

Flow measuring

Equipment for flexible hoses

## Brida SAE 3000 PSI

3000 PSI SAE Straight Flange / Code 61

Bride SAE droite série 3000 PSI

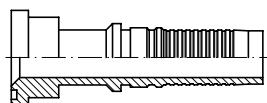

Flangia SAE 3000 PSI

DN	Ø	Part nº Referencia	€
3/4"	38.1	<b>641821212</b>	<b>11,32</b>
3/4"	44.5	<b>641821612</b>	<b>15,55</b>
1"	44.5	<b>641821616</b>	<b>17,34</b>
1"	50.8	<b>641822016</b>	<b>21,79</b>
1"1/4	50.8	<b>641822020</b>	<b>26,03</b>
1"1/4	60.3	<b>641822420</b>	<b>37,89</b>
1"1/2	60.3	<b>641822424</b>	<b>44,96</b>
2"	71.4	<b>641823232</b>	<b>71,02</b>

## Brida SAE 6000 PSI

6000 PSI SAE Straight Flange / Code 62

Bride SAE droite série 6000 PSI

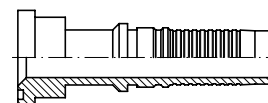

Flangia SAE 6000 PSI

DN	Ø	Part nº Referencia	€
3/4"	41.3	<b>642821212</b>	<b>10,51</b>
3/4"	47.63	<b>642821612</b>	<b>15,05</b>
1"	47.63	<b>642821616</b>	<b>19,02</b>
1"	53.98	<b>642822016</b>	<b>22,73</b>
1"1/4	53.98	<b>642822020</b>	<b>29,98</b>
1"1/4	63.5	<b>642822420</b>	<b>46,22</b>
1"1/2	63.5	<b>642822424</b>	<b>42,46</b>
2"	79.4	<b>642823232</b>	<b>122,99</b>

## Brida a 90° SAE 3000 PSI

3000 PSI SAE Flange (90° Elbow) / Code 61

Bride SAE coude 90° série 3000 PSI

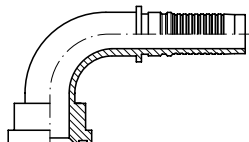

Flangia a 90° SAE 3000 PSI

DN	Ø	Part nº Referencia	€
3/4"	38.1	<b>641831212</b>	<b>17,06</b>
3/4"	44.5	<b>641831612</b>	<b>23,30</b>
1"	44.5	<b>641831616</b>	<b>21,32</b>
1"	50.8	<b>641832016</b>	<b>32,96</b>
1"1/4	50.8	<b>641832020</b>	<b>32,49</b>
1"1/4	60.3	<b>641832420</b>	<b>51,25</b>
1"1/2	60.3	<b>641832424</b>	<b>58,34</b>
2"	71.4	<b>641833232</b>	<b>104,49</b>

## Brida a 90° SAE 6000 PSI

6000 PSI SAE Flange (90° Elbow) / Code 62

Bride SAE coude 90° série 6000 PSI

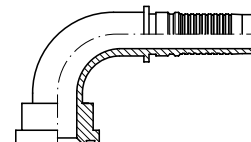

Flangia a 90° SAE 6000 PSI

DN	Ø	Part nº Referencia	€
3/4"	41.3	<b>642831212</b>	<b>17,02</b>
3/4"	47.6	<b>642831612</b>	<b>25,26</b>
1"	47.6	<b>642831616</b>	<b>26,92</b>
1"	54	<b>642832016</b>	<b>40,07</b>
1"1/4	54	<b>642832020</b>	<b>35,65</b>
1"1/4	63.5	<b>642832420</b>	<b>61,27</b>
1"1/2	63.5	<b>642832424</b>	<b>77,20</b>
2"	79.4	<b>642833232</b>	<b>179,00</b>

## Brida a 45° SAE 3000 PSI

3000 PSI SAE Flange (45° Elbow) / Code 61

Bride SAE coude 45° série 3000 PSI

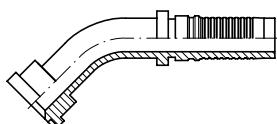

Flangia a 45° SAE 3000 PSI

DN	Ø	Part nº Referencia	€
3/4"	38.1	<b>641841212</b>	<b>17,07</b>
3/4"	44.5	<b>641841612</b>	<b>23,33</b>
1"	44.5	<b>641841616</b>	<b>25,63</b>
1"1/4	50.8	<b>641842020</b>	<b>38,42</b>
1"1/4	60.3	<b>641842420</b>	<b>51,59</b>
1"1/2	60.3	<b>641842424</b>	<b>53,56</b>
2"	71.4	<b>641843232</b>	<b>122,43</b>

## Brida a 45° SAE 6000 PSI

6000 PSI SAE Flange (45° Elbow) / Code 62

Bride SAE coude 45° série 6000 PSI

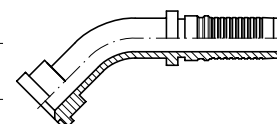

Flangia a 45° SAE 6000 PSI

DN	Ø	Part nº Referencia	€
3/4"	41.3	<b>642841212</b>	<b>17,02</b>
3/4"	47.6	<b>642841612</b>	<b>26,97</b>
1"	47.6	<b>642841616</b>	<b>29,20</b>
1"	54	<b>642842016</b>	<b>40,44</b>
1"1/4	54	<b>642842020</b>	<b>38,96</b>
1"1/2	63.5	<b>642842424</b>	<b>67,17</b>
2"	79.4	<b>642843232</b>	<b>144,40</b>

# Conexiones Serie Interlock

Interlock series fittings  
Embouts à sertir Interlock  
Raccordi serie Interlock

## Brida 9000 PSI (14,3)

9000 PSI Straight flange (14,3)

Bride droite série 9000 PSI (14,3)

Flangia 9000 PSI (14,3)

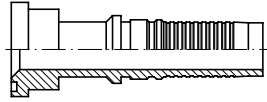

DN	Ø	Part nº Referencia	€
3/4"	41,3	<b>643821212</b>	<b>15,76</b>
1"	47,6	<b>643821616</b>	<b>23,20</b>
1"	54	<b>643822016</b>	<b>31,35</b>
1"1/4	54	<b>643822020</b>	<b>29,86</b>
1"1/4	63,5	<b>643822420</b>	<b>47,20</b>
1"1/2	63,5	<b>643822424</b>	<b>43,50</b>

## Brida a 45° 9000 PSI (14,3)

45° 9000 PSI Flange (14,3)

Bride coude 45° série 9000 PSI (14,3)

Flangia a 45° 9000 PSI (14,3)

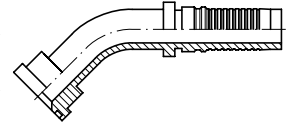

DN	Ø	Part nº Referencia	€
3/4"	41,3	<b>643841212</b>	<b>18,63</b>
1"	47,6	<b>643841616</b>	<b>30,72</b>
1"	54	<b>643842016</b>	<b>41,64</b>
1"1/4	54	<b>643842020</b>	<b>43,80</b>
1"1/2	63,5	<b>643842424</b>	<b>71,56</b>

## Brida a 90° 9000 PSI (14,3)

90° 9000 PSI Flange (14,3)

Bride coude 90° série 9000 PSI (14,3)

Flangia a 90° 9000 PSI (14,3)

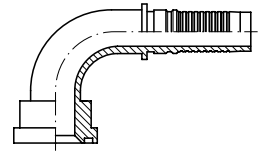

DN	Ø	Part nº Referencia	€
3/4"	41,3	<b>643831212</b>	<b>20,35</b>
1"	47,6	<b>643831616</b>	<b>34,84</b>
1"	54	<b>643832016</b>	<b>58,76</b>
1"1/4	54	<b>643832020</b>	<b>62,07</b>
1"1/2	63,5	<b>643832424</b>	<b>82,13</b>

# Conexiones Serie Interlock

Interlock series fittings  
Embout à sertir Interlock  
Raccordi serie Interlock

Hoses

Flexible hose fittings

Flow measuring

Equipment for flexible hoses

## Espiga para brida macho Poclairn

Poclairn male flange

Embout bride mâle Poclairn

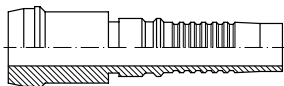

Inserto per flangia maschio Poclairn 4SH

DN	Ø	Part nº Referencia	€
3/4"	3/4"	<b>648011212</b>	<b>14,77</b>
1"	1"	<b>648011616</b>	<b>36,54</b>
1"1/4	1"1/4	<b>648012020</b>	<b>46,93</b>

Hasta fin de existencias. / Until end of stock. / Jusqu'à la fin du stock. / Fino ad esaurimento scorta.

## Espiga para brida hembra Poclairn

Poclairn female flange

Embout bride femelle Poclairn

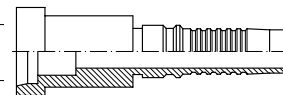

Inserto per flangia femmina Poclairn 4SH

DN	Ø	Part nº Referencia	€
3/4"	3/4"	<b>648021212</b>	<b>28,41</b>
1"	1"	<b>648021616</b>	<b>29,33</b>
1"1/4	1"1/4	<b>648022020</b>	<b>43,26</b>

Hasta fin de existencias. / Until end of stock. / Jusqu'à la fin du stock. / Fino ad esaurimento scorta.

## Brida entera macho Poclairn 4 agujeros

Male Poclairn flange 4 holes

Bride rectangulaire de fixation mâle Poclairn-4 trous

Flangia intera maschio Poclairn 4 fori

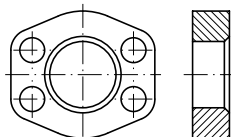

SIZE TAMAÑO	Part nº Referencia	€
3/4"	<b>448051212</b>	<b>35,98</b>
1"	<b>448051616</b>	<b>42,90</b>
1"1/4	<b>448052020</b>	<b>56,99</b>

Hasta fin de existencias. / Until end of stock. / Jusqu'à la fin du stock. / Fino ad esaurimento scorta.

## Brida entera hembra Poclairn 4 agujeros

Female Poclairn flange 4 holes

Bride rectangulaire de fixation femelle Poclairn-4 trous

Flangia intera femmina Poclairn 4 fori

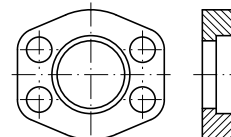

SIZE TAMAÑO	Part nº Referencia	€
3/4"	<b>448061212</b>	<b>51,41</b>
1"	<b>448061616</b>	<b>58,47</b>
1"1/4	<b>448062020</b>	<b>72,97</b>

Hasta fin de existencias. / Until end of stock. / Jusqu'à la fin du stock. / Fino ad esaurimento scorta.

## Brida entera macho Poclairn 2 agujeros

Male Poclairn flange 2 holes

Bride ovale fixation mâle Poclairn 2 trous

Flangia intera maschio Poclairn 2 fori

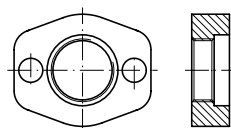

PIPE TUBO	Part nº Referencia	€
5/8"	<b>448071010</b>	<b>29,92</b>
3/4"	<b>448071212</b>	<b>29,33</b>
1"	<b>448071616</b>	<b>35,76</b>
1"1/4	<b>448072020</b>	<b>56,96</b>

Hasta fin de existencias. / Until end of stock. / Jusqu'à la fin du stock. / Fino ad esaurimento scorta.

# Conexiones Alta presión (700 Bar)

High pressure 700 Bar fittings

Embouts haute pression 700 Bar

Raccordi altissima pressione (700 Bar)

## Manguera termoplástica 700 bar

Thermoplastic hose 700 bar

Tuyau thermoplastique haute pression 700 bar



Tube termoplastico 700 bar

DN	Part n° Referencia	€
1/4"	<b>MT70004</b>	<b>23,10</b>
3/8"	<b>MT70006</b>	<b>54,44</b>

## Casquillos manguera 700 bar tipo MT700

Ferrules for thermoplastic hose 700 bar MT700 type

Jupes à sertir thermoplastique 700 bar type MT700

Boccole per tubo termoplastico 700 bar tipo MT700

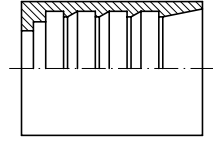

DN	Part n° Referencia	€
1/4"	<b>710120400</b>	<b>2,04</b>
3/8"	<b>710120600</b>	<b>2,90</b>

## Hembra giratoria recta BSP 60°

BSP Swivel female 60° cone

Embout thermoplastique 700 bar femelle tournante gaz cyl BSP 60°

Femmina diritta BSP sede 60°

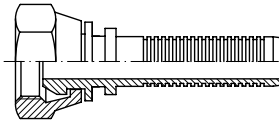

DN	THREAD ROSCA	Part n° Referencia	€
1/4"	1/4" BSP	<b>741000404</b>	<b>5,01</b>
3/8"	3/8" BSP	<b>741000606</b>	<b>4,01</b>

## Macho BSP 60°

BSP Male parallel 60° cone

Embout thermoplastique 700 bar mâle fixe gaz cyl BSP 60°

Maschio cilindrico BSP sede 60°

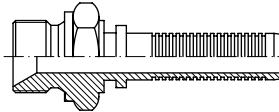

DN	THREAD ROSCA	Part n° Referencia	€
1/4"	1/4" BSP	<b>741120404</b>	<b>3,71</b>
3/8"	3/8" BSP	<b>741120606</b>	<b>4,35</b>

## Macho NPT

NPT Male thread

Embout thermoplastique 700 bar mâle fixe gaz conique NPT

Maschio conico NPT

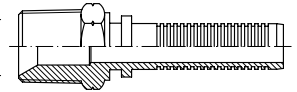

DN	THREAD ROSCA	Part n° Referencia	€
1/4"	1/4" NPT	<b>741610404</b>	<b>2,99</b>
1/4"	3/8" NPT	<b>741610604</b>	<b>2,63</b>
3/8"	3/8" NPT	<b>741610606</b>	<b>3,54</b>

# Serie Compacta

One Piece Series  
Série Pré-sertis  
Serie Compatti

## ■ Conexiones compactas 1SC / 1SN / 2SC / R6 / 2TE

One piece fittings 1SC / 1SN / 2SC / R6 / 2TE  
Embouts pré-sertis 1SC / 1SN / 2SC / R6 / 2TE  
Raccordi compatti 1SC / 1SN / 2SC / R6 / 2TE

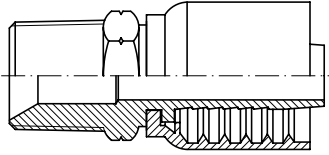

EN 857 1SC	EN 853 1 SN SAE 100 R1AT	EN 857 2SC	EN 854 SAE 100 R6	EN 854 2TE
---------------	-----------------------------------	---------------	-------------------------	---------------

## ■ Conexiones compactas Serie 43 R1AT / R2AT / 1SN / 2SN / R16 / 2SC / 3TE / R17

One piece fittings 43 Series R1AT / R2AT / 1SN / 2SN / R16 / 2SC / 3TE / R17  
Embouts pré-sertis R1AT / R2AT / 1SN / 2SN / R16 / 2SC Série 43 / 2TE / R17  
Raccordi compatti R1AT / R2AT / 1SN / 2SN / R16 / 2SC Serie 43 / 3TE / R17

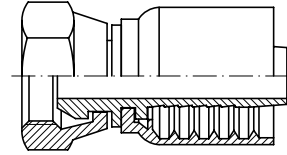

EN 853 1SN SAE 100 R1AT	EN 853 2 SN SAE 100 R2AT	EN 857 2SC SAE 100 R16	SUPERSERVICE 155° 2SC	3TE ----- R17
----------------------------------	-----------------------------------	---------------------------------	-----------------------------	---------------------

## ■ Conexiones compactas Serie Standard NO PELAR 3SP / 4SP / 4SH / R12

One piece fittings Standar Series NON SKIVE 3SP / 4SP / 4SH / R12  
Embouts pré-sertis SANS DÉNUDÉ 3SP / 4SP / 4SH / R12  
Raccordi compatti SENZA PELATURA 3SP / 4SP / 4SH / R12

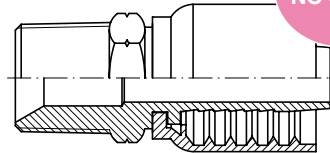

NO PELAR  
NO SKIVE

3SP	EN 856 4SP SAE 100 R9R	EN 856 4SH	EN856 R12 SAE 100
-----	------------------------------	---------------	-------------------------

## ■ Conexiones compactas R7 / R8 y elastómero malla metálica

Piece fittings R7 / R8 & braid of steel wire  
Embouts pré-sertis R7 / R8 et tresse métallique  
Raccordi compatti serie R7 / R8 e elastomero treccia metallica

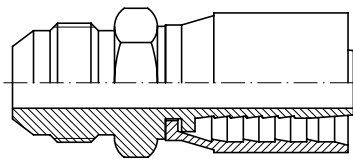

SAE 100 R7	SAE 100 R8	Metallic braid elastomer
---------------	---------------	--------------------------------

## ■ Conexiones compactas PTFE liso

One piece fittings for smooth PTFE  
Embouts pré-sertis pour PTFE lisse  
Raccordi compatti serie PTFE liscio

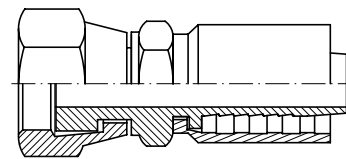

Smooth PTFE 1 braid
---------------------------

## ■ Conexiones compactas PTFE corrugado

One piece fittings for convoluted PTFE  
Embouts pré-sertis pour PTFE convolute  
Raccordi compatti serie PTFE convoluto

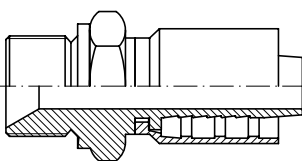

Convoluted PTFE
--------------------

## ■ Conexiones compactas Serie BW R12 / 4SP / 4SH

One piece fittings BW Series R12 / 4SP / 4SH  
Embouts pré-sertis R12 / 4SP / 4SH Série BW  
Raccordi compatti R12 / 4SP / 4SH Serie BW

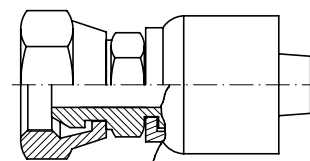

EN 856 R12	EN 856 4SP	4 SH
---------------	---------------	------

# Casquillos Una sola pieza

Ferrules for One Piece Fittings

Jupes pour Embouts une seule pièce

Boccole per Raccordi un pezzo

## Casquillos 1SC/1SN/2SC/R6/2TE/R17

Ferrules 1SC/1SN/2SC/R6/2TE/R17

Jupes à sertir 1SC/1SN/2SC/R6/2TE/R17

Boccole a pressare per 1SC/1SN/2SC/R6/2TE/R17

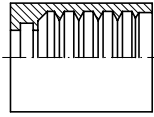

DN	Part nº Referencia	€
1/4"	SC21120400	1,23
5/16"	SC21120500	1,10
3/8"	SC21120600	1,32
1/2"	SC21120800	1,91
5/8"	SC21121000	2,60
3/4"	SC21121200	3,39
1"	SC21121600	5,83

## Casquillos 1SN/2SN/R16/2SC/3TE/R17 para conexiones de una sola pieza serie 43

Ferrules 1SN/2SN/R16/2SC/3TE/R17 for one piece fittings 43 series

Jupes 1SN/2SN/R16/2SC/3TE/R17 pour embous pré-sertis série 43

Boccole a pressare 1SN/2SN/R16/2SN/3TE/R17 per raccordi compatti serie 43

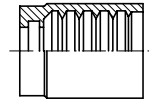

DN	Part nº Referencia	€
1/4"	PFC221200400	1,48
5/16"	PFC221200500	1,71
3/8"	PFC221200600	1,77
1/2"	PFC221200800	2,27
5/8"	PFC221201000	2,98
3/4"	PFC221201200	3,92
1"	PFC221201600	5,64
1"1/4	PFC221202000	15,32
1"1/2	PFC221202400	22,63
2"	PFC221203200	37,56

## Casquillos R12/3SP/4SP/4SH no pelar

Ferrules R12/3SP/4SP/4SH non skive

Jupes à sertir R12/3SP/4SP/4SH sans dénudage

Boccole a pressare per R12/3SP/4SP/4SH senza spellatura

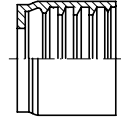

DN	Part nº Referencia	€
3/8"	DI222400600	2,19
1/2"	DI222400800	2,58
5/8"	DI222401000	3,31
3/4"	DI222401200	4,43
1"	DI222401600	7,23
1" 1/4	DI222402000	*

## Casquillos R12, 4SP, 4SH para conexiones de una sola pieza serie BW

Ferrules R12, 4SP, 4SH for fittings BW series

Jupes R12, 4SP, 4SH pour embouts série BW

Boccole pressare R12, 4SP, 4SH per raccordi serie BW

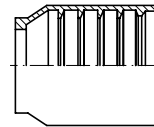

DN	Part nº Referencia	€
3/4"	AC680101200	10,68
1"	AC680101600	13,26
1" 1/4	AC680102000	22,09

# Casquillos Una sola pieza

Ferrules for One Piece Fittings  
 Jupes pour Embouts une seule pièce  
 Boccole per Raccordi un pezzo

## Casquillos R6, R7, R8 y malla metálica

Ferrules SAE 100 R6, R7, R8 and metallic braid

Jupes à sertir R6, R7, R8 et tresse métallique

Boccole a pressare per SAE R6, R7, R8 e Treccia Metallica

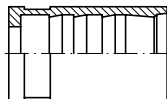

DN	Part nº Referencia	€
1/8"	<b>DI2300200</b>	<b>1,05</b>
3/16"	<b>DI2300300</b>	<b>0,84</b>
1/4"	<b>DI2300400</b>	<b>0,80</b>
5/16"	<b>DI2300500</b>	<b>1,47</b>
3/8"	<b>DI2300600</b>	<b>1,19</b>
1/2"	<b>DI2300800</b>	<b>1,53</b>
5/8"	<b>DI2301000</b>	<b>2,82</b>
3/4"	<b>DI2301200</b>	<b>4,56</b>
1"	<b>DI2301600</b>	<b>7,89</b>

## Casquillos PTFE Liso alta presión

Ferrules for Smooth PTFE

Jupes à sertir pour PTFE Lisse haute pression

Boccole a pressare per tubo al PTFE Liscio alta pressione

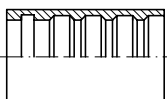

DN	Part nº Referencia	€
3/16"	<b>210400300</b>	<b>1,37</b>
1/4"	<b>210400400</b>	<b>1,02</b>
5/16"	<b>210400500</b>	<b>1,43</b>
3/8"	<b>210400600</b>	<b>1,24</b>
1/2"	<b>210400800</b>	<b>1,67</b>
5/8"	<b>210401000</b>	<b>2,18</b>
3/4"	<b>210401200</b>	<b>2,84</b>
1"	<b>210401600</b>	<b>5,11</b>

## Casquillos PTFE Corrugado alta presión

Ferrules for Corrugated PTFE

Jupes à sertir PTFE Convoluté haute pression

Boccole a pressare per tubo al PTFE Corrugato alta pressione

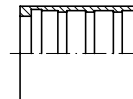

DN	Part nº Referencia	€
1/4"	<b>210410400</b>	<b>1,38</b>
3/8"	<b>210410600</b>	<b>1,59</b>
1/2"	<b>210410800</b>	<b>1,78</b>
5/8"	<b>210411000</b>	<b>3,11</b>
3/4"	<b>210411201</b>	<b>3,19</b>
1"	<b>210411600</b>	<b>5,45</b>
1" 1/4	<b>210412001</b>	<b>11,55</b>
1" 1/2	<b>210412400</b>	<b>13,51</b>
2"	<b>210413200</b>	<b>23,06</b>

# Conexiones Serie 43 una sola pieza 1SN / 2SN / R16 / 2SC / 3TE / R17

One piece fittings 43 Series 1SN / 2SN / R16 / 2SC / 3TE / R17

Embouts pré-sertis Série 43 1SN / 2SN / R16 / 2SC / 3TE / R17

Raccordi un pezzo Serie 43 1SN / 2SN / R16 / 2SC / 3TE / R17

## Hembras giratorias rectas una sola pieza JIC 37°

One piece JIC 37° female

Femelle pré-sertie JIC 37°

Femmina diritta compatta JIC 37°

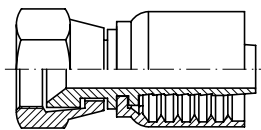

DN	THREAD ROSCA	Part n° Referencia	€
1/4"	7/16" 20h UNF	<b>281420704</b>	<b>3,20</b>
1/4"	1/2" 20h UNF	<b>281420804</b>	<b>3,43</b>
5/16"	1/2" 20h UNF	<b>281420805</b>	<b>4,27</b>
1/4"	9/16" 18h UNF	<b>281420904</b>	<b>3,33</b>
5/16"	9/16" 18h UNF	<b>281420905</b>	<b>3,60</b>
3/8"	9/16" 18h UNF	<b>281420906</b>	<b>3,80</b>
3/8"	5/8" 18h UNF	<b>281421006</b>	<b>4,91</b>
5/16"	3/4" 16h UNF	<b>281421205</b>	<b>4,38</b>
3/8"	3/4" 16h UNF	<b>281421206</b>	<b>4,29</b>
1/2"	3/4" 16h UNF	<b>281421208</b>	<b>5,15</b>
3/8"	7/8" 14h UNF	<b>281421406</b>	<b>4,99</b>
1/2"	7/8" 14h UNF	<b>281421408</b>	<b>5,40</b>
5/8"	7/8" 14h UNF	<b>281421410</b>	<b>7,00</b>
1/2"	1" 1/16 12h UNF	<b>281421708</b>	<b>7,36</b>
5/8"	1" 1/16 12h UNF	<b>281421710</b>	<b>7,94</b>
3/4"	1" 1/16 12h UN	<b>281421712</b>	<b>8,42</b>
1"	1" 1/16 12h UNF	<b>281421716</b>	<b>14,48</b>
3/4"	1" 5/16 12h UNF	<b>281422112</b>	<b>13,51</b>
1"	1" 5/16 12h UN	<b>281422116</b>	<b>15,71</b>
1"	1" 5/8 12h UNF	<b>281422616</b>	<b>21,09</b>
1" 1/4	1" 5/8 12h UN	<b>281422620</b>	<b>29,03</b>
1" 1/4	1" 7/8 12h UNF	<b>281423020</b>	<b>45,31</b>
1" 1/2	1" 7/8 12h UN	<b>281423024</b>	<b>43,95</b>
2"	2" 1/2 12h UN	<b>281424032</b>	<b>75,72</b>

## Machos una sola pieza rosca JIC 37°

One piece JIC 37° male

Mâle pré-serti JIC 37°

Maschio compatto JIC sede 37°

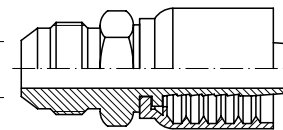

DN	THREAD ROSCA	Part n° Referencia	€
1/4"	7/16" 20h UNF	<b>281400704</b>	<b>3,10</b>
1/4"	1/2" 20 H UNF	<b>281400804</b>	<b>4,13</b>
5/16"	1/2" 20h UNF	<b>281400805</b>	<b>4,19</b>
1/4"	9/16" 18h UNF	<b>281400904</b>	<b>3,40</b>
5/16"	9/16" 18h UNF	<b>281400905</b>	<b>3,87</b>
3/8"	9/16" 18h UNF	<b>281400906</b>	<b>3,58</b>
3/8"	3/4" 16 h UNF	<b>281401206</b>	<b>4,26</b>
1/2"	3/4" 16h UNF	<b>281401208</b>	<b>4,56</b>
3/8"	7/8" 14h UNF	<b>281401406</b>	<b>5,18</b>
1/2"	7/8" 14h UNF	<b>281401408</b>	<b>5,29</b>
5/8"	7/8" 14h UNF	<b>281401410</b>	<b>6,60</b>
1/2"	1" 1/16 12h UNF	<b>281401708</b>	<b>7,36</b>
5/8"	1" 1/16-12h UNF	<b>281401710</b>	<b>7,73</b>
3/4"	1" 1/16 12h UN	<b>281401712</b>	<b>9,93</b>
3/4"	1" 5/16 12h UNF	<b>281402112</b>	<b>12,33</b>
1"	1" 5/16 12h UN	<b>281402116</b>	<b>16,12</b>
1"	1" 5/8 12h UNF	<b>281402616</b>	<b>22,38</b>
1" 1/4	1" 5/8 12h UN	<b>281402620</b>	<b>33,82</b>
1" 1/4	1" 7/8 12h UNF	<b>281403020</b>	<b>41,15</b>
1" 1/2	1" 7/8 12h UN	<b>281403024</b>	<b>48,46</b>
2"	2" 1/2 12h UN	<b>281404032</b>	<b>84,84</b>

## Hembras giratorias rectas una sola pieza JIC 37° doble hexagonal

One piece double hexagonal JIC 37° female

Femelle pré-sertie JIC 37° double hexagonal

Femmina diritta JIC 37° doppio esagono

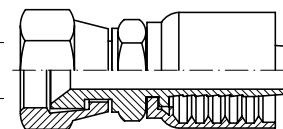

DN	THREAD ROSCA	Part n° Referencia	€
1/4"	7/16" 20h UNF	<b>282420704</b>	<b>3,90</b>
1/4"	1/2" 20h UNF	<b>282420804</b>	<b>4,13</b>
5/16"	9/16" 18h UNF	<b>282420905</b>	<b>4,89</b>
3/8"	9/16" 18h UNF	<b>282420906</b>	<b>4,95</b>
3/8"	3/4" 16h UNF	<b>282421206</b>	<b>5,26</b>
1/2"	3/4" 16h UNF	<b>282421208</b>	<b>6,29</b>
1/2"	7/8" 14h UNF	<b>282421408</b>	<b>7,28</b>
3/4"	1" 1/16 12h UN	<b>282421712</b>	<b>11,35</b>
1"	1" 5/16 12h UN	<b>282422116</b>	<b>15,78</b>
1" 1/4	1" 5/8 12h UN	<b>282422620</b>	<b>36,54</b>
1" 1/2	1" 7/8 12h UN	<b>282423024</b>	<b>54,93</b>
2"	2" 1/2 12h UN	<b>282424032</b>	<b>97,05</b>

# Conexiones Serie 43 una sola pieza 1SN / 2SN / R16 / 2SC / 3TE / R17

One piece fittings 43 Series 1SN / 2SN / R16 / 2SC / 3TE / R17

Embouts pré-sertis Série 43 1SN / 2SN / R16 / 2SC / 3TE / R17

Raccordi un pezzo Serie 43 1SN / 2SN / R16 / 2SC / 3TE / R17

## Hembras giratorias 90° una sola pieza JIC 37°

One piece JIC 37° Female (90° Elbow)

Coude 90° femelle pré-sertie JIC 37°

Femmina 90° compatta JIC 37°

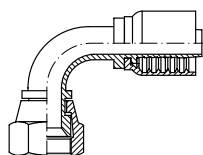

DN	THREAD ROSCA	Part nº Referencia	€
1/4"	7/16" 20h UNF	<b>281380704</b>	<b>4,02</b>
1/4"	1/2" 20h UNF	<b>281380804</b>	<b>5,23</b>
1/4"	9/16" 18h UNF	<b>281380904</b>	<b>4,41</b>
5/16"	9/16" 18h UNF	<b>281380905</b>	<b>5,38</b>
3/8"	9/16" 18h UNF	<b>281380906</b>	<b>4,96</b>
3/8"	5/8" 18h UNF	<b>281381006</b>	<b>6,66</b>
3/8"	3/4" 16h UNF	<b>281381206</b>	<b>5,76</b>
1/2"	3/4" 16h UNF	<b>281381208</b>	<b>6,65</b>
3/8"	7/8" 14h UNF	<b>281381406</b>	<b>8,82</b>
1/2"	7/8" 14h UNF	<b>281381408</b>	<b>7,10</b>
5/8"	7/8" 14h UNF	<b>281381410</b>	<b>11,16</b>
1/2"	1"1/16 12h UNF	<b>281381708</b>	<b>13,55</b>
5/8"	1"1/16 12h UNF	<b>281381710</b>	<b>12,88</b>
3/4"	1"1/16 12h UN	<b>281381712</b>	<b>13,19</b>
3/4"	1"5/16 12h UNF	<b>281382112</b>	<b>20,67</b>
1"	1"5/16 12h UN	<b>281382116</b>	<b>19,97</b>
1"	1"5/8 12h UNF	<b>281382616</b>	<b>34,88</b>
1"1/4	1"5/8 12h UN	<b>281382620</b>	<b>43,82</b>
1" 1/4	1"7/8 12h UNF	<b>281383020</b>	<b>60,76</b>
1"1/2	1"7/8 12h UN	<b>281383024</b>	<b>63,57</b>
2"	2"1/2 12h UN	<b>281384032</b>	<b>123,83</b>

## Hembras giratorias 45° una sola pieza JIC 37°

One piece JIC 37° Female (45° Elbow)

Coude 45° femelle pré-sertie JIC 37°

Femmina 45° compatta JIC 37°

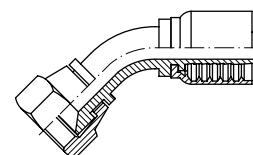

DN	THREAD ROSCA	Part nº Referencia	€
1/4"	7/16" 20h UNF	<b>281390704</b>	<b>4,59</b>
1/4"	1/2" 20h UNF	<b>281390804</b>	<b>5,15</b>
1/4"	9/16" 18h UNF	<b>281390904</b>	<b>5,19</b>
5/16"	9/16" 18h UNF	<b>281390905</b>	<b>5,16</b>
3/8"	9/16" 18h UNF	<b>281390906</b>	<b>5,68</b>
3/8"	3/4" 16h UNF	<b>281391206</b>	<b>7,07</b>
1/2"	3/4" 16h UNF	<b>281391208</b>	<b>7,67</b>
1/2"	7/8" 14h UNF	<b>281391408</b>	<b>8,96</b>
5/8"	7/8" 14h UNF	<b>281391410</b>	<b>9,98</b>
1/2"	1"1/16 12h UNF	<b>281391708</b>	<b>13,19</b>
5/8"	1"1/16 12h UNF	<b>281391710</b>	<b>13,29</b>
3/4"	1"1/16 12h UN	<b>281391712</b>	<b>12,91</b>
3/4"	1"5/16 12h UNF	<b>281392112</b>	<b>21,76</b>
1"	1"5/16 12h UN	<b>281392116</b>	<b>21,19</b>
1"	1"5/8 12h UNF	<b>281392616</b>	<b>34,88</b>
1"1/4	1"5/8 12h UN	<b>281392620</b>	<b>48,44</b>
1" 1/4	1"7/8 12h UNF	<b>281393020</b>	<b>64,66</b>
1"1/2	1"7/8 12h UN	<b>281393024</b>	<b>71,97</b>
2"	2"1/2 12h UN	<b>281394032</b>	<b>123,83</b>

## Machos una sola pieza rosca cónica NPT

One piece NPT male

Mâle pré-serti NPT

Maschio compatto conico NPT

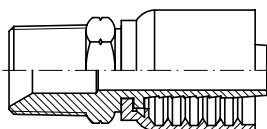

DN	THREAD ROSCA	Part nº Referencia	€
1/4"	1/8" NPT	<b>281610204</b>	<b>3,44</b>
1/4"	1/4" NPT	<b>281610404</b>	<b>3,44</b>
5/16"	1/4" NPT	<b>281610405</b>	<b>4,51</b>
3/8"	1/4" NPT	<b>281610406</b>	<b>4,57</b>
1/4"	3/8" NPT	<b>281610604</b>	<b>4,28</b>
5/16"	3/8" NPT	<b>281610605</b>	<b>4,51</b>
3/8"	3/8" NPT	<b>281610606</b>	<b>4,26</b>
1/2"	3/8" NPT	<b>281610608</b>	<b>5,60</b>
3/8"	1/2" NPT	<b>281610806</b>	<b>5,10</b>
1/2"	1/2" NPT	<b>281610808</b>	<b>5,17</b>
5/8"	1/2" NPT	<b>281610810</b>	<b>7,70</b>
1/2"	3/4" NPT	<b>281611208</b>	<b>8,17</b>
5/8"	3/4" NPT	<b>281611210</b>	<b>7,83</b>
3/4"	3/4" NPT	<b>281611212</b>	<b>8,78</b>
1"	3/4" NPT	<b>281611216</b>	<b>14,27</b>
3/4"	1" NPT	<b>281611612</b>	<b>12,55</b>
1"	1" NPT	<b>281611616</b>	<b>14,27</b>
1"	1" 1/4 NPT	<b>281612016</b>	<b>22,66</b>
1"1/4	1"1/4 NPT	<b>281612020</b>	<b>31,31</b>
1" 1/4	1"1/2 NPT	<b>281612420</b>	<b>38,02</b>
1"1/2	1"1/2 NPT	<b>281612424</b>	<b>45,33</b>
1" 1/2	2" NPT	<b>281613224</b>	<b>71,85</b>
2"	2" NPT	<b>281613232</b>	<b>78,98</b>

## Hembras giratorias rectas una sola pieza rosca NPSM cono 60°

One piece NPSM female 60° cone

Femelle pré-sertie NPSM cone 60°

Femmina diritta compatta NPSM sede 60°

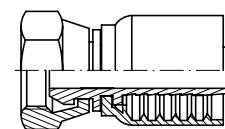

DN	THREAD ROSCA	Part nº Referencia	€
1/4"	1/4" 18h NPSM	<b>282610404</b>	<b>3,94</b>
3/8"	3/8" 18h NPSM	<b>282610606</b>	<b>4,61</b>
1/2"	1/2" 14h NPSM	<b>282610808</b>	<b>5,85</b>
3/4"	3/4" 14h NPSM	<b>282611212</b>	<b>9,46</b>
1"	1" - 11 1/2 h NPSM	<b>282611616</b>	<b>14,62</b>

# Conexiones Serie 43 una sola pieza 1SN / 2SN / R16 / 2SC / 3TE / R17

One piece fittings 43 Series 1SN / 2SN / R16 / 2SC / 3TE / R17

Embouts pré-sertis Série 43 1SN / 2SN / R16 / 2SC / 3TE / R17

Raccordi un pezzo Serie 43 1SN / 2SN / R16 / 2SC / 3TE / R17

## Hembras giratorias rectas una sola pieza ORFS

One piece ORFS female

Femelle pré-sertie ORFS

Femmina diritta compatta ORFS

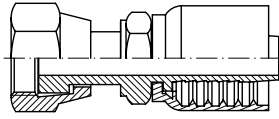

DN	THREAD ROSCA	Part nº Referencia	€
1/4"	9/16" 18h	<b>289000904</b>	<b>4,31</b>
1/4"	11/16" 16h	<b>289001104</b>	<b>4,82</b>
5/16"	11/16" 16h	<b>289001105</b>	<b>5,05</b>
3/8"	11/16" 16h	<b>289001106</b>	<b>4,95</b>
3/8"	13/16" 16h	<b>289001306</b>	<b>5,75</b>
1/2"	13/16" 16h	<b>289001308</b>	<b>5,41</b>
1/2"	1" 14h	<b>289001608</b>	<b>7,66</b>
5/8"	1" 14h	<b>289001610</b>	<b>9,26</b>
1/2"	1"3/16 12h	<b>289001908</b>	<b>10,16</b>
3/4"	1"3/16 12h	<b>289001912</b>	<b>11,51</b>
3/4"	1"7/16 12h	<b>289002312</b>	<b>16,83</b>
1"	1"7/16 12h	<b>289002316</b>	<b>14,44</b>
1"1/4	1"11/16 12h	<b>289002720</b>	<b>36,47</b>
1"1/2	2" 12h	<b>289003224</b>	<b>58,40</b>

## Hembras giratorias 90° una sola pieza ORFS

One piece ORFS female (90° Elbow)

Coude 90° femelle pré-sertie ORFS

Femmina 90° compatta ORFS

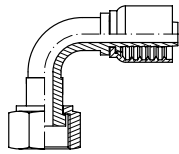

DN	THREAD ROSCA	Part nº Referencia	€
1/4"	9/16" 18h	<b>289070904</b>	<b>5,29</b>
1/4"	11/16" 16h	<b>289071104</b>	<b>6,33</b>
5/16"	11/16" 16h	<b>289071105</b>	<b>6,56</b>
3/8"	11/16" 16h	<b>289071106</b>	<b>6,15</b>
3/8"	13/16" 16h	<b>289071306</b>	<b>8,19</b>
1/2"	13/16" 16h	<b>289071308</b>	<b>8,23</b>
1/2"	1" 14h	<b>289071608</b>	<b>11,90</b>
5/8"	1" 14h	<b>289071610</b>	<b>12,78</b>
1/2"	1"3/16 12h	<b>289071908</b>	<b>15,41</b>
3/4"	1"3/16 12h	<b>289071912</b>	<b>15,89</b>
3/4"	1"7/16 12h	<b>289072312</b>	<b>24,53</b>
1"	1"7/16 12h	<b>289072316</b>	<b>26,25</b>
1"1/4	1"11/16 12h	<b>289072720</b>	<b>52,53</b>
1"1/2	2" 12h	<b>289073224</b>	<b>74,38</b>

## Machos una sola pieza ORFS

One piece ORFS male

Mâle pré-serti ORFS

Maschio compatto ORFS

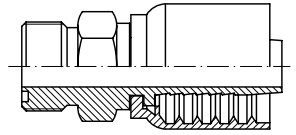

DN	THREAD ROSCA	Part nº Referencia	€
1/4"	9/16" 18h	<b>289120904</b>	<b>3,91</b>
1/4"	11/16" 16h	<b>289121104</b>	<b>4,48</b>
5/16"	11/16" 16h	<b>289121105</b>	<b>4,71</b>
3/8"	11/16" 16h	<b>289121106</b>	<b>5,08</b>
3/8"	13/16" 16h	<b>289121306</b>	<b>6,07</b>
1/2"	13/16" 16h	<b>289121308</b>	<b>6,57</b>
1/2"	1" 14h	<b>289121608</b>	<b>7,47</b>
5/8"	1" 14h	<b>289121610</b>	<b>8,57</b>
1/2"	1"3/16 12h	<b>289121908</b>	<b>10,97</b>
3/4"	1"3/16 12h	<b>289121912</b>	<b>12,73</b>
3/4"	1"7/16 12h	<b>289122312</b>	<b>18,22</b>
1"	1"7/16 12h	<b>289122316</b>	<b>19,94</b>
1"1/4	1"11/16 12h	<b>289122720</b>	<b>39,34</b>

## Hembras giratorias 45° una sola pieza ORFS

One piece ORFS female (45° Elbow)

Coude 45° femelle pré-sertie ORFS

Femmina 45° compatta ORFS



DN	THREAD ROSCA	Part nº Referencia	€
1/4"	9/16" 18h	<b>289080904</b>	<b>4,48</b>
1/2"	1" 14h	<b>289081008</b>	<b>11,54</b>
1/4"	11/16" 16h	<b>289081104</b>	<b>6,33</b>
5/16"	11/16" 16h	<b>289081105</b>	<b>6,56</b>
3/8"	11/16" 16h	<b>289081106</b>	<b>6,31</b>
3/8"	13/16" 16h	<b>289081306</b>	<b>8,25</b>
1/2"	13/16" 16h	<b>289081308</b>	<b>8,89</b>
5/8"	1" 14h	<b>289081610</b>	<b>12,73</b>
1/2"	1"3/16 12h	<b>289081908</b>	<b>15,41</b>
3/4"	1"3/16 12h	<b>289081912</b>	<b>18,31</b>
3/4"	1"7/16 12h	<b>289082312</b>	<b>24,53</b>
1"	1"7/16 12h	<b>289082316</b>	<b>30,18</b>
1"1/4	1"11/16 12h	<b>289082720</b>	<b>48,52</b>
1"1/2	2" 12h	<b>289083224</b>	<b>74,38</b>

# Conexiones Serie 43 una sola pieza 1SN / 2SN / R16 / 2SC / 3TE / R17

One piece fittings 43 Series 1SN / 2SN / R16 / 2SC / 3TE / R17

Embouts pré-sertis Série 43 1SN / 2SN / R16 / 2SC / 3TE / R17

Raccordi un pezzo Serie 43 1SN / 2SN / R16 / 2SC / 3TE / R17

Hoses

Flexible hose fittings

Flow measuring

Equipment for flexible hoses

## Bridas rectas una sola pieza SAE 3000 PSI

One piece 3000 PSI SAE Straight Flange / Code 61

Bride SAE droite pré-sertie série 3000 PSI

Flangia diritta compatta SAE 3000 PSI

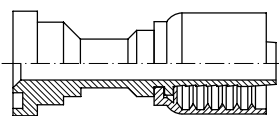

DN	Ø	Part n° Referencia	€
1/2"	30.2	<b>281820808</b>	<b>8,86</b>
1/2"	38.1	<b>281821208</b>	<b>12,17</b>
5/8"	38.1	<b>281821210</b>	<b>14,27</b>
3/4"	38.1	<b>281821212</b>	<b>13,99</b>
3/4"	44.5	<b>281821612</b>	<b>20,31</b>
1"	44.5	<b>281821616</b>	<b>19,56</b>
1"	50.8	<b>281822016</b>	<b>29,31</b>
1"1/4	50.8	<b>281822020</b>	<b>34,91</b>
1" 1/4	60.3	<b>281822420</b>	<b>50,82</b>
1"1/2	60.3	<b>281822424</b>	<b>59,66</b>
1" 1/2	71.4	<b>281823224</b>	<b>88,15</b>
2"	71.4	<b>281823232</b>	<b>97,18</b>

## Bridas rectas una sola pieza SAE 6000 PSI

One piece 6000 PSI SAE Straight Flange / Code 62

Bride SAE droite pré-sertie série 6000 PSI

Flangia diritta compatta SAE 6000 PSI

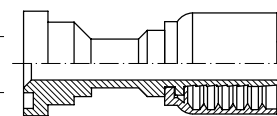

DN	Ø	Part n° Referencia	€
1/2"	31.8	<b>282820808</b>	<b>10,01</b>
1/2"	41.3	<b>282821208</b>	<b>13,45</b>
5/8"	41.3	<b>282821210</b>	<b>14,91</b>
3/4"	41.3	<b>282821212</b>	<b>16,87</b>
3/4"	47.6	<b>282821612</b>	<b>21,98</b>
1"	47.6	<b>282821616</b>	<b>24,21</b>
1"	54	<b>282822016</b>	<b>30,07</b>
1"1/4	54	<b>282822020</b>	<b>41,25</b>
1" 1/4	63.5	<b>282822420</b>	<b>52,74</b>
1"1/2	63.5	<b>282822424</b>	<b>62,22</b>
1" 1/2	79.4	<b>282823224</b>	<b>93,83</b>
2"	79.4	<b>282823232</b>	<b>91,94</b>

## Bridas 90° una sola pieza SAE 3000 PSI

One piece 3000 PSI SAE 90° Flange / Code 61

Bride SAE coude 90° pré-sertie série 3000 PSI

Flangia 90° compatta SAE 3000 PSI

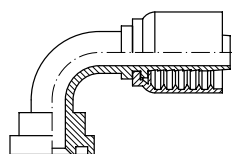

DN	Ø	Part n° Referencia	€
1/2"	30.2	<b>281830808</b>	<b>10,86</b>
1/2"	38.1	<b>281831208</b>	<b>14,33</b>
5/8"	38.1	<b>281831210</b>	<b>15,44</b>
3/4"	38.1	<b>281831212</b>	<b>16,32</b>
3/4"	44.5	<b>281831612</b>	<b>22,61</b>
1"	44.5	<b>281831616</b>	<b>24,80</b>
1"	50.8	<b>281832016</b>	<b>32,48</b>
1"1/4	50.8	<b>281832020</b>	<b>43,55</b>
1" 1/4	60.3	<b>281832420</b>	<b>55,64</b>
1"1/2	60.3	<b>281832424</b>	<b>64,22</b>
1" 1/2	71.4	<b>281833224</b>	<b>94,68</b>
2"	71.4	<b>281833232</b>	<b>114,37</b>

## Bridas 90° una sola pieza SAE 6000 PSI

One piece 6000 PSI SAE 90° Flange / Code 62

Bride SAE coude 90° pré-sertie série 6000 PSI

Flangia 90° compatta SAE 6000 PSI

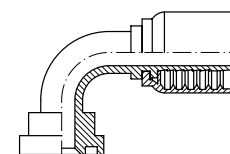

DN	Ø	Part n° Referencia	€
1/2"	31.8	<b>282830808</b>	<b>11,51</b>
1/2"	41.3	<b>282831208</b>	<b>16,24</b>
5/8"	41.3	<b>282831210</b>	<b>15,65</b>
3/4"	41.3	<b>282831212</b>	<b>16,80</b>
3/4"	47.6	<b>282831612</b>	<b>24,19</b>
1"	47.6	<b>282831616</b>	<b>26,38</b>
1"	54	<b>282832016</b>	<b>34,53</b>
1"1/4	54	<b>282832020</b>	<b>45,31</b>
1" 1/4	63.5	<b>282832420</b>	<b>58,49</b>
1"1/2	63.5	<b>282832424</b>	<b>67,40</b>
1" 1/2	79.4	<b>282833224</b>	<b>99,44</b>

## Bridas 45° una sola pieza SAE 3000 PSI

One piece 3000 PSI SAE 45° Flange / Code 61

Bride SAE coude 45° pré-sertie série 3000 PSI

Flangia 45° compatta SAE 3000 PSI

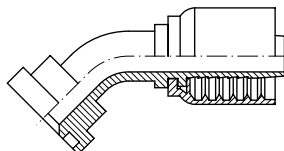

DN	Ø	Part n° Referencia	€
1/2"	30.2	<b>281840808</b>	<b>10,86</b>
1/2"	38.1	<b>281841208</b>	<b>14,33</b>
5/8"	38.1	<b>281841210</b>	<b>15,44</b>
3/4"	38.1	<b>281841212</b>	<b>16,32</b>
3/4"	44.5	<b>281841612</b>	<b>22,61</b>
1"	44.5	<b>281841616</b>	<b>24,80</b>
1"	50.8	<b>281842016</b>	<b>32,48</b>
1"1/4	50.8	<b>281842020</b>	<b>43,55</b>
1" 1/4	60.3	<b>281842420</b>	<b>55,64</b>
1"1/2	60.3	<b>281842424</b>	<b>64,22</b>
1" 1/2	71.4	<b>281843224</b>	<b>94,68</b>
2"	71.4	<b>281843232</b>	<b>114,37</b>

## Bridas 45° una sola pieza SAE 6000 PSI

One piece 6000 PSI SAE 45° Flange / Code 62

Bride SAE coude 45° pré-sertie série 6000 PSI

Flangia 45° compatta SAE 6000 PSI

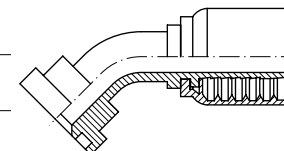

DN	Ø	Part n° Referencia	€
1/2"	31.8	<b>282840808</b>	<b>11,51</b>
1/2"	41.3	<b>282841208</b>	<b>16,24</b>
5/8"	41.3	<b>282841210</b>	<b>15,65</b>
3/4"	41.3	<b>282841212</b>	<b>16,80</b>
3/4"	47.6	<b>282841612</b>	<b>24,19</b>
1"	47.6	<b>282841616</b>	<b>26,38</b>
1"	54	<b>282842016</b>	<b>34,53</b>
1"1/4	54	<b>282842020</b>	<b>45,31</b>
1" 1/4	63.5	<b>282842420</b>	<b>58,49</b>
1"1/2	63.5	<b>282842424</b>	<b>67,40</b>
1" 1/2	79.4	<b>282843224</b>	<b>99,44</b>
2"	79.4	<b>282843232</b>	<b>115,95</b>

# Conexiones Serie 43 una sola pieza 1SN / 2SN / R16 / 2SC / 3TE / R17

One piece fittings 43 Series 1SN / 2SN / R16 / 2SC / 3TE / R17

Embouts pré-sertis Série 43 1SN / 2SN / R16 / 2SC / 3TE / R17

Raccordi un pezzo Serie 43 1SN / 2SN / R16 / 2SC / 3TE / R17

## Bridas rectas una sola pieza SAE 9000 PSI

One piece 9000 PSI SAE Straight Flange / Code 61

Bride SAE droite pré-sertie série 9000 PSI

Flangia diritta compatta SAE 9000 PSI

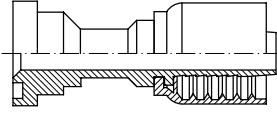

DN	Ø	Part n° Referencia	€
1/2"	41.3	<b>482821212</b>	<b>17,59</b>
3/4"	47.6	<b>482821612</b>	<b>25,79</b>
1"	47.6	<b>482821616</b>	<b>27,51</b>
1"	54	<b>482822016</b>	<b>32,86</b>
1" 1/4	54	<b>482822020</b>	<b>42,76</b>
1" 1/2	63.5	<b>482822424</b>	<b>69,97</b>

## Bridas 45° una sola pieza SAE 9000 PSI

One piece 9000 PSI SAE 45° Flange / Code 61

Bride SAE coude 45° pré-sertie série 9000 PSI

Flangia 45° compatta SAE 9000 PSI

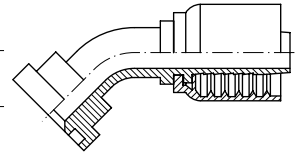

DN	Ø	Part n° Referencia	€
1/2"	41.3	<b>482841212</b>	<b>21,41</b>
3/4"	47.6	<b>482841612</b>	<b>31,14</b>
1"	47.6	<b>482841616</b>	<b>32,86</b>
1"	54	<b>482842016</b>	<b>43,25</b>
1" 1/4	54	<b>482842020</b>	<b>53,15</b>
1" 1/2	63.5	<b>482842424</b>	<b>69,97</b>

## Bridas 90° una sola pieza SAE 9000 PSI

One piece 9000 PSI SAE 90° Flange / Code 61

Bride SAE coude 90° pré-sertie série 9000 PSI

Flangia 90° compatta SAE 9000 PSI

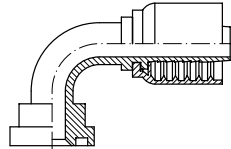

DN	Ø	Part n° Referencia	€
1/2"	41.3	<b>482831212</b>	<b>21,41</b>
3/4"	47.6	<b>482831612</b>	<b>31,14</b>
1"	47.6	<b>482831616</b>	<b>32,86</b>
1"	54	<b>482832016</b>	<b>43,25</b>
1" 1/4	54	<b>482832020</b>	<b>53,15</b>
1" 1/2	63.5	<b>482832424</b>	<b>69,97</b>

# Conexiones Serie 43 una sola pieza 1SN / 2SN / R16 / 2SC / 3TE / R17

One piece fittings 43 Series 1SN / 2SN / R16 / 2SC / 3TE / R17

Embouts pré-sertis Série 43 1SN / 2SN / R16 / 2SC / 3TE / R17

Raccordi un pezzo Serie 43 1SN / 2SN / R16 / 2SC / 3TE / R17

Hoses

Flexible hose fittings

Flow measuring

Equipment for flexible hoses

## Hembras giratorias rectas una sola pieza rosca Métrica cono 24° - DKO

One piece Metric female cone 24°

Femelle pré-sertie Métrique cone 24°

Femmina diritta compatta Metrica sede 24°

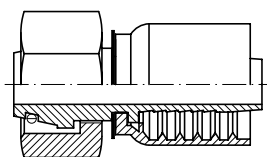

DN	PIPE TUBO	SERIE	THREAD ROSCA	Part nº Referencia	€
1/4"	6	L	M12x1.5	<b>28804120604</b>	<b>3,33</b>
1/4"	8	L	M14x1.5	<b>28804140804</b>	<b>3,22</b>
1/4"	10	L	M16x1.5	<b>28804161004</b>	<b>3,51</b>
5/16"	10	L	M16x1.5	<b>28804161005</b>	<b>3,82</b>
3/8"	10	L	M16x1.5	<b>28804161006</b>	<b>4,35</b>
1/4"	12	L	M18x1.5	<b>28804181204</b>	<b>3,84</b>
5/16"	12	L	M18x1.5	<b>28804181205</b>	<b>3,97</b>
3/8"	12	L	M18x1.5	<b>28804181206</b>	<b>3,93</b>
3/8"	15	L	M22x1.5	<b>28804221506</b>	<b>5,16</b>
1/2"	15	L	M22x1.5	<b>28804221508</b>	<b>5,20</b>
1/2"	18	L	M26x1.5	<b>28804261808</b>	<b>7,09</b>
5/8"	18	L	M26x1.5	<b>28804261810</b>	<b>6,69</b>
3/4"	22	L	M30x2	<b>28804302212</b>	<b>9,38</b>
1"	28	L	M36x2	<b>28804362816</b>	<b>15,90</b>
1"1/4	35	L	M45x2	<b>28804453520</b>	<b>31,09</b>
1"1/2	42	L	M52x2	<b>28804524224</b>	<b>44,13</b>
1/4"	8	S	M16x1.5	<b>28804160804</b>	<b>3,63</b>
1/4"	10	S	M18x1.5	<b>28804181004</b>	<b>4,08</b>
5/16"	12	S	M20x1.5	<b>28804201205</b>	<b>3,97</b>
3/8"	12	S	M20x1.5	<b>28804201206</b>	<b>4,11</b>
1/2"	12	S	M20x1.5	<b>28804201208</b>	<b>7,47</b>
3/8"	14	S	M22x1.5	<b>28804221406</b>	<b>4,99</b>
1/2"	16	S	M24x1.5	<b>28804241608</b>	<b>5,82</b>
5/8"	20	S	M30x2	<b>28804302010</b>	<b>7,56</b>
3/4"	20	S	M30x2	<b>28804302012</b>	<b>10,16</b>
3/4"	25	S	M36x2	<b>28804362512</b>	<b>13,59</b>
1"	25	S	M36x2	<b>28804362516</b>	<b>17,53</b>
1"	30	S	M42x2	<b>28804423016</b>	<b>19,59</b>
1"1/4	38	S	M52x2	<b>28804523820</b>	<b>35,55</b>

## Machos una sola pieza rosca Métrica cono 24°

One piece Metric male cone 24°

Mâle pré-serti Métrique cone 24°

Maschio compatto Metrico sede 24°

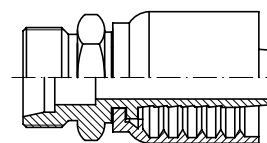

DN	PIPE TUBO	SERIE	THREAD ROSCA	Part nº Referencia	€
1/4"	6	L	M12x1.5	<b>28203120604</b>	<b>3,34</b>
1/4"	8	L	M14x1.5	<b>28203140804</b>	<b>3,37</b>
1/4"	10	L	M16x1.5	<b>28203161004</b>	<b>3,66</b>
5/16"	10	L	M16x1.5	<b>28203161005</b>	<b>3,83</b>
3/8"	10	L	M16x1.5	<b>28203161006</b>	<b>3,75</b>
1/4"	12	L	M18x1.5	<b>28203181204</b>	<b>3,66</b>
5/16"	12	L	M18x1.5	<b>28203181205</b>	<b>4,13</b>
3/8"	12	L	M18x1.5	<b>28203181206</b>	<b>3,67</b>
3/8"	15	L	M22x1.5	<b>28203221506</b>	<b>4,70</b>
1/2"	15	L	M22x1.5	<b>28203221508</b>	<b>5,01</b>
1/2"	18	L	M26x1.5	<b>28203261808</b>	<b>6,04</b>
5/8"	18	L	M26x1.5	<b>28203261810</b>	<b>6,41</b>
3/4"	22	L	M30x2	<b>28203302212</b>	<b>9,07</b>
1"	28	L	M36x2	<b>28203362816</b>	<b>15,83</b>
1"1/4	35	L	M45x2	<b>28203453520</b>	<b>30,02</b>
1"1/2	42	L	M52x2	<b>28203524224</b>	<b>45,70</b>
1/4"	8	S	M16x1.5	<b>28203160804</b>	<b>3,64</b>
1/4"	10	S	M18x1.5	<b>28203181004</b>	<b>4,21</b>
5/16"	10	S	M18x1.5	<b>28203181005</b>	<b>4,21</b>
3/8"	10	S	M18x1.5	<b>28203181006</b>	<b>4,35</b>
5/16"	12	S	M20x1.5	<b>28203201205</b>	<b>4,26</b>
3/8"	12	S	M20x1.5	<b>28203201206</b>	<b>4,43</b>
3/8"	14	S	M22x1.5	<b>28203221406</b>	<b>4,84</b>
1/2"	16	S	M24x1.5	<b>28203241608</b>	<b>5,70</b>
5/8"	20	S	M30x2	<b>28203302010</b>	<b>8,07</b>
3/4"	20	S	M30x2	<b>28203302012</b>	<b>9,85</b>
3/4"	25	S	M36x2	<b>28203362512</b>	<b>14,10</b>
1"	25	S	M36x2	<b>28203362516</b>	<b>16,02</b>
1"	30	S	M42x2	<b>28203423016</b>	<b>20,10</b>
1"1/4	38	S	M52x2	<b>28203523820</b>	<b>38,24</b>

# Conexiones Serie 43 una sola pieza 1SN / 2SN / R16 / 2SC / 3TE / R17

One piece fittings 43 Series 1SN / 2SN / R16 / 2SC / 3TE / R17

Embouts pré-sertis Série 43 1SN / 2SN / R16 / 2SC / 3TE / R17

Raccordi un pezzo Serie 43 1SN / 2SN / R16 / 2SC / 3TE / R17

## Hembras giratorias 90° una sola pieza Métricas cono 24° - DKO 90°

One piece Metric female cone 24° (90° Elbow)

Coude 90° femelle pré-sertie Métrique cono 24°

Femmina 90° compatta Metrica sede 24°

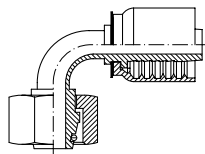

DN	PIPE TUBO	SERIE	THREAD ROSCA	Part nº Referencia	€
1/4"	6	L	M12x1.5	<b>28305120604</b>	<b>4,38</b>
1/4"	8	L	M14x1.5	<b>28305140804</b>	<b>4,42</b>
1/4"	10	L	M16x1.5	<b>28305161004</b>	<b>4,61</b>
5/16"	10	L	M16x1.5	<b>28305161005</b>	<b>4,87</b>
3/8"	10	L	M16x1.5	<b>28305161006</b>	<b>5,15</b>
5/16"	12	L	M18x1.5	<b>28305181205</b>	<b>5,52</b>
3/8"	12	L	M18x1.5	<b>28305181206</b>	<b>4,95</b>
3/8"	15	L	M22x1.5	<b>28305221506</b>	<b>7,16</b>
1/2"	15	L	M22x1.5	<b>28305221508</b>	<b>6,85</b>
5/8"	18	L	M26x1.5	<b>28305261810</b>	<b>10,52</b>
3/4"	22	L	M30x2	<b>28305302212</b>	<b>15,10</b>
1"	28	L	M36x2	<b>28305362816</b>	<b>22,78</b>
1 1/4"	35	L	M45x2	<b>28305453520</b>	<b>43,02</b>
1 1/2"	42	L	M52x2	<b>28305524224</b>	<b>71,31</b>
1/4"	8	S	M16x1.5	<b>28305160804</b>	<b>4,53</b>
1/4"	10	S	M18x1.5	<b>28305181004</b>	<b>4,59</b>
5/16"	10	S	M18x1.5	<b>28305181005</b>	<b>5,81</b>
5/16"	12	S	M20x1.5	<b>28305201205</b>	<b>6,35</b>
3/8"	12	S	M20x1.5	<b>28305201206</b>	<b>4,93</b>
3/8"	14	S	M22x1.5	<b>28305221406</b>	<b>7,44</b>
1/2"	16	S	M24x1.5	<b>28305241608</b>	<b>7,28</b>
5/8"	20	S	M30x2	<b>28305302010</b>	<b>11,60</b>
3/4"	20	S	M30x2	<b>28305302012</b>	<b>15,10</b>
3/4"	25	S	M36x2	<b>28305362512</b>	<b>18,28</b>
1"	25	S	M36x2	<b>28305362516</b>	<b>24,82</b>
1"	30	S	M42x2	<b>28305423016</b>	<b>29,74</b>
1 1/4"	38	S	M52x2	<b>28305523820</b>	<b>53,96</b>

## Hembras giratorias 45° una sola pieza Métricas cono 24° - DKO 45°

One piece Metric female cone 24° (45° Elbow)

Coude 45° femelle pré-sertie Métrique cono 24°

Femmina 45° compatta Metrica sede 24°

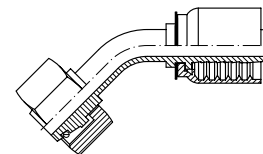

DN	PIPE TUBO	SERIE	THREAD ROSCA	Part nº Referencia	€
1/4"	6	L	M12x1.5	<b>28306120604</b>	<b>4,50</b>
1/4"	8	L	M14x1.5	<b>28306140804</b>	<b>4,49</b>
1/4"	10	L	M16x1.5	<b>28306161004</b>	<b>4,75</b>
5/16"	10	L	M16x1.5	<b>28306161005</b>	<b>4,88</b>
3/8"	10	L	M16x1.5	<b>28306161006</b>	<b>5,37</b>
5/16"	12	L	M18x1.5	<b>28306181205</b>	<b>6,04</b>
3/8"	12	L	M18x1.5	<b>28306181206</b>	<b>4,85</b>
1/2"	15	L	M22x1.5	<b>28306221508</b>	<b>7,53</b>
5/8"	18	L	M26x1.5	<b>28306261810</b>	<b>10,68</b>
3/4"	22	L	M30x2	<b>28306302212</b>	<b>14,85</b>
1"	28	L	M36x2	<b>28306362816</b>	<b>22,84</b>
1 1/4"	35	L	M45x2	<b>28306453520</b>	<b>45,14</b>
1 1/2"	42	L	M52x2	<b>28306524224</b>	<b>69,77</b>
1/4"	8	S	M16x1.5	<b>28306160804</b>	<b>5,27</b>
1/4"	10	S	M18x1.5	<b>28306181004</b>	<b>5,93</b>
5/16"	12	S	M20x1.5	<b>28306201205</b>	<b>6,70</b>
3/8"	12	S	M20x1.5	<b>28306201206</b>	<b>6,57</b>
3/8"	14	S	M22x1.5	<b>28306221406</b>	<b>7,44</b>
1/2"	16	S	M24x1.5	<b>28306241608</b>	<b>7,84</b>
5/8"	20	S	M30x2	<b>28306302010</b>	<b>12,64</b>
3/4"	20	S	M30x2	<b>28306302012</b>	<b>15,63</b>
3/4"	25	S	M36x2	<b>28306362512</b>	<b>20,04</b>
1"	25	S	M36x2	<b>28306362516</b>	<b>22,84</b>
1"	30	S	M42x2	<b>28306423016</b>	<b>27,97</b>
1 1/4"	38	S	M52x2	<b>28306523820</b>	<b>57,06</b>

## Orientable una sola pieza Métrico Recto

One piece Banjo metric

Banjo droit pré-serti Métrique

Raccordo ad occhio Metrico compatto

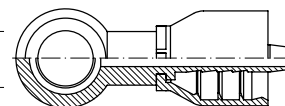

DN	Ø	Part nº Referencia	€
1/4"	M10x1	<b>281161004</b>	<b>4,20</b>
1/4"	M12x1.5	<b>281161204</b>	<b>4,51</b>
1/4"	M14x1.5	<b>281161404</b>	<b>4,51</b>
5/16"	M14x1.5	<b>281161405</b>	<b>5,03</b>
3/8"	M14x1.5	<b>281161406</b>	<b>5,39</b>
5/16"	M16x1.5	<b>281161605</b>	<b>5,37</b>
3/8"	M16x1.5	<b>281161606</b>	<b>5,30</b>
3/8"	M18x1.5	<b>281161806</b>	<b>6,40</b>
1/2"	M18x1.5	<b>281161808</b>	<b>6,90</b>
1/2"	M22x1.5	<b>281162208</b>	<b>9,20</b>
5/8"	M22x1.5	<b>281162210</b>	<b>8,33</b>
3/4"	M30x2	<b>281163012</b>	<b>15,28</b>

# Conexiones Serie 43 una sola pieza 1SN / 2SN / R16 / 2SC / 3TE / R17

One piece fittings 43 Series 1SN / 2SN / R16 / 2SC / 3TE / R17

Embouts pré-sertis Série 43 1SN / 2SN / R16 / 2SC / 3TE / R17

Raccordi un pezzo Serie 43 1SN / 2SN / R16 / 2SC / 3TE / R17

## Hembras giratorias una sola pieza Métricas cono 24°/60°

One piece Female metric swivel 24°/60° cone

Femelle tournante pré-sertie Métrique cône 24°-60°

Femmina Metrica Girevole Multiseal compatta 24°/60°

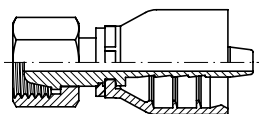

DN	PIPE TUBO	THREAD ROSCA	Part n° Referencia	€
1/4"	8L	M14X1.5	284049511	3,46
1/4"	10L	M16X1.5	284049520	3,79
5/16"	10L	M16X1.5	284049523	3,98
3/8"	10L	M16X1.5	284049524	4,53
5/16"	12L	M18X1.5	284049525	4,21
3/8"	12L	M18X1.5	284049535	4,39
3/8"	15L	M22X1.5	284049552	5,54
1/2"	15L	M22X1.5	284049555	6,45
5/8"	18L	M26X1.5	284049571	8,14

## Hembras giratorias 90° una sola pieza Métricas cono 24°/60°

One piece Female metric swivel 24°/60° cone (90° Elbow)

Femelle tournante coude 90° pré-sertie Métrique cône 24°-60°

Femmina Metrica Girevole a 90° Multiseal compatta 24°/60°

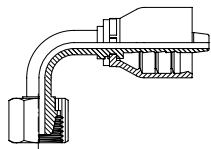

DN	PIPE TUBO	THREAD ROSCA	Part n° Referencia	€
1/4"	8L	M14X1.5	284059511	3,90
1/4"	10L	M16X1.5	284059520	4,22
5/16"	10L	M16X1.5	284059523	4,34
3/8"	10L	M16X1.5	284059524	5,17
5/16"	12L	M18X1.5	284059525	4,71
3/8"	12L	M18X1.5	284059535	4,77
3/8"	15L	M22X1.5	284059552	6,22
1/2"	15L	M22X1.5	284059555	7,43
5/8"	18L	M26X1.5	284059571	10,25

## Hembras giratorias 45° una sola pieza Métricas cono 24°/60°

One piece Female metric swivel 24°/60° cone (45° Elbow)

Femelle tournante coude 45° pré-sertie Métrique cône 24°-60°

Femmina Metrica Girevole a 45° Multiseal compatta 24°/60°

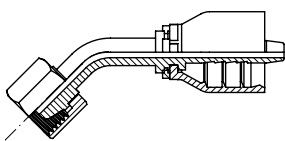

DN	PIPE TUBO	THREAD ROSCA	Part n° Referencia	€
1/4"	8L	M14X1.5	284069511	5,09
5/16"	10L	M16X1.5	284069523	5,54
3/8"	10L	M16X1.5	284069524	6,22
5/16"	12L	M18X1.5	284069525	6,16
3/8"	12L	M18X1.5	284069535	4,91
1/2"	15L	M22X1.5	284069555	8,50
5/8"	18L	M26X1.5	284069571	12,19

## Espiga lisa recta una sola pieza Métrica

One piece Metric standpipe

Embout lisse droit pré-serti Métrique

Estremità tubolare diritta Metrica compatta

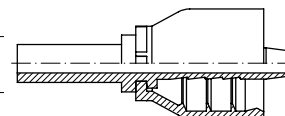

DN	PIPE TUBO	Part n° Referencia	€
1/4"	6	281580604	2,72
1/4"	8	281580804	2,75
5/16"	8	281580805	5,75
1/4"	10	281581004	2,84
5/16"	10	281581005	3,70
3/8"	10	281581006	3,36
1/4"	12	281581204	3,57
5/16"	12	281581205	3,69
3/8"	12	281581206	3,27
1/2"	12	281581208	7,32
3/8"	14	281581406	4,28
1/2"	14	281581408	5,35
3/8"	15	281581506	3,87
1/2"	15	281581508	4,50
1/2"	16	281581608	5,13
1/2"	18	281581808	4,62
5/8"	18	281581810	6,91
3/4"	20	281582012	8,98
3/4"	22	281582212	8,98
1"	25	281582516	14,72
1"	28	281582816	14,25
1"	30	281583016	14,37
1"1/4	35	281583520	29,44
1"1/2	42	281584224	40,70

## Hembras giratorias rectas una sola pieza Komatsu cono 60°

One piece Komatsu swivel female 60° cone

Femelle tournante droite Komatsu pré-serti Métrique (cône 60°)

Femmina Komatsu sede 60° compatta

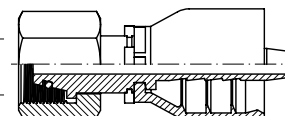

DN	THREAD ROSCA	Part n° Referencia	€
1/4"	M14X1.5	288049625	5,87
3/8"	M18X1.5	288049635	5,76
1/2"	M22X1.5	288049655	9,45
5/8"	M24X1.5	288049665	12,84
3/4"	M30X1.5	288049684	17,17
1"	M33X1.5	288049685	19,76

## Espigas de prensar dobles una sola pieza

One piece Double crimp standpipe

Embout double jonction pré-serti

Giunzione tubo-tubo compatta

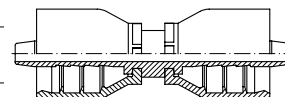

DN	Part n° Referencia	€
1/4"	283000404	3,10
5/16"	283000505	3,99
3/8"	283000606	4,13
1/2"	283000808	4,97
3/4"	283001212	12,73
1"	283001616	19,59

# Conexiones Serie 43 una sola pieza 1SN / 2SN / R16 / 2SC / 3TE / R17

One piece fittings 43 Series 1SN / 2SN / R16 / 2SC / 3TE / R17  
 Embouts pré-sertis Série 43 1SN / 2SN / R16 / 2SC / 3TE / R17  
 Raccordi un pezzo Serie 43 1SN / 2SN / R16 / 2SC / 3TE / R17

## Hembras giratorias rectas una sola pieza rosca BSP cono 60°

One piece BSP female 60° cone

Femelle pré-sertie BSP cone 60°

Femmina diritta compatta BSP sede 60°

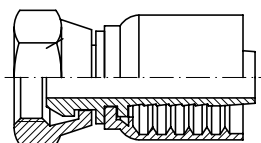

DN	THREAD ROSCA	Part nº Referencia	€
1/4"	1/8" BSP	281000204	3,46
3/16"	1/4" BSP	281000403	3,49
1/4"	1/4" BSP	281000404	3,15
5/16"	1/4" BSP	281000405	3,76
3/8"	1/4" BSP	281000406	4,25
1/4"	3/8" BSP	281000604	3,80
5/16"	3/8" BSP	281000605	3,89
3/8"	3/8" BSP	281000606	3,83
1/2"	3/8" BSP	281000608	4,82
1/4"	1/2" BSP	281000804	4,45
3/8"	1/2" BSP	281000806	4,52
1/2"	1/2" BSP	281000808	4,94
5/8"	1/2" BSP	281000810	6,89
1/2"	5/8" BSP	281001008	6,29
5/8"	5/8" BSP	281001010	6,74
1/2"	3/4" BSP	281001208	6,93
3/4"	3/4" BSP	281001212	8,54
3/4"	1" BSP	281001612	11,58
1"	1" BSP	281001616	13,09

## Hembras giratorias rectas una sola pieza rosca BSP cono 60° doble hexagonal

One piece double hexagonal BSP female 60° cone

Femelle pré-sertie BSP cone 60° double hexagonal

Femmina diritta compatta BSP sede 60° doppio esagono

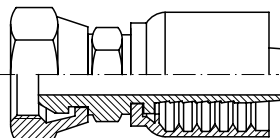

DN	THREAD ROSCA	Part nº Referencia	€
1/4"	1/4" BSP	284000404	4,33
5/16"	3/8" BSP	284000605	4,90
3/8"	3/8" BSP	284000606	5,17
1/2"	1/2" BSP	284000808	6,37
3/4"	3/4" BSP	284001212	12,16
1"	1" BSP	284001616	16,48
1"1/4"	1"1/4" BSP	284002020	38,82
1"1/2"	1"1/2" BSP	284002424	57,84
2"	2" BSP	284003232	96,07

## Hembras giratorias 90° una sola pieza BSP cono 60° (compactas)

One piece BSP Swivel female 60° cone compact (90° Elbow)

Coude 90° femelle tournante pré-serti compact gaz cyl BSP 60°

Femmina a 90° compatta BSP sede 60° (compatta)

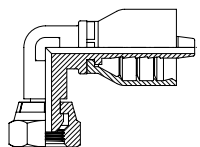

DN	THREAD ROSCA	Part nº Referencia	€
1/4"	1/4" BSP	281270404	5,76
3/8"	3/8" BSP	281270606	7,02
1/2"	1/2" BSP	281270808	8,76
3/4"	3/4" BSP	281271212	14,76

## Hembras giratorias 90° una sola pieza rosca BSP cono 60°

One piece BSP female cone 60° (90° Elbow)

Coude 90° femelle pré-sertie BSP cone 60°

Femmina 90° compatta BSP sede 60°

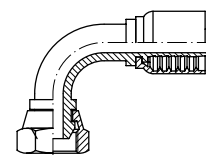

DN	THREAD ROSCA	Part nº Referencia	€
1/4"	1/8" BSP	281070204	3,90
1/4"	1/4" BSP	281070404	4,04
1/4"	3/8" BSP	281070604	4,88
5/16"	3/8" BSP	281070605	5,42
3/8"	3/8" BSP	281070606	4,96
1/4"	1/2" BSP	281070804	6,73
3/8"	1/2" BSP	281070806	5,86
1/2"	1/2" BSP	281070808	6,28
1/2"	5/8" BSP	281071008	10,15
5/8"	5/8" BSP	281071010	10,13
1/2"	3/4" BSP	281071208	10,10
3/4"	5/8" BSP	281071210	10,78
3/4"	3/4" BSP	281071212	11,68
1"	3/4" BSP	281071612	17,55
1"	1" BSP	281071616	19,76

## Hembras giratorias 45° una sola pieza rosca BSP cono 60°

One piece BSP female 60° cone (45° Elbow)

Coude 45° femelle pré-sertie BSP cone 60°

Femmina 45° compatta BSP sede 60°

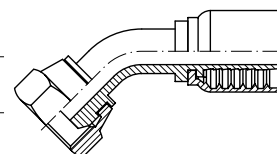

DN	THREAD ROSCA	Part nº Referencia	€
1/4"	1/8" BSP	281080204	3,93
1/4"	1/4" BSP	281080404	4,08
1/4"	3/8" BSP	281080604	5,39
5/16"	3/8" BSP	281080605	5,42
3/8"	3/8" BSP	281080606	5,31
3/8"	1/2" BSP	281080806	6,47
1/2"	1/2" BSP	281080808	7,21
1/2"	5/8" BSP	281081008	9,46
5/8"	5/8" BSP	281081010	10,28
5/8"	3/4" BSP	281081210	11,69
3/4"	3/4" BSP	281081212	13,19
3/4"	1" BSP	281081612	19,15
1"	1" BSP	281081616	19,86

# Conexiones Serie 43 una sola pieza 1SN / 2SN / R16 / 2SC / 3TE / R17

One piece fittings 43 Series 1SN / 2SN / R16 / 2SC / 3TE / R17

Embouts pré-sertis Série 43 1SN / 2SN / R16 / 2SC / 3TE / R17

Raccordi un pezzo Serie 43 1SN / 2SN / R16 / 2SC / 3TE / R17

## Hembras giratorias rectas una sola pieza rosca BSP cono 60° con junta tórica

One piece BSP female 60° cone +o'ring

Femelle pré-sertie BSP cone 60° + o'ring

Femmina diritta compatta BSP sede 60° + o'ring

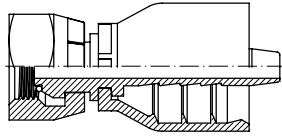

DN	THREAD ROSCA	Part nº Referencia	€
1/4"	1/4" BSP	281100404	3,76
3/8"	3/8" BSP	281100606	4,31
1/2"	1/2" BSP	281100808	5,84
5/8"	5/8" BSP	281101010	8,54
5/8"	3/4" BSP	281101210	8,16
3/4"	3/4" BSP	281101212	8,66
1"	1" BSP	281101616	15,52
1"	1" 1/4 BSP	281102016	22,47
1" 1/4	1" 1/2 BSP	281102420	38,50
1" 1/2	2" BSP	281103224	63,57
1" 1/4	1" 1/4 BSP	281102020	33,14
1" 1/2	1" 1/2 BSP	281102424	45,59
2"	2" BSP	281103232	78,75

## Hembras giratorias 90° una sola pieza rosca BSP cono 60° con junta tórica

One piece BSP female cone 60° (90° Elbow) +o'ring

Coude 90° femelle pré-sertie BSP cone 60° +o'ring

Femmina 90° compatta BSP sede 60° + o'ring

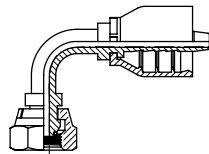

DN	THREAD ROSCA	Part nº Referencia	€
1/4"	1/4" BSP	281170404	5,22
3/8"	3/8" BSP	281170606	6,51
1/2"	1/2" BSP	281170808	8,77
5/8"	5/8" BSP	281171010	11,65
3/4"	3/4" BSP	281171212	14,34
1"	1" BSP	281171616	23,71
1"	1" 1/4 BSP	281172016	33,36
1" 1/4	1" 1/4 BSP	281172020	47,99
1" 1/4	1" 1/2 BSP	281172420	63,41
1" 1/2	1" 1/2 BSP	281172424	60,42
2"	2" BSP	281173232	126,60

## Hembras giratorias 45° una sola pieza rosca BSP cono 60° con junta tórica

One piece BSP female 60° cone (45° Elbow) +o'ring

Coude 45° femelle pré-sertie BSP cone 60° +o'ring

Femmina 45° compatta BSP sede 60° + o'ring

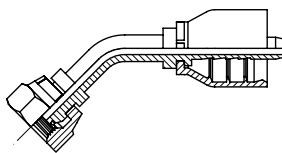

DN	THREAD ROSCA	Part nº Referencia	€
3/8"	3/8" BSP	281180606	5,34
1/2"	1/2" BSP	281180808	6,75
5/8"	5/8" BSP	281181010	11,65
3/4"	3/4" BSP	281181212	17,82
1"	1" BSP	281181616	21,17
1" 1/4	1" 1/4 BSP	281182020	37,67
1" 1/2	1" 1/2 BSP	281182424	53,00
2"	2" BSP	281183232	86,43

## Hembras giratorias rectas una sola pieza BSP asiento plano

One piece BSP Swivel female flat seat

Femelle pré-sertie tournante fond plat BSP

Femmina diritta compatta BSP sede piana

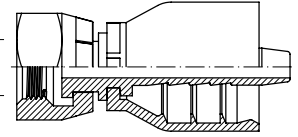

DN	THREAD ROSCA	Part nº Referencia	€
1/4"	1/4" BSP	282000404	3,58
5/16"	3/8" BSP	282000605	4,45
3/8"	3/8" BSP	282000606	4,51
3/8"	1/2" BSP	282000806	5,39
1/2"	1/2" BSP	282000808	5,89
1/2"	3/4" BSP	282001208	7,37
3/4"	3/4" BSP	282001212	9,53
1"	1" BSP	282001616	14,46
1" 1/4	1" 1/4 BSP	282002020	34,35
1" 1/2	1" 1/2 BSP	282002424	47,39

## Hembras giratorias 90° una sola pieza BSP asiento plano

One piece BSP Swivel female flat seat (90° Elbow)

Embout pré-serti coude 90° femelle tournante fond plat BSP

Femmina a 90° compatta BSP sede 60° sede piana

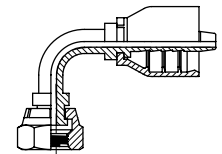

DN	THREAD ROSCA	Part nº Referencia	€
1/4"	1/4" BSP	282070404	4,71
3/8"	3/8" BSP	282070606	6,04
1/2"	1/2" BSP	282070808	7,17
3/4"	3/4" BSP	282071212	14,73
1"	1" BSP	282071616	24,64

## Macho rosca cilíndrica BSP una sola pieza asiento plano

One piece BSP Male flat seat

Mâle pré-serti fixe gaz cyl fond plat

Maschio BSP compatto cilindrico sede piana

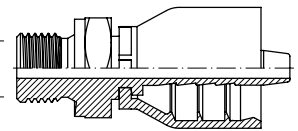

DN	THREAD ROSCA	Part nº Referencia	€
1/4"	1/4" BSP	282120404	4,33
3/8"	3/8" BSP	282120606	5,42
3/8"	1/2" BSP	282120806	6,75
1/2"	1/2" BSP	282120808	7,05
3/4"	3/4" BSP	282121212	11,13
1"	1" BSP	282121616	18,61

# Conexiones Serie 43 una sola pieza 1SN / 2SN / R16 / 2SC / 3TE / R17

One piece fittings 43 Series 1SN / 2SN / R16 / 2SC / 3TE / R17

Embouts pré-serti Série 43 1SN / 2SN / R16 / 2SC / 3TE / R17

Raccordi un pezzo Serie 43 1SN / 2SN / R16 / 2SC / 3TE / R17

## Machos una sola pieza rosca cilíndrica BSP cono 60°

One piece BSP male 60° cone

Mâle pré-serti BSP cone 60°

Maschio compatto cilindrico BSP sede 60°

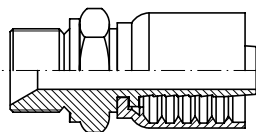

DN	THREAD ROSCA	Part n° Referencia	€
1/4"	1/8" BSP	281120204	3,41
1/4"	1/4" BSP	281120404	3,24
3/8"	1/4" BSP	281120406	4,44
1/4"	3/8" BSP	281120604	3,94
5/16"	3/8" BSP	281120605	4,16
3/8"	3/8" BSP	281120606	3,98
1/2"	3/8" BSP	281120608	5,20
1/4"	1/2" BSP	281120804	4,75
3/8"	1/2" BSP	281120806	4,67
1/2"	1/2" BSP	281120808	5,17
1/2"	5/8" BSP	281121008	7,82
5/8"	5/8" BSP	281121010	7,59
1/2"	3/4" BSP	281121208	7,70
5/8"	3/4" BSP	281121210	8,54
3/4"	3/4" BSP	281121212	8,79
3/4"	1" BSP	281121612	14,30
1"	1" BSP	281121616	13,47
1"	1"1/4 BSP	281122016	25,57
1"1/4"	1"1/4 BSP	281122020	34,91
1"1/2"	1"1/2 BSP	281122424	43,71
2"	2" BSP	281123232	87,54

## Macho rosca cónica una sola pieza BSPT

One piece BSPT Male tapered

Mâle pré-serti fixe gaz conique BSPT

Maschio BSPT compatto conico

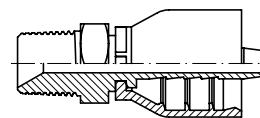

DN	THREAD ROSCA	Part n° Referencia	€
1/4"	1/8" BSPT	281140204	2,97
1/4"	1/4" BSPT	281140404	2,97
1/4"	3/8" BSPT	281140604	3,67
5/16"	3/8" BSPT	281140605	3,92
3/8"	3/8" BSPT	281140606	3,85
3/8"	1/2" BSPT	281140806	4,43
1/2"	1/2" BSPT	281140808	5,02
5/8"	3/4" BSPT	281141210	7,50
3/4"	3/4" BSPT	281141212	9,01
3/4"	1" BSPT	281141612	12,71
1"	1" BSPT	281141616	15,39
1"	1"1/4 BSPT	281142016	21,19
1"1/4"	1"1/4 BSPT	281142020	33,56
1"1/2"	1"1/2 BSPT	281142424	40,54
2"	2" BSPT	281143232	81,25

## Orientable una sola pieza BSP

One piece Banjo BSP

Embout pré-serti Banjo droit gaz

Raccordo ad occhio compatto BSP

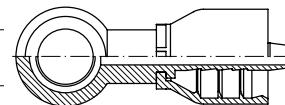

DN	THREAD ROSCA	Part n° Referencia	€
1/4"	1/4" BSP	281110404	4,22
5/16"	1/4" BSP	281110405	5,01
3/8"	1/4" BSP	281110406	5,07
1/4"	3/8" BSP	281110604	5,43
5/16"	3/8" BSP	281110605	5,96
3/8"	3/8" BSP	281110606	5,22
1/2"	3/8" BSP	281110608	6,11
3/8"	1/2" BSP	281110806	7,21
1/2"	1/2" BSP	281110808	7,75
5/8"	5/8" BSP	281111010	14,02
1/2"	3/4" BSP	281111208	14,00
5/8"	3/4" BSP	281111210	15,96
3/4"	3/4" BSP	281111212	16,90
1"	1" BSP	281111616	33,56

## Configura tus propias conexiones en *Una sola pieza. Consúltanos.*

Configure your own one piece series fittings. Consult us.

Configurez vos propres connexions en une seule pièce. Sur demande

Configura la tua combinazione personalizzata in prezzo unico. Su richiesta

### ■ Conexiones Una sola pieza Serie 43

One piece fittings 43 Series  
Embouts pré-sertis Série 43  
Prezzo unico Serie 43



### ■ Conexiones Una sola pieza Serie Standard

3SP/4SP/4SH/R12

One piece fittings Standard Serie  
Embouts pré-sertis pour Standard  
Prezzo unico serie Standard

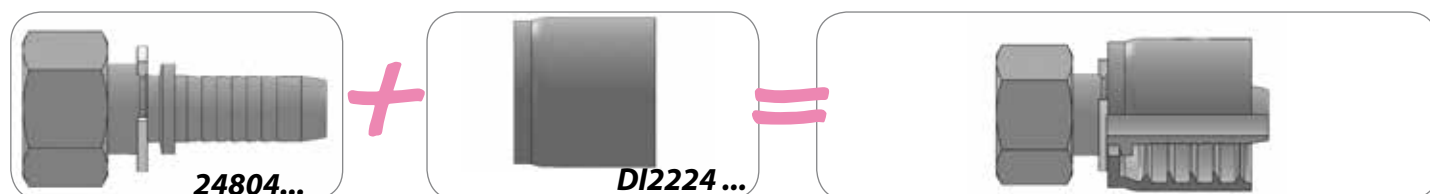

### ■ Conexiones Una sola pieza R7 / R8 y elastómero malla metálica

Piece fittings R7 / R8 & braid of steel wire  
Embouts pré-sertis R7 / R8 et tresse métallique  
Prezzo unico serie R7 / R8 e elastomero treccia metallica



### ■ Conexiones Una sola pieza PTFE liso

One piece fittings for smooth PTFE  
Embouts pré-sertis pour PTFE lisse  
Prezzo unico serie PTFE liscio

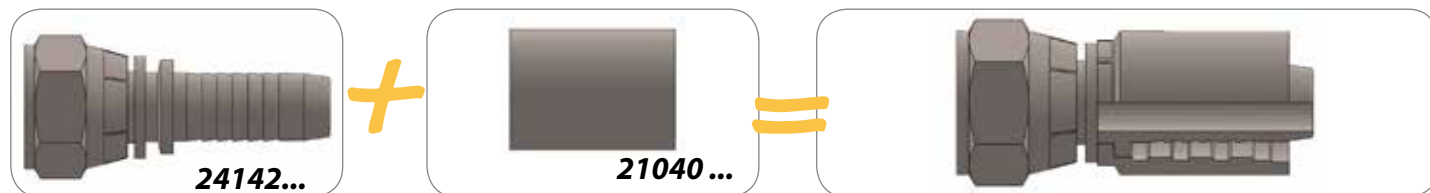

### ■ Conexiones Una sola pieza PTFE corrugado

One piece fittings for convoluted PTFE  
Embouts pré-sertis pour PTFE convolute  
Prezzo unico serie PTFE convoluto



# Conexiones Serie BW una sola pieza R12 / 4SP / 4SH

One piece fittings BW series R12 / 4SP / 4SH

Embouts pré-sertis Série BW R12 / 4SP / 4SH

Raccordi BW - 1 pezzo R12 / 4SP / 4SH

## Macho JIC 37°

JIC 37° male

Mâle JIC 37°

Maschio JIC 37°

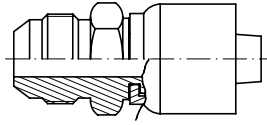

DN	THREAD ROSCA	Part nº Referencia	€
3/4"	1"1/16 12h UNF	<b>681401712</b>	<b>16,54</b>
1"	1"5/16 12h UNF	<b>681402116</b>	<b>23,67</b>

## Hembras giratorias rectas JIC 37° doble hexagono

JIC 37° swivel female

Femelle JIC 37°

Femmina diritta JIC 37°

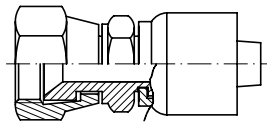

DN	THREAD ROSCA	Part nº Referencia	€
3/4"	1"1/16 12h UNF	<b>682421712</b>	<b>18,68</b>
1"	1"5/16 12h UNF	<b>682422116</b>	<b>26,23</b>

## Hembra giratoria recta ORFS asiento plano doble hexagono

ORFS Swivel female straight

Femelle droite ORFS

Femmina diritta ORFS

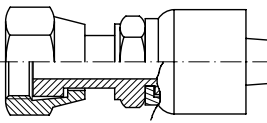

PIPE TUBO	THREAD ROSCA	Part nº Referencia	€
3/4"	1"3/16 12h UNF	<b>689011212</b>	<b>19,65</b>
1"	1"7/16 12h UNF	<b>689011616</b>	<b>26,73</b>

## Hembra giratoria 90° ORFS asiento plano

ORFS Swivel female (90° Elbow)

CoUDE 90° femelle ORFS

Femmina 90° ORFS

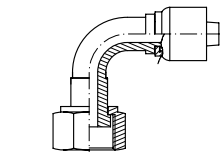

PIPE TUBO	THREAD ROSCA	Part nº Referencia	€
3/4"	1"3/16 12h UNF	<b>689071212</b>	<b>25,57</b>
1"	1"7/16 12h UNF	<b>689071616</b>	<b>36,05</b>

## Hembras giratorias 90° JIC 37°

JIC 37° swivel female (90° Elbow)

CoUDE 90° femelle JIC 37°

Femmina gir. 90° JIC 37°

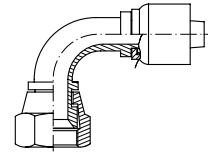

DN	THREAD ROSCA	Part nº Referencia	€
3/4"	1"1/16 12h UNF	<b>681381712</b>	<b>24,29</b>
1"	1"5/16 12h UNF	<b>681382116</b>	<b>32,40</b>

## Hembras giratorias 45° JIC 37°

JIC 37° swivel female (45° Elbow)

CoUDE 45° femelle JIC 37°

Femmina gir. 45° JIC 37°

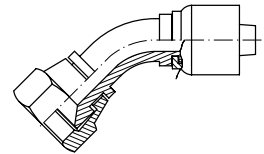

DN	THREAD ROSCA	Part nº Referencia	€
3/4"	1"1/16 12h UNF	<b>681391712</b>	<b>23,07</b>
1"	1"5/16 12h UNF	<b>681392116</b>	<b>32,40</b>

## Hembra giratoria 45° ORFS asiento plano

ORFS Swivel female (45° Elbow)

CoUDE 45° femelle ORFS

Femmina 45° ORFS

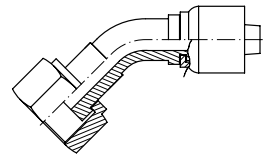

PIPE TUBO	THREAD ROSCA	Part nº Referencia	€
3/4"	1"3/16 12h UNF	<b>689081212</b>	<b>23,62</b>
1"	1"7/16 12h UNF	<b>689081616</b>	<b>32,40</b>

# Conexiones Serie BW una sola pieza R12 / 4SP / 4SH

One piece fittings BW series R12 / 4SP / 4SH

Embouts pré-sertis Série BW R12 / 4SP / 4SH

Raccordi BW - 1 pezzo R12 / 4SP / 4SH

Hoses

Flexible hose fittings

Flow measuring

Equipment for flexible hoses

## Brida recta SAE 3000 PSI

One piece 3000 PSI SAE Straight Flange/ Code 61

Bride SAE droite série 3000 PSI

Flangia diritta SAE 3000

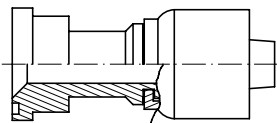

DN	Ø	Part nº Referencia	€
3/4"	38.1	<b>681821212</b>	<b>22,33</b>
1"	44.5	<b>681821616</b>	<b>28,91</b>
1"1/4	50.8	<b>681822020</b>	<b>47,98</b>

## Brida recta SAE 6000 PSI

One piece 6000 PSI SAE Straight Flange/ Code 62

Bride SAE droite série 6000 PSI

Flangia diritta SAE 6000

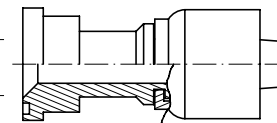

DN	Ø	Part nº Referencia	€
3/4"	41,3	<b>682821212</b>	<b>23,68</b>
1"	47,63	<b>682821616</b>	<b>30,50</b>
1"1/4	53,98	<b>682822020</b>	<b>50,05</b>

## Brida a 90° SAE 3000 PSI

One piece 3000 PSI SAE Flange (90° Elbow)/ Code 61

Bride SAE coude 90° série 3000 PSI

Flangia 90° SAE 3000

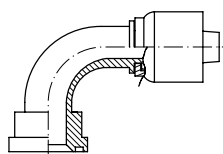

DN	Ø	Part nº Referencia	€
3/4"	38.1	<b>681831212</b>	<b>28,13</b>
1"	44.5	<b>681831616</b>	<b>35,38</b>
1"1/4	50.8	<b>681832020</b>	<b>59,36</b>

## Brida a 90° SAE 6000 PSI

One piece 6000 PSI SAE Flange (90° Elbow)/ Code 62

Bride SAE coude 90° série 6000 PSI

Flangia 90° SAE 6000

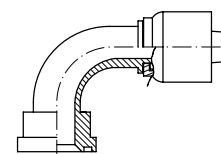

DN	Ø	Part nº Referencia	€
3/4"	41.3	<b>682831212</b>	<b>29,78</b>
1"	47.6	<b>682831616</b>	<b>39,40</b>
1"1/4	54	<b>682832020</b>	<b>65,59</b>

## Brida a 45° SAE 3000 PSI

One piece 3000 PSI SAE Flange (45° Elbow)/ Code 61

Bride SAE coude 45° série 3000 PSI

Flangia 45° SAE 3000

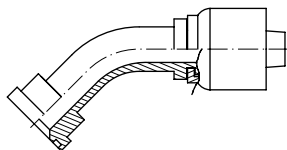

DN	Ø	Part nº Referencia	€
3/4"	38.1	<b>681841212</b>	<b>28,13</b>
1"	44.5	<b>681841616</b>	<b>36,96</b>
1"1/4	50.8	<b>681842020</b>	<b>59,36</b>

## Brida a 45° SAE 6000 PSI

One piece 6000 PSI SAE Flange (45° Elbow)/ Code 62

Bride SAE coude 45° série 6000 PSI

Flangia 45° SAE 6000

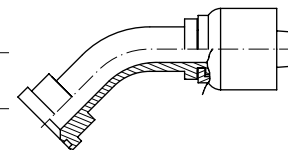

DN	Ø	Part nº Referencia	€
3/4"	41,3	<b>682841212</b>	<b>29,78</b>
1"	47,6	<b>682841616</b>	<b>39,40</b>
1"1/4	54	<b>682842020</b>	<b>66,01</b>

# Conexiones Serie BW una sola pieza R12 / 4SP / 4SH

One piece fittings BW series R12 / 4SP / 4SH

Embouts pré-sertis Série BW R12 / 4SP / 4SH

Raccordi BW - 1 pezzo R12 / 4SP / 4SH

## Hembras giratorias Métricas cono 24° con junta tórica

Metric swivel female 24° seat with o'ring

Femelle Métrique 24° avec o'ring

Femmina Metrica sede 24° con o'ring

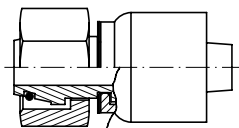

DN	THREAD ROSCA	Part n° Referencia	€
3/4"	M36X2	<b>68204362512</b>	<b>22,46</b>
1"	M42X2	<b>68204423016</b>	<b>32,43</b>
1"1/4	M52X2	<b>68204523820</b>	<b>46,84</b>

## Hembras giratorias 45° Métricas cono 24° con junta tórica

Metric swivel female 24° seat with o'ring (45° Elbow)

Coude 45° femelle Métrique 24° avec o'ring

Femmina Metrica 45° sede 24° con o'ring

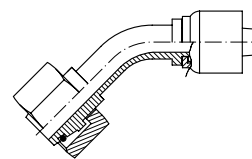

DN	THREAD ROSCA	Part n° Referencia	€
3/4"	M36X2	<b>68206362512</b>	<b>27,03</b>
1"	M42X2	<b>68206423016</b>	<b>35,53</b>
1"1/4	M52X2	<b>68206523820</b>	<b>64,34</b>

## Hembras giratorias 90° Métricas cono 24° con junta tórica

Metric swivel female 24° seat with o'ring (90° Elbow)

Coude 90° femelle Métrique 24° avec o'ring

Femmina Metrica 90° sede 24° con o'ring

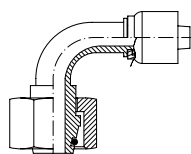

DN	THREAD ROSCA	Part n° Referencia	€
3/4"	M36X2	<b>68205362512</b>	<b>28,16</b>
1"	M42X2	<b>68205423016</b>	<b>38,66</b>
1"1/4	M52X2	<b>68205523820</b>	<b>64,34</b>

## Machos fijos Métricos cono 24°

Metric male stud 24° cone

Mâle Métrique cone 24°

Maschio Metrico sede 24°

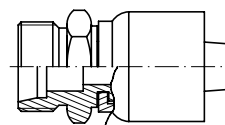

DN	THREAD ROSCA	Part n° Referencia	€
3/4"	M36X2	<b>68203362512</b>	<b>21,10</b>
1"	M42X2	<b>68203423016</b>	<b>28,23</b>

## Hembras giratorias rectas BSP cono 60°

BSP Swivel female 60° cone

Femelle tournante gaz cyl BSP 60°

Femmina diritta BSP sede 60°

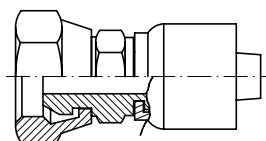

DN	THREAD ROSCA	Part n° Referencia	€
3/4"	3/4" BSP	<b>681101212</b>	<b>17,02</b>
1"	1" BSP	<b>681101616</b>	<b>23,55</b>
1"1/4	1"1/4 BSP	<b>681102020</b>	<b>41,43</b>

## Hembras giratorias 45° BSP cono 60°

BSP Swivel female 60° cone (45° Elbow)

Hembras giratorias 45° BSP cono 60°

Femmina a 45° BSP sede 60°

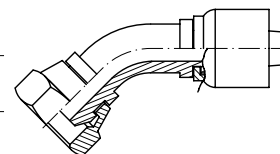

DN	THREAD ROSCA	Part n° Referencia	€
3/4"	3/4" BSP	<b>681081212</b>	<b>22,92</b>
1"	1" BSP	<b>681081616</b>	<b>32,40</b>
1"1/4	1"1/4 BSP	<b>681082020</b>	<b>56,70</b>

## Hembras giratorias 90° BSP cono 60°

BSP Swivel female 60° cone (90° Elbow)

Coude 90° femelle tournante gaz cyl BSP 60°

Femmina a 90° BSP sede 60°

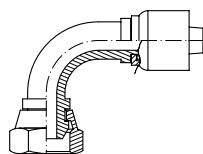

DN	THREAD ROSCA	Part n° Referencia	€
3/4"	3/4" BSP	<b>681071212</b>	<b>22,88</b>
1"	1" BSP	<b>681071616</b>	<b>31,47</b>
1"1/4	1"1/4 BSP	<b>681072020</b>	<b>53,83</b>

## Macho BSP cono 60°

BSP Male 60°

Mâle gaz cylindrique BSP 60°

Maschio BSP cilindrico sede 60°

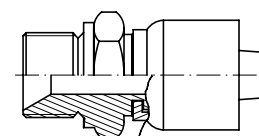

DN	THREAD ROSCA	Part n° Referencia	€
3/4"	3/4" BSP	<b>681121212</b>	<b>17,91</b>
1"	1" BSP	<b>681121616</b>	<b>24,59</b>
1"1/4	1"1/4 BSP	<b>681122020</b>	<b>42,19</b>

# INFINITAS SOLUCIONES PARA CONEXIONES DE MANGUERAS:

INFINITE SOLUTIONS FOR CONNECTING HOSES:

■ **Diversos diseños para cumplir las necesidades de conexión**  
*Several designed connections focused on the specific different requirements*

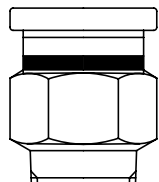
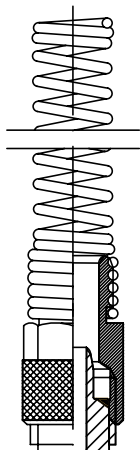
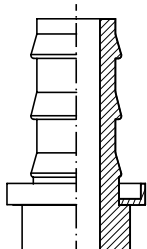
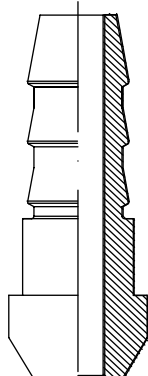
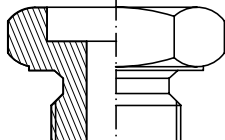
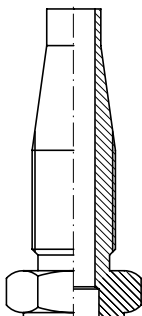
					
PUSH-IN NEUMÁTICO	PUSH-ON NEUMÁTICO	PUSH-ON HIDRÁULICO	BAJA PRESIÓN	SOLDABLE	REUSABLE
NEUMATIC PUSH-IN	NEUMATIC PUSH-ON	HYDRAULIC PUSH-ON	LOW PRESSURE	WELDING	REUSABLE
★	★	★★	★★	★★	★★★

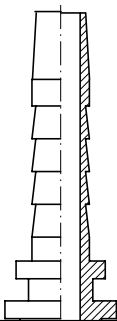
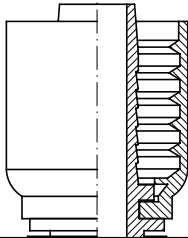
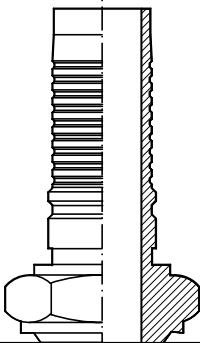
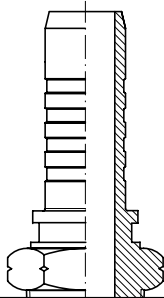
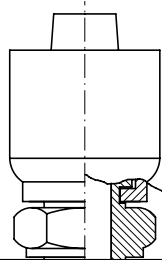
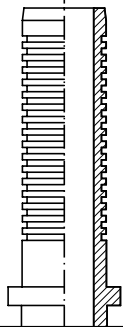
					
ESTÁNDAR	UNA SOLA PIEZA 43 (COMPACTA)	INTERLOCK	BW NO PELAR	UNA SOLA PIEZA BW (COMPACTA)	ALTA PRESIÓN (700BAR)
STANDARD	ONE-PIECE 43 (COMPACT)	INTERLOCK	BW NO SKIVE	ONE PIECE BW (COMPACT)	HIGH PRESSURE (700BAR)
★★★★★		★★★★★★		★★★★★★★	★★★★★★★

Hoses

Flexible hose fittings

Flow measuring

Equipment for flexible hoses

## Metrología

*Flow measuring*

Test du circuit hydraulique

*Test per circuiti idraulici*

### Conexiones Serie Micro-hose

*Micro-hose fittings*

Embouts manomètres

*Raccordi per micro-tubi*

98

### Racores de control

*Test couplings*

Prises de pression

*Prese di pressione*

100

### Instrumentos de medición

*Pressure and vacuum gauges*

Manomètres et vacuomètres

*Manometri e vacuometri*

103

### Medidores de caudal

*Flow tester*

Débitmètres

*Indicatori di flusso*

107

3

# Conexiones Serie Micro-hose

Micro-hose fittings  
 Embouts manomètres  
 Raccordi per micro-tubi

- Mangueras para tomas de manómetro / Hoses for check couplings for manometers / Tuyaux capillaires minimes / Tubi per prese di pressione

98



MT010

- Conexiones / Crimp fittings / Embouts à sertir minimes / Raccordi a pressare

98

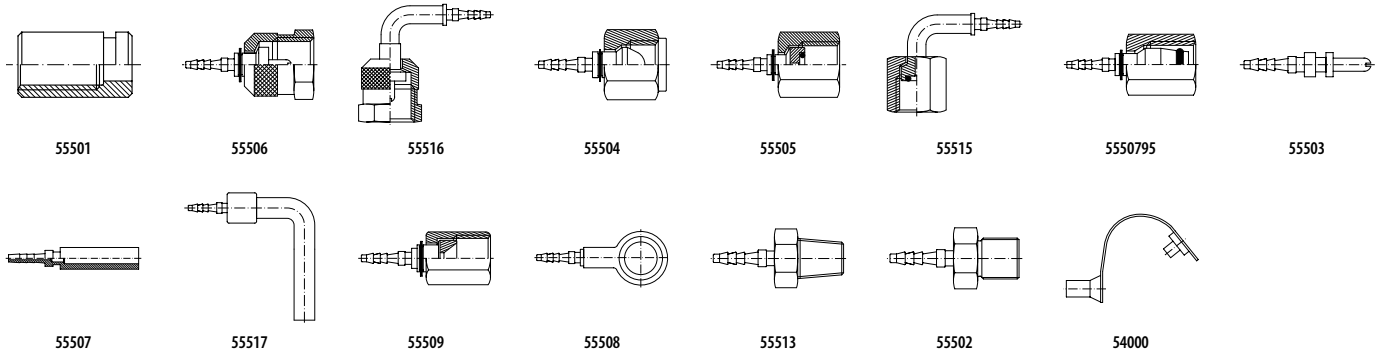

# Racores de control

Test couplings  
Prises de pression  
Prese di pressione

- Tomas de presión 16x1.5 / Check couplings for manometers 16x1.5 / Prises de pression 16x1.5 / Prese di pressione 16x1.5 | 100

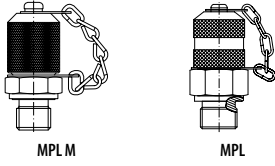

MPLM

MPL

- Tomas de presión 16x2 / Check couplings for manometers 16x2 / Prises de pression 16x2 / Prese di pressione 16x2 | 100

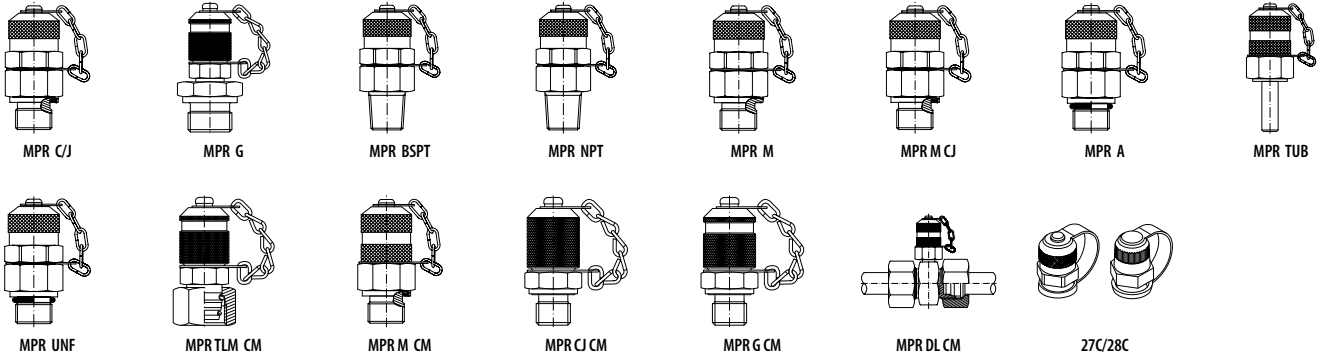

MPR C/J

MPR G

MPR BSPT

MPR NPT

MPR M

MPR M CJ

MPR A

MPR TUB

MPR UNF

MPR TLM CM

MPR M CM

MPR CJ CM

MPR G CM

MPR DL CM

27C/28C

- Tomas de presión manómetros / Accessoires and adaptors / Accessoires et adaptateurs minimess / Accessori e adattatori | 102

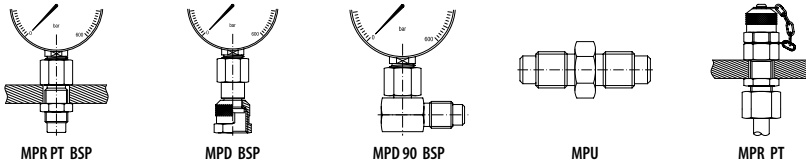

MPR PT BSP

MPD BSP

MPD 90 BSP

MPU

MPR PT

- Válvulas para manómetros / Valves for manometers / Valves pour manètres / Valvole per manometri | 102



FT290

FT291

FT299

# Instrumentos de medición

*Pressure and vacuum gauges*  
*Manomètres et vacuomètres*  
*Manometri e vacuometri*

## Manómetros / Pressure gauges / Manomètres / Manometri

| 103



MFI63...V



MFI63...-DB



MFI100...V



MFI100...-DB



MFI63...-DBSB



MFI63...-DBCA



ABRMFI



MFI63...V NPT



MFI63...-DB NPT



MFI100...V NPT



MFI CO



MANDIG63



MANDIG100

## Vacuómetros / Vacuum gauges / Vacuomètres / Vacuometri

| 105



VAC6304



MFIVA

## Termomanómetros / Temperature- pressure gauge / Thermo-manomètre / Termomanometri

| 105



MFIT63...V



MFIT63..DB

## Manovacuómetros / Manovacuumeter / Manovacuumètre / Manovacuumetri

| 105



MFIVAC63...V



MFIVAC63...DB

## Maletines de control de presión / Check cases / Équipes de mesure / Valigetta per rilevamento di pressione

| 106



CBOXMED F



CBOX0001



CBOX0003



CBOX0002

# Medidores de caudal

Flow tester  
Débitmètres  
Indicatori di flusso

- Caudalímetros 250 bar / Flow tester 250 bar / Débitmètres 250 bar / Flussostati 250 bar

| 107



WPB3A6H



WPB5A6H



WPB6A6H

- Caudalímetros 300-420 bar / Flow tester 300-420 bar / Débitmètres 300-420 bar / Flussostati 300-420 bar

| 107



FT5758



FT6068



FT5594

# Conexiones Serie Micro-hose

Micro-hose fittings  
Embouts manomètres  
Raccordi per micro-tubi

## Mangueras Minimess

"Micro-Hose" hose

Tuyaux Minimess



Micro-tubo per presa di pressione

Ø INNER Ø INT.	Part n° Referencia	€
2	<b>MT01002</b>	<b>3,43</b>

## Casquillo manguera Minimess

Micro-hose ferrules

Jupe pour tuyau Minimess

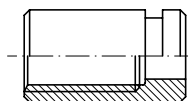

Boccola per Micro-tubo

DN	Ø OUTER Ø EXT.	Ø INNER Ø INT.	Part n° Referencia	€
2	8	5.1	<b>555010100</b>	<b>0,44</b>

## Hembra giratoria de control

Check Metric swivel female Micro-hose

Embout femelle tournante de control Métrique  
Minimess

Presca di pressione femmina

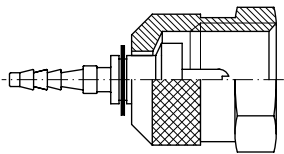

DN	THREAD ROSCA	Part n° Referencia	€
2	M16X1.5	<b>555069521</b>	<b>4,57</b>
2	M16X2	<b>555069523</b>	<b>4,81</b>

## Codo 90° hembra giratoria de control

90° Swivel female check coupling

Coude 90° prise de pression femelle tournante

Presca di pressione femmina 90° girevole

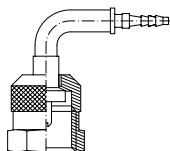

DN	THREAD ROSCA	Part n° Referencia	€
2	M16X2	<b>555169523</b>	<b>35,56</b>

## Hembra giratoria recta BSP

Straight swivel female BSP 60° cone Micro-hose

Embout femelle tournante gaz cyl BSP 60°  
Minimess

Femmina girevole BSP

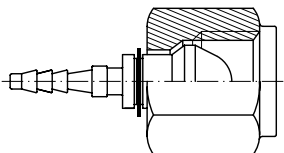

DN	THREAD ROSCA	Part n° Referencia	€
2	1/8" BSP	<b>555040202</b>	<b>4,73</b>
2	1/4" BSP	<b>555040404</b>	<b>4,64</b>
2	3/8" BSP	<b>555040606</b>	<b>6,42</b>

## Hembra asiento plano con junta manómetro

Swivel female flat seat with o'ring for manometer  
Micro-hose

Embout femelle tournante fond plat + o'ring  
pour manomètre Minimess

Femmina sede piana con o'ring per manometro

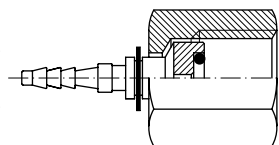

DN	THREAD ROSCA	Part n° Referencia	€
2	1/4" BSP	<b>555050404</b>	<b>4,45</b>
2	1/2" BSP	<b>555050808</b>	<b>7,85</b>

## Codo 90° hembra asiento plano con junta manómetro

90° Swivel female flat seat with o'ring for  
manometer

Coude 90° prise de pression femelle fond plat  
avec o'ring

Presca di pressione femmina 90° faccia piana con  
o-ring per manometro

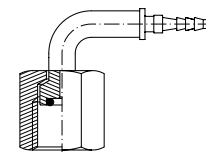

DN	THREAD ROSCA	Part n° Referencia	€
2	1/4" BSP	<b>555150404</b>	<b>35,24</b>

## Hembra giratoria Métrica con junta

Metric swivel female with o'ring

Embout femelle tournante Métrique 24° pour  
raccord de control + o'ring minimess

Femmina Metrica 24° con o'ring

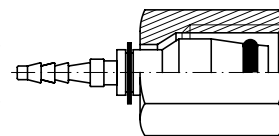

DN	PIPE TUBO	THREAD ROSCA	Part n° Referencia	€
2	6L	M12X1.5	<b>555079510</b>	<b>4,16</b>
2	6S	M14X1.5	<b>555079511</b>	<b>4,16</b>
2	8L	M14X1.5	<b>555079512</b>	<b>4,34</b>
2	8S	M16X1.5	<b>555079523</b>	<b>4,54</b>
2	10L	M16X1.5	<b>555079525</b>	<b>7,42</b>

## Macho de control

Straight Micro-hose check male

Embout mâle manomètre

Presca di pressione maschio

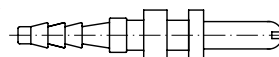

DN	Part n° Referencia	€
2	<b>555030325</b>	<b>2,82</b>

# Conexiones Serie Micro-hose

Micro-hose fittings  
Embouts manomètres  
Raccordi per micro-tubi

## Espiga lisa Métrica

Metric standpipe Micro-hose

Embout lisse Métrique Minimess

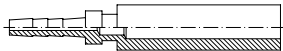

Estremitá tubolare Metrica

DN	PIPE TUBO	Part nº Referencia	€
2	6	<b>555070600</b>	<b>2,73</b>
2	8	<b>555070800</b>	<b>2,62</b>

## Espiga a 90° lisa Métrica

90° Metric standpipe Micro-hose

Embout lisse coude 90° Métrique Minimess

Estremitá tubolare a 90° Metrica

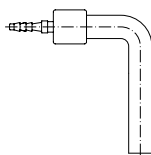

DN	PIPE TUBO	Part nº Referencia	€
2	6	<b>555170600</b>	<b>5,02</b>

## Hembra giratoria recta JIC 37°

Straight swivel female JIC 37° Micro-hose

Embout femelle tournante JIC 37° Minimess

Femmina diritta JIC 37°

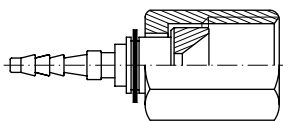

DN	THREAD ROSCA	Part nº Referencia	€
2	7/16" 20h UNF	<b>555090700</b>	<b>3,81</b>
2	1/2" 20h UNF	<b>555090800</b>	<b>5,11</b>
2	9/16" 18h UNF	<b>555090900</b>	<b>5,22</b>

## Orientable Métrico

Metric Banjo Micro-hose

Embout Banjo Métrique Minimess

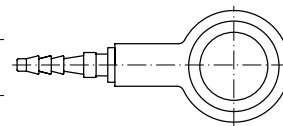

Raccordo ad occhio Metrico

DN	THREAD ROSCA	Part nº Referencia	€
2	M10X1	<b>555081000</b>	<b>6,77</b>

## Macho NPT

Male NPT

Mâle NPT

Maschio NPT

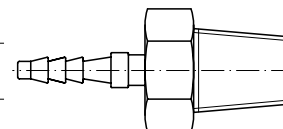

DN	THREAD ROSCA	Part nº Referencia	€
2	1/8" NPT	<b>555130200</b>	<b>4,25</b>

## Macho BSP

BSP Male

Mâle BSP

Maschio BSP

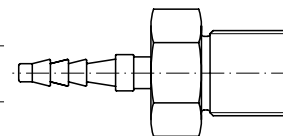

DN	THREAD ROSCA	Part nº Referencia	€
2	1/8" BSP	<b>555020202</b>	<b>4,63</b>
2	1/4" BSP	<b>555020404</b>	<b>14,25</b>

## Protector de polvo

Dust protector

Protecteur de poussière

Protezione per polvere

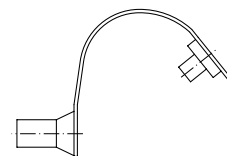

DESCRIPTION DESCRIPCIÓN	Part nº Referencia	€
PLASTIC	<b>54000000P</b>	<b>0,27</b>

# Racores de control

Test couplings  
Prises de pression  
Prese di pressione

## Racor de control rosca Métrica DIN 3852 (tapón metálico)

Check coupling male metric thread (metallic cap)

Prise de pression métrique (capuchon métallique)

Prese di pressione Metrica DIN 3852 (tappo metallico)

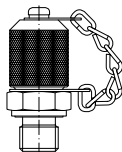

THREAD ROSCA	DESCRIPTION DESCRIPCIÓN	Part nº Referencia	€
M10X1	16x1.5	<b>MPL M 10X1 CM</b>	<b>19,12</b>

Otras figuras, consultar / For other designs, please consult us / Pour d'autres figures, consultez-nous / Per altre figure, vi preghiamo di consultarci

## Racor de control rosca BSP (tapón metálico)

Check coupling BSP (metallic cap)

Prise de pression BSP (capuchon métallique)

Prese di pressione BSP (tappo metallico)

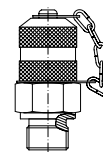

THREAD ROSCA	DESCRIPTION DESCRIPCIÓN	Part nº Referencia	€
1/8" BSP	16x1.5	<b>MPL 1/8 G CM</b>	<b>8,95</b>
1/4" BSP	16x1.5	<b>MPL 1/4 G CM</b>	<b>8,78</b>

Otras figuras, consultar / For other designs, please consult us / Pour d'autres figures, consultez-nous / Per altre figure, vi preghiamo di consultarci

## Racor de control rosca BSP con junta (tapón plástico)

Check coupling male thread BSP with captive seal (plastic cap)

Prise de pression avec joint (capuchon plastique)

Prese di pressione BSP con giunta (tappo plastica)



THREAD ROSCA	DESCRIPTION DESCRIPCIÓN	Part nº Referencia	€
1/8" BSP	16x2	<b>MPR 1/8 C/J</b>	<b>6,85</b>
1/4" BSP	16x2	<b>MPR 1/4 C/J</b>	<b>6,70</b>
3/8" BSP	16x2	<b>MPR 3/8 C/J</b>	<b>6,85</b>
1/2" BSP	16x2	<b>MPR 1/2 C/J</b>	<b>7,17</b>

## Racor de control rosca NPT (tapón plástico)

Check coupling male thread NPT (plastic cap)

Prise de pression NPTF (capuchon plastique)

Prese di pressione NPTF (tappo plastica)

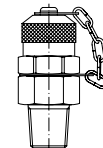

THREAD ROSCA	DESCRIPTION DESCRIPCIÓN	Part nº Referencia	€
1/8" NPT	16x2	<b>MPR 1/8 NPT</b>	<b>7,47</b>
1/4" NPT	16x2	<b>MPR 1/4 NPT</b>	<b>7,47</b>
3/8" NPT	16x2	<b>MPR 3/8 NPT</b>	<b>7,63</b>

## Racor de control rosca BSP (tapón plástico)

Check coupling male thread BSP (plastic cap)

Prise de pression (capuchon plastique)

Prese di pressione BSP (tappo plastica)

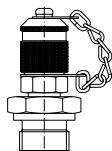

THREAD ROSCA	DESCRIPTION DESCRIPCIÓN	Part nº Referencia	€
1/8" BSP	16x2	<b>MPR 1/8 G</b>	<b>6,93</b>
1/4" BSP	16x2	<b>MPR 1/4 G</b>	<b>6,93</b>
3/8" BSP	16x2	<b>MPR 3/8 G</b>	<b>7,07</b>
1/2" BSP	16x2	<b>MPR 1/2 G</b>	<b>6,83</b>

## Racor de control rosca Métrica DIN 3852 (tapón plástico)

Check coupling male metric thread (plastic cap)

Prise de pression métrique (capuchon plastique)

Prese di pressione Metrica DIN 3852 (tappo plastica)

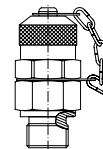

THREAD ROSCA	DESCRIPTION DESCRIPCIÓN	Part nº Referencia	€
M10X1	16x2	<b>MPR M10X1</b>	<b>7,98</b>
M12X1.5	16x2	<b>MPR M12X1.5</b>	<b>7,47</b>
M14X1.5	16x2	<b>MPR M14X1.5</b>	<b>7,47</b>
M16X1.5	16x2	<b>MPR M16X1.5</b>	<b>7,63</b>

## Racor de control rosca cónica BSPT (tapón plástico)

Check coupling male BSP tapered (plastic cap)

Prise de pression BSPT (capuchon plastique)

Prese di pressione conica BSPT (tappo plastica)

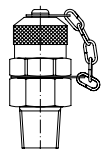

THREAD ROSCA	DESCRIPTION DESCRIPCIÓN	Part nº Referencia	€
1/8" BSPT	16x2	<b>MPR 1/8 BSPT</b>	<b>7,46</b>
1/4" BSPT	16x2	<b>MPR 1/4 BSPT</b>	<b>7,47</b>
3/8" BSPT	16x2	<b>MPR 3/8 BSPT</b>	<b>8,32</b>

## Racor de control macho Métrico con junta (Tapón plástico)

Check coupling male metric thread + o'ring (plastic cap)

Prise de pression métrique avec o'ring (capuchon plastique)

Prese di pressione Metrica con o'ring (tappo plastica)

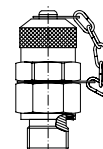

THREAD ROSCA	Part nº Referencia	€
M10x1	<b>MPR M10X1 C/J</b>	<b>6,72</b>
M12x1.5	<b>MPR M12X1.5 C/J</b>	<b>6,72</b>
M14x1.5	<b>MPR M14X1.5 C/J</b>	<b>6,57</b>
M16x1.5	<b>MPR M16X1.5 C/J</b>	<b>6,86</b>

# Racores de control

Test couplings  
Prises de pression  
Prese di pressione

## Racor de control rosca Métrica (tapón plástico)

Check coupling male metric thread (plastic cap)

Prise de pression métrique (capuchon plastique)

Prese di pressione Metrica (tappo plastica)



THREAD ROSCA	DESCRIPTION DESCRIPCIÓN	Part nº Referencia	€
M8X1	16x2	<b>MPR A 8X1</b>	<b>7,38</b>
M10X1	16x2	<b>MPR A 10X1</b>	<b>7,38</b>
M10X1.25	16x2	<b>MPR A 10X1.25</b>	<b>7,38</b>

## Racor de control tubular Métrico (tapón plástico)

Check coupling male metric tubular (plastic cap)

Prise de pression avec embout lisse (capuchon plastique)

Prese di pressione con tubolare Metrico (tappo plastica)

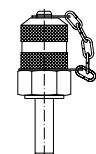

PIPE TUBO	DESCRIPTION DESCRIPCIÓN	Part nº Referencia	€
6	16x2	<b>MPR TUB.6</b>	<b>7,22</b>
8	16x2	<b>MPR TUB.8</b>	<b>7,22</b>
10	16x2	<b>MPR TUB.10</b>	<b>7,22</b>
12	16x2	<b>MPR TUB.12</b>	<b>7,22</b>
15	16x2	<b>MPR TUB.15</b>	<b>7,22</b>

## Racor de control rosca SAE - UNF (tapón plástico)

Check coupling male thread UNF (plastic cap)

Prise de pression filetage SAE/UNF (capuchon plastique)

Prese di controllo SAE - UNF (tappo plastica)



THREAD ROSCA	DESCRIPTION DESCRIPCIÓN	Part nº Referencia	€
7/16" 20h UNF	16x2	<b>MPR 7/16 UNF</b>	<b>7,38</b>
1/2" 20h UNF	16x2	<b>MPR 1/2 UNF</b>	<b>7,39</b>
9/16" 18h UNF	16x2	<b>MPR 9/16 UNF</b>	<b>7,38</b>

## Racor de control hembra giratoria Métrica con junta (tapón metálico)

Check coupling Metric swivel female + o'ring (metallic cap)

Prise de pression femelle tournante Métrique + o'ring (capuchon métallique)

Prese di pressione femmina girevole Metrica con o'ring (tappo metallico)

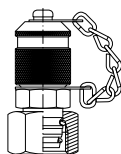

PIPE TUBO	THREAD ROSCA	DESCRIPTION DESCRIPCIÓN	Part nº Referencia	€
6L	M12X1.5	16x2	<b>MPR TLM 6L CM</b>	<b>11,56</b>
8L	M14X1.5	16x2	<b>MPR TLM 8L CM</b>	<b>12,03</b>
10L	M16X1.5	16x2	<b>MPR TLM 10L CM</b>	<b>12,47</b>
12L	M18X1.5	16x2	<b>MPR TLM 12L CM</b>	<b>11,77</b>
15L	M22X1.5	16x2	<b>MPR TLM 15L CM</b>	<b>10,66</b>

Otras medidas, consultar / For other dimensions, please consult us / Pour d'autres dimensions, consultez-nous / Per altre dimensioni, vi preghiamo di consultarci

## Racor de control macho Métrico con junta (tapón metálico)

Check coupling metric male + o'ring (metallic cap)

Prise de pression mâle + o'ring (capuchon métallique)

Prese di pressione maschio Metrico con o'ring (tappo metallico)

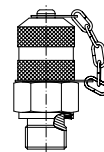

THREAD ROSCA	DESCRIPTION DESCRIPCIÓN	Part nº Referencia	€
M10X1	16x2	<b>MPR M 10X1 CM</b>	<b>8,05</b>
M12X1.5	16x2	<b>MPR M 12X1.5 CM</b>	<b>8,77</b>

## Racor de control rosca BSP con junta tórica (tapón metálico)

Check coupling BSP with o'ring (metallic cap)

Prise de pression BSP avec o'ring (capuchon métallique)

Prese di pressione BSP con o-ring (tappo metallico)

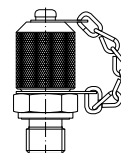

THREAD ROSCA	DESCRIPTION DESCRIPCIÓN	Part nº Referencia	€
1/8" BSP	16x2	<b>MPR 1/8 C/J CM</b>	<b>8,05</b>
1/4" BSP	16x2	<b>MPR 1/4 C/J CM</b>	<b>7,30</b>

## Racor de control rosca BSP (tapón metálico)

Check coupling BSP (metallic cap)

Prise de pression BSP (capuchon métallique)

Prese di pressione BSP (tappo metallico)

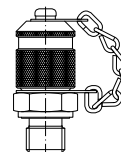

THREAD ROSCA	DESCRIPTION DESCRIPCIÓN	Part nº Referencia	€
1/8" BSP	16x2	<b>MPR 1/8 G CM</b>	<b>8,60</b>
1/4" BSP	16x2	<b>MPR 1/4 G CM</b>	<b>8,60</b>

## Racor de control intermedio (tapón metálico)

Halk-way check coupling (metallic cap)

Prise de pression intermédiaire (capuchon métallique)

Prese di pressione intermedio (tappo metallico)

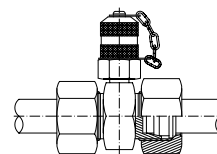

PIPE TUBO	DESCRIPTION DESCRIPCIÓN	Part nº Referencia	€
6L	16x2	<b>MPR DL 6 CM</b>	<b>15,00</b>
8L	16x2	<b>MPR DL 8 CM</b>	<b>14,45</b>
10L	16x2	<b>MPR DL 10 CM</b>	<b>14,94</b>
12L	16x2	<b>MPR DL 12 CM</b>	<b>15,43</b>
15L	16x2	<b>MPR DL 15 CM</b>	<b>16,25</b>

## Capuchón protector toma de presión

Protective cap - check coupling for manometer

Capuchon Minimess

Cappuccio di protezione per presa di pressione

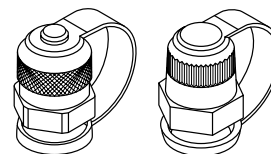

CAPS CAPUCHON	Part nº Referencia	€
CARBON STEEL	<b>27CA0000</b>	<b>2,01</b>
PLASTIC	<b>28CP0000</b>	<b>1,55</b>

# Racores de control

Test couplings  
Prises de pression  
Prese di pressione

## Conex. manómetro-pasatabiques BSP

Check coupling BSP bulkhead for manometer

Prise de pression passe cloison sans capuchon

Raccordo Manometro - passaparete maschio BSP

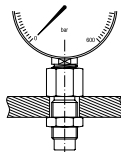

THREAD ROSCA		Part n° Referencia	€
1/4" BSP	M16x2	<b>MPR PT 1/4 BSP</b>	<b>9,82</b>
1/2" BSP	M16x2	<b>MPR PT 1/2 BSP</b>	<b>14,31</b>

## Conex. manómetro - toma de control

Check coupling for manometer

Raccord de contrôle direct à manomètre sans capuchon

Raccordo manometro - presa di pressione

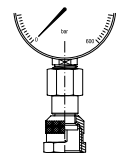

THREAD ROSCA		Part n° Referencia	€
1/4" BSP	M16x2	<b>MPD 1/4 BSP</b>	<b>12,16</b>
1/2" BSP	M16x2	<b>MPD 1/2 BSP</b>	<b>16,30</b>

## Conex. manómetro-hembra 90° BSP

Check coupling 90° BSP swivel female for manometer

Raccord de contrôle 90° orientable sans capuchon direct à manomètre

Raccordo manometro - femmina a 90° BSP

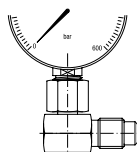

THREAD ROSCA		Part n° Referencia	€
1/4" BSP	M 16x2	<b>MPD 90 1/4 BSP</b>	<b>15,93</b>
1/2" BSP	M 16x2	<b>MPD 90 1/2 BSP</b>	<b>17,37</b>

## Protector de manómetro en línea MF-TL recto

Pressure Gauge Protector (in-line) FM-SF straight

Isolateur de manomètre (en ligne) MF-FT droit

Esclusore per manometro in linea M-F gir. diritto



THREAD ROSCA		MAX. PRESSURE (bar) PRESIÓN MAX. (bar)	Part n° Referencia	€
1/4" BSP	1/4" BSPT	350	<b>FT29004</b>	*
1/2" BSP	1/2" BSPT	350	<b>FT29008</b>	*

Ver precios en catálogo componentes / See prices in components catalogue / Voir les prix dans le composant catalogue / Vedere prezzi nel catalogo Componenti

## Protector de manómetro en línea MF-TL 90°

Pressure Gauge Protector (in-line) FM-SF 90°

Isolateur de manomètre (en ligne) MF-FT 90°

Esclusore per manometro in linea M-F gir. 90°



THREAD ROSCA		MAX. PRESSURE (bar) PRESIÓN MAX. (bar)	Part n° Referencia	€
1/4" BSP	1/4" BSPT	350	<b>FT29104</b>	*

Ver precios en catálogo componentes / See prices in components catalogue / Voir les prix dans le composant catalogue / Vedere prezzi nel catalogo Componenti

## Conex. manómetro M-M

Male-Male check coupling for manometer

Prise de pression manomètre Mâle-Mâle

Adattatore M-M presa di pressione per manometro

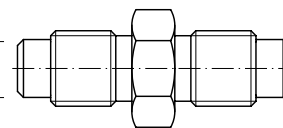

THREAD ROSCA		Part n° Referencia	€
M16X2	M16X1.5	<b>MPU 16X2</b>	<b>19,29</b>
M16X1.5	M16X1.5	<b>MPU 16X1.5</b>	<b>19,03</b>

## Conex. Métrica para manómetros

Metric check coupling for manometer

Prise de contrôle métrique pour manomètre

Presa di pressione metrica per manometro

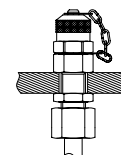

PIPE TUBO	THREAD ROSCA	Part n° Referencia	€
8S	M16X1.5	<b>MPR PT 16X1.5</b>	<b>18,06</b>
10S	M18X1.5	<b>MPR PT 18X1.5</b>	<b>22,55</b>

## Adaptador para manómetro en línea MF-TL

Pressure Gauge Adaptor (in-line) FM-SF

Adapteur pour Manomètre (en ligne) MF-FT

Adattatore per manometro in linea M-F gir.



THREAD ROSCA		Part n° Referencia	€
1/4" BSP	1/2" BSPT	<b>FT29942</b>	*
1/4" BSP	1/4" BSPT	<b>FT29944</b>	*

Ver precios en catálogo componentes / See prices in components catalogue / Voir les prix dans le composant catalogue / Vedere prezzi nel catalogo Componenti

# Instrumentos de medición

Pressure and vacuum gauges  
Manomètres et vacuomètres  
Manometri e vacuometri

Hoses

Flexible hose fittings

Flow measuring

Equipment for flexible hoses

## Manómetro DN 63 vertical con glicerina (1/4" BSP)

Pressure gauge DN 63 vertical connection with glycerin (1/4" BSP)

Manomètre DN 63 sortie verticale avec glycérine (1/4" BSP)

Manometro DN 63 radiale a bagno di glicerina (1/4" BSP)



THREAD ROSCA	SCALE (bar) ESCALA (bar)	Part nº Referencia	€
1/4" BSP	0-1	MF16304001V	16,00
1/4" BSP	0-2.5	MF163042.5V	16,00
1/4" BSP	0-4	MF16304004V	16,00
1/4" BSP	0-6	MF16304006V	16,00
1/4" BSP	0-10	MF16304010V	16,00
1/4" BSP	0-12	MF16304012V	16,00
1/4" BSP	0-16	MF16304016V	16,00
1/4" BSP	0-20	MF16304020V	16,00
1/4" BSP	0-25	MF16304025V	16,00
1/4" BSP	0-40	MF16304040V	16,00
1/4" BSP	0-60	MF16304060V	16,00
1/4" BSP	0-100	MF16304100V	16,00
1/4" BSP	0-160	MF16304160V	16,00
1/4" BSP	0-250	MF16304250V	16,00
1/4" BSP	0-315	MF16304315V	16,00
1/4" BSP	0-400	MF16304400V	16,00
1/4" BSP	0-600	MF16304600V	16,00
1/4" BSP	0-1000	MF163041000V	17,39

## Manómetro DN 63 dorsal con glicerina (1/4" BSP)

Pressure gauge DN 63 rear connection with glycerin (1/4" BSP)

Manomètre DN 63 sortie arrière avec glycérine (1/4" BSP)

Manometro DN 63 assiale flangiato a bagno di glicerina (1/4" BSP)



THREAD ROSCA	SCALE (bar) ESCALA (bar)	Part nº Referencia	€
1/4" BSP	0-1	MF16304001-DB	20,53
1/4" BSP	0-2.5	MF163042.5-DB	20,53
1/4" BSP	0-4	MF16304004-DB	20,53
1/4" BSP	0-6	MF16304006-DB	20,53
1/4" BSP	0-10	MF16304010-DB	20,53
1/4" BSP	0-12	MF16304012-DB	20,53
1/4" BSP	0-16	MF16304016-DB	20,53
1/4" BSP	0-20	MF16304020-DB	20,53
1/4" BSP	0-25	MF16304025-DB	20,53
1/4" BSP	0-40	MF16304040-DB	20,53
1/4" BSP	0-60	MF16304060-DB	20,53
1/4" BSP	0-100	MF16304100-DB	20,53
1/4" BSP	0-160	MF16304160-DB	20,53
1/4" BSP	0-250	MF16304250-DB	20,53
1/4" BSP	0-315	MF16304315-DB	20,53
1/4" BSP	0-400	MF16304400-DB	20,53
1/4" BSP	0-600	MF16304600-DB	20,53

## Manómetro DN 100 vertical con glicerina (1/2" BSP)

Pressure gauge DN 100 vertical connection with glycerin (1/2" BSP)

Manomètre DN 100 sortie verticale avec glycérine (1/2" BSP)

Manometro DN 100 radiale a bagno di glicerina (1/2" BSP)



THREAD ROSCA	SCALE (bar) ESCALA (bar)	Part nº Referencia	€
1/2" BSP	0-1	MF110008001V	40,84
1/2" BSP	0-2.5	MF11000802.5V	40,84
1/2" BSP	0-4	MF110008004V	40,84
1/2" BSP	0-6	MF110008006V	40,84
1/2" BSP	0-10	MF110008010V	40,84
1/2" BSP	0-12	MF110008012V	40,84
1/2" BSP	0-16	MF110008016V	40,84
1/2" BSP	0-20	MF110008020V	40,84
1/2" BSP	0-25	MF110008025V	40,84
1/2" BSP	0-40	MF110008040V	40,84
1/2" BSP	0-60	MF110008060V	40,84
1/2" BSP	0-100	MF110008100V	40,84
1/2" BSP	0-160	MF110008160V	40,84
1/2" BSP	0-250	MF110008250V	40,84
1/2" BSP	0-315	MF110008315V	40,84
1/2" BSP	0-400	MF110008400V	40,84
1/2" BSP	0-600	MF110008600V	40,84

## Manómetro DN 100 dorsal con glicerina (1/2" BSP)

Pressure gauge DN 100 rear connection with glycerin (1/2" BSP)

Manomètre DN 100 sortie arrière avec glycérine (1/2" BSP)

Manometro DN 100 assiale flangiato a bagno di glicerina (1/2" BSP)



THREAD ROSCA	SCALE (bar) ESCALA (bar)	Part nº Referencia	€
1/2" BSP	0-1	MF110008001-DB	45,89
1/2" BSP	0-2.5	MF1100082.5-DB	45,89
1/2" BSP	0-4	MF110008004-DB	45,89
1/2" BSP	0-6	MF110008006-DB	45,89
1/2" BSP	0-10	MF110008010-DB	45,89
1/2" BSP	0-16	MF110008016-DB	45,89
1/2" BSP	0-25	MF110008025-DB	45,89
1/2" BSP	0-40	MF110008040-DB	45,89
1/2" BSP	0-60	MF110008060-DB	45,89
1/2" BSP	0-100	MF110008100-DB	45,89
1/2" BSP	0-160	MF110008160-DB	45,89
1/2" BSP	0-250	MF110008250-DB	45,89
1/2" BSP	0-315	MF110008315-DB	45,89
1/2" BSP	0-400	MF110008400-DB	45,89
1/2" BSP	0-600	MF110008600-DB	45,89



ENAC

**MANÓMETROS CALIBRADOS  
BAJO CONSULTA**

**CALIBRATED MANOMETER  
ON REQUEST**

# Instrumentos de medición

Pressure and vacuum gauges  
Manomètres et vacuomètres  
Manometri e vacuometri

## Manómetro DN 63 dorsal sin brida, con glicerina (1/4" BSP)

Pressure gauge DN 63 rear connection without flange, with glycerin (1/4" BSP)

Manomètre DN 63 sortie arrière sans bride, avec glycérine (1/4" BSP)

Manometro DN 63 assiale, a bagno di glicerina (1/4" BSP)



THREAD ROSCA	SCALE (bar) ESCALA (bar)	Part n° Referencia	€
1/4" BSP	0-1	MFI6304001-DBSB	17,19
1/4" BSP	0-2.5	MFI63042.5-DBSB	17,19
1/4" BSP	0-4	MFI6304004-DBSB	17,19
1/4" BSP	0-6	MFI6304006-DBSB	17,19
1/4" BSP	0-10	MFI6304010-DBSB	17,19
1/4" BSP	0-12	MFI6304012-DBSB	17,19
1/4" BSP	0-16	MFI6304016-DBSB	17,19
1/4" BSP	0-20	MFI6304020-DBSB	17,19
1/4" BSP	0-25	MFI6304025-DBSB	17,19
1/4" BSP	0-40	MFI6304040-DBSB	17,19
1/4" BSP	0-60	MFI6304060-DBSB	17,19
1/4" BSP	0-100	MFI6304100-DBSB	17,19
1/4" BSP	0-160	MFI6304160-DBSB	17,19
1/4" BSP	0-250	MFI6304250-DBSB	17,19
1/4" BSP	0-315	MFI6304315-DBSB	17,19
1/4" BSP	0-400	MFI6304400-DBSB	17,19
1/4" BSP	0-600	MFI6304600-DBSB	17,19

Consultar disponibilidad. Posibilidad de modelo con DN 100 / Check availability. It is also available with DN 100 / Disponibilité à consulter / Possibilité aussi en DN100 / Richiedere disponibilità / Possibilità del modello con DN 100

## Manómetro DN 63 dorsal sin brida con abrazadera, con glicerina (1/4" BSP)

Pressure gauge DN 63 rear connection without flange with clamp, with glycerin (1/4" BSP)

Manomètre DN63 sortie arrière avec glycérine, collier de fixation sans collerette

Manometro DN 63 assiale con collare, con glicerina 1/4" BSP)



THREAD ROSCA	SCALE (bar) ESCALA (bar)	Part n° Referencia	€
1/4" BSP	0-6	MFI6304006-DBCA	20,77
1/4" BSP	0-10	MFI6304010-DBCA	20,77
1/4" BSP	0-16	MFI6304016-DBCA	20,77
1/4" BSP	0-40	MFI6304040-DBCA	20,77
1/4" BSP	0-60	MFI6304060-DBCA	20,77
1/4" BSP	0-100	MFI6304100-DBCA	20,77
1/4" BSP	0-160	MFI6304160-DBCA	20,77
1/4" BSP	0-250	MFI6304250-DBCA	20,77
1/4" BSP	0-400	MFI6304400-DBCA	20,77

Consultar disponibilidad. Posibilidad de modelo con DN 100 / Check availability. It is also available with DN 100 / Disponibilité à consulter / Possibilité aussi en DN100 / Richiedere disponibilità / Possibilità del modello con DN 100

## Abrazadera para manómetro DN 63 / DN 100 dorsal

DN 63 / DN100 rear connection pressure gauge clamp

Collier pour manomètre DN 63 / DN100 sortie arrière

Collare per manometro DN 63 / DN100 assiale flangiato



DESCRIPTION DESCRIPCIÓN	Part n° Referencia	€
CLAMP (63mm)	ABRMFI63	3,58
CLAMP (100mm)	ABRMFI100	5,01

Consultar disponibilidad. Posibilidad de modelo con DN 100 / Check availability. It is also available with DN 100 / Disponibilité à consulter / Possibilité aussi en DN100 / Richiedere disponibilità / Possibilità del modello con DN 100

## Manómetro DN 63 vertical con glicerina (1/4" NPT)

Pressure gauge DN 63 vertical connection with glycerin (1/4" NPT)

Manomètre DN 63 sortie verticale avec glycérine (1/4" NPT)

Manometro DN 63 radiale a bagno di glicerina (1/4" NPT)



THREAD ROSCA	SCALE (bar) ESCALA (bar)	Part n° Referencia	€
1/4" NPT	0-10	MFI6304010V NPT	16,47
1/4" NPT	0-16	MFI6304016V NPT	16,47
1/4" NPT	0-25	MFI6304025V NPT	16,47
1/4" NPT	0-60	MFI6304060V NPT	16,47
1/4" NPT	0-160	MFI6304160V NPT	16,47
1/4" NPT	0-250	MFI6304250V NPT	16,47
1/4" NPT	0-400	MFI6304400V NPT	16,47

## Manómetro DN 63 dorsal con glicerina (1/4" NPT)

Pressure gauge DN 63 rear connection with glycerin (1/4" NPT)

Manomètre DN 63 sortie arrière avec glycérine (1/4" NPT)

Manometro DN 63 assiale flangiato a bagno di glicerina (1/4" NPT)



THREAD ROSCA	SCALE (bar) ESCALA (bar)	Part n° Referencia	€
1/4" NPT	0-10	MFI6304010-DB NPT	21,13
1/4" NPT	0-16	MFI6304016-DB NPT	21,13
1/4" NPT	0-25	MFI6304025-DB NPT	21,13
1/4" NPT	0-60	MFI6304060-DB NPT	21,13
1/4" NPT	0-160	MFI6304160-DB NPT	21,13
1/4" NPT	0-250	MFI6304250-DB NPT	21,13
1/4" NPT	0-400	MFI6304400-DB NPT	21,13

Consultar disponibilidad. Posibilidad de modelo con DN 100 / Check availability. It is also available with DN 100 / Disponibilité à consulter / Possibilité aussi en DN100 / Richiedere disponibilità / Possibilità del modello con DN 100

## Manómetro DN 100 vertical con glicerina (1/2" NPT)

Pressure gauge DN 100 vertical connection with glycerin (1/2" NPT)

Manomètre DN 100 sortie verticale avec glycérine (1/2" NPT)

Manometro DN 100 radiale a bagno di glicerina (1/2" NPT)



THREAD ROSCA	SCALE (bar) ESCALA (bar)	Part n° Referencia	€
1/2" NPT	0-10	MFI10008010V NPT	40,84
1/2" NPT	0-25	MFI10008025V NPT	40,84
1/2" NPT	0-60	MFI10008060V NPT	40,84
1/2" NPT	0-250	MFI10008250V NPT	40,84
1/2" NPT	0-400	MFI10008400V NPT	40,84
1/2" NPT	0-600	MFI10008600V NPT	40,84

## Manómetro de colores dorsal (1/8" BSPT)

Pressure gauge in colours rear connection (1/8" BSPT)

Manomètre à couleurs sortie arrière avec glycérine (1/8" BSPT)

Manometro a colori assiale flangiato (1/8" BSPT)



SCALE (bar) ESCALA (bar)	Part n° Referencia	€
0-6	MFI CO 06	6,61

# Instrumentos de medición

Pressure and vacuum gauges  
Manomètres et vacuomètres  
Manometri e vacuometri

Hoses

Flexible hose fittings

Flow measuring

Equipment for flexible hoses

## Manómetro digital DN63 vertical (1/4" BSP)

Pressure gauge DN63 rear connection with glycerin (1/4" BSP)

Manomètre digital DN 63 sortie verticale (1/4" BSP)

Manomètre digital DN63 (1/4" BSP)



THREAD ROSCA	SCALE (bar) ESCALA (bar)	Part n° Referencia	€
1/4" BSP	0-600	<b>MANDIG63V</b>	<b>234,73</b>

## Manómetro digital DN100 vertical (1/2" BSP)

Digital pressure gauge DN100 vertical connection (1/2" BSP)

Manomètre digital DN 100 sortie verticale (1/2" BSP)

Manomètre digital DN100



THREAD ROSCA	SCALE (bar) ESCALA (bar)	Part n° Referencia	€
1/2" BSP	0-1000	<b>MANDIG100V</b>	<b>722,90</b>

## Vacuómetro DN 63 con glicerina (1/4" BSP)

Vacuum gauge DN 63 with glycerin (1/4" BSP)

Vacuomètre DN 63 avec glycerine (1/4" BSP)

Vacuometro DN 63 a bagno di glicerina (1/4" BSP)



SCALE (bar) ESCALA (bar)	Part n° Referencia	€
-1-0	<b>VAC6304-01I</b>	<b>16,83</b>

## Vacuómetro de colores dorsal (1/8" BSP)

Vacuum gauges in colours rear connection (1/8" BSP)

Vacuomètre à couleurs sortie arrière (1/8" BSP)

Vacuometro a colori assiale flangiato (1/8" BSP)



SCALE (bar) ESCALA (bar)	Part n° Referencia	€
-1-0	<b>MFI VA 01</b>	<b>6,49</b>

## Termomanómetro DN 63 vertical (1/4" BSP)

Temperature- pressure gauge DN 63 vertical connection (1/4" BSP)

Thermo-manomètre DN63 sortie vertical (1/4" BSP)

Termomanometro DN 63 verticale (1/4" BSP)



THREAD ROSCA	SCALE (bar) ESCALA (bar)	Part n° Referencia	€
1/4" BSP	0-4	<b>MFIT6304004V</b>	<b>29,72</b>
1/4" BSP	0-16	<b>MFIT6304016V</b>	<b>29,72</b>
1/4" BSP	0-40	<b>MFIT6304040V</b>	<b>29,72</b>

Temp: 0-120°C

## Termomanómetro DN 63 dorsal (1/4" BSP)

Temperature- pressure gauge DN 63 rear connection (1/4" BSP)

Thermo-manomètre DN63 sortie arrière (1/4" BSP)

Termomanometro DN 63 assiale (1/4" BSP)



THREAD ROSCA	SCALE (bar) ESCALA (bar)	Part n° Referencia	€
1/4" BSP	0-4	<b>MFIT6304004-DB</b>	<b>28,29</b>
1/4" BSP	0-16	<b>MFIT6304016-DB</b>	<b>28,29</b>
1/4" BSP	0-40	<b>MFIT6304040-DB</b>	<b>28,29</b>

Temp: 0-120°C

## Manovacuómetro DN 63 vertical con glicerina (1/4" BSP)

Manovacuumeter DN 63 vertical connection with glycerin (1/4" BSP)

Manovacuumètre DN 63 sortie verticale avec glycerine (1/4" BSP)

Manovacuumetro DN 63 verticale con glicerina (1/4" BSP)



THREAD ROSCA	SCALE (bar) ESCALA (bar)	Part n° Referencia	€
1/4" BSP	-1,+3	<b>MFIVAC6304003V</b>	<b>17,91</b>
1/4" BSP	-1,+5	<b>MFIVAC6304005V</b>	<b>17,91</b>
1/4" BSP	-1,+15	<b>MFIVAC6304015V</b>	<b>17,91</b>

## Manovacuómetro DN 63 dorsal con glicerina (1/4" BSP)

Manovacuumeter DN 63 rear connection with glycerin (1/4" BSP)

Manovacuumètre DN 63 sortie arrière avec glycerine (1/4" BSP)

Manovacuumetro DN 63 assiale con glicerina (1/4" BSP)



THREAD ROSCA	SCALE (bar) ESCALA (bar)	Part n° Referencia	€
1/4" BSP	-1,+3	<b>MFIVAC6304003-DB</b>	<b>22,56</b>
1/4" BSP	-1,+5	<b>MFIVAC6304005-DB</b>	<b>22,56</b>
1/4" BSP	-1,+15	<b>MFIVAC6304015-DB</b>	<b>22,56</b>

# Instrumentos de medición

Pressure and vacuum gauges  
Manomètres et vacuomètres  
Manometri e vacuometri

## Maletín medida de presión (0 manómetros)

Check cases (0 manometer)

Coffre de mesure (0 manomètre)

Valigetta misurazione di pressione (0 manometro)



SIZE TAMAÑO	SCALE (bar) ESCALA (bar)	Part n° Referencia	€
320x280x119	-	<b>CBOXMEDF</b>	<b>93,01</b>

## Maletín dos manómetros + accesorios tipo 1

Check case 2 manometers + accessories type 1

Coffre 2 manomètres + accessoires type 1

Valigetta con due manometri + accessori tipo 1



SIZE TAMAÑO	SCALE (bar) ESCALA (bar)	Part n° Referencia	€
320X280X119	0-160; 0-315	<b>CBOX0001</b>	<b>247,63</b>

## Maletín un manómetro digital + accesorios tipo 2

Check case 1 digital manometer + accessories type 2

Coffre 1 manomètre digital + accessoires type 2

Valigetta con uno manometri digitale+ accessori tipo 2



SIZE TAMAÑO	SCALE (bar) ESCALA (bar)	Part n° Referencia	€
320x280x119	0-1000	<b>CBOX0003</b>	<b>1.138,50</b>

## Maletín tres manómetros + accesorios tipo 2

Check case 3 manometers + accessories type 2

Coffre 3 manomètres + accessoires type 2

Valigetta con tre manometri + accessori tipo 2



SIZE TAMAÑO	SCALE (bar) ESCALA (bar)	Part n° Referencia	€
320x280x119	0-100; 0-250; 0-400	<b>CBOX0002</b>	<b>339,02</b>



**CBOX0001**



**CBOX0002**



**CBOX0003**

### 2 MANÓMETROS 1/4:

0-160  
0-315

### 3 MANÓMETROS 1/4

0-100  
0-250  
0-400

### 1 MANÓMETROS DIG.

0-1000

### ACCESORIOS TIPO 1:

1 MPR 1/4 C/J  
1 MPR 3/8 C/J  
1 MPR 1/4 NPT  
1 MPR A 10X1  
1 MPD 1/4 BSP  
1 CAPUCHÓN ACERO  
1 MPD 90 1/4 BSP  
1 LATIGUILLO MINIMEX TL-TL 16X2 1.5 MTS

### ACCESORIOS TIPO 2:

1 MPR 1/4 C/J  
1 MPR 3/8 C/J  
1 MPR 1/4 NPT  
1 MPR A 10X1  
1 MPD 1/4 BSP  
1 MPD 1/2 BSP  
1 CAPUCHÓN ACERO  
1 MPR PT 1/4 BSP  
1 LATIGUILLO MINIMEX TL-TL 16X2 1 MTS  
1 LATIGUILLO MINIMEX TL-TL 16X2 2 MTS  
1 MPR 7/16 UNF  
1 MPR 9/16 UNF  
1 MPR TLM 122 CM  
1 MPR 3/8 NPT

# Medidores de caudal

Flow tester  
Débitmètres  
Indicatori di flusso

Hoses

Flexible hose fittings

Flow measuring

Equipment for flexible hoses

## Caudalímetro 250 bar - Tipo 3 - 3/4" BSP

Flow tester type 3-3/4" BSP

Débitmètre 250 bar type 3-3/4" BSP

Flussostato 250 bar tipo 3-3/4" BSP



SCALE (l/min) ESCALA (l/min)	Part nº Referencia	€
0-56	<b>WPB3A6HT15</b>	<b>1.248,36</b>

## Caudalímetro 250 bar - Tipo 6 - 1 1/4" BSP

Flow tester type 6-1 1/4"

Débitmètre 250 bar type 6-1 1/4" BSP

Flussostato 250 bar tipo 6-1 1/4" BSP



SCALE (l/min) ESCALA (l/min)	Part nº Referencia	€
20-280	<b>WPB5A6HW75</b>	*

## Caudalímetro 250 bar - Tipo 5 - 1 1/2" BSP

Flow tester type 5-1 1/2" BSP

Débitmètre 250 bar type 5-1 1/2" BSP

Flussostato 250 bar tipo 5-1 1/2" BSP



SCALE (l/min) ESCALA (l/min)	Part nº Referencia	€
0-550	<b>WPB5A6HY99</b>	*

## Caudalímetro 420 bar - Tipo 57 - 3/4" BSP

Flow tester 420 bar Type 57 - 3/4" BSP

Débitmètre 420 bar Type 57 - 3/4" BSP

Flussostato 420 bar Tipo 57 - 3/4" BSP



SCALE (l/min) ESCALA (l/min)	Part nº Referencia	€
2-30	<b>FT5758-01</b>	<b>1.504,36</b>
2-60	<b>FT5758-02</b>	<b>1.643,66</b>
4-120	<b>FT5758-03</b>	<b>1.786,05</b>

## Caudalímetro 350 bar - Tipo 60 - 1" 1/2 BSP

Flow tester 350 bar Type 60 - 1" 1/2 BSP

Débitmètre 350 bar Type 60 - 1" 1/2 BSP

Flussostato 350 bar Tipo 60 - 1" 1/2 BSP



SCALE (l/min) ESCALA (l/min)	Part nº Referencia	€
10-200	<b>FT6068-01</b>	<b>3.024,21</b>
20-400	<b>FT6068-03</b>	<b>3.776,39</b>

## Caudalímetro 420 bar - con caja - 1" BSP

Flow tester 420 bar with box - 1" BSP

Débitmètre 420 bar avec boîte - 1" BSP

Flussostato 420 bar con cassa - 1" BSP



SCALE (l/min) ESCALA (l/min)	Part nº Referencia	€
10-120	<b>FT5594-03</b>	<b>4.225,22</b>
10-200	<b>FT5594-09</b>	<b>4.339,75</b>

## Máquinas tratamiento tubo flexible

*Equipment for flexible hoses*

Machines pour le montage des flexibles

*Macchine per l'assemblaggio di tubi flessibili*

## Máquinas tratamiento tubo flexible

*Equipment for flexible hoses*

Machines pour le montage des flexibles

*Macchine per l'assemblaggio di tubi flessibili*

110

4

# Flexibles industriales

*Industrial Flexible Hoses  
& Fittings*

Flexibles industriali

*Tubi flessibili e raccordi  
industriali*

**INDUS TrAle®**

Industrial Flexible Hoses & Fittings



**Mangueras industriales**

*Industrial hoses*  
Tuyaux industriels  
*Tubi industriali*

1

**Racores industriales**

*Industrial fittings*  
Raccords industriels  
*Raccordi industriali*

2

**Inox Corrugado**

*Stainless steel hose, welding fittings and flanges*  
Tuyau Inox, raccords et brides à souder  
*Tubi Inox, raccordi e flange a saldare*

3

**Baja presión**

*Low pressure*  
Basse pression  
*Tubi a bassa pressione*

4

**Aire acondicionado**

*Air conditioning hoses and fittings*  
Climatisation  
*Aria condizionata*

5

## Mangueras industriales

*Industrial hoses*

Tuyaux industriels

*Tubi industriali*

### **Manguera industrial INDUSTRΔle**

*Industrial hoses INDUSTRΔle*

Tuyaux industriels INDUSTRΔle

*Tubi industriali INDUSTRΔle*

1

**INDUS TrAle<sup>®</sup>**

# Manguera industrial INDUSTrAle

Industrial hoses INDUSTrAle  
Tuyaux industriels INDUSTrAle  
Tubi industriali INDUSTrAle

# INDUS TrAle®

- Mangueras aire-agua / Air-water hoses / Tuyaux air-eau / Tubo acqua-aria | 123



M8000

MM20

MI0101

MF80

MA1220

MI0102

MI0103

- Mangueras hidrocarburos / Hydrocarbon hoses / Tuyaux pour hydrocarbures / Tubo idrocarburi | 124



MI0401

MI0404

MI0403

M7000

ML7010

MSB21

- Mangueras soldadura / Welding hoses / Tuyaux pour soudure / Tubi saldatura | 125



MI0603

MI0601

MI0602

- Mangueras abrasivas / Abrasive hoses / Tuyaux abrasifs / Tubo abrasivo | 126



MI0301

MI0302

MI0303

MI0305

- Mangueras productos químicos / Chemical product hoses / Tuyaux pour produits chimiques / Tubo prodotti chimici | 126



MI0701

MI0702

- Mangueras alimentarias / Food hoses / Tuyaux alimentaires / Tubo alimentare | 127



MAS

MI0205

MI0206

# Manguera industrial INDUSTrAle

Industrial hoses INDUSTrAle  
Tuyaux industriels INDUSTrAle  
Tubi industriali INDUSTrAle

# INDUS TrAle®

Industrial hoses

Industrial fittings

Stainless steel hose, welding fittings and flanges

Low pressure

Air conditioning hoses and fittings

## Ariaform aire comprimido y agua-impulsión

Compressed Air hose - impulsion

Ariaform refoulement air comprimé et de l'eau



Tubo aria compressa e mandata

Ø INNER Ø INT.	Ø outer Ø ext	Part n° Referencia	€
6	14	M80000614	2,54
8	15	M80000817	2,77
10	17	M80001017	3,12
13	21	M80001321	4,82
16	26	M80001626	6,07
19	29	M80001929	6,70

## Polivalente serie continua

Multi-function. Continuous serie

Tuyau polyvalent huiles/eau



Polivalente. Serie continua

Ø INNER Ø INT.	Ø outer Ø ext	Part n° Referencia	€
8	15	MM2008	3,38
10	17	MM2010	4,44
13	21	MM2013	5,38
16	24	MM2016	6,81
19	27	MM2019	8,13
25	34	MM2025	12,32
32	44	MM2032	22,44
38	50	MM2038	27,76

## Aspiración agua 10 bar

Water suction hose 10 bar

Tuyau aspiration eau 10 bar



Tubo aspirazione acqua 10 bar

Ø INNER Ø INT.	Ø outer Ø ext	Part n° Referencia	€
25	35	MI01011025	25,28
30	40	MI01011030	28,10
32	42	MI01011032	29,48
35	45	MI01011035	30,63
38	48	MI01011038	32,37
40	50	MI01011040	32,79
51	62	MI01011051	39,51
60	71	MI01011060	47,50
63,5	76	MI01011063.5	49,84
70	82	MI01011070	56,51
76	88	MI01011076	62,09
80	92	MI01011080	65,87
90	102	MI01011090	78,91
102	117	MI01011102	84,31

## Fumigación serie continua

Fumigation hose. Continous serie

Tuyau fumigation



Fumigazione. Serie continua

Ø INNER Ø INT.	Ø outer Ø ext	Part n° Referencia	€
12,5	21	MF8012	8,88

## Aire comprimido y agua - impulsión

Compressed air and water impulsion

Air comprimé et eau- impulsion



Aria compressa e acqua - mandata

Ø INNER Ø INT.	Ø outer Ø ext	Part n° Referencia	€
25	35	MA122025	12,22
32	45	MA122032	18,72
38	51	MA122040	28,76
51	64	MA122051	37,85
63.5	79.5	MA122063	69,87
75	91	MA122075	77,63

## Vapor 18 bar, limpieza industrial 210°C

Steam hose 18 bar, industrial cleaning, 210°C

Tuyau vapeur 18 bar, nettoyage industriel 210°C



Vapore 18 bar, lavaggio industriale 210°C

Ø INNER Ø INT.	Ø outer Ø ext	Part n° Referencia	€
13,5	24,5	MI01021713	24,72
18	31	MI01021719	29,57
25	38	MI01021725	34,44
32	45	MI01021732	57,84
38	53	MI01021738	66,16
50,8	67	MI01021751	84,25
76,2	93	MI01021776	210,47

## Vapor 7 bar EPDM blanco FDA - limpieza industrial

Steam hose 7 bar, white EPDM FDA industrial cleaning

Tuyau vapeur 7 bar EPDM blanc FDA nettoyage industriel



Tubo vapore 7 bar EPDM bianco FDA pulizia industriale

Ø INNER Ø INT.	Ø outer Ø ext	Part n° Referencia	€
13	23	MI01030713	20,48
16	26	MI01030716	22,70
19	31	MI01030719	27,92
25	37	MI01030725	33,15

# Manguera industrial INDUSTrAle

Industrial hoses INDUSTrAle  
Tuyaux industriels INDUSTrAle  
Tubi industriali INDUSTrAle

# INDUS TrAle®

## Manguera hidrocarburos 10 bar impulsión

Hydrocarbons hose 10 bar discharge

Tuyau pour hydrocarbures 10 bar impulsion



Tubo idrocarburi 10 bar -mandata

Ø INNER Ø INT.	Ø outer Ø ext	Part nº Referencia	€
6	12	MI04011006	2,95
8	14	MI04011008	3,76
10	17	MI04011010	4,57
13	20	MI04011013	5,89
16	23	MI04011016	7,17
19	27	MI04011019	9,25
25	35	MI04011025	14,22
32	42	MI04011032	22,36

## Manguera hidrocarburos 20 bar impulsión

Hydrocarbons hose 20 bar discharge

Tuyau pour hydrocarbures 20 bar impulsion



Tubo idrocarburi 20 bar -mandata

Ø INNER Ø INT.	Ø outer Ø ext	Part nº Referencia	€
6	12	MI04042006	3,41
8	15	MI04042008	4,45
10	17	MI04042010	5,09
13	20	MI04042013	6,36
16	24	MI04042016	8,32
19	28	MI04042019	10,75
25	35	MI04042025	15,54
32	42	MI04042032	24,67

## Manguera hidrocarburos 10 bar aspiración

Hydrocarbons hose 10 bar intake

Tuyau pour hydrocarbures 10 bar aspiration



Tubo aspirazione 10 bar idrocarburi

Ø INNER Ø INT.	Ø outer Ø ext	Part nº Referencia	€
19	29	MI040310019	22,25
25	35	MI040310025	23,88
32	42	MI040310032	28,51
38	48	MI040310038	33,76
51	61,8	MI040310051	39,32
63	75	MI040310063	54,01
76	89	MI040310076	73,01
101,4	115,4	MI040310102	96,95

## Manguera CarbuCORD 16 bar

CarbuCORD hose 16 bar

Tuyau CarbuCORD 16 bar



Tubo CarbuCORD 16 bar

Ø OUTER Ø EXT.	Ø INNER Ø INT.	Part nº Referencia	€
42	30	M70003041	31,72
44	32	M70003243	33,46
55	40	M70004054	45,71
65	50	M70005064	49,35

## Manguera SAE 100 R4

SAE 100 R4 hose

Tuyau SAE 100 R4



Tubo R4 SAE 100

DN	Part nº Referencia	€
3/4"	ML701019	*
1"	ML701025	*
1 1/4"	ML701032	*
1 1/2"	ML701038	*
2"	ML701050	*
2 1/2"	ML701063	*

\*Ver precios en página 18 / \*See prices page 18 / \*Voir les prix page 18 / \*Vedere prezzi p.18

## Manguera EN 854 R6 / SAE 100 R6

EN 854 R6 / SAE 100 R6 Hose

Tuyau EN 854 R6 / SAE 100 R6



Tubo EN 854 R6 / SAE 100 R6

DN	Part nº Referencia	€
1/4"	MSB2104	*
5/16"	MSB2105	*
3/8"	MSB2106	*
1/2"	MSB2108	*
5/8"	MSB2110	*
3/4"	MSB2112	*
1"	MSB2116	*

\*Ver precios en página 18 / \*See prices page 18 / \*Voir les prix page 18 / \*Vedere prezzi p.18

# Manguera industrial INDUS<sup>Tr</sup>Δle

Industrial hoses INDUS<sup>Tr</sup>Δle  
Tuyaux industriels INDUS<sup>Tr</sup>Δle  
Tubi industriali INDUS<sup>Tr</sup>Δle

# INDUS<sup>Tr</sup>Δle<sup>®</sup>

Industrial hoses

Industrial fittings

Stainless steel hose, welding fittings and flanges

Low pressure

Air conditioning hoses and fittings

## Soldadura acetileno

*Welding hose acetylene*

Tuyau pour soudure - acetilène



*Tubo saldatura-acetilene*

Ø INNER Ø INT.	Ø outer Ø ext	Part n° Referencia	€
6,3	13,3	<b>MI06030603</b>	<b>2,83</b>
8	15	<b>MI06030803</b>	<b>3,47</b>
10	17	<b>MI06031003</b>	<b>3,76</b>

## Bitubo (soldadura) oxígeno-acetileno

*2 tubes welding hose - oxygene-acetylene*

Tuyau pour soudure jumelé - oxygène-acétylène



*Bitubo saldatura -ossigeno-acetilene*

Ø INNER Ø INT.	Ø outer Ø ext	Part n° Referencia	€
6,3-6,3	12,3-12,3	<b>MI0601060612</b>	<b>5,72</b>
8-8	14-14	<b>MI0601080814</b>	<b>6,30</b>
10-10	16-16	<b>MI0601101016</b>	<b>8,85</b>

## Soldadura oxígeno

*Welding hose - oxygene*

Tuyau pour soudure - oxygène



*Tubo saldatura-ossigeno*

Ø INNER Ø INT.	Ø outer Ø ext	Part n° Referencia	€
6,3	13,3	<b>MI06020603</b>	<b>2,83</b>
8	15	<b>MI06020803</b>	<b>3,47</b>
10	17	<b>MI06021003</b>	<b>3,76</b>

# Manguera industrial INDUSTrAle

Industrial hoses INDUSTrAle

Tuyaux industriels INDUSTrAle

Tubi industriali INDUSTrAle

# INDUS TrAle®

## Chorro de arena - impulsión 12 bar

Sandblast hose - delivery 12 bar

Tuyau sablage - refoulement 12 bar



Tubo scarico - sabbia 12 bar

Ø INNER Ø INT.	Ø outer Ø ext	Part n° Referencia	€
13	27	MI030112013	19,07
19	33	MI030112019	21,19
25	39	MI030112025	23,00
32	48	MI030112032	30,07
38	54	MI030112038	35,07
42	56	MI030112042	36,38

## Abrasiva 10 bar aspiración

Abrasive hose - suction 10 bar

Tuyau abrasif - aspiration 10 bar



Tubo abrasivo - aspirazione 10 bar

Ø INNER Ø INT.	Ø outer Ø ext	Part n° Referencia	€
51	65	MI030210051	62,39
60	75	MI030210060	72,54
63.5	79	MI030210063	69,30
76	92	MI030210076	100,34
80	96	MI030210080	104,13
102	118	MI030210102	138,29

## Productos químicos 16 bar EPDM

Chemical products hose 16 bar EPDM

Tuyau produits chimiques 16 bar EPDM



Tubo prodotti chimici 16 bar EPDM

Ø INNER Ø INT.	Ø outer Ø ext	Part n° Referencia	€
19	31	MI070116019	39,47
25	37	MI070116025	45,31
32	44	MI070116032	52,67
38	51	MI070116038	60,27
51	67	MI070116051	90,73
63	79	MI070116063	112,06

## Abrasiva 4 bar impulsión

Abrasive hose - delivery 4 bar

Tuyau abrasif - refoulement 4 bar



Tubo abrasivo - scarico 4 bar

Ø INNER Ø INT.	Ø outer Ø ext	Part n° Referencia	€
90	100	MI030305090	73,56
102	112	MI030305102	81,61
110	120	MI030305110	86,95
127	137	MI030305127	103,59
152	162	MI030305152	119,44
203	213	MI030305203	*

## Abrasiva impulsión 40 bar

Abrasive hose 40 bar

Tuyau abrasif 40 bar



Tubo abrasivo 40 bar

Ø INNER Ø INT.	Ø outer Ø ext	Part n° Referencia	€
25	37	MI030540025	28,14
32	46	MI030540032	35,31
35	49	MI030540035	38,72
38	54	MI030540038	45,13
50	66	MI030540050	59,75
65	83	MI030540065	80,61
76	98	MI030540076	138,85
102	125	MI030540102	195,60

## Productos químicos 16 bar Polietileno/UPE

Chemical products hose 16 bar Polyethylene /UPE

Tuyau produits chimiques 16 bar Polyéthylène / UPE



Prodotti chimici 16 bar Polietilene/UPE

Ø INNER Ø INT.	Ø outer Ø ext	Part n° Referencia	€
19	31	MI070216019	54,56
25	37	MI070216025	63,34
32	44	MI070216032	74,12
38	51	MI070216038	75,88
50	66	MI070216050	104,22
63	79	MI070216063	157,25
75	91	MI070216075	201,38
100	116	MI070216100	265,24

# Manguera industrial INDUSTrAle

Industrial hoses INDUSTrAle  
Tuyaux industriels INDUSTrAle  
Tubi industriali INDUSTrAle

# INDUS TrAle®

Industrial hoses

Industrial fittings

Stainless steel hose, welding fittings and flanges

Low pressure

Air conditioning hoses and fittings

## Manguera alimentaria polivalente FDA 10 bar

Multi-function food hose FDA 10 bar

Tuyau alimentaire polyvalent FDA 10 bar

Tubo alimentare polivalente FDA 10 bar



Ø INNER Ø INT.	Ø outer Ø ext	Part nº Referencia	€
25,4	38	<b>MAS025</b>	<b>43,83</b>
32	45	<b>MAS032</b>	<b>50,61</b>
38	52	<b>MAS038</b>	<b>56,03</b>
50,8	66	<b>MAS051</b>	<b>71,29</b>
63,5	78	<b>MAS063</b>	<b>100,45</b>
76,2	93	<b>MAS076</b>	<b>116,12</b>

## Leche anti-extrusión espiral poliamida 10 bar

Milk hose anti-extrusion polyamide spiral 10 bar

Tuyau à lait anti-extrusion spirale polyamide 10 bar

Tubo latte anti-estrusione spirale poliammide 10 bar



Ø INNER Ø INT.	Ø outer Ø ext	Part nº Referencia	€
25	38	<b>MI020510025</b>	<b>50,55</b>
32	45	<b>MI020510032</b>	<b>58,39</b>
38	52	<b>MI020510038</b>	<b>65,46</b>
51	66	<b>MI020510051</b>	<b>82,31</b>
63	78	<b>MI020510063</b>	<b>115,71</b>
76	93	<b>MI020510076</b>	<b>134,80</b>

## Bebidas alcohólicas máx. 40% FDA 10 bar

Alcoholic beverages max. 40% FDA 10 bar

Boissons alcoolisées max. 40% bar FDA 10

Bibite alcoliche max. 40% FDA 10 bar



Ø INNER Ø INT.	Ø outer Ø ext	Part nº Referencia	€
25	37	<b>MI020610025</b>	<b>44,19</b>
38	50	<b>MI020610038</b>	<b>63,69</b>
51	63	<b>MI020610051</b>	<b>75,88</b>
76	88	<b>MI020610076</b>	<b>116,89</b>



## RACORES INOX PARA INDUSTRIA ALIMENTARIA FOOD INDUSTRY STAINLESS STEEL FITTINGS

**SMS**  
**Tri-Clamp ISO 2852**  
**DIN 11851**  
**Macon**  
**PTFE STD Series**



Consulta en nuestra ficha técnica. Ver precios en Catálogo Racores Inox | Check our technical sheet for data options. See prices in Stainless Steel Fittings Catalogue

## Racores industriales

*Industrial fittings*

Raccords industriels

*Raccordi industriali*

<b>CAMLOCK DIN 2828</b>	138
<i>CAMLOCK DIN 2828 Fittings / Raccords CAMLOCK / Raccordi CAMLOCK</i>	
<b>Acoples GUILLEMIN NF E-29572</b>	144
<i>GUILLEMIN NF E-29572 Fittings / Raccords GUILLEMIN NF E-29572 / Raccordi GUILLEMIN NF E-29572</i>	
<b>Acoples TW DIN 28450</b>	146
<i>TW DIN 28450 Fittings / Raccords TW DIN 28450 / Raccordi TW DIN 28450</i>	
<b>Acople BARCELONA UNE 23400</b>	147
<i>BARCELONA UNE 23400 Fittings / Raccords BARCELONA UNE 23400 / Raccordi BARCELONA UNE 23400</i>	
<b>Acoples STORZ DIN 1430</b>	148
<i>STORZ DIN 1430 Fittings / Raccords STORZ DIN 1430 / Raccordi STORZ DIN 1430</i>	
<b>Acoples EA DIN 3489</b>	149
<i>EA DIN 3489 Fittings / Raccords EA DIN 3489 / Raccordi EA DIN 3489</i>	
<b>Acoples UA CHICAGO</b>	150
<i>UA CHICAGO Fittings / Raccords UA CHICAGO / Raccordi UA CHICAGO</i>	
<b>Acoples EXPRESS NF E-29-573</b>	151
<i>EXPRESS NF E-29-573 Fittings / Raccords EXPRESS NF E-29-573 / Raccordi EXPRESS NF E-29-573</i>	
<b>Acoples GEKA</b>	152
<i>GEKA Fittings / Raccords GEKA / Raccordi GEKA</i>	

# 2

## INDUG TrAle®

<b>Acoples CAMLOCK MORTERO</b>	153
<i>MORTAR CAMLOCK Fittings / Raccords MORTIER CAMLOCK / Raccordi CAMLOCK MORTAIO</i>	
<b>Acoples CHORRO DE ARENA</b>	154
<i>SANDBLAST Fittings / Raccords SABLAGE / Raccordi per SABBIATURA</i>	
<b>Acoples BAUER</b>	156
<i>BAUER Fittings / Raccords BAUER / Raccordi BAUER</i>	
<b>Acoples PERROT</b>	157
<i>PERROT Fittings / Raccords PERROT / Raccordi PERROT</i>	
<b>Acoples vapor tipo BOSS</b>	158
<i>Steam fittings BOSS type / Raccords vapeur type BOSS / Raccordi per vapore tipo BOSS</i>	
<b>Acoples vapor EN 14423</b>	159
<i>Steam EN 14423 fittings / Raccords vapeur EN 14423 / Raccordi per vapore EN 14423</i>	
<b>Accesorios industriales</b>	160
<i>Industrial accessories / Accessoires industriels / Accessori industriale</i>	

# CAMLOCK DIN 2828

CAMLOCK DIN 2828 Fittings  
Raccords CAMLOCK  
Raccordi CAMLOCK

■ CAMLOCK aluminio / CAMLOCK Unions aluminum / Raccords CAMLOCK aluminium / Raccordi CAMLOCK alluminio | 138



■ CAMLOCK latón / CAMLOCK Unions brass / Raccords CAMLOCK laiton / Raccordi CAMLOCK ottone | 140



■ CAMLOCK PP / CAMLOCK Unions PP / Raccords CAMLOCK PP / Raccordi CAMLOCK polipropilene | 142



■ Juntas CAMLOCK / CAMLOCK Seals / Joints CAMLOCK / Guarnizioni per Camlock | 143



## Acoples GUILLEMIN NF E-29572

*GUILLEMIN NF E-29572 Fittings*  
 Raccords GUILLEMIN NF E-29572  
 Raccordi GUILLEMIN NF E-29572

- GUILLEMIN aluminio / GUILLEMIN aluminum / GUILLEMIN aluminium / GUILLEMIN alluminio | 144



ALGU01C



ALGU02C



ALGU01S



ALGU02S



ALGU04C



ALGU03C



ALGU04S



ALGU05C

- Juntas para GUILLEMIN / Seals for GUILLEMIN / Joints pour GUILLEMIN / Guarnizioni per GUILLEMIN | 145



NBRGU

## Acoples TW DIN 28450

*TW DIN 28450 Fittings*  
 Raccords TW DIN 28450  
 Raccordi TW DIN 28450

- TW Latón / TW brass / TW laiton / TW Ottone | 146



BRMK



BRVK

- TW aluminio / TW aluminum / TW aluminium / TW alluminio | 146



ALMB/BRMB



ALVB/BRVB

## Acople BARCELONA UNE 23400

*BARCELONA UNE 23400 Fittings*  
 Raccords BARCELONA UNE 23400  
 Raccordi BARCELONA UNE 23400

- BARCELONA Aluminio / BARCELONA aluminium / BARCELONA aluminium / BARCELONA Alluminio | 147



ALBA01

ALBA03

ALBA05

ALBA02

ALBA04

- Juntas BARCELONA / BARCELONA seals / Joints BARCELONA / Guarnizioni BARCELONA | 147



NBRBA

## Acoples STORZ DIN 1430

*STORZ DIN 1430 Fittings*  
 Raccords STORZ DIN 1430  
 Raccordi STORZ DIN 1430

- STORZ aluminio DIN 1430 / STORZ aluminium DIN 1430 / STORZ aluminium DIN 1430 / STORZ alluminio DIN 1430 | 148



ALST01

ALST03

ALST05

ALST02

ALST04

- Juntas STORZ / STORZ Seals / STORZ Joints / Guarnizioni STORZ | 148



NBRST

## Acoples EA DIN 3489

EA DIN 3489 Fittings  
Raccords EA DIN 3489  
Raccordi EA DIN 3489

- EA acero / EA steel / EA acier / EA acciaio

| 149



EA01



EA02



EA04



EA05

- Juntas EA / EA seals / Joints EA / Guarnizioni EA

| 149



NBREA

## Acoples UA CHICAGO

UA CHICAGO Fittings  
Raccords UA CHICAGO  
Raccordi UA CHICAGO

- UA CHICAGO ACERO / UA CHICAGO steel / UA CHICAGO acier / UA CHICAGO acciaio

| 150



UA01



UA02



UA04



UA05

- JUNTAS UA CHICAGO / UA CHICAGO seals / Joints UA CHICAGO / Guarnizioni UA CHICAGO

| 150



NBRUA

## Acoples EXPRESS NF E-29-573

*EXPRESS NF E-29-573 Fittings*  
 Raccords EXPRESS NF E-29-573  
 Raccordi EXPRESS NF E-29-573

- EXPRESS latón / EXPRESS brass / EXPRESS laiton / EXPRESS ottone | 151



BREX01



BREX02



BREX04



BREX05

- Juntas EXPRESS / EXPRESS seals / Joints EXPRESS / Guarnizioni EXPRESS | 151



NBREX

## Acoples GEKA

*GEKA Fittings*  
 Raccords GEKA  
 Raccordi GEKA

- GEKA latón / GEKA brass / GEKA laiton / GEKA ottone | 152



BRGE01



BRGE02



BRGE04



BRGE05

- Juntas GEKA / GEKA seals / Joints GEKA / Guarnizioni GEKA | 152



NBRGE

## Acoples CAMLOCK MORTERO

*MORTAR CAMLOCK Fittings*  
 Raccords MORTIER CAMLOCK  
 Raccordi CAMLOCK MORTAIO

- CAMLOCK MORTERO acero carbono / Carbon steel MORTAR CAMLOCK / CAMLOCK MORTIER acier carbone / CAMLOCK MORTAIO acciaio al carbonio | 153



MT22A



MT22C



MT22D



MT22E

## Acoples CHORRO DE ARENA

SANDBLAST Fittings  
Raccords SABLAGE  
Raccordi per SABBIATURA

- CHORRO DE ARENA aluminio / SANDBLAST aluminum / SABLAGE aluminium / SABBIATURA alluminio | 154



ALCH05

ALCH01

ALCH07

- CHORRO DE ARENA latón / SANDBLAST brass / SABLAGE laiton / SABBIATURA ottone | 154



BRCH05

BRCH01

BRCH07

- CHORRO DE ARENA nylon / SANDBLAST nylon / SABLAGE nylon / SABBIATURA Nylon | 155



NYCH05

NYCH01

NYCH07

- Juntas CHORRO DE ARENA / SANDBLAST Seals / SABLAGE Joints / SABBIATURA Guarnizioni | 155



NBRCH

## Acoples BAUER

BAUER Fittings  
Raccords BAUER  
Raccordi BAUER

- BAUER acero / BAUER carbon steel / BAUER acier / BAUER acciaio | 156



BE

BEM

BEF

- JUNTA BAUER / BAUER seals / Joints BAUER / Guarnizioni BAUER | 156



NBRBE

## Acoples PERROT

*PERROT Fittings*  
*Raccords PERROT*  
*Raccordi PERROT*

- PERROT acero /PERROT carbon steel /PERROT acier /PERROT acciaio | 157



PE

PEM

PEF

- Juntas PERROT /PERROT seals / Joints PERROT /Guarnizioni PERROT | 157



NBRPE

## Acoples vapor tipo BOSS

*Steam fittings BOSS type*  
*Raccords vapeur type BOSS*  
*Raccordi per vapore tipo BOSS*

- BOSS acero /BOSS carbon steel /BOSS acier /BOSS acciaio | 158



B01\_3

## Acoples vapor EN 14423

*Steam EN 14423 fittings*  
*Raccords vapeur EN 14423*  
*Raccordi per vapore EN 14423*

- EN 144423 acero carbono /EN 14423 steel fittings /Raccords EN 14423 acier /Raccordi EN 14423 acciaio | 159



AB06



STE01



STE02

## Accesorios industriales

*Industrial accessories*  
*Accessoires industriels*  
*Accessori industriale*

- Campana para racor industrial / Crimping Ferrule for industrial fitting / Jupe pour raccord industriel / Boccia per raccordo industriale | 160



ALCA

- Abrazadera para racor industrial / Clamp for industrial fitting / Collier pour raccord industriel / Collare per raccordo industriale | 160



ALAB01



AB03



AB05



AB04



AB02

# CAMLOCK DIN 2828

CAMLOCK DIN 2828 Fittings  
Raccords CAMLOCK  
Raccordi CAMLOCK

## CAMLOCK aluminio macho - rosca hembra BSP Tipo A

CAMLOCK aluminum male - female threaded BSP A Type

CAMLOCK aluminium -adaptateur mâle - filetage femelle Type A

CAMLOCK alluminio -adattatore maschio-filettatura femmina Tipo A



DN	THREAD ROSCA	Part nº Referencia	€
12	1/2"	<b>ALA012</b>	<b>2,43</b>
20	3/4"	<b>ALA020</b>	<b>2,63</b>
25	1"	<b>ALA025</b>	<b>3,42</b>
32	1" 1/4	<b>ALA032</b>	<b>4,54</b>
40	1" 1/2	<b>ALA040</b>	<b>5,26</b>
50	2"	<b>ALA050</b>	<b>6,12</b>
65	2" 1/2	<b>ALA065</b>	<b>10,86</b>
80	3"	<b>ALA080</b>	<b>10,40</b>
100	4"	<b>ALA100</b>	<b>18,95</b>

## CAMLOCK aluminio hembra - rosca macho BSPT Tipo B

CAMLOCK aluminum female - male threaded BSPT B Type

CAMLOCK aluminium -adaptateur femelle - filetage mâle Type B

CAMLOCK alluminio -adattatore femmina-filettatura maschio Tipo B



DN	THREAD ROSCA	Part nº Referencia	€
12	1/2"	<b>ALB012</b>	<b>5,79</b>
20	3/4"	<b>ALB020</b>	<b>6,45</b>
25	1"	<b>ALB025</b>	<b>7,83</b>
32	1" 1/4	<b>ALB032</b>	<b>11,65</b>
40	1" 1/2	<b>ALB040</b>	<b>12,11</b>
50	2"	<b>ALB050</b>	<b>13,95</b>
65	2" 1/2	<b>ALB065</b>	<b>16,58</b>
80	3"	<b>ALB080</b>	<b>22,37</b>
100	4"	<b>ALB100</b>	<b>31,32</b>

## CAMLOCK aluminio hembra - para manguera Tipo C

CAMLOCK aluminum female - serrated hose shank C Type

CAMLOCK aluminium -coupleur femelle Type C

CAMLOCK alluminio -adattatore con inserto per tubo Tipo C



DN	THREAD ROSCA	Part nº Referencia	€
1/2"	12	<b>ALC012</b>	<b>5,79</b>
3/4"	20	<b>ALC020</b>	<b>6,45</b>
1"	25	<b>ALC025</b>	<b>8,09</b>
1"1/4	32	<b>ALC032</b>	<b>12,24</b>
1"1/2	40	<b>ALC040</b>	<b>13,16</b>
2"	50	<b>ALC050</b>	<b>16,38</b>
2"1/2	65	<b>ALC065</b>	<b>19,21</b>
3"	80	<b>ALC080</b>	<b>26,78</b>
4"	100	<b>ALC100</b>	<b>35,79</b>

## CAMLOCK aluminio hembra - rosca hembra BSP Tipo D

CAMLOCK aluminum female - female threaded BSP D Type

CAMLOCK aluminium -adaptateur femelle Type D

CAMLOCK alluminio -adattatore femmina Tipo D



DN	THREAD ROSCA	Part nº Referencia	€
12	1/2"	<b>ALD012</b>	<b>5,46</b>
20	3/4"	<b>ALD020</b>	<b>6,51</b>
25	1"	<b>ALD025</b>	<b>8,09</b>
32	1" 1/4	<b>ALD032</b>	<b>12,04</b>
40	1" 1/2	<b>ALD040</b>	<b>12,83</b>
50	2"	<b>ALD050</b>	<b>14,94</b>
65	2" 1/2	<b>ALD065</b>	<b>18,29</b>
80	3"	<b>ALD080</b>	<b>23,29</b>
100	4"	<b>ALD100</b>	<b>34,08</b>

## CAMLOCK aluminio macho - para manguera Tipo E

CAMLOCK aluminum male - serrated hose shank E Type

CAMLOCK aluminium -coupleur mâle Type E

CAMLOCK alluminio -adattatore con inserto per Tipo E



DN	THREAD ROSCA	Part nº Referencia	€
1/2"	12	<b>ALE012</b>	<b>2,57</b>
3/4"	20	<b>ALE020</b>	<b>2,83</b>
1"	25	<b>ALE025</b>	<b>3,88</b>
1"1/4	32	<b>ALE032</b>	<b>5,59</b>
1"1/2	40	<b>ALE040</b>	<b>6,65</b>
2"	50	<b>ALE050</b>	<b>8,95</b>
2"1/2	65	<b>ALE065</b>	<b>15,86</b>
3"	80	<b>ALE080</b>	<b>18,03</b>
4"	100	<b>ALE100</b>	<b>27,77</b>

## CAMLOCK aluminio macho - rosca macho BSPT Tipo F

CAMLOCK aluminum male - male threaded BSPT F Type

CAMLOCK aluminium -adaptateur mâle Type F

CAMLOCK alluminio -adattatore maschio Tipo F



DN	THREAD ROSCA	Part nº Referencia	€
12	1/2"	<b>ALF012</b>	<b>2,83</b>
20	3/4"	<b>ALF020</b>	<b>2,83</b>
25	1"	<b>ALF025</b>	<b>4,15</b>
32	1" 1/4	<b>ALF032</b>	<b>6,12</b>
40	1" 1/2	<b>ALF040</b>	<b>7,17</b>
50	2"	<b>ALF050</b>	<b>9,08</b>
65	2" 1/2	<b>ALF065</b>	<b>14,87</b>
80	3"	<b>ALF080</b>	<b>16,45</b>
100	4"	<b>ALF100</b>	<b>27,44</b>

# CAMLOCK DIN 2828

CAMLOCK DIN 2828 Fittings  
Raccords CAMLOCK  
Raccordi CAMLOCK

## CAMLOCK aluminio hembra - tapón Tipo DC

CAMLOCK aluminum cap DC Type

CAMLOCK aluminium -bouchon femelle Type DC

CAMLOCK alluminio -tappo di protezione Tipo DC



DN	Part nº Referencia	€
12	<b>ALDC012</b>	<b>5,40</b>
20	<b>ALDC020</b>	<b>6,12</b>
25	<b>ALDC025</b>	<b>7,37</b>
32	<b>ALDC032</b>	<b>10,72</b>
40	<b>ALDC040</b>	<b>11,45</b>
50	<b>ALDC050</b>	<b>13,36</b>
65	<b>ALDC065</b>	<b>15,26</b>
80	<b>ALDC080</b>	<b>20,27</b>
100	<b>ALDC100</b>	<b>29,15</b>

## CAMLOCK aluminio macho - tapón tipo DP

CAMLOCK aluminum male - plug DC Type

CAMLOCK aluminium -bouchon mâle Type DP

CAMLOCK alluminio -cappuccio di protezione  
Tipo DP



DN	Part nº Referencia	€
12	<b>ALDP012</b>	<b>1,58</b>
20	<b>ALDP020</b>	<b>2,24</b>
25	<b>ALDP025</b>	<b>2,83</b>
32	<b>ALDP032</b>	<b>4,21</b>
40	<b>ALDP040</b>	<b>4,74</b>
50	<b>ALDP050</b>	<b>6,84</b>
65	<b>ALDP065</b>	<b>9,47</b>
80	<b>ALDP080</b>	<b>10,79</b>
100	<b>ALDP100</b>	<b>18,23</b>

# CAMLOCK DIN 2828

CAMLOCK DIN 2828 Fittings  
Raccords CAMLOCK  
Raccordi CAMLOCK

## CAMLOCK latón macho - rosca hembra Tipo A

CAMLOCK brass - adaptor, female threaded A Type

CAMLOCK laiton - adaptateur mâle - filetage femelle Type A

CAMLOCK ottone - adattatore maschio-filettatura femmina Tipo A



DN	THREAD ROSCA	Part nº Referencia	€
12	1/2"	<b>BRA012</b>	<b>6,85</b>
20	3/4"	<b>BRA020</b>	<b>7,75</b>
25	1"	<b>BRA025</b>	<b>9,37</b>
32	1" 1/4	<b>BRA032</b>	<b>13,43</b>
40	1" 1/2	<b>BRA040</b>	<b>19,42</b>
50	2"	<b>BRA050</b>	<b>24,41</b>
65	2" 1/2	<b>BRA065</b>	<b>34,63</b>
80	3"	<b>BRA080</b>	<b>41,76</b>
100	4"	<b>BRA100</b>	<b>76,15</b>

## CAMLOCK latón hembra - rosca macho Tipo B

CAMLOCK brass - coupling, female threaded B Type

CAMLOCK laiton - adaptateur femelle - filetage mâle Type B

CAMLOCK ottone - adattatore femmina-filettatura maschio Tipo B



DN	THREAD ROSCA	Part nº Referencia	€
12	1/2"	<b>BRB012</b>	<b>15,59</b>
20	3/4"	<b>BRB020</b>	<b>13,27</b>
25	1"	<b>BRB025</b>	<b>18,53</b>
32	1" 1/4	<b>BRB032</b>	<b>27,83</b>
40	1" 1/2	<b>BRB040</b>	<b>32,41</b>
50	2"	<b>BRB050</b>	<b>38,70</b>
65	2" 1/2	<b>BRB065</b>	<b>49,57</b>
80	3"	<b>BRB080</b>	<b>69,06</b>
100	4"	<b>BRB100</b>	<b>96,41</b>

## CAMLOCK latón hembra para manguera Tipo C

CAMLOCK brass - coupling with serrated hose shank C Type

CAMLOCK laiton - coupleur femelle Type C

CAMLOCK ottone - adattatore con inserto per tubo Tipo C



DN	THREAD ROSCA	Part nº Referencia	€
1/2"	12	<b>BRC012</b>	<b>16,88</b>
3/4"	20	<b>BRC020</b>	<b>16,73</b>
1"	25	<b>BRC025</b>	<b>23,11</b>
1"1/4	32	<b>BRC032</b>	<b>34,77</b>
1"1/2	40	<b>BRC040</b>	<b>42,76</b>
2"	50	<b>BRC050</b>	<b>52,35</b>
2"1/2	65	<b>BRC065</b>	<b>71,95</b>
3"	80	<b>BRC080</b>	<b>96,87</b>
4"	100	<b>BRC100</b>	<b>158,97</b>

## CAMLOCK latón hembra BSP Tipo D

CAMLOCK brass - coupling, female threaded D Type

CAMLOCK laiton - adaptateur femelle Type D

CAMLOCK ottone - adattatore femmina Tipo D



DN	THREAD ROSCA	Part nº Referencia	€
12	1/2"	<b>BRD012</b>	<b>15,52</b>
20	3/4"	<b>BRD020</b>	<b>16,55</b>
25	1"	<b>BRD025</b>	<b>20,51</b>
32	1" 1/4	<b>BRD032</b>	<b>31,11</b>
40	1" 1/2	<b>BRD040</b>	<b>33,71</b>
50	2"	<b>BRD050</b>	<b>42,67</b>
65	2" 1/2	<b>BRD065</b>	<b>49,57</b>
80	3"	<b>BRD080</b>	<b>76,79</b>
100	4"	<b>BRD100</b>	<b>115,76</b>

## CAMLOCK latón macho para manguera Tipo E

CAMLOCK brass - adaptor, with serrated hose shank E Type

CAMLOCK laiton - coupleur mâle Type E

CAMLOCK ottone - adattatore con inserto per Tipo E



DN	THREAD ROSCA	Part nº Referencia	€
1/2"	12	<b>BRE012</b>	<b>9,85</b>
3/4"	20	<b>BRE020</b>	<b>11,36</b>
1"	25	<b>BRE025</b>	<b>17,43</b>
1"1/4	32	<b>BRE032</b>	<b>23,41</b>
1"1/2	40	<b>BRE040</b>	<b>32,78</b>
2"	50	<b>BRE050</b>	<b>41,76</b>
2"1/2	65	<b>BRE065</b>	<b>66,78</b>
3"	80	<b>BRE080</b>	<b>96,87</b>
4"	100	<b>BRE100</b>	<b>160,28</b>

## CAMLOCK latón macho BSPT Tipo F

CAMLOCK brass - adaptor, male threaded F Type

CAMLOCK laiton - adaptateur mâle Type F

CAMLOCK ottone - adattatore maschio Tipo F



DN	THREAD ROSCA	Part nº Referencia	€
12	1/2"	<b>BRF012</b>	<b>8,37</b>
20	3/4"	<b>BRF020</b>	<b>9,37</b>
25	1"	<b>BRF025</b>	<b>12,05</b>
32	1" 1/4	<b>BRF032</b>	<b>19,04</b>
40	1" 1/2	<b>BRF040</b>	<b>23,11</b>
50	2"	<b>BRF050</b>	<b>32,39</b>
65	2" 1/2	<b>BRF065</b>	<b>48,05</b>
80	3"	<b>BRF080</b>	<b>65,80</b>
100	4"	<b>BRF100</b>	<b>101,63</b>

# CAMLOCK DIN 2828

CAMLOCK DIN 2828 Fittings  
Raccords CAMLOCK  
Raccordi CAMLOCK

## CAMLOCK latón hembra -tapón Tipo DC

CAMLOCK brass - cap DC Type

CAMLOCK laiton -bouchon femelle Type DC

CAMLOCK ottone -tappo di protezione Tipo DC



DN		Part nº Referencia	€
1/2"	12	<b>BRDC012</b>	<b>12,98</b>
3/4"	20	<b>BRDC020</b>	<b>14,74</b>
1"	25	<b>BRDC025</b>	<b>18,73</b>
1"1/4	32	<b>BRDC032</b>	<b>29,40</b>
1"1/2	40	<b>BRDC040</b>	<b>32,78</b>
2"	50	<b>BRDC050</b>	<b>41,45</b>
2"1/2	65	<b>BRDC065</b>	<b>52,86</b>
3"	80	<b>BRDC080</b>	<b>62,79</b>
4"	100	<b>BRDC100</b>	<b>90,19</b>

## CAMLOCK latón macho -tapón Tipo DP

CAMLOCK brass - plug DP Type

CAMLOCK laiton -bouchon mâle Type DP

CAMLOCK ottone -cappuccio di protezione Tipo DP



DN		Part nº Referencia	€
1/2"	12	<b>BRDP012</b>	<b>5,56</b>
3/4"	20	<b>BRDP020</b>	<b>5,76</b>
1"	25	<b>BRDP025</b>	<b>8,75</b>
1"1/4	32	<b>BRDP032</b>	<b>13,36</b>
1"1/2	40	<b>BRDP040</b>	<b>16,73</b>
2"	50	<b>BRDP050</b>	<b>26,71</b>
2"1/2	65	<b>BRDP065</b>	<b>36,54</b>
3"	80	<b>BRDP080</b>	<b>55,34</b>
4"	100	<b>BRDP100</b>	<b>75,99</b>

# CAMLOCK DIN 2828

CAMLOCK DIN 2828 Fittings  
Raccords CAMLOCK  
Raccordi CAMLOCK

## CAMLOCK PP Adaptador macho - rosca hembra Tipo A BSP

CAMLOCK PP-Adaptor, female threaded A Type BSP

CAMLOCK PP-Adaptateur mâle - filetage femelle Type A BSP

CAMLOCK PP-Adattatore maschio-filettatura femmina Tipo A BSP



DN	THREAD ROSCA	Part nº Referencia	€
12	1/2"	PPA012	0,92
20	3/4"	PPA020	0,97
25	1"	PPA025	1,08
32	1"1/4"	PPA032	1,60
40	1"1/2"	PPA040	1,86
50	2"	PPA050	2,99
65	2"1/2"	PPA065	3,79
80	3"	PPA080	4,72
100	4"	PPA100	11,75

## CAMLOCK PP Adaptador hembra - rosca macho Tipo B BSPT

CAMLOCK PP-Coupling, female threaded B Type BSPT

CAMLOCK PP-Adaptateur femelle - filetage mâle Type B BSPT

CAMLOCK PP-Adattatore femmina-filettatura maschio Tipo B BSPT



DN	THREAD ROSCA	Part nº Referencia	€
12	1/2"	PPB012	4,95
20	3/4"	PPB020	5,12
25	1"	PPB025	6,17
32	1"1/4"	PPB032	9,24
40	1"1/2"	PPB040	9,53
50	2"	PPB050	10,19
65	2"1/2"	PPB065	12,13
80	3"	PPB080	14,79
100	4"	PPB100	29,33

## CAMLOCK PP Conexión hembra para manguera Tipo C

CAMLOCK PP-Coupling with serrated hose shank C Type

CAMLOCK PP-Coupleur femelle Type C

CAMLOCK PP-Adattatore con inserto per tubo Tipo C



DN	THREAD ROSCA	Part nº Referencia	€
12	1/2"	PPC012	5,07
20	3/4"	PPC020	5,24
25	1"	PPC025	6,13
32	1"1/4"	PPC032	9,36
40	1"1/2"	PPC040	9,58
50	2"	PPC050	10,82
65	2"1/2"	PPC065	13,36
80	3"	PPC080	16,16
100	4"	PPC100	31,80

## CAMLOCK PP Adaptador hembra Tipo D BSP

CAMLOCK PP-Coupling, female threaded D Type BSP

CAMLOCK PP-Adaptateur femelle Type D BSP

CAMLOCK PP-Adattatore femmina Tipo D BSP



DN	THREAD ROSCA	Part nº Referencia	€
12	1/2"	PPD012	4,86
20	3/4"	PPD020	4,80
25	1"	PPD025	5,75
32	1"1/4"	PPD032	9,10
40	1"1/2"	PPD040	9,64
50	2"	PPD050	10,31
65	2"1/2"	PPD065	10,87
80	3"	PPD080	14,19
100	4"	PPD100	30,85

## CAMLOCK PP Conexión macho para manguera Tipo E

CAMLOCK PP-Adaptor, with serrated hose shank E Type

CAMLOCK PP-Coupleur mâle Type E

CAMLOCK PP-Adattatore con inserto per Tipo E



DN	THREAD ROSCA	Part nº Referencia	€
12	1/2"	PPE012	0,90
20	3/4"	PPE020	1,08
25	1"	PPE025	1,20
32	1"1/4"	PPE032	1,70
40	1"1/2"	PPE040	3,10
50	2"	PPE050	3,71
65	2"1/2"	PPE065	4,64
80	3"	PPE080	6,44
100	4"	PPE100	14,15

## CAMLOCK PP Adaptador macho Tipo F BSPT

CAMLOCK PP-Adaptor, male threaded F Type BSPT

CAMLOCK PP-Adaptateur mâle Type F BSPT

CAMLOCK PP-Adattatore maschio Tipo F BSPT



DN	THREAD ROSCA	Part nº Referencia	€
12	1/2"	PPF012	0,97
20	3/4"	PPF020	1,15
25	1"	PPF025	1,18
32	1"1/4"	PPF032	1,74
40	1"1/2"	PPF040	1,93
50	2"	PPF050	3,31
65	2"1/2"	PPF065	4,37
80	3"	PPF080	5,09
100	4"	PPF100	13,49

# CAMLOCK DIN 2828

CAMLOCK DIN 2828 Fittings  
Raccords CAMLOCK  
Raccordi CAMLOCK

## CAMLOCK PP Tapón hembra Tipo DC

CAMLOCK PP-Caps DC Type

CAMLOCK PP-Bouchon femelle Type DC

CAMLOCK PP-Tappo di protezione Tipo DC



DN	THREAD ROSCA	Part nº Referencia	€
12	1/2"	PPDC012	3,54
20	3/4"	PPDC020	4,45
25	1"	PPDC025	5,64
32	1"1/4"	PPDC032	8,69
40	1"1/2"	PPDC040	9,49
50	2"	PPDC050	9,83
65	2"1/2"	PPDC065	12,28
80	3"	PPDC080	13,90
100	4"	PPDC100	28,20

## CAMLOCK PP Tapón macho tipo DP

CAMLOCK PP-Plug DP Type

CAMLOCK PP-Bouchon mâle Type DP

CAMLOCK PP-Cappuccio di protezione Tipo DP



DN	THREAD ROSCA	Part nº Referencia	€
12	1/2"	PPDP012	0,96
20	3/4"	PPDP020	0,96
25	1"	PPDP025	1,12
32	1"1/4"	PPDP032	1,66
40	1"1/2"	PPDP040	1,88
50	2"	PPDP050	2,19
65	2"1/2"	PPDP065	3,58
80	3"	PPDP080	4,83
100	4"	PPDP100	10,25

## Juntas CAMLOCK NBR

CAMLOCK NBR Seal

Joint CAMLOCK NBR

Guarnizione in NBR per CAMLOCK



DN	Part nº Referencia	€
12	JCAMNBR012	*
20	JCAMNBR020	*
25	JCAMNBR025	*
32	JCAMNBR032	*
40	JCAMNBR040	*
50	JCAMNBR050	*
65	JCAMNBR065	*
80	JCAMNBR080	*
100	JCAMNBR100	*

\*Ver precios en Tarifa Inox pág. 198 / \*See prices in Stainless steel Catalogue p. 198 / \*Voir prix dans le Catalogue Acier Inox p. 198 / \*Prezzi in Acciaio Inossidabile p. 198

## Junta CAMLOCK silicona

CAMLOCK Silicone Seal

Joint CAMLOCK silicone

Guarnizione in silicone per CAMLOCK



DN	Part nº Referencia	€
12	JCAMS012	*
20	JCAMS020	*
25	JCAMS025	*
32	JCAMS032	*
40	JCAMS040	*
50	JCAMS050	*
65	JCAMS065	*
80	JCAMS080	*
100	JCAMS100	*

\*Ver precios en Tarifa Inox pág. 198 / \*See prices in Stainless steel Catalogue p. 198 / \*Voir prix dans le Catalogue Acier Inox p. 198 / \*Prezzi in Acciaio Inossidabile p. 198

## CAMLOCK ACERO INOXIDABLE | STAINLESS STEEL



### EN 14420-7 | DIN 2828

Ver ficha técnica | Check technical sheet

Para una amplia gama de aplicaciones como agua, petróleo y productos químicos  
For a wide range of applications such as water, petroleum and chemical liquids

# Acoples GUILLEMIN NF E-29572

GUILLEMIN NF E-29572 Fittings  
Raccords GUILLEMIN NF E-29572  
Raccordi GUILLEMIN NF E-29572

## GUILLEMIN aluminio con cierre -rosca hembra BSP

GUILLEMIN aluminium with closure-BSP Female thread

GUILLEMIN aluminium avec fermeture-Filetage Femelle BSP

GUILLEMIN alluminio con chiusura-Filetto femmina



DN	THREAD ROSCA	Part n° Referencia	€
20	3/4"	ALGU01C020	8,55
25	1"	ALGU01C025	11,81
32	1" 1/4	ALGU01C032	13,83
40	1" 1/2	ALGU01C040	17,29
50	2"	ALGU01C050	25,50
65	2" 1/2	ALGU01C065	31,90
80	3"	ALGU01C080	35,72
100	4"	ALGU01C100	61,47

## GUILLEMIN aluminio con cierre -rosca macho BSP

GUILLEMIN aluminium with closure-BSP Male thread

GUILLEMIN aluminium avec fermeture-Filetage Male BSP

GUILLEMIN alluminio con chiusura-Filetto maschio



DN	THREAD ROSCA	Part n° Referencia	€
20	3/4"	ALGU02C020	8,94
25	1"	ALGU02C025	8,94
32	1" 1/4	ALGU02C032	14,48
40	1" 1/2	ALGU02C040	11,35
50	2"	ALGU02C050	18,47
65	2" 1/2	ALGU02C065	20,48
80	3"	ALGU02C080	34,47
100	4"	ALGU02C100	37,18

## GUILLEMIN aluminio sin cierre -rosca hembra BSP

GUILLEMIN aluminium without closure-BSP Female thread

GUILLEMIN aluminium sans fermeture-Filetage Femelle BSP

GUILLEMIN alluminio senza chiusura-Filetto femmina



DN	THREAD ROSCA	Part n° Referencia	€
20	3/4"	ALGU01S020	8,15
25	1"	ALGU01S025	8,15
32	1" 1/4	ALGU01S032	8,87
40	1" 1/2	ALGU01S040	6,86
50	2"	ALGU01S050	9,58
65	2" 1/2	ALGU01S065	11,14
80	3"	ALGU01S080	16,68
100	4"	ALGU01S100	20,23

## GUILLEMIN aluminio sin cierre -rosca macho BSP

GUILLEMIN aluminium without closure-BSP Male thread

GUILLEMIN aluminium sans fermeture-Filetage Male BSP

GUILLEMIN alluminio senza chiusura-Filetto maschio



DN	THREAD ROSCA	Part n° Referencia	€
20	3/4"	ALGU02S020	8,15
25	1"	ALGU02S025	8,15
32	1" 1/4	ALGU02S032	9,46
40	1" 1/2	ALGU02S040	8,81
50	2"	ALGU02S050	11,61
65	2" 1/2	ALGU02S065	15,52
80	3"	ALGU02S080	22,44
100	4"	ALGU02S100	29,09

## GUILLEMIN aluminio con cierre -tapón

GUILLEMIN aluminium with closure-Plug

GUILLEMIN aluminium avec fermeture-Bouchon

GUILLEMIN alluminio con chiusura-Tappo



DN	Part n° Referencia	€
20	ALGU04C020	10,50
25	ALGU04C025	10,50
32	ALGU04C032	10,50
40	ALGU04C040	12,20
50	ALGU04C050	16,11
65	ALGU04C065	19,24
80	ALGU04C080	27,14
100	ALGU04C100	34,05

## GUILLEMIN aluminio con cierre-reductor

GUILLEMIN aluminium with closure-Reducer

GUILLEMIN aluminium avec fermeture-Réduction

GUILLEMIN alluminio con chiusura-Riduzione



DN	Part n° Referencia	€
40-32	ALGU03C040032	45,79
50-40	ALGU03C050040	40,32
65-50	ALGU03C065050	43,44
80-65	ALGU03C080065	59,88
100-80	ALGU03C100080	88,52

## GUILLEMIN aluminio sin cierre -tapón

GUILLEMIN aluminium without closure-Plug

GUILLEMIN aluminium sans fermeture-Bouchon

GUILLEMIN alluminio senza chiusura-Tappo



DN	Part n° Referencia	€
32	ALGU04S032	12,00
40	ALGU04S040	12,00
50	ALGU04S050	11,09
65	ALGU04S065	17,03
80	ALGU04S080	17,68
100	ALGU04S100	23,94

# Acoples GUILLEMIN NF E-29572

GUILLEMIN NF E-29572 Fittings  
Raccords GUILLEMIN NF E-29572  
Raccordi GUILLEMIN NF E-29572

## GUILLEMIN aluminio con cierre -para manguera

GUILLEMIN aluminium with closure-For hose

GUILLEMIN aluminium avec fermeture-Pour tuyau

GUILLEMIN alluminio con chiusura-Per tubo



L (mm)	SIZE TAMAÑO	Part nº Referencia	€
37	40	<b>ALGU05C040040</b>	<b>15,22</b>
37	40	<b>ALGU05C040045</b>	<b>15,22</b>
50	50	<b>ALGU05C050050</b>	<b>21,36</b>
50	50	<b>ALGU05C050055</b>	<b>18,79</b>
50	65	<b>ALGU05C065065</b>	<b>27,07</b>
70	80	<b>ALGU05C080080</b>	<b>34,57</b>
97	100	<b>ALGU05C100100</b>	<b>52,18</b>

## GUILLEMIN -junta NBR

GUILLEMIN -NBR joint

GUILLEMIN -joint NBR

GUILLEMIN -Guarnizioni NBR



DN	SIZE TAMAÑO	Part nº Referencia	€
20	3/4"	<b>NBRGU020</b>	<b>0,39</b>
25	1"	<b>NBRGU025</b>	<b>0,65</b>
32	1"1/4	<b>NBRGU032</b>	<b>0,72</b>
40	1"1/2	<b>NBRGU040</b>	<b>1,24</b>
50	2"	<b>NBRGU050</b>	<b>1,30</b>
65	2"1/2	<b>NBRGU065</b>	<b>2,35</b>
80	3"	<b>NBRGU080</b>	<b>2,67</b>
100	4"	<b>NBRGU100</b>	<b>5,41</b>

## GUILLEMIN ACERO INOXIDABLE | STAINLESS STEEL



**EN 14420-8 | NF E-29572**

Ver ficha técnica | Check technical sheet

Aplicaciones de presión y aspiración en un amplio rango de industrias

Pressure and suction purposes in a wide range of industries

# Acoples TW DIN 28450

TW DIN 28450 Fittings  
Raccords TW DIN 28450  
Raccordi TW DIN 28450

## TW latón -Rosca hembra - acople hembra BSP

*TW brass -Female thread - female coupling*

*TW laiton -Filetage Femelle - accouplement Femelle BSP*

*TW ottone -Filetto femmina- accoppiamento femmina BSP*



DN	Part nº Referencia	€
2"	<b>BRMK05032</b>	<b>58,64</b>
3"	<b>BRMK08048</b>	<b>110,89</b>
4"	<b>BRMK10064</b>	<b>221,25</b>

## TW latón -Rosca hembra - acople macho BSP

*TW brass -Female thread - male coupling*

*TW laiton - Filetage Femelle - accouplement Male BSP*

*TW ottone -Filetto femmina- accoppiamento maschio BSP*



DN	Ø	Part nº Referencia	€
2"	70.5	<b>BRVK05032</b>	<b>23,61</b>
3"	102	<b>BRVK08048</b>	<b>55,51</b>
4"	128	<b>BRVK10064</b>	<b>83,36</b>

## TW aluminio-Tapón - acople hembra

*TW aluminum -Female Dust Cap coupling*

*TW aluminium -Bouchon - accouplement Femelle*

*TW alluminio -Tappo- accoppiamento femmina*



DN	Part nº Referencia	€	Part Nº STA Referencia STA	€
2"	<b>ALMB050</b>	<b>11,35</b>	<b>BRMB050</b>	<b>18,98</b>
3"	<b>ALMB080</b>	<b>22,77</b>	<b>BRMB080</b>	<b>54,01</b>
4"	<b>ALMB100</b>	<b>47,75</b>	<b>BRMB100</b>	<b>92,82</b>

## TW aluminio-Tapón - acople macho

*TW aluminum - Male Dust Plug coupling*

*TW aluminium -Bouchon - accouplement Mâle*

*TW alluminio -Tappo- accoppiamento maschio*



DN	Ø	Part nº Referencia	€	Part Nº STA Referencia STA	€
2"	70.5	<b>ALVB050</b>	<b>8,35</b>	<b>BRVB050</b>	<b>18,72</b>
3"	102	<b>ALVB080</b>	<b>16,05</b>	<b>BRVB080</b>	<b>48,92</b>
4"	128	<b>ALVB100</b>	<b>32,35</b>	<b>BRVB100</b>	<b>71,75</b>

# Acople BARCELONA UNE 23400

BARCELONA UNE 23400 Fittings  
Raccords BARCELONA UNE 23400  
Raccordi BARCELONA UNE 23400

## BARCELONA aluminio -Rosca hembra BSP

BARCELONA aluminium- Female thread BSP

BARCELONA aluminium- Filetage femelle BSP

BARCELONA Alluminio- Filetto femmina BSP



THREAD ROSCA	SIZE TAMAÑO	Part nº Referencia	€
1"	DN 25	<b>ALBA0102516</b>	<b>11,39</b>
1" 1/2	DN 45	<b>ALBA0104524</b>	<b>17,83</b>
2" 1/2	DN 70	<b>ALBA0107040</b>	<b>34,57</b>

## BARCELONA aluminio -Reductor

BARCELONA aluminium- Reducer

BARCELONA aluminium- Reducteur

BARCELONA Alluminio- Riduttore



SIZE TAMAÑO	Part nº Referencia	€
70-45	<b>ALBA03070045</b>	<b>72,34</b>
45-25	<b>ALBA03045025</b>	<b>37,57</b>

## BARCELONA aluminio -Para manguera

BARCELONA aluminium- For hose

BARCELONA aluminium- Pour tuyau

BARCELONA Alluminio- Per tubo



DN	Part nº Referencia	€
25	<b>ALBA05025025</b>	<b>18,03</b>
45	<b>ALBA05045045</b>	<b>29,69</b>
70	<b>ALBA05070070</b>	<b>50,97</b>

## Juntas NBR BARCELONA

NBR BARCELONA seals

Joints NBR BARCELONA

Guarnizioni NBR BARCELONA



DN	Part nº Referencia	€
25	<b>NBRBA025</b>	<b>0,61</b>
45	<b>NBRBA045</b>	<b>0,91</b>
70	<b>NBRBA070</b>	<b>1,52</b>

## BARCELONA aluminio -Rosca macho BSP

BARCELONA aluminium- Male thread BSP

BARCELONA aluminium- Filetage mâle BSP

BARCELONA Alluminio- Filetto maschio BSP



THREAD ROSCA	SIZE TAMAÑO	Part nº Referencia	€
1"	25	<b>ALBA0202516</b>	<b>10,85</b>
1" 1/2	45	<b>ALBA0204524</b>	<b>19,86</b>
2" 1/2	70	<b>ALBA0207040</b>	<b>41,08</b>

## BARCELONA aluminio -Tapón

BARCELONA aluminium- Dust Cap

BARCELONA aluminium- Bouchon

BARCELONA Alluminio- Tappo



SIZE TAMAÑO	Part nº Referencia	€
25	<b>ALBA04025</b>	<b>10,76</b>
45	<b>ALBA04045</b>	<b>13,44</b>
70	<b>ALBA04070</b>	<b>25,63</b>

# Acoples STORZ DIN 1430

STORZ DIN 1430 Fittings  
Raccords STORZ DIN 1430  
Raccordi STORZ DIN 1430

## STORZ aluminio- Rosca hembra BSP

STORZ aluminium- Female thread BSP

STORZ aluminium- Filetage femelle BSP

STORZ Alluminio- Filetto femmina BSP



DN	THREAD ROSCA	Part nº Referencia	€
25	1"	<b>ALST01025D16</b>	<b>18,00</b>
38	1"1/2	<b>ALST0103824</b>	<b>18,59</b>
52	2"	<b>ALST01052C32</b>	<b>16,63</b>
65	2"1/2	<b>ALST0106540</b>	<b>36,40</b>
75	3"	<b>ALST01075B48</b>	<b>32,57</b>
110	4"	<b>ALST01110A64</b>	<b>74,11</b>

## STORZ aluminio- Reductor

STORZ aluminium- Reducer

STORZ aluminium- Reducteur

STORZ Alluminio- Riduttore



DN	Part nº Referencia	€
25-52	<b>ALST03052C025D</b>	<b>48,99</b>
52-75	<b>ALST03075B052C</b>	<b>64,25</b>
65-110	<b>ALST03110A065</b>	<b>150,61</b>
75-110	<b>ALST03110A075B</b>	<b>129,54</b>

## STORZ aluminio- Para manguera

STORZ aluminium- For hose

STORZ aluminium- Pour tuyau

STORZ Alluminio- Per tubo



DN	Part nº Referencia	€
25	<b>ALST05025D</b>	<b>13,05</b>
38	<b>ALST05038038</b>	<b>21,40</b>
52	<b>ALST05052C052</b>	<b>19,83</b>
65	<b>ALST05065065</b>	<b>37,18</b>
75	<b>ALST05075B075</b>	<b>36,15</b>
100	<b>ALST05110A100</b>	<b>75,95</b>

## Juntas NBR STORZ

STORZ - NBR Seals

Joints STORZ - NBR

STORZ - Guarnizioni NBR



DN	Part nº Referencia	€
25	<b>NBRST025D</b>	<b>0,38</b>
38	<b>NBRST038</b>	<b>0,53</b>
52	<b>NBRST052C</b>	<b>0,69</b>
65	<b>NBRST065</b>	<b>1,14</b>
75	<b>NBRST075B</b>	<b>1,52</b>
100	<b>NBRST110A</b>	<b>4,19</b>

## STORZ aluminio- Rosca macho BSP

STORZ aluminium- Male thread BSP

STORZ aluminium- Filetage mâle BSP

STORZ Alluminio- Filetto maschio BSP



DN	THREAD ROSCA	Part nº Referencia	€
25	1"	<b>ALST02025D16</b>	<b>20,74</b>
	1"1/2	<b>ALST0203820</b>	<b>27,01</b>
52	2"	<b>ALST02052C32</b>	<b>18,39</b>
65	2"1/2	<b>ALST0206540</b>	<b>36,40</b>
75	3"	<b>ALST02075B48</b>	<b>36,14</b>
110	4"	<b>ALST02110A64</b>	<b>73,77</b>

## STORZ aluminio- Tapón

STORZ aluminium- Cap

STORZ aluminium- Bouchon

STORZ Alluminio- Tappo



DN	Part nº Referencia	€
25	<b>ALST04025D</b>	<b>18,59</b>
38	<b>ALST04038</b>	<b>28,44</b>
52	<b>ALST04052C</b>	<b>20,87</b>
65	<b>ALST04065</b>	<b>35,68</b>
75	<b>ALST04075B</b>	<b>33,20</b>
100	<b>ALST04110A</b>	<b>72,60</b>

# Acoples EA DIN 3489

EA DIN 3489 Fittings  
Raccords EA DIN 3489  
Raccordi EA DIN 3489

Industrial hoses

Industrial fittings

Stainless steel hose, welding fittings and flanges

Low pressure

Air conditioning hoses and fittings

## EA acero- Rosca hembra BSP

EA steel- Female thread BSP

EA acier- Filetage femelle BSP

EA acciaio - Filetto femmina BSP



THREAD ROSCA	Part n° Referencia	€
1/2"	<b>EA0108</b>	<b>3,85</b>
3/4"	<b>EA0112</b>	<b>4,31</b>
1"	<b>EA0116</b>	<b>4,63</b>

## EA acero- Rosca macho BSP

EA steel- Male thread BSP

EA acier- Filetage mâle BSP

EA acciaio - Filetto maschio BSP



THREAD ROSCA	Part n° Referencia	€
1/2"	<b>EA0208</b>	<b>4,50</b>
3/4"	<b>EA0212</b>	<b>4,63</b>
1"	<b>EA0216</b>	<b>5,48</b>

## Juntas NBR EA

EA NBR seals

Joints NBR EA

Guarnizioni EA NBR



DN	Part n° Referencia	€
for all sizes	<b>NBREA</b>	<b>0,42</b>

## EA acero- Tapón

EA steel- Cap

EA acier- Bouchon

EA acciaio - Tappo



DESCRIPTION DESCRIPCIÓN	Part n° Referencia	€
Tapón	<b>EA04</b>	<b>4,44</b>

## EA acero- Para manguera c/collar

EA steel- For hose

EA acier- Pour tuyau avec collier

EA acciaio - Per tubo



DN	Part n° Referencia	€
13	<b>EA0513</b>	<b>4,63</b>
16	<b>EA0516</b>	<b>4,89</b>
19	<b>EA0519</b>	<b>4,89</b>
25	<b>EA0525</b>	<b>5,74</b>

# Acoples UA CHICAGO

UA CHICAGO Fittings  
Raccords UA CHICAGO  
Raccordi UA CHICAGO

## UA CHICAGO acero- Rosca hembra NPT

UA CHICAGO steel- Female thread NPT

UA CHICAGO acier- Filetage femelle NPT

UA CHICAGO acciaio - Filetto femmina NPT



THREAD ROSCA	Part n° Referencia	€
1/4" NPT	<b>UA0104</b>	<b>4,50</b>
3/8" NPT	<b>UA0106</b>	<b>4,50</b>
1/2" NPT	<b>UA0108</b>	<b>4,70</b>
3/4" NPT	<b>UA0112</b>	<b>4,96</b>
1" NPT	<b>UA0116</b>	<b>5,94</b>
1" 1/4 NPT	<b>UA0120</b>	<b>18,26</b>
1" 1/2 NPT	<b>UA0124</b>	<b>19,31</b>
2" NPT	<b>UA0132</b>	<b>19,77</b>

## UA CHICAGO acero- Rosca macho NPT

UA CHICAGO steel- Male thread NPT

UA CHICAGO acier- Filetage mâle NPT

UA CHICAGO acciaio - Filetto maschio NPT



THREAD ROSCA	Part n° Referencia	€
1/4" NPT	<b>UA0204</b>	<b>4,63</b>
3/8" NPT	<b>UA0206</b>	<b>4,63</b>
1/2" NPT	<b>UA0208</b>	<b>4,83</b>
3/4" NPT	<b>UA0212</b>	<b>5,28</b>
1" NPT	<b>UA0216</b>	<b>6,33</b>
1 1/4" NPT	<b>UA0220</b>	<b>24,00</b>
1 1/2" NPT	<b>UA0224</b>	<b>25,57</b>
2" NPT	<b>UA0232</b>	<b>26,68</b>

## NBR JUNTAS UA CHICAGO

UA CHICAGO NBR seals

Joints NBR UA CHICAGO

Guarnizioni UA CHICAGO NBR



DN	Part n° Referencia	€
for all sizes	<b>NBRUA02</b>	<b>0,46</b>

## UA CHICAGO acero- Tapón

UA CHICAGO steel- Cap

UA CHICAGO acier- Bouchon

UA CHICAGO acciaio - Tappo



Part n° Referencia	€
<b>UA0402</b>	<b>5,68</b>

## UA CHICAGO acero- Para manguera c/collar

UA CHICAGO steel- For hose

UA CHICAGO acier- Pour tuyau avec collier

UA CHICAGO acciaio - Per tubo



DN	Part n° Referencia	€
7	<b>UA0507</b>	<b>5,87</b>
10	<b>UA0510</b>	<b>4,83</b>
13	<b>UA0513</b>	<b>5,22</b>
19	<b>UA0519</b>	<b>5,35</b>
25	<b>UA0525</b>	<b>6,13</b>
32	<b>UA0532</b>	<b>18,98</b>
38	<b>UA0538</b>	<b>20,29</b>
50	<b>UA0550</b>	<b>25,63</b>

# Acoples EXPRESS NF E-29-573

EXPRESS NF E-29-573 Fittings  
Raccords EXPRESS NF E-29-573  
Raccordi EXPRESS NF E-29-573

Industrial hoses

Industrial fittings

Stainless steel hose, welding fittings and flanges

Low pressure

Air conditioning hoses and fittings

## EXPRESS latón- Rosca hembra BSP

EXPRESS brass- Female thread BSP

EXPRESS laiton- Filetage femelle BSP

EXPRESS ottone - Filetto femmina BSP



THREAD ROSCA	Part nº Referencia	€
1/4"	<b>BREX0104</b>	<b>5,48</b>
3/8"	<b>BREX0106</b>	<b>5,48</b>
1/2"	<b>BREX0108</b>	<b>5,74</b>
3/4"	<b>BREX0112</b>	<b>6,26</b>
1"	<b>BREX0116</b>	<b>6,26</b>
1" 1/4	<b>BREX0120</b>	<b>9,00</b>

## EXPRESS latón- Rosca macho BSP

EXPRESS brass- Male thread BSP

EXPRESS laiton- Filetage mâle BSP

EXPRESS ottone - Filetto maschio BSP



THREAD ROSCA	Part nº Referencia	€
1/4"	<b>BREX0204</b>	<b>5,48</b>
3/8"	<b>BREX0206</b>	<b>6,07</b>
1/2"	<b>BREX0208</b>	<b>5,55</b>
3/4"	<b>BREX0212</b>	<b>5,87</b>
1"	<b>BREX0216</b>	<b>6,72</b>
1" 1/4	<b>BREX0220</b>	<b>10,37</b>

## Juntas NBR EXPRESS

NBR EXPRESS seals

Joints NBR EXPRESS

Guarnizioni EXPRESS



DN	Part nº Referencia	€
for all sizes	<b>NBEX</b>	<b>0,42</b>

## EXPRESS latón- Tapón

EXPRESS brass- Cap

EXPRESS laiton- Bouchon

EXPRESS ottone - Tappo



DESCRIPTION DESCRIPCIÓN	Part nº Referencia	€
Tapón	<b>BREX04</b>	<b>5,61</b>

## EXPRESS latón- Para manguera

EXPRESS brass- For hose

EXPRESS laiton- Pour tuyau

EXPRESS ottone - Per tubo



Ø OUTER Ø EXT.	SIZE TAMAÑO	Part nº Referencia	€
9	7-9	<b>BREX0508</b>	<b>5,61</b>
10	8-10	<b>BREX0510</b>	<b>4,96</b>
12	11-13	<b>BREX0513</b>	<b>5,22</b>
14	13-16	<b>BREX0514</b>	<b>5,35</b>
17	16-18	<b>BREX0517</b>	<b>8,15</b>
20	19-21	<b>BREX0519</b>	<b>6,52</b>
26	25-27	<b>BREX0525</b>	<b>7,41</b>
31	30-32	<b>BREX0532</b>	<b>8,41</b>

# Acoples GEKA

GEKA Fittings  
Raccords GEKA  
Raccordi GEKA

## GEKA latón -Rosca hembra BSP

GEKA brass- Female thread BSP

GEKA laiton- Filetage femelle BSP

GEKA ottone - Filetto femmina BSP



THREAD ROSCA	Part nº Referencia	€
3/8"	<b>BRGE0106</b>	<b>4,63</b>
1/2"	<b>BRGE0108</b>	<b>4,76</b>
3/4"	<b>BRGE0112</b>	<b>4,76</b>
1"	<b>BRGE0116</b>	<b>4,76</b>
1"1/4	<b>BRGE0120</b>	<b>6,85</b>
1"1/2	<b>BRGE0124</b>	<b>8,09</b>

## GEKA latón -Rosca macho BSP

GEKA brass- Male thread BSP

GEKA laiton- Filetage mâle BSP

GEKA ottone - Filetto maschio BSP



THREAD ROSCA	Part nº Referencia	€
3/8"	<b>BRGE0206</b>	<b>4,63</b>
1/2"	<b>BRGE0208</b>	<b>4,63</b>
3/4"	<b>BRGE0212</b>	<b>4,76</b>
1"	<b>BRGE0216</b>	<b>4,76</b>
1"1/4	<b>BRGE0220</b>	<b>6,33</b>
1"1/2	<b>BRGE0224</b>	<b>7,83</b>

## Juntas NBR GEKA

NBR GEKA seals

Joints NBR GEKA

Guarnizioni NBR GEKA



DN	Part nº Referencia	€
for all sizes	<b>NBRGE</b>	<b>0,42</b>

## GEKA latón -Tapón

GEKA brass- Plug

GEKA laiton- Bouchon

GEKA ottone - Tappo



DESCRIPTION DESCRIPCIÓN	Part nº Referencia	€
Plug	<b>BRGE04</b>	<b>4,63</b>

## GEKA latón -Para manguera

GEKA brass- For hose

GEKA laiton- Pour tuyau

GEKA ottone - Per tubo



DN	Part nº Referencia	€
10	<b>BRGE0510</b>	<b>4,57</b>
13	<b>BRGE0513</b>	<b>4,57</b>
16	<b>BRGE0516</b>	<b>4,89</b>
19	<b>BRGE0519</b>	<b>5,22</b>
25	<b>BRGE0525</b>	<b>6,72</b>
32	<b>BRGE0532</b>	<b>7,96</b>
38	<b>BRGE0538</b>	<b>10,24</b>

# Acoples CAMLOCK MORTERO

MORTAR CAMLOCK Fittings  
Raccords MORTIER CAMLOCK  
Raccordi CAMLOCK MORTAIO

## CAMLOCK MORTERO Tipo A BSP

A Type MORTAR CAMLOCK BSP

CAMLOCK MORTIER Type A BSP

CAMLOCK MORTAIO Tipo A BSP



DN	SERIE	THREAD ROSCA	Part nº Referencia	€
25	22	1"	<b>MT22A2516</b>	<b>18,42</b>
27	22	1"	<b>MT22A2716</b>	<b>18,42</b>
35	22	1" 1/4	<b>MT22A3520</b>	<b>25,11</b>
35	22	1" 1/2	<b>MT22A3524</b>	<b>25,11</b>
50	22	2"	<b>MT22A5032</b>	<b>31,43</b>
35	23.5	1" 1/4	<b>MT23A3520</b>	<b>25,11</b>
35	23.5	1" 1/2	<b>MT23A3524</b>	<b>25,11</b>
50	23.5	2"	<b>MT23A5032</b>	<b>31,43</b>

## CAMLOCK MORTERO Tipo C

C Type MORTAR CAMLOCK

CAMLOCK MORTIER Type C

CAMLOCK MORTAIO Tipo C



DN	SERIE	Part nº Referencia	€
27	22	<b>MT22C2725</b>	<b>41,85</b>
35	22	<b>MT22C3535</b>	<b>49,08</b>
50	22	<b>MT22C5050</b>	<b>66,43</b>
35	23.5	<b>MT23C3535</b>	<b>49,08</b>
50	23.5	<b>MT23C5050</b>	<b>66,43</b>

## CAMLOCK MORTERO Tipo D BSP

D Type MORTAR CAMLOCK BSP

CAMLOCK MORTIER Type D BSP

CAMLOCK MORTAIO Tipo D BSP



DN	SERIE	THREAD ROSCA	Part nº Referencia	€
25	22	1"	<b>MT22D2516</b>	<b>41,85</b>
27	22	1"	<b>MT22D2716</b>	<b>41,85</b>
35	22	1" 1/4	<b>MT22D3520</b>	<b>48,17</b>
35	22	1" 1/2	<b>MT22D3524</b>	<b>48,17</b>
50	22	2"	<b>MT22D5032</b>	<b>65,75</b>
35	23.5	1" 1/4	<b>MT23D3520</b>	<b>48,17</b>
35	23.5	1" 1/2	<b>MT23D3524</b>	<b>48,17</b>
50	23.5	2"	<b>MT23D5032</b>	<b>65,75</b>

## CAMLOCK MORTERO Tipo E

E Type MORTAR CAMLOCK

CAMLOCK MORTIER Type E

CAMLOCK MORTAIO Tipo E



DN	SERIE	Part nº Referencia	€
25	22	<b>MT22E2525</b>	<b>20,93</b>
27	22	<b>MT22E2725</b>	<b>29,53</b>
35	22	<b>MT22E3535</b>	<b>29,75</b>
50	22	<b>MT22E5050</b>	<b>35,61</b>
35	23.5	<b>MT23E3535</b>	<b>20,93</b>
50	23.5	<b>MT23E5050</b>	<b>35,61</b>

# Acoples CHORRO DE ARENA

SANDBLAST Fittings  
Raccords SABLAGE  
Raccordi per SABBIATURA

## CHORRO DE ARENA aluminio acople - para manguera

SANDBLAST aluminum -for hose

SABLAGE aluminium -pour le tuyau

Raccordo SABBIATURA alluminio -per tubo



DN	Part nº Referencia	€
19	<b>ALCH0519</b>	<b>11,42</b>
25	<b>ALCH0525</b>	<b>11,42</b>
32	<b>ALCH0532</b>	<b>16,96</b>
38	<b>ALCH0538</b>	<b>24,20</b>

## CHORRO DE ARENA aluminio para manguera - rosca hembra BSP

SANDBLAST aluminum -for hose-Female thread BSP

SABLAGE aluminium -Filetage femelle BSP pour tuyau

Raccordo SABBIATURA alluminio -per tubo- Filetto femmina BSP



DN	THREAD ROSCA	Part nº Referencia	€
19	1" 1/4	<b>ALCH071219</b>	<b>6,52</b>
25	1" 1/4	<b>ALCH071625</b>	<b>9,78</b>
32	1" 1/4	<b>ALCH072032</b>	<b>13,44</b>
38	1" 1/4	<b>ALCH072438</b>	<b>18,72</b>

## CHORRO DE ARENA aluminio acople - rosca hembra BSP

SANDBLAST aluminum -Female thread BSP

SABLAGE aluminium -Filetage femelle BSP

Raccordo SABBIATURA alluminio -Filetto femmina BSP



THREAD ROSCA	Part nº Referencia	€
1" 1/4	<b>ALCH0120</b>	<b>11,81</b>
1" 1/2	<b>ALCH0124</b>	<b>11,81</b>

## CHORRO DE ARENA latón acople - para manguera

SANDBLAST brass -for hose

SABLAGE laiton -pour le tuyau

Raccordo SABBIATURA ottone -per tubo



DN	Part nº Referencia	€
19	<b>BRCH0519</b>	<b>47,42</b>
25	<b>BRCH0525</b>	<b>51,01</b>
32	<b>BRCH0532</b>	<b>77,62</b>
38	<b>BRCH0538</b>	<b>120,67</b>

## CHORRO DE ARENA latón para manguera - rosca hembra BSP

SANDBLAST brass -for hose-Female thread BSP

SABLAGE laiton -Filetage femelle BSP pour tuyau

Raccordo SABBIATURA ottone -per tubo- Filetto femmina BSP



DN	THREAD ROSCA	Part nº Referencia	€
19	1" 1/4	<b>BRCH071219</b>	<b>39,59</b>
25	1" 1/4	<b>BRCH071625</b>	<b>56,29</b>
32	1" 1/4	<b>BRCH072032</b>	<b>74,43</b>
38	1" 1/4	<b>BRCH072438</b>	<b>100,84</b>

## CHORRO DE ARENA latón acople - rosca hembra BSP

SANDBLAST brass -Female thread BSP

SABLAGE laiton -Filetage femelle BSP

Raccordo SABBIATURA ottone -Filetto femmina BSP



THREAD ROSCA	Part nº Referencia	€
1" 1/4	<b>BRCH0120</b>	<b>52,25</b>
1" 1/2	<b>BRCH0124</b>	<b>52,25</b>

# Acoples CHORRO DE ARENA

SANDBLAST Fittings  
Raccords SABLAGE  
Raccordi per SABBIATURA

## CHORRO DE ARENA nylon acople - para manguera

SANDBLAST nylon for hose

SABLAGE nylon pour le tuyau

Raccordo SABBIATURA nylon per tubo



DN	Part n° Referencia	€
19	<b>NYCH0519</b>	<b>20,17</b>
25	<b>NYCH0525</b>	<b>20,17</b>
32	<b>NYCH0532</b>	<b>20,17</b>
38	<b>NYCH0538</b>	<b>20,17</b>

## CHORRO DE ARENA nylon acople - rosca hembra BSP

SANDBLAST nylon female thread BSP

SABLAGE nylon filetage femelle BSP

Raccordo SABBIATURA nylon filetto femmina BSP



THREAD ROSCA	Part n° Referencia	€
1" 1/4	<b>NYCH0120</b>	<b>18,26</b>
1" 1/2	<b>NYCH0124</b>	<b>18,26</b>

## CHORRO DE ARENA nylon para manguera - rosca hembra BSP

SANDBLAST nylon for hose female thread BSP

SABLAGE nylon filetage femelle BSP pour tuyau

Raccordo SABBIATURA nylon per tubo filetto femmina BSP



DN	THREAD ROSCA	Ø INNER Ø INT.	Part n° Referencia	€
25	1" 1/4 BSP	38.75	<b>NYCH071625</b>	<b>19,98</b>
32	1" 1/4 BSP	50.20	<b>NYCH072032</b>	<b>19,95</b>
38	1" 1/4 BSP	55.60	<b>NYCH072438</b>	<b>19,03</b>

## Juntas NBR CHORRO DE ARENA

SANDBLAST NBR Seals

SABLAGE Joints NBR

SABBIATURA - Guarnizioni NBR



DN	Part n° Referencia	€
for all sizes	<b>NBRCH</b>	<b>0,76</b>

# Acoples BAUER

BAUER Fittings  
Raccords BAUER  
Raccordi BAUER

## BAUER acero kit

BAUER carbon steel kit

BAUER acier kit

BAUER acciaio kit



DN	ØRT	Part n° Referencia	€
2"	50	<b>BE050</b>	<b>51,73</b>
3"	76	<b>BE076</b>	<b>70,85</b>
4"	108	<b>BE108</b>	<b>128,71</b>

Hasta fin de existencias / Until end of stock / Jusqu'à la fin du stock / Fino ad esaurimento scorta

## BAUER acero macho

BAUER carbon steel male

BAUER acier mâle

BAUER acciaio maschio



DN	ØRT	Part n° Referencia	€
2"	50	<b>BEM050</b>	<b>39,95</b>
3"	76	<b>BEM076</b>	<b>56,15</b>
4"	108	<b>BEM108</b>	<b>96,04</b>

## BAUER acero hembra

BAUER carbon steel female

BAUER acier femelle

BAUER acciaio femmina



DN	ØRT	Part n° Referencia	€
2"	50	<b>BEF050</b>	<b>11,78</b>
3"	76	<b>BEF076</b>	<b>14,70</b>
4"	108	<b>BEF108</b>	<b>32,67</b>

## Juntas NBR BAUER

NBR BAUER seals

Joints NBR BAUER

Guarnizioni NBR BAUER



DN	Part n° Referencia	€
2"	<b>NBRBE050</b>	<b>2,72</b>
3"	<b>NBRBE076</b>	<b>5,65</b>
4"	<b>NBRBE108</b>	<b>9,80</b>

# Acoples PERROT

PERROT Fittings  
Raccords PERROT  
Raccordi PERROT

Industrial hoses

Industrial fittings

Stainless steel hose, welding fittings and flanges

Low pressure

Air conditioning hoses and fittings

## PERROT acero kit

PERROT carbon steel kit

PERROT acier kit

PERROT acciaio kit



DN	Ø OUTER Ø EXT.	Part n° Referencia	€
2"	52.3	<b>PE050</b>	<b>70,45</b>
3"	77.4	<b>PE089</b>	<b>112,32</b>
4"	102.4	<b>PE108</b>	<b>193,73</b>

Hasta fin de existencias / Until end of stock / Jusqu'à la fin du stock / Fino ad esaurimento scorta

## PERROT acero macho

PERROT carbon steel male

PERROT acier mâle

PERROT acciaio maschio



DN	Ø OUTER Ø EXT.	Part n° Referencia	€
2"	52.3	<b>PEM050</b>	<b>18,92</b>
3"	77.4	<b>PEM089</b>	<b>31,37</b>
4"	102.4	<b>PEM108</b>	<b>67,18</b>

## PERROT acero hembra

PERROT carbon steel female

PERROT acier femelle

PERROT acciaio femmina



DN	Ø OUTER Ø EXT.	Part n° Referencia	€
2"	52.3	<b>PEF050</b>	<b>51,53</b>
3"	77.4	<b>PEF089</b>	<b>80,95</b>
4"	102.4	<b>PEF108</b>	<b>126,54</b>

## Juntas NBR PERROT

NBR PERROT seals

Joints NBR PERROT

Guarnizioni NBR PERROT



DN	Part n° Referencia	€
2"	<b>NBRPE050</b>	<b>3,65</b>
3"	<b>NBRPE089</b>	<b>3,65</b>
4"	<b>NBRPE108</b>	<b>6,52</b>

## Acoples vapor tipo BOSS

Steam fittings BOSS type  
Raccords vapeur type BOSS  
Raccordi per vapore tipo BOSS

### BOSS acero kit BSP

BOSS carbon steel kit BSP

BOSS acier kit BSP

BOSS acciaio kit BSP



DN	THREAD ROSCA	Part n° Referencia	€
1/2"	1/2" BSP	<b>BO0813</b>	<b>26,35</b>
3/4"	3/4" BSP	<b>BO1219</b>	<b>32,81</b>
1"	1" BSP	<b>BO1625</b>	<b>33,46</b>
1"1/4	1" 1/4 BSP	<b>BO2032</b>	<b>59,29</b>
1"1/2	1" 1/2 BSP	<b>BO2438</b>	<b>60,92</b>
2"	2" BSP	<b>BO3251</b>	<b>81,86</b>



**CONEXIÓN STD**  
+  
**CASQUILLO STD**  
+  
**MANGUERA**  
**INDUS TrAle®**

**STD FITTINGS**  
+  
**STD FERRULES**  
+  
**HOSES**  
**INDUS TrAle®**



# Acoples vapor EN 14423

Steam EN 14423 fittings  
Raccords vappeur EN 14423  
Raccordi per vapore EN 14423

## Abrazadera EN 14423 acero

EN 14423 clamp steel

Collier EN 14423 acier

Collare EN 14423 acciaio



DN	Ø INNER Ø INT.	Part n° Referencia	€
13X6	24-26	<b>AB06024026</b>	<b>17,87</b>
19X7	32-34	<b>AB06032034</b>	<b>23,80</b>
25X7.5	39-41	<b>AB06039041</b>	<b>38,85</b>
32X8	47-50	<b>AB06047050</b>	<b>48,84</b>
38X8	53-56	<b>AB06053056</b>	<b>65,30</b>
50X9	67-69	<b>AB06067069</b>	<b>76,93</b>

## Macho Espiga EN 14423 acero

Male-hose tail EN 14423 steel

Mâle à douille EN 14423 acier

Maschio con inserto EN 14423 acciaio



DN	THREAD ROSCA	Part n° Referencia	€
13	1/2" BSPT	<b>STE0108</b>	<b>6,16</b>
19	3/4" BSPT	<b>STE0112</b>	<b>8,74</b>
25	1" BSPT	<b>STE0116</b>	<b>13,19</b>
32	1" 1/4 BSPT	<b>STE0120</b>	<b>22,86</b>
38	1" 1/2 BSPT	<b>STE0124</b>	<b>28,71</b>
50	2" BSPT	<b>STE0132</b>	<b>46,50</b>

## Hembra Espiga EN 14423 acero

Female-hose tail EN 14423 steel

Femelle à douille EN 14423 acier

Femmina con inserto EN 14423 acciaio



DN	THREAD ROSCA	Part n° Referencia	€
13	1/2" BSP	<b>STE0208</b>	<b>9,67</b>
19	3/4" BSP	<b>STE0212</b>	<b>13,81</b>
25	1" BSP	<b>STE0216</b>	<b>20,91</b>
32	1" 1/4 BSP	<b>STE0220</b>	<b>30,12</b>
38	1" 1/2 BSP	<b>STE0224</b>	<b>40,02</b>
50	2" BSP	<b>STE0232</b>	<b>61,56</b>

# Accesorios industriales

Industrial accessories  
Accessoires industriels  
Accessori industriale

## Campana aluminio para racor industrial - cierre 45°

*Crimping Ferrule 45° closure (aluminium)*

*Jupe aluminium pour raccord industriel -fermeture 45°*

*Boccola in alluminio per raccordo industriale - chiusura 45°*



Ø INNER Ø INT.	Part n° Referencia	€
11	ALCA011000	0,26
12.9	ALCA012900	0,26
13.4	ALCA013400	0,27
14.5	ALCA014500	0,29
15.5	ALCA015500	0,33
17.5	ALCA017500	0,35
18.5	ALCA018500	0,38
20.5	ALCA020500	0,44
21.5	ALCA021500	0,49
24.5	ALCA024500	0,58
26.5	ALCA026500	0,71
28.5	ALCA028500	0,87
30	ALCA030000	1,06
33	ALCA033000	1,28
36	ALCA036000	1,45
39	ALCA039000	1,83
46	ALCA046000	2,13
43	ALCA043000	2,16
48	ALCA048000	2,56
50	ALCA050000	4,50
54	ALCA054000	4,45
56.5	ALCA056500	7,18
63	ALCA063000	5,00
67	ALCA067000	11,02
84	ALCA083000	13,63
98	ALCA099000	14,34
123	ALCA121000	18,72

## Abrazadera EN 14420-3 aluminio

*Clamp EN 14420-3 aluminium*

*Collier EN 14420-3 aluminium*

*Collare EN 14420-3 aluminio*



Ø HOSE Ø MANGUERA	Ø INNER Ø INT.	Part n° Referencia	€
13x5	21-25 mm	ALAB01021025	10,50
19X6	29-33 mm	ALAB01029033	10,65
25x5	34-37 mm	ALAB01034037	11,57
25x6	36-39 mm	ALAB01036039	11,57
32X5	41-44 mm	ALAB01041044	13,09
32x6	42-46 mm	ALAB01042046	13,09
38X5	47-51 mm	ALAB01047051	13,93
38X6.5	49-53 mm	ALAB01049053	13,93
38x8	52-56 mm	ALAB01052056	13,93
38x10	56-60 mm	ALAB01056060	13,93
50X5.5	62-64 mm	ALAB01060064	21,08
50x8	63-67 mm	ALAB01063067	21,08
50X10	68-72 mm	ALAB01068072	22,45
63x6	74-77 mm	ALAB01074077	28,08
63X8	77-81 mm	ALAB01077081	30,90
65x10	84-87 mm	ALAB01084087	39,57
75x6	87-90 mm	ALAB01087090	33,71
75x8	89-94 mm	ALAB01089094	36,53
75X10	94-98 mm	ALAB01094098	37,21
100x8	114-119 mm	ALAB01114119	70,24

## Abrazadera EXPRESS acero

*Clamp EXPRESS steel*

*Collier EXPRESS acier*

*Collare EXPRESS acciaio*



Ø INNER Ø INT.	Part n° Referencia	€
19-21 mm	AB031921	1,24
22-24 mm	AB032224	1,30
25-27 mm	AB032527	1,37
28-30 mm	AB032830	1,63
31-33 mm	AB033133	2,02
34-36 mm	AB033436	3,46
37-39 mm	AB033739	4,37

# Accesorios industriales

Industrial accessories  
Accessoires industriels  
Accessori industriale

## Abrazadera tipo BOSS acero

Clamp BOSS type steel

Collier type BOSS acier

Collare tipo BOSS acciaio



Ø INNER Ø INT.	Nº BOLTS Nº TORNILLOS	Part nº Referencia	€
24-27 mm	2	<b>AB05024027</b>	<b>4,17</b>
30-33 mm	2	<b>AB05030033</b>	<b>7,83</b>
38-43 mm	2	<b>AB05038043</b>	<b>15,98</b>
38-43 mm	4	<b>AB05438043</b>	<b>19,90</b>
43-49 mm	4	<b>AB05043049</b>	<b>17,48</b>
54-60 mm	4	<b>AB05054060</b>	<b>23,22</b>
63-71 mm	4	<b>AB05063071</b>	<b>28,77</b>

## Abrazadera DIN 20039 A acero

Clamp DIN 20039 A steel

Collier DIN 20039 A acier

Collare DIN 20039 A acciaio



Ø INNER Ø INT.	Part nº Referencia	€
22-29 mm	<b>AB04022029</b>	<b>5,22</b>
28-34 mm	<b>AB04028034</b>	<b>5,48</b>
32-40 mm	<b>AB04032040</b>	<b>6,00</b>

## Abrazadera alta presión W1 acero

Clamp high pressure W1 steel

Collier haute pression W1 acier

Collare alta pressione W1 acciaio



Ø INNER Ø INT.	Part nº Referencia	€
17-19mm	<b>AB02017019</b>	<b>1,36</b>
20-22mm	<b>AB02020022</b>	<b>1,37</b>
23-25mm	<b>AB02023025</b>	<b>1,38</b>
26-28mm	<b>AB02026028</b>	<b>1,40</b>
29-31mm	<b>AB02029031</b>	<b>1,49</b>
32-35mm	<b>AB02032035</b>	<b>1,52</b>
36-39mm	<b>AB02036039</b>	<b>1,54</b>
40-43mm	<b>AB02040043</b>	<b>1,57</b>
44-47mm	<b>AB02044047</b>	<b>1,88</b>
48-51mm	<b>AB02048051</b>	<b>1,91</b>
52-55mm	<b>AB02052055</b>	<b>1,94</b>
56-59mm	<b>AB02056059</b>	<b>1,98</b>
60-63mm	<b>AB02060063</b>	<b>2,02</b>
64-67mm	<b>AB02064067</b>	<b>2,09</b>
68-73mm	<b>AB02068073</b>	<b>2,75</b>
74-79mm	<b>AB02074079</b>	<b>2,83</b>
80-85mm	<b>AB02080085</b>	<b>2,92</b>
86-91mm	<b>AB02086091</b>	<b>3,02</b>
92-97mm	<b>AB02092097</b>	<b>3,08</b>
98-103mm	<b>AB02098103</b>	<b>3,16</b>
104-112mm	<b>AB02104112</b>	<b>3,25</b>
113-121mm	<b>AB02113121</b>	<b>3,32</b>
122-130mm	<b>AB02122130</b>	<b>3,37</b>
131-139mm	<b>AB02131139</b>	<b>4,77</b>
140-148mm	<b>AB02140148</b>	<b>5,03</b>
149-161mm	<b>AB02149161</b>	<b>5,22</b>
162-174mm	<b>AB02162174</b>	<b>5,52</b>
175-187mm	<b>AB02175187</b>	<b>5,67</b>
188-200mm	<b>AB02188200</b>	<b>5,97</b>

## Inox Corrugado

*Stainless steel hose, welding fittings and flanges*

*Tuyau Inox, raccords et brides à souder*

*Tubi Inox, raccordi e flange a saldare*

### **Manguera Inox**

*Stainless steel hose*

*Tuyau Inox*

*Tubi inox*

167

### **Racores soldables**

*Welding fittings*

*Raccords à souder*

*Raccordi a saldare*

169

### **Bridas soldables**

*Welding flanges*

*Brides à souder*

*Flange a saldare*

175

3

# Manguera Inox

*Stainless steel hose*

Tuyau Inox

Tubi inox

■ Mangueras Inox Corrugado y Malla Inox / Convuluted stainless steel hoses and AISI 304 Braid / Tuyaux inox onduleux et Tresse Inox / Tubi Inox corrugato e Maglia Inox | 167



M93211



M93161304



M93161



M93161304.EF



M93162304



M93212



M304



M3160

# Racores soldables

Welding fittings  
Raccords à souder  
Raccordi a saldare

## ■ Racores soldables BSP / BSP Welding fittings / Raccords à souder BSP / Raccordi a saldare BSP

169

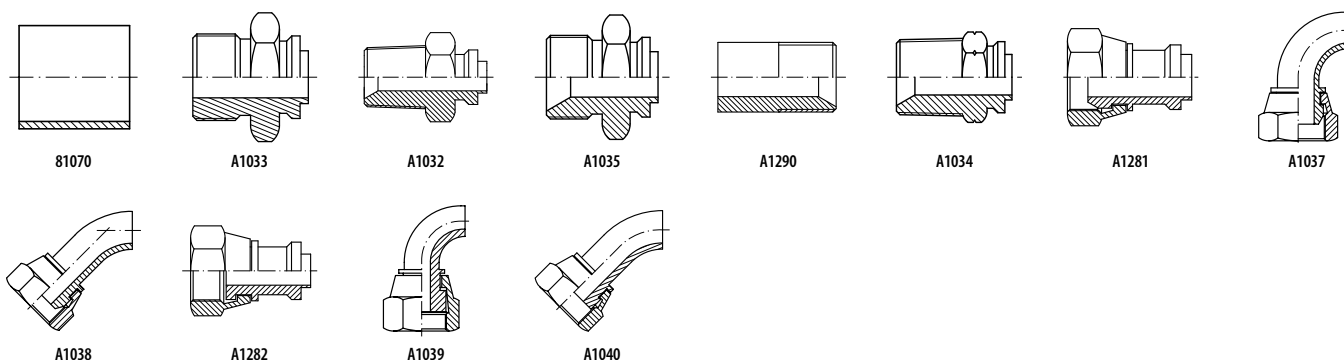

## ■ Racores soldables JIC 37° / JIC 37° Welding fittings / Raccords à souder JIC 37° / Raccordi a saldare JIC 37°

171

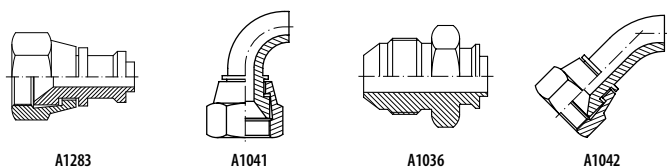

## ■ Racores soldables métricos / Metric Welding fittings / Raccords à souder métriques / Raccordi a saldare metrici

172

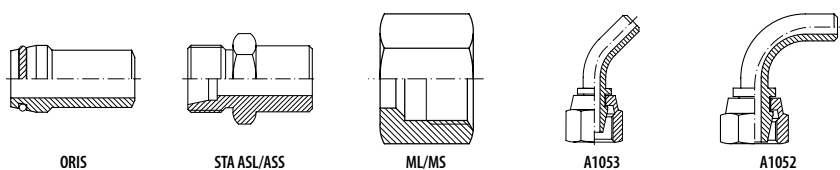

## ■ Cono y tuerca / Nipple and nut / Collet et écrou / Ogiva e dado

174

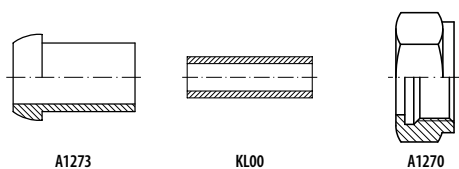

## ■ Racores para soldar >2" / Welding fittings >2" / Raccords à souder >2" / Raccordi a saldare >2"

174

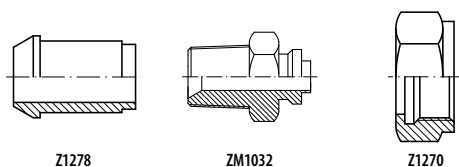

## Bridas soldables

Welding flanges  
Brides à souder  
Flange a saldare

- Bridas fijas para soldar / Fixed Forged flanges / Brides DIN à souder fixes / Flangia a saldare | 175

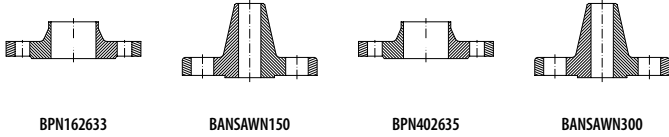

BPN162633

BANSAWN150

BPN402635

BANSAWN300

- Conjunto brida DIN 2642 / DIN 2642 swivel flanges set / Ensemble brides tournantes DIN 2642 / Flangia girevole DIN 2642 | 176

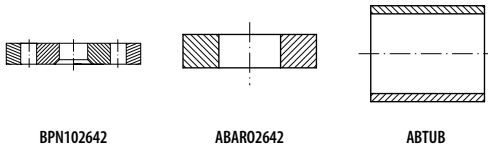

BPN102642

ABARO2642

ABTUB

- Conjunto brida DIN 2656 / DIN 2656 swivel flanges set / Ensemble brides tournantes DIN 2656 / Flangia girevole DIN 2656 | 177

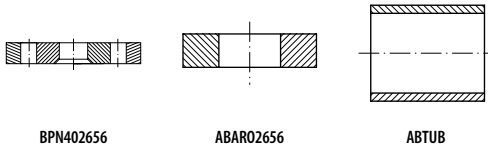

BPN402656

ABARO2656

ABTUB

- Conjunto brida ANSI-ASA / ANSI-ASA swivel flanges set / Ensemble brides ANSI-ASA / Flangia girevole ANSI-ASA | 178

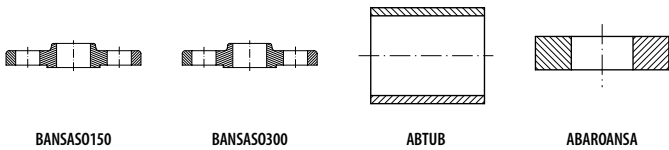

BANSAS0150

BANSAS0300

ABTUB

ABAROANSA

# Manguera Inox

Stainless steel hose

Tuyau Inox

Tubi inox

Industrial hoses

Industrial fittings

Stainless steel hose, welding fittings and flanges

Low pressure

Air conditioning hoses and fittings

## Inox corrugado AISI 321 con una malla AISI 304

Convuluted S.S. AISI 321 hose with one braid S.S. AISI 304

Inox onduleux AISI 321 avec une tresse inox AISI 304

Tubo in Inox corrugato 321 con una maglia AISI 304



DN	Ø INNER Ø INT.	Part nº Referencia	€
1/4"	6.2	M93211006	7,43
3/8"	10.3	M93211010	9,36
1/2"	12.2	M93211012	9,77
5/8"	16.2	M93211016	15,74
3/4"	20.2	M93211020	20,34
1"	25.4	M93211025	25,43
1" 1/4	34.3	M93211032	31,00
1" 1/2	40.1	M93211040	41,29
2"	50.3	M93211050	56,91
2" 1/2	65.6	M93211065	79,51
3"	80.3	M93211080	87,58
4"	100.8	M93211100	115,83

## Inox corrugado AISI 316 con una malla AISI 304

Convuluted S.S. AISI 316 hose with one braid S.S. AISI 304

Inox onduleux AISI 316 avec une tresse inox AISI 304

Tubo in Inox corrugato 316 con una maglia AISI 304



DN	Ø INNER Ø INT.	Part nº Referencia	€
1/4"	6.2	M93161304006	7,43
3/8"	10.3	M93161304010	10,25
1/2"	12.2	M93161304012	10,90
3/4"	20.2	M93161304020	22,04
1"	25.4	M93161304025	28,33
1" 1/4	34.3	M93161304032	35,44
1" 1/2	40.1	M93161304040	48,03
2"	50.3	M93161304050	64,57
2" 1/2	65.6	M93161304065	90,81
3"	80.3	M93161304080	98,07
4"	100.8	M93161304100	133,59

## Inox corrugado AISI 316 con una malla AISI 316

Convuluted S.S. AISI 316 hose with one braid S.S. AISI 316

Inox onduleux AISI 316 avec une tresse inox AISI 316

Tubo in Inox corrugato 316 con una maglia AISI 316



DN	Ø INNER Ø INT.	Part nº Referencia	€
1/4"	6.2	M93161006	8,07
3/8"	10.3	M93161010	11,70
1/2"	12.2	M93161012	12,92
3/4"	20.2	M93161020	27,04
1"	25.4	M93161025	35,11
1" 1/4	34.3	M93161032	45,20
1" 1/2	40.1	M93161040	64,57
2"	50.3	M93161050	86,37
2" 1/2	65.6	M93161065	104,93
3"	80.3	M93161080	113,01
4"	100.8	M93161100	157,40

## Inox corrugado AISI 316 con una malla AISI 304 extra flexible

Convuluted S.S. AISI 316 hose with one braid S.S. AISI 304 extra flexible

Inox onduleux AISI 316 avec une tresse inox AISI 304 extra flexible

Tubo inox corrugato AISI 316 con una treccia inox AISI 304 extra flessibile



DN	Ø INNER Ø INT.	Part nº Referencia	€
3/4"	20	M93161304020EF	27,44
1"	25	M93161304025EF	34,71
1" 1/4	34.3	M93161304032EF	46,41
1" 1/2	39.8	M93161304040EF	63,77
2"	50	M93161304050EF	85,56

## Inox corrugado AISI 316 con dos mallas AISI 304

Convuluted S.S. AISI 316 hose with two braids S.S. AISI 304

Inox onduleux AISI 316 avec deux tresses inox AISI 304

Tubo in Inox corrugato 316 con due maglie AISI 304



DN	Ø INNER Ø INT.	Part nº Referencia	€
1/4"	6.2	M93162304006	8,48
3/8"	10.3	M93162304010	12,27
1/2"	12.2	M93162304012	13,56
3/4"	20.2	M93162304020	28,33
1"	25.4	M93162304025	36,40
1" 1/4	34.3	M93162304032	47,46
1" 1/2	40.1	M93162304040	67,80
2"	50.3	M93162304050	90,69
2" 1/2	65.6	M93162304065	110,18
3"	80.3	M93162304080	118,66
4"	100.8	M93162304100	165,27

# Manguera Inox

Stainless steel hose

Tuyau Inox

Tubi inox

## Malla inox 304

AISI 304 braid

Tresse inox 304



Maglia di acciaio Inox 304

Ø INNER Ø INT.	Part nº Referencia	€
9,6	<b>M304009.6</b>	<b>3,07</b>
12,3	<b>M304012.3</b>	<b>3,39</b>
14,3	<b>M304014.3</b>	<b>4,44</b>
16,7	<b>M304016.7</b>	<b>4,84</b>
21,6	<b>M304021.6</b>	<b>8,56</b>
26,8	<b>M304026.8</b>	<b>10,33</b>
32,2	<b>M304032.2</b>	<b>11,87</b>
41,1	<b>M304041.1</b>	<b>16,95</b>
49,8	<b>M304049.8</b>	<b>18,97</b>
60,3	<b>M304060.3</b>	<b>29,06</b>
80,8	<b>M304080.8</b>	<b>41,17</b>

## Malla inox 316

AISI 316 braid

Tresse inox 316



Maglia di acciaio Inox 316

Ø INNER Ø INT.	Part nº Referencia	€
9,6	<b>M316009.6</b>	<b>4,04</b>
12,3	<b>M316012.3</b>	<b>4,44</b>
14,3	<b>M316014.3</b>	<b>5,65</b>
16,7	<b>M316016.7</b>	<b>6,46</b>
21,6	<b>M316021.6</b>	<b>11,30</b>
26,8	<b>M316026.8</b>	<b>13,56</b>
32,2	<b>M316032.2</b>	<b>15,74</b>
41,1	<b>M316041.1</b>	<b>22,44</b>
49,8	<b>M316049.8</b>	<b>27,85</b>
60,3	<b>M316060.3</b>	<b>37,94</b>
80,8	<b>M316080.8</b>	<b>50,45</b>

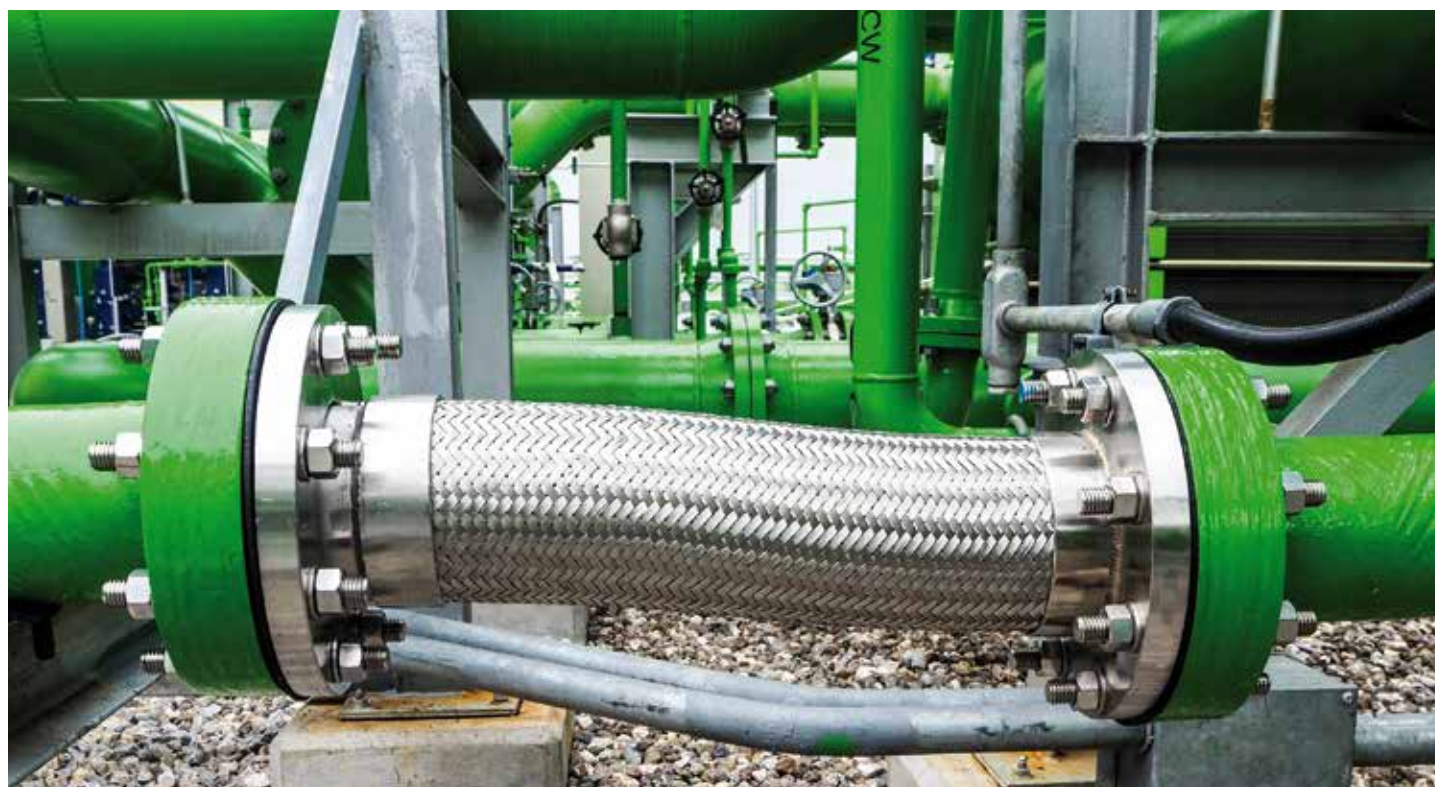

**Amplia variedad de manguera inoxidable corrugado para instalaciones en el sector químico, centrales eléctricas y plantas petroquímicas.**

**Wide range of convoluted stainless steel hoses for a variety of facilities, such as chemical sector, power plant, oil and gas.**

# Racores soldables

Welding fittings  
Raccords à souder  
Raccordi a saldare

## Casquillo soldable Inox corrugado

Convuluted SS welding ferrule

Jupe à souder Inox convoluté

Boccola a saldare per inox corrugato

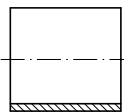

DN	Ø INNER Ø INT.	Part nº Referencia	€
1/4"	14	<b>810700400</b>	*
1/4"	12	<b>810700401</b>	*
3/8"	19	<b>810700600</b>	*
3/8"	17	<b>810700601</b>	*
1/2"	22	<b>810700800</b>	*
1/2"	19	<b>810700801</b>	*
5/8"	25	<b>810701000</b>	*
3/4"	30	<b>810701200</b>	*
3/4"	32	<b>810701201</b>	*
1"	35	<b>810701500</b>	*
1"	38	<b>810701600</b>	*
1"1/4"	47,8	<b>810702000</b>	*
1"1/4"	44,3	<b>810702001</b>	*
1"1/2"	56,3	<b>810702400</b>	*
2"	66	<b>810703201</b>	*
2"1/2"	84,9	<b>810704000</b>	*
2"1/2"	95,6	<b>810704001</b>	*
3"	100	<b>810704801</b>	*
4"	125	<b>810706400</b>	*

\*Ver precio en catálogo de inox 173 / \*Prices in Stainless Steel Catalogue p.173 / \*Prix dans le Catalogue Acier Inox p.173 / \*Prezzi in Acciaio Inossidabile p.173

## Macho fijo BSP asiento plano - soldable con guía

Welding fixed male BSP flat seat with guide

Mâle fixe BSP fond plat à souder avec guide

Maschio BSP faccia piana, a saldare con guida

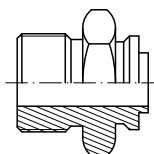

DN	THREAD ROSCA	Part nº Referencia	€
1/4"	1/4" BSP	<b>A103304</b>	<b>1,84</b>
3/8"	3/8" BSP	<b>A103306</b>	<b>2,24</b>
1/2"	1/2" BSP	<b>A103308</b>	<b>2,93</b>
3/4"	3/4" BSP	<b>A103312</b>	<b>4,25</b>
1"	1" BSP	<b>A103316</b>	<b>6,93</b>
1"1/4"	1"1/4 BSP	<b>A103320</b>	<b>13,98</b>
1"1/2"	1"1/2 BSP	<b>A103324</b>	<b>18,19</b>
2"	2" BSP	<b>A103332</b>	<b>28,27</b>

## Macho cónico BSPT con guía

Welding adaptor BSPT with guide

Mamelon hexagonal BSPT conique à souder (bw) + guide

Maschio conico BSPT con guida

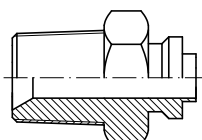

DN	THREAD ROSCA	Part nº Referencia	€
1/4"	1/4" BSPT	<b>A103204</b>	<b>2,18</b>
3/8"	3/8" BSPT	<b>A103206</b>	<b>2,46</b>
1/2"	1/2" BSPT	<b>A103208</b>	<b>3,51</b>
3/4"	3/4" BSPT	<b>A103212</b>	<b>3,74</b>
1"	1" BSPT	<b>A103216</b>	<b>6,58</b>
1"1/4"	1"1/4 BSPT	<b>A103220</b>	<b>15,60</b>
1"1/2"	1"1/2 BSPT	<b>A103224</b>	<b>16,97</b>
2"	2" BSPT	<b>A103232</b>	<b>21,46</b>
2"1/2"	2"1/2 BSPT	<b>A103240</b>	<b>64,67</b>

## Macho BSP cono 60° con guía

Welding adaptor BSP 60° with guide

Mamelon hexagonal BSP à souder (bw) + guide

Maschio BSP a saldare sede 60° con guida

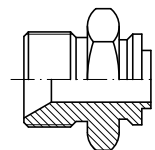

DN	THREAD ROSCA	Part nº Referencia	€
1/4"	1/4" BSP	<b>A103504</b>	<b>1,24</b>
3/8"	3/8" BSP	<b>A103506</b>	<b>1,73</b>
1/2"	1/2" BSP	<b>A103508</b>	<b>2,13</b>
3/4"	3/4" BSP	<b>A103512</b>	<b>3,36</b>
1"	1" BSP	<b>A103516</b>	<b>4,86</b>
1"1/4"	1"1/4 BSP	<b>A103520</b>	<b>11,44</b>
1"1/2"	1"1/2 BSP	<b>A103524</b>	<b>16,12</b>
2"	2" BSP	<b>A103532</b>	<b>30,34</b>

## Empalme liso soldable rosca BSP (60°)

Welding union BSP male (60°)

Embout mâle lisse à souder gaz cyl BSP (60°)

Mezzo nipples tondo a saldare BSP 60°

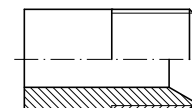

THREAD ROSCA	Part nº Referencia	€
1/8" BSP	<b>A129002</b>	<b>1,36</b>
1/4" BSP	<b>A129004</b>	<b>0,79</b>
3/8" BSP	<b>A129006</b>	<b>1,00</b>
1/2" BSP	<b>A129008</b>	<b>1,22</b>
3/4" BSP	<b>A129012</b>	<b>2,22</b>
1" BSP	<b>A129016</b>	<b>5,16</b>
1"1/4 BSP	<b>A129020</b>	<b>15,41</b>
1"1/2 BSP	<b>A129024</b>	<b>16,87</b>
2" BSP	<b>A129032</b>	<b>16,71</b>

## Macho fijo NPT - soldable con guía

Welding fixed male NPT flat seat with guide

Mâle fixe NPT à souder avec guide

Maschio NPT, a saldare con guida

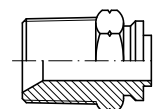

DN	THREAD ROSCA	Part nº Referencia	€
1/4"	1/4" NPT	<b>A103404</b>	<b>1,52</b>
3/8"	3/8" NPT	<b>A103406</b>	<b>2,22</b>
1/2"	1/2" NPT	<b>A103408</b>	<b>2,51</b>
3/4"	3/4" NPT	<b>A103412</b>	<b>4,39</b>
1"	1" NPT	<b>A103416</b>	<b>6,71</b>
1" 1/4	1" 1/4 NPT	<b>A103420</b>	<b>13,05</b>
1" 1/2	1" 1/2 NPT	<b>A103424</b>	<b>16,12</b>
2"	2" NPT	<b>A103432</b>	<b>31,88</b>

# Racores soldables

Welding fittings  
Raccords à souder  
Raccordi a saldare

## Hembras giratorias prensada BSP 60° - soldable con guía

Welding BSP swivel female 60° with guide

Femelle tournante BSP 60° à souder avec guide

Femmina diritta girevole BSP, a saldare con guida

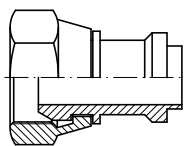

DN	THREAD ROSCA	Part n° Referencia	€
1/4"	1/4" BSP	A128104	1,60
3/8"	3/8" BSP	A128106	2,00
1/2"	1/2" BSP	A128108	2,85
3/4"	3/4" BSP	A128112	4,42
1"	1" BSP	A128116	6,93
1" 1/4	1" 1/4 BSP	A128120	11,79
1" 1/2	1" 1/2 BSP	A128124	15,46

## Hembras giratorias prensada 90° BSP 60° - soldable

Welding 90° BSP swivel female 60°

Femelle tournante 90° à souder

Femmina 90° girevole BSP, a saldare

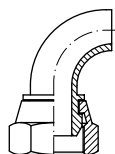

DN	THREAD ROSCA	Part n° Referencia	€
1/4"	1/4" BSP	A103704	2,52
3/8"	3/8" BSP	A103706	3,20
1/2"	1/2" BSP	A103708	5,30
3/4"	3/4" BSP	A103712	7,83
1"	1" BSP	A103716	12,68
1" 1/4	1" 1/4 BSP	A103720	19,23
1" 1/2	1" 1/2 BSP	A103724	27,68
2"	2" BSP	A103732	49,89

## Hembras giratorias prensada 45° BSP 60° - soldable

Welding 45° BSP swivel female 60°

Femelle tournante 45° à souder

Femmina 45° girevole BSP, a saldare

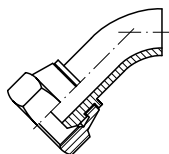

DN	THREAD ROSCA	Part n° Referencia	€
1/4"	1/4" BSP	A103804	2,56
3/8"	3/8" BSP	A103806	3,36
1/2"	1/2" BSP	A103808	4,80
3/4"	3/4" BSP	A103812	9,19
1"	1" BSP	A103816	11,62
1" 1/4	1" 1/4 BSP	A103820	18,68
1" 1/2	1" 1/2 BSP	A103824	27,68
2"	2" BSP	A103832	47,05

## Hembras giratorias prensada BSP asiento plano - soldable con guía

Welding BSP swivel female flat seat

Femelle tournante BSP à souder fond plat

Femm. gir. BSP faccia piana, a saldare con guida

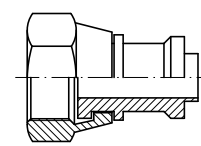

DN	THREAD ROSCA	Part n° Referencia	€
1/4"	1/4" BSP	A128204	1,79
3/8"	3/8" BSP	A128206	2,24
1/2"	1/2" BSP	A128208	3,85
3/4"	3/4" BSP	A128212	5,55
1"	1" BSP	A128216	9,31
1" 1/4	1" 1/4 BSP	A128220	16,82
1" 1/2	1" 1/2 BSP	A128224	24,60
2"	2" BSP	A128232	41,34

## Hembras giratorias prensada 90° BSP asiento plano - soldable

Welding 90° BSP swivel female 60° flat seat

Femelle tournante 90° à souder fond plat

Femm. 90° gir. BSP faccia piana, a saldare



DN	THREAD ROSCA	Part n° Referencia	€
1/4"	1/4" BSP	A103904	2,95
3/8"	3/8" BSP	A103906	3,76
1/2"	1/2" BSP	A103908	5,37
3/4"	3/4" BSP	A103912	10,29
1"	1" BSP	A103916	11,62
1" 1/4	1" 1/4 BSP	A103920	20,92
1" 1/2	1" 1/2 BSP	A103924	30,99
2"	2" BSP	A103932	52,67

## Hembras giratorias prensada 45° BSP asiento plano - soldable

Welding 45° BSP swivel female 60° flat seat

Femelle tournante 45° à souder fond plat

Femm. 45° gir. BSP faccia piana, a saldare

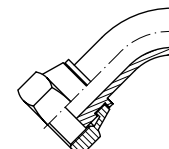

DN	THREAD ROSCA	Part n° Referencia	€
1/4"	1/4" BSP	A104004	3,13
3/8"	3/8" BSP	A104006	4,28
1/2"	1/2" BSP	A104008	5,82
3/4"	3/4" BSP	A104012	10,29
1"	1" BSP	A104016	11,62
1" 1/4	1" 1/4 BSP	A104020	20,92
1" 1/2	1" 1/2 BSP	A104024	30,99
2"	2" BSP	A104032	52,67

# Racores soldables

Welding fittings  
Raccords à souder  
Raccordi a saldare

## Hembra giratoria prensada JIC 37° - soldable con guía

Welding crimped JIC 37° swivel female with guide

Embout à sertir femelle tournante JIC37° à souder

Femmina girevole JIC 37°, a saldare

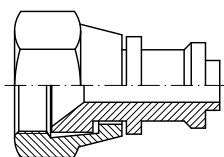

DN	THREAD ROSCA	Part nº Referencia	€
1/4"	7/16" 20h UNF	<b>A12830704</b>	<b>1,49</b>
1/4"	1/2" 20h UNF	<b>A12830804</b>	<b>1,92</b>
3/8"	9/16" 18h UNF	<b>A12830906</b>	<b>2,08</b>
3/8"	3/4" 16h UNF	<b>A12831206</b>	<b>3,04</b>
1/2"	3/4" 16h UNF	<b>A12831208</b>	<b>3,04</b>
1/2"	7/8" 14h UNF	<b>A12831408</b>	<b>3,28</b>
3/4"	1" 1/16 12h UNF	<b>A12831712</b>	<b>4,96</b>
1"	1" 5/16 12h UNF	<b>A12832116</b>	<b>8,79</b>
1" 1/4	1" 5/8 12h UNF	<b>A12832620</b>	<b>14,54</b>
1" 1/2	1" 7/8 12h UNF	<b>A12833024</b>	<b>21,98</b>

## Hembra giratoria 90° prensada JIC 37° - soldable

Welding 90° JIC 37° swivel female

Femelle tournante 90° JIC 37° à souder

Femmina 90° girevole JIC 37°, a saldare

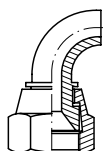

DN	THREAD ROSCA	Part nº Referencia	€
1/4"	7/16" 20h UNF	<b>A10410704</b>	<b>2,68</b>
1/4"	1/2" 20h UNF	<b>A10410804</b>	<b>3,13</b>
3/8"	9/16" 18h UNF	<b>A10410906</b>	<b>3,76</b>
1/2"	3/4" 16h UNF	<b>A10411208</b>	<b>5,37</b>
1/2"	7/8" 14h UNF	<b>A10411408</b>	<b>6,11</b>
3/4"	1" 1/16 12h UNF	<b>A10411712</b>	<b>8,39</b>
1"	1" 5/16 12h UNF	<b>A10412116</b>	<b>13,99</b>
1" 1/4	1" 5/8 12h UNF	<b>A10412620</b>	<b>27,20</b>
1" 1/2	1" 7/8 12h UNF	<b>A10413024</b>	<b>38,92</b>

## Macho JIC 37° - soldable con guía

Welding JIC 37° male with guide

Mâle JIC 37° à souder avec guide

Maschio JIC 37° a saldare con guida

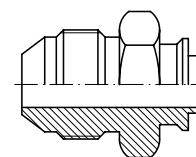

DN	THREAD ROSCA	Part nº Referencia	€
1/4"	7/16" 20h UNF	<b>A10360704</b>	<b>1,49</b>
1/4"	1/2" 20h UNF	<b>A10360804</b>	<b>2,05</b>
3/8"	9/16" 18h UNF	<b>A10360906</b>	<b>1,75</b>
3/8"	3/4" 16h UNF	<b>A10361206</b>	<b>2,78</b>
1/2"	3/4" 16h UNF	<b>A10361208</b>	<b>2,65</b>
1/2"	7/8" 14h UNF	<b>A10361408</b>	<b>3,04</b>
5/8"	7/8" 14h UNF	<b>A10361410</b>	<b>3,41</b>
3/4"	1" 1/16 12h UNF	<b>A10361712</b>	<b>4,95</b>
1"	1" 5/16 12h UNF	<b>A10362116</b>	<b>10,23</b>
1" 1/4	1" 5/8 12h UNF	<b>A10362620</b>	<b>17,72</b>
1" 1/4	1" 7/8 12h UNF	<b>A10363020</b>	<b>22,99</b>

## Hembra giratoria 45° prensada JIC 37° - soldable

Welding 45° JIC 37° swivel female

Femelle tournante 45° JIC 37° à souder

Femmina 45° girevole JIC 37°, a saldare

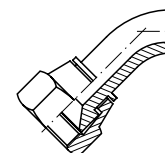

DN	THREAD ROSCA	Part nº Referencia	€
1/4"	7/16" 20h UNF	<b>A10420704</b>	<b>2,95</b>
1/4"	1/2" 20h UNF	<b>A10420804</b>	<b>3,13</b>
3/8"	9/16" 18h UNF	<b>A10420906</b>	<b>3,85</b>
1/2"	3/4" 16h UNF	<b>A10421208</b>	<b>5,46</b>
1/2"	7/8" 14h UNF	<b>A10421408</b>	<b>6,80</b>
3/4"	1" 1/16 12h UNF	<b>A10421712</b>	<b>9,13</b>
1"	1" 5/16 12h UNF	<b>A10422116</b>	<b>14,46</b>
1" 1/4	1" 5/8 12h UNF	<b>A10422620</b>	<b>27,38</b>
1" 1/2	1" 7/8 12h UNF	<b>A10423024</b>	<b>40,26</b>

# Racores soldables

Welding fittings  
Raccords à souder  
Raccordi a saldare

## Boquilla para soldar

### Welding nipple

Collet cône Métrique (DIN 2353) à souder (BW)  
o'ring

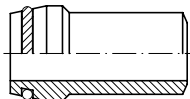

### Ogiva a saldare

PIPE TUBO	SERIE	Part n° Referencia	€
15X2.5	L	ORIL 15	*
18X2.5	L	ORIL 18	*
22X2.5	L	ORIL 22	*
28X3	L	ORIL 28	*
35X4	L	ORIL 35	*
42X3	L	ORIL 42	*
6X2	L/S	ORIS 6	*
8X2	L/S	ORIS 8	*
8X1.5	L/S	ORIS 8X1.5	*
10X2	L/S	ORIS 10X2	*
12X2	L/S	ORIS 12	*
12X2.5	S	ORIS 12X2.5	*
14X2	L/S	ORIS 14X2	*
14X3	S	ORIS 14X3	*
16X2	S	ORIS 16X2	*
16X2.5	S	ORIS 16X2.5	*
16X3	S	ORIS 16X3	*
20X2.5	S	ORIS 20X2.5	*
20X3	S	ORIS 20X3	*
20X4	S	ORIS 20X4	*
25X4	S	ORIS 25X4	*
30x4	S	ORIS 30X4	*
30x5	S	ORIS 30X5	*
38x5	S	ORIS 38X5	*

\*Ver precios en página 226 / \*See prices page 226 / \*Voir les prix page 226 / \*Vedere prezzi p. 226

## Racor recto para soldar

### Weldable straight coupling

Raccord droit à souder

### Raccordo diritto a saldare

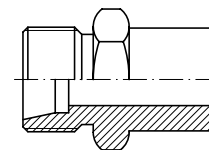

PIPE TUBO	SERIE	Part n° Referencia	€
6	L	STA ASL 6	*
8	L	STA ASL 8	*
10	L	STA ASL 10	*
12	L	STA ASL 12	*
15	L	STA ASL 15	*
18	L	STA ASL 18	*
22	L	STA ASL 22	*
28	L	STA ASL 28	*
35	L	STA ASL 35	*
42	L	STA ASL 42	*
6	S	STA ASS 6	*
8	S	STA ASS 8	*
10	S	STA ASS 10	*
12	S	STA ASS 12	*
14	S	STA ASS 14	*
16	S	STA ASS 16	*
20	S	STA ASS 20	*
25	S	STA ASS 25	*
30	S	STA ASS 30	*
38	S	STA ASS 38	*

\*Ver precios en página 226 / \*See prices page 226 / \*Voir les prix page 226 / \*Vedere prezzi p. 226

## Tuerca Métrica DIN 3870

### Nuts DIN 3870

Écrou Métrique DIN 3870

### Dadi Metrici DIN 3870

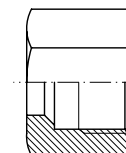

PIPE TUBO	SERIE	THREAD ROSCA	Part n° Referencia	€
4	LL	M8x1	MLL 4 M 8X1	*
6	LL	M10x1	MLL 6 M 10X1	*
8	LL	M12x1	MLL 8 M 12X1	*
6	L	M12x1,5	ML 6 M 12X1.5	*
8	L	M14x1,5	ML 8 M 14X1.5	*
10	L	M16x1,5	ML 10 M 16X1.5	*
12	L	M18x1,5	ML 12 M 18X1.5	*
15	L	M22x1,5	ML 15 M 22X1.5	*
18	L	M26x1,5	ML 18 M 26X1.5	*
22	L	M30x2	ML 22 M 30X2	*
28	L	M36x2	ML 28 M 36X2	*
35	L	M45x2	ML 35 M 45X2	*
42	L	M52x2	ML 42 M 52X2	*
6	S	M14x1,5	MS 6 M 14X1.5	*
8	S	M16x1,5	MS 8 M 16X1.5	*
10	S	M18x1,5	MS 10 M 18X1.5	*
12	S	M20x1,5	MS 12 M 20X1.5	*
14	S	M22x1,5	MS 14 M 22X1.5	*
16	S	M24x1,5	MS 16 M 24X1.5	*
20	S	M30x2	MS 20 M 30X2	*
25	S	M36x2	MS 25 M 36X2	*
30	S	M42x2	MS 30 M 42X2	*
38	S	M52x2	MS 38 M 52X2	*

\*Ver precios en página 214 / \*See prices page 214 / \*Voir les prix page 214 / \*Vedere prezzi p. 214

# Racores soldables

Welding fittings  
Raccords à souder  
Raccordi a saldare

## Hembra giratoria 45° prensada métrica - soldable

Metric weldable swivel female 45°

Femelle tournante 45° métrique à souder

Femmina girevole 45° metrica a saldare

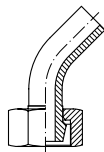

PIPE TUBO	SERIE	THREAD ROSCA	Part nº Referencia	€
6	L	12X1,5	<b>A10531206</b>	<b>4,47</b>
8	L	14x1,5	<b>A10531408</b>	<b>2,63</b>
10	L	16X1,5	<b>A10531610</b>	<b>3,31</b>
12	L	18X1,5	<b>A10531812</b>	<b>3,28</b>
15	L	22X1,5	<b>A10532215</b>	<b>4,72</b>
18	L	26X1,5	<b>A10532618</b>	<b>7,14</b>
22	L	30X2	<b>A10533022</b>	<b>9,99</b>
28	L	36X2	<b>A10533628</b>	<b>18,79</b>
35	L	45X2	<b>A10534535</b>	<b>28,90</b>
42	L	52X2	<b>A10535242</b>	<b>47,60</b>
6	S	14x1,5	<b>A10531406</b>	<b>4,47</b>
8	S	16X1,5	<b>A10531608</b>	<b>3,40</b>
10	S	18X1,5	<b>A10531810</b>	<b>3,58</b>
12	S	20X1,5	<b>A10532012</b>	<b>4,47</b>
14	S	22X1,5	<b>A10532214</b>	<b>5,19</b>
16	s	24x1,5	<b>A10532416</b>	<b>5,59</b>
20	S	30X2	<b>A10533020</b>	<b>10,89</b>
25	S	36X2	<b>A10533625</b>	<b>15,66</b>
30	S	42X2	<b>A10534230</b>	<b>24,60</b>
38	S	52X2	<b>A10535238</b>	<b>39,37</b>

## Hembra giratoria 90° prensada métrica - soldable

Metric weldable swivel female 90°

Femelle tournante 90° métrique à souder

Femmina girevole 90° metrica a saldare

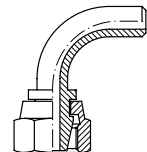

PIPE TUBO	SERIE	THREAD ROSCA	Part nº Referencia	€
6	L	12X1,5	<b>A10521206</b>	<b>4,47</b>
8	L	14X1,5	<b>A10521408</b>	<b>2,95</b>
10	L	16X1,5	<b>A10521610</b>	<b>3,31</b>
12	L	18X1,5	<b>A10521812</b>	<b>3,58</b>
15	L	22X1,5	<b>A10522215</b>	<b>5,19</b>
18	L	26X1,5	<b>A10522618</b>	<b>7,99</b>
22	L	30X2	<b>A10523022</b>	<b>11,45</b>
28	L	36X2	<b>A10523628</b>	<b>18,79</b>
35	L	45X2	<b>A10524535</b>	<b>28,81</b>
42	L	52X2	<b>A10525242</b>	<b>47,60</b>
6	S	14X1,5	<b>A10521406</b>	<b>4,47</b>
8	S	16X1,5	<b>A10521608</b>	<b>3,31</b>
10	S	18X1,5	<b>A10521810</b>	<b>3,58</b>
12	S	20X1,5	<b>A10522012</b>	<b>4,00</b>
14	S	22X1,5	<b>A10522214</b>	<b>5,19</b>
16	S	24X1,5	<b>A10522416</b>	<b>5,59</b>
20	S	30X2	<b>A10523020</b>	<b>9,73</b>
25	S	36X2	<b>A10523625</b>	<b>15,66</b>
30	S	42X2	<b>A10524230</b>	<b>24,60</b>
38	S	52X2	<b>A10525238</b>	<b>39,37</b>

# Racores soldables

Welding fittings  
Raccords à souder  
Raccordi a saldare

## Cono ajuste sin guía

Welding nipple without guide

Collet à souder sans guide

Ogiva a saldare BSP

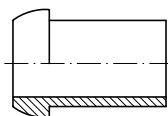

DN	THREAD ROSCA	Part nº Referencia	€
1/4"	1/4" BSP	<b>A127304</b>	<b>0,55</b>
3/8"	3/8" BSP	<b>A127306</b>	<b>0,67</b>
1/2"	1/2" BSP	<b>A127308</b>	<b>1,20</b>
3/4"	3/4" BSP	<b>A127312</b>	<b>1,33</b>
1"	1" BSP	<b>A127316</b>	<b>2,31</b>
1"1/4	1"1/4 BSP	<b>A127320</b>	<b>3,32</b>
1"1/2	1"1/2 BSP	<b>A127324</b>	<b>6,14</b>
2"	2" BSP	<b>A127332</b>	<b>9,32</b>

## Espiga lisa métrica recta

Metric standpipe

Embout lisse métrique droit

Estremità tubolare diritta Metrica

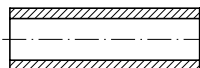

Ø OUTER Ø EXT.	Ø INNER Ø INT.	Part nº Referencia	€
10	7	<b>KL0010</b>	<b>2,76</b>
12	9	<b>KL0012</b>	<b>3,44</b>
14	10	<b>KL0014</b>	<b>3,17</b>
15	12	<b>KL0015</b>	<b>2,82</b>
16	12	<b>KL0016</b>	<b>2,96</b>
18	14	<b>KL0018</b>	<b>3,63</b>
20	14	<b>KL0020</b>	<b>4,67</b>
22	18	<b>KL0022</b>	<b>4,70</b>

## Cono ajuste BSP 60° con guía >2"

Welding nipple with 60° cone for BSP nut with guide >2"

Collet à souder BSP cone 60° avec guide >2"

Ogiva a saldare cono 60° con guida per dado BSP >2"

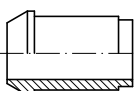

DN	THREAD ROSCA	Part nº Referencia	€
2"1/2	2"1/2 BSP	<b>Z127840</b>	*
3"	3" BSP	<b>Z127848</b>	*
4"	4" BSP	<b>Z127864</b>	*

Ver precios en Tarifa Inox p.178 / \*Prices in Stainless Steel Catalogue p.178 / Prix dans le Catalogue Acier Inox p.178 / \*Prezzi in Acciaio Inossidabile p.178

## Macho BSPT soldar microfundido AISI-316 >2"

Micro-casting BSPT welding male AISI-316 >2"

Mâle BSPT à souder en acier moulé AISI-316 >2"

Maschio BSPT a saldare microfuso AISI-316 >2"

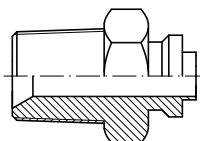

DN	THREAD ROSCA	Part nº Referencia	€
2"1/2	2"1/2 BSPT	<b>ZM103240</b>	*
3"	3" BSPT	<b>ZM103248</b>	*
4"	4" BSPT	<b>ZM103264</b>	*

\*Ver precios en Tarifa Inox p.178 / \*Prices in Stainless Steel Catalogue p.178 / \*Prix dans le Catalogue Acier Inox p.178 / \*Prezzi in Acciaio Inossidabile p.178

## Tuerca para cono ajuste 60° BSP

BSP nut for welding nipple 60° cone

Écrou BSP pour collet à souder bw (60°)

Dado BSP per nipplo a saldare 60°

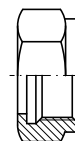

THREAD ROSCA	Part nº Referencia	€
1/4" BSP	<b>A127004</b>	<b>0,94</b>
3/8" BSP	<b>A127006</b>	<b>0,94</b>
1/2" BSP	<b>A127008</b>	<b>1,28</b>
3/4" BSP	<b>A127012</b>	<b>1,68</b>
1" BSP	<b>A127016</b>	<b>3,11</b>
1"1/4 BSP	<b>A127020</b>	<b>6,00</b>
1"1/2 BSP	<b>A127024</b>	<b>9,17</b>
2" BSP	<b>A127032</b>	<b>12,46</b>

## Tuercas BSP Microfundido AISI-316 >2"

Micro-casting BSP nuts AISI-316 >2"

Écrous BSP en acier moulé AISI-316 >2"

Dadi BSP microfusi AISI-316 >2"



THREAD ROSCA	Part nº Referencia	€
2"1/2 BSP	<b>Z127040</b>	*
3" BSP	<b>Z127048</b>	*
4" BSP	<b>Z127064</b>	*

\*Ver precios en Tarifa Inox p.178 / \*Prices in Stainless Steel Catalogue p.178 / \*Prix dans le Catalogue Acier Inox p.178 / \*Prezzi in Acciaio Inossidabile p.178

# Bridas soldables

Welding flanges  
Brides à souder  
Flange a saldare

## Brida fija DIN 2633 PN 10/16

Fixed forged flange DIN 2633 PN 10/16

Bride fixe avec collerette DIN 2633 PN 10/16 à souder

Flangia fissa a saldare DIN 2633 PN 10/16

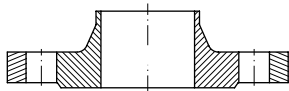

DN	Part nº Referencia	€
3/8"	<b>BPN16263306</b>	<b>16,12</b>
1/2"	<b>BPN16263308</b>	<b>16,45</b>
3/4"	<b>BPN16263312</b>	<b>24,04</b>
1"	<b>BPN16263316</b>	<b>25,33</b>
1"1/4	<b>BPN16263320</b>	<b>27,31</b>
1"1/2	<b>BPN16263324</b>	<b>39,20</b>
2"	<b>BPN16263332</b>	<b>54,23</b>
2"1/2	<b>BPN16263340</b>	<b>59,56</b>
3"	<b>BPN16263348</b>	<b>66,93</b>
4"	<b>BPN16263364</b>	<b>83,63</b>

## Brida ANSI-ASA Neck 150 LBS

Flange ANSI-ASA w. Neck 150 LBS

Bride ANSI-ASA w. Neck 150 LBS

Flangia ANSI-ASA 150 LBS

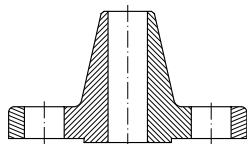

DN	Part nº Referencia	€
1/2"	<b>BANSAWN15008</b>	<b>14,24</b>
3/4"	<b>BANSAWN15012</b>	<b>16,42</b>
1"	<b>BANSAWN15016</b>	<b>19,47</b>
1"1/4	<b>BANSAWN15020</b>	<b>23,91</b>
1"1/2	<b>BANSAWN15024</b>	<b>29,25</b>
2"	<b>BANSAWN15032</b>	<b>37,44</b>
2"1/2	<b>BANSAWN15040</b>	<b>48,12</b>
3"	<b>BANSAWN15048</b>	<b>54,06</b>
4"	<b>BANSAWN15064</b>	<b>76,47</b>

## Brida fija DIN 2635 PN 40

Fixed forged flange DIN 2635 PN 40

Bride fixe avec collerette DIN 2635 PN 40 à souder

Flangia fissa a saldare DIN 2635 PN 40

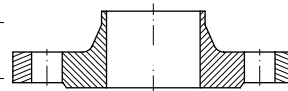

DN	Part nº Referencia	€
3/8"	<b>BPN40263506</b>	<b>3,98</b>
1/2"	<b>BPN40263508</b>	<b>7,68</b>
3/4"	<b>BPN40263512</b>	<b>10,97</b>
1"	<b>BPN40263516</b>	<b>13,29</b>
1"1/4	<b>BPN40263520</b>	<b>18,19</b>
1"1/2	<b>BPN40263524</b>	<b>22,58</b>
2"	<b>BPN40263532</b>	<b>25,48</b>
2"1/2	<b>BPN40263540</b>	<b>48,06</b>
3"	<b>BPN40263548</b>	<b>58,63</b>
4"	<b>BPN40263564</b>	<b>54,71</b>

## Brida ANSI-ASA Neck 300 LBS

Flange ANSI-ASA w. Neck 300 LBS

Bride ANSI-ASA w. Neck 300 LBS

Flangia ANSI-ASA Neck 300 LBS

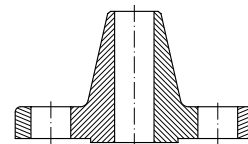

DN	Part nº Referencia	€
1/2"	<b>BANSAWN30008</b>	<b>16,55</b>
3/4"	<b>BANSAWN30012</b>	<b>22,59</b>
1"	<b>BANSAWN30016</b>	<b>25,11</b>
1"1/4	<b>BANSAWN30020</b>	<b>29,15</b>
1"1/2	<b>BANSAWN30024</b>	<b>34,38</b>
2"	<b>BANSAWN30032</b>	<b>39,84</b>
2"1/2	<b>BANSAWN30040</b>	<b>43,42</b>
3"	<b>BANSAWN30048</b>	<b>83,92</b>
4"	<b>BANSAWN30064</b>	<b>128,66</b>

# Bridas soldables

Welding flanges  
Brides à souder  
Flange a saldare

## Brida loca DIN 2642 PN 10/16

Swivel forged flange DIN 2642 PN 10/16

Bride plate tournante DIN 2642 PN 10/16 à souder

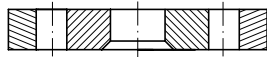

Flangia girevole a saldare DIN 2642 PN 10/16

DN	Part n° Referencia	€
3/8"	<b>BPN10264206</b>	<b>8,20</b>
1/2"	<b>BPN10264208</b>	<b>8,99</b>
3/4"	<b>BPN10264212</b>	<b>10,40</b>
1"	<b>BPN10264216</b>	<b>13,44</b>
1"1/4	<b>BPN10264220</b>	<b>17,97</b>
1"1/2	<b>BPN10264224</b>	<b>19,90</b>
2"	<b>BPN10264232</b>	<b>24,14</b>
2"1/2	<b>BPN10264240</b>	<b>26,37</b>
3"	<b>BPN10264248</b>	<b>33,27</b>
4"	<b>BPN10264264</b>	<b>37,88</b>

## Aro para brida DIN 2642

Ring for flange DIN 2642

Collet épais pour bride DIN 2642

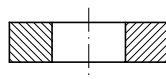

Anello per flangia DIN 2642

DN	Part n° Referencia	€
3/8"	<b>ABARO264206</b>	<b>4,61</b>
1/2"	<b>ABARO264208</b>	<b>6,01</b>
3/4"	<b>ABARO264212</b>	<b>7,24</b>
1"	<b>ABARO264216</b>	<b>11,25</b>
1"1/4	<b>ABARO264220</b>	<b>14,58</b>
1"1/2	<b>ABARO264224</b>	<b>12,40</b>
2"	<b>ABARO264232</b>	<b>19,18</b>
2"1/2	<b>ABARO264240</b>	<b>18,72</b>
3"	<b>ABARO264248</b>	<b>25,27</b>
4"	<b>ABARO264264</b>	<b>59,54</b>

## Tubo soldar brida ANSI-DIN

Tube for welding flanges ANSI-DIN

Tube à souder brides ANSI-DIN

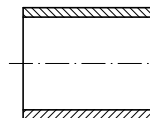

Tubo per flangia a saldare ANSI-DIN

DN	Part n° Referencia	€
3/8"	<b>ABTUB006</b>	<b>2,29</b>
1/2"	<b>ABTUB008</b>	<b>2,58</b>
3/4"	<b>ABTUB012</b>	<b>3,09</b>
1"	<b>ABTUB016</b>	<b>3,95</b>
1"1/4	<b>ABTUB020</b>	<b>5,09</b>
1"1/2	<b>ABTUB024</b>	<b>6,10</b>
2"	<b>ABTUB032</b>	<b>7,58</b>
2"1/2	<b>ABTUB040</b>	<b>9,24</b>
3"	<b>ABTUB048</b>	<b>10,50</b>
4"	<b>ABTUB064</b>	<b>12,71</b>

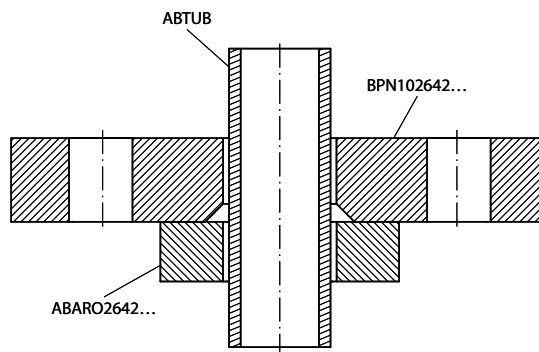

# Bridas soldables

Welding flanges  
Brides à souder  
Flange a saldare

## Brida loca DIN 2656 PN 40

Swivel forged flange DIN 2656 PN 40

Bride plate tournante DIN 2656 PN 40 à souder

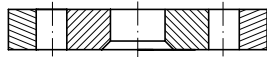

Flangia girevole a saldare DIN 2656 PN 40

DN	Part n° Referencia	€
3/8"	<b>BPN40265606</b>	<b>6,00</b>
1/2"	<b>BPN40265608</b>	<b>6,57</b>
3/4"	<b>BPN40265612</b>	<b>10,48</b>
1"	<b>BPN40265616</b>	<b>13,10</b>
1"1/4	<b>BPN40265620</b>	<b>18,12</b>
1"1/2	<b>BPN40265624</b>	<b>23,96</b>
2"	<b>BPN40265632</b>	<b>28,82</b>
2"1/2	<b>BPN40265640</b>	<b>36,60</b>
3"	<b>BPN40265648</b>	<b>30,84</b>
4"	<b>BPN40265664</b>	<b>59,85</b>

## Aro para brida DIN 2656

Ring for flange DIN 2656

Collet épais pour bride DIN 2656

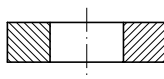

Anello per flangia DIN 2656

DN	Part n° Referencia	€
3/8"	<b>ABARO265606</b>	<b>6,09</b>
1/2"	<b>ABARO265608</b>	<b>7,55</b>
3/4"	<b>ABARO265612</b>	<b>7,24</b>
1"	<b>ABARO265616</b>	<b>9,61</b>
1"1/4	<b>ABARO265620</b>	<b>10,24</b>
1"1/2	<b>ABARO265624</b>	<b>11,94</b>
2"	<b>ABARO265632</b>	<b>19,94</b>
2"1/2	<b>ABARO265640</b>	<b>21,48</b>
3"	<b>ABARO265648</b>	<b>33,46</b>

## Tubo soldar brida ANSI-DIN

Tube for welding flanges ANSI-DIN

Tube à souder brides ANSI-DIN

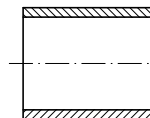

Tubo per flangia a saldare ANSI-DIN

DN	Part n° Referencia	€
3/8"	<b>ABTUB006</b>	<b>2,29</b>
1/2"	<b>ABTUB008</b>	<b>2,58</b>
3/4"	<b>ABTUB012</b>	<b>3,09</b>
1"	<b>ABTUB016</b>	<b>3,95</b>
1"1/4	<b>ABTUB020</b>	<b>5,09</b>
1"1/2	<b>ABTUB024</b>	<b>6,10</b>
2"	<b>ABTUB032</b>	<b>7,58</b>
2"1/2	<b>ABTUB040</b>	<b>9,24</b>
3"	<b>ABTUB048</b>	<b>10,50</b>
4"	<b>ABTUB064</b>	<b>12,71</b>

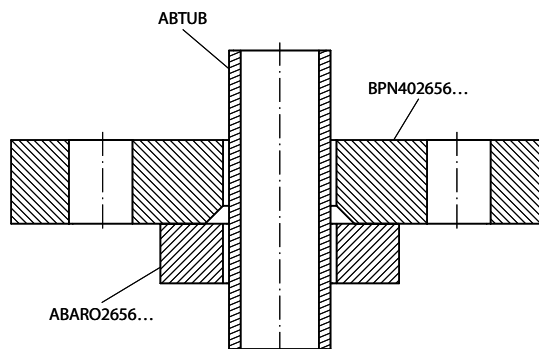

# Bridas soldables

Welding flanges  
Brides à souder  
Flange a saldare

## Brida loca ANSI-ASA 150 LBS

Swivel flange ANSI-ASA 150 LBS

Bride tourn. ANSI-ASA 150 LBS



Flangia ANSI-ASA 150 LBS

DN	Part n° Referencia	€
1/2"	<b>BANSASO15008</b>	<b>10,86</b>
3/4"	<b>BANSASO15012</b>	<b>7,77</b>
1"	<b>BANSASO15016</b>	<b>8,16</b>
1"1/4	<b>BANSASO15020</b>	<b>10,76</b>
1"1/2	<b>BANSASO15024</b>	<b>18,97</b>
2"	<b>BANSASO15032</b>	<b>30,09</b>
2"1/2	<b>BANSASO15040</b>	<b>35,55</b>
3"	<b>BANSASO15048</b>	<b>42,70</b>
4"	<b>BANSASO15064</b>	<b>105,10</b>

## Brida loca ANSI-ASA 300 LBS

Swivel flange ANSI-ASA 300 LBS

Bride tourn. ANSI-ASA 300 LBS



Flangia ANSI-ASA 300 LBS

DN	Part n° Referencia	€
1/2"	<b>BANSASO30008</b>	<b>11,50</b>
3/4"	<b>BANSASO30012</b>	<b>19,47</b>
1"	<b>BANSASO30016</b>	<b>22,31</b>
1"1/4	<b>BANSASO30020</b>	<b>17,70</b>
1"1/2	<b>BANSASO30024</b>	<b>26,58</b>
2"	<b>BANSASO30032</b>	<b>30,55</b>
2"1/2	<b>BANSASO30040</b>	<b>33,66</b>
3"	<b>BANSASO30048</b>	<b>47,17</b>
4"	<b>BANSASO30064</b>	<b>77,14</b>

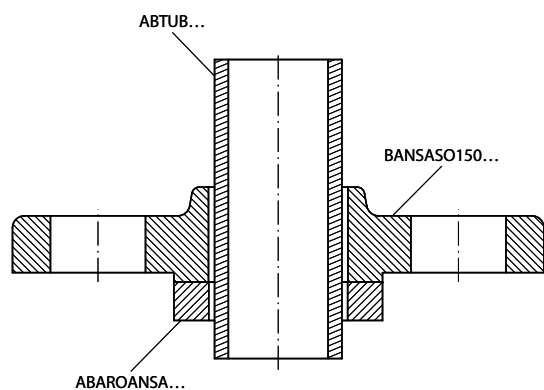

## Tube soldar brida ANSI-DIN

Tube for welding flanges ANSI-DIN

Tube à souder brides ANSI-DIN

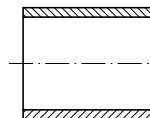

Tube per flangia a saldare ANSI-DIN

DN	Part n° Referencia	€
3/8"	<b>ABTUB006</b>	<b>2,29</b>
1/2"	<b>ABTUB008</b>	<b>2,58</b>
3/4"	<b>ABTUB012</b>	<b>3,09</b>
1"	<b>ABTUB016</b>	<b>3,95</b>
1"1/4	<b>ABTUB020</b>	<b>5,09</b>
1"1/2	<b>ABTUB024</b>	<b>6,10</b>
2"	<b>ABTUB032</b>	<b>7,58</b>
2"1/2	<b>ABTUB040</b>	<b>9,24</b>
3"	<b>ABTUB048</b>	<b>10,50</b>
4"	<b>ABTUB064</b>	<b>12,71</b>

## Aro para brida ANSI-ASA 150/300 LBS

Ring for welding flanges ANSI-ASA 150/300 LBS

Collet épais pour bride ANSI-ASA 150/300 LBS

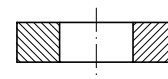

Anello per flangia ANSI-ASA 150/300 LBS

DN	Part n° Referencia	€
1/2"	<b>ABAROANSA08</b>	<b>3,28</b>
3/4"	<b>ABAROANSA12</b>	<b>3,94</b>
1"	<b>ABAROANSA16</b>	<b>6,62</b>
1"1/4	<b>ABAROANSA20</b>	<b>5,89</b>
1"1/2	<b>ABAROANSA24</b>	<b>7,48</b>
2"	<b>ABAROANSA32</b>	<b>11,92</b>
2"1/2	<b>ABAROANSA40</b>	<b>16,01</b>
3"	<b>ABAROANSA48</b>	<b>21,01</b>
4"	<b>ABAROANSA64</b>	<b>33,57</b>

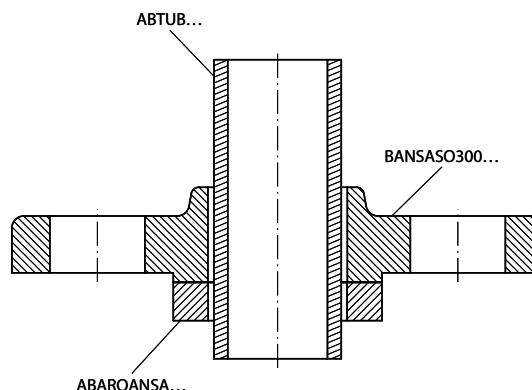

## Baja presión

*Low pressure*

Basse pression

*Tubi a bassa pressione*

### **Mangueras baja presión**

*Low pressure hoses*

Tuyaux basse pression

*Tubi bassa pressione*

183

### **Racores baja presión**

*Low pressure fittings*

Raccords basse pression

*Raccordi bassa pressione*

184

4

## Mangueras baja presión

*Low pressure hoses*  
*Tuyaux basse pression*  
*Tubi bassa pressione*

- Mangueras de caucho sintético / Synthetic rubber hoses (diesel oil) / Tuyaux de caoutchouc synthétique (gas-oil) / Tubi di caucciú sintético (diesel) | 183



M100



M110

## Racores baja presión

*Low pressure fittings*  
*Raccords basse pression*  
*Raccordi bassa pressione*

- Casquillos (campanillas) / Sleeves / Jupes basse pression / Boccole | 184



A5010



ALCA

- Conexiones BSP / BSP Fittings / Embouts BSP basse pression / Raccordi BSP | 184



D5042



D5040



D5052



D5050



D5030



D5091

- Conexiones Métricas / Metric fittings / Embouts Métriques basse pression / Raccordi Metrici | 186



D5062



D5082



D5080



D5060



D5070



D5090



D5085



D5020

# Mangueras baja presión

Low pressure hoses  
Tuyaux basse pression  
Tubi bassa pressione

## Manguera de caucho sintético con una malla de acero galvanizado (gasoil)

Synthetic rubber hose with a galvanized steel braided (gasoil)

Tuyau de caoutchouc synthétique avec une tresse d'acier galvanisé (gasoil)

Tubo di caucciú sintético con una treccia di acciaio galvanizzato (gasolio)



Ø INNER Ø INT.	Part nº Referencia	€
5	M10005	4,73
6	M10006	5,46
7	M10007	5,80
8	M10008	6,59
9	M10009	7,49
12	M10012	10,73
14	M10014	12,10
15	M10015	14,11
18	M10018	17,77
20	M10020	18,85
22	M10022	21,41
26	M10025	24,99
30	M10030	31,48
40	M10040	77,24
50	M10050	102,69

## Manguera de caucho sintético con una malla textil de alta tenacidad (gasoil y gasolina)

Synthetic rubber hose with a textile braided high toughness (gasoil and gasolina)

Tuyau de caoutchouc synthétique avec une tresse textile d'haute tenacité (gasoil et essence)

Tubo di caucciú sintético con una treccia tessile ad alta resistenza (gasolio e benzina)



Ø INNER Ø INT.	Part nº Referencia	€
4	M11004	4,40
5	M11005	4,80
6	M11006	5,56
7	M11007	6,25
8	M11008	6,08
9	M11009	7,76
12	M11012	11,81

## Máquina prensar baja presión | Low pressure crimping machine | Presse basse pression | Macchina pressatubi bassa pressione

PBPH25PI



PBPH25



**Mordazas incluidas** | Included dies | Mors inclus | Morsetti inclusi  
Ø10-13-16 mm.

Ø máx. | Ø max. | Ø max. | Ø massimo

25 mm. 25 mm.

**Apertura** | Opening | Overture | Apertura

+21 mm. +21 mm.

**Peso** | Weight | Poids | Peso

25 kg. 12 kg.

**Dimensiones** | Dimensions | Dimensions | Dimensioni

500 x 180 x 310 mm.

**Alimentación neumática** | Pneumatic input |

Alimentation Pneumatique | Alimentazione pneumatica

Máx. 7 bar.

**Mordazas incluidas** | Included dies | Mors inclus | Morsetti inclusi  
Ø10-13-16 mm.

Ø máx. | Ø max. | Ø max. | Ø massimo

**Apertura** | Opening | Overture | Apertura

**Peso** | Weight | Poids | Peso

**Dimensiones** | Dimensions | Dimensions | Dimensioni

500 x 180 x 310 mm.

# Racores baja presión

Low pressure fittings  
Raccords basse pression  
Raccordi bassa pressione

## Campana acero para manguera de baja presión

Sleeves for low pressure hose (steel)

Jupe acier doux malléable pour tuyau basse pression

Boccola in acciaio sottile per tubo bassa pressione



Ø OUTER Ø EXT.	Ø INNER Ø INT.	Part n° Referencia	€
11,6	10,5	A50101050000	0,28
13,7	12,4	A50101200000	0,32
14,7	13,5	A50101350000	0,35
15,6	14,5	A50101450000	0,35
16,5	15,5	A50101550000	0,38
18,8	17,3	A50101700000	0,44
19,5	18,5	A50101850000	0,46
22,9	20,5	A50102050000	0,56
23,9	22,5	A50102250000	0,64
26,2	24,5	A50102450000	0,73
28	26,4	A50102600000	0,74
30	28	A50102800000	0,90
32,2	30	A50103000000	1,44
35,5	33,5	A50103300000	1,46
38,2	36	A50103600000	1,61
45,2	42,2	A50104200000	5,30
60,8	56	A50105600000	6,55
65,5	61	A50106100000	8,28
70,3	66,5	A50106650000	11,33
76,7	71	A50107100000	12,68

## Campana aluminio para racor industrial - cierre 45°

Crimping ferrule 45° closure (aluminium)

Jupe aluminium pour raccord industriel - fermeture 45°

Boccola alluminio per raccordo industriale - chiusura 45°



Ø INNER Ø INT.	Part n° Referencia	€
11	ALCA011000	*
12.9	ALCA012900	*
13.4	ALCA013400	*
14.5	ALCA014500	*
15.5	ALCA015500	*
17.5	ALCA017500	*
18.5	ALCA018500	*
20.5	ALCA020500	*
21.5	ALCA021500	*
24.5	ALCA024500	*
26.5	ALCA026500	*
28.5	ALCA028500	*
30	ALCA030000	*
33	ALCA033000	*
36	ALCA036000	*
39	ALCA039000	*
46	ALCA046000	*
43	ALCA043000	*
48	ALCA048000	*
50	ALCA050000	*
54	ALCA054000	*
56.5	ALCA056500	*
63	ALCA063000	*
67	ALCA067000	*
84	ALCA083000	*
98	ALCA099000	*
123	ALCA121000	*

\*Ver precios en p.160 / \*See prices in p.160 / \*Prix à la p.160 / \*Vedere prezzi p.160

## Macho BSP rosca cilíndrica asiento cónico 60°

BSP Cylindrical male low pressure 60° cone

Embout mâle fixe BSP cône 60° basse pression

Maschio BSP cilindrica sede conica 60° bassa pressione



PIPE TUBO	THREAD ROSCA	Part n° Referencia	€
5-6	1/4"	D50420405000	2,38
7-8	1/4"	D50420407000	2,57
7-8	3/8"	D50420607000	2,47
9-10	3/8"	D50420609000	2,75
12-13	3/8"	D50420612000	3,07
12-13	1/2"	D50420812000	4,38
15-16	1/2"	D50420815000	3,16
15-16	3/4"	D50421216000	5,17
19-20	3/4"	D50421220000	5,03
19-20	1"	D50421620000	7,76
25	1"	D50421625000	6,89
30	1"1/4	D50422030000	20,89
40	1"1/2	D50422440000	27,64
50	2"	D50423250000	34,81

## Macho BSP rosca cilíndrica asiento plano

Low pressure BSP cylindrical male flat seat

Embout mâle gaz fond plat basse pression

Maschio BSP cilindrico sede piana bassa pressione



PIPE TUBO	THREAD ROSCA	Part n° Referencia	€
5-6	1/8"	D50400205000	1,70
5-6	1/4"	D50400405000	2,38
7-8	1/4"	D50400407000	2,38
7-8	3/8"	D50400607000	2,46
9-10	3/8"	D50400609000	2,46
12-13	1/2"	D50400812000	3,16
15-16	1/2"	D50400815000	3,16
15-16	3/4"	D50401216000	5,17
19-20	3/4"	D50401220000	4,66
19-20	1"	D50401620000	7,76
25	1"	D50401625000	7,11
30	1"1/4	D50402030000	21,08
40	1"1/2	D50402440000	25,29
50	2"	D50403250000	34,81

# Racores baja presión

Low pressure fittings  
Raccords basse pression  
Raccordi bassa pressione

## Boquilla asiento cónico 60° (BSP) baja presión

BSP Nipple 60° cone low pressure

Nipple embout femelle BSP 60° basse pression

Inserto cono 60° BSP bassa pressione



DN	NUT TUERCA	Part nº Referencia	€
5-6	1/4"	D50520405000	1,30
7-8	1/4"	D50520407000	1,11
7-8	3/8"	D50520607000	1,33
9-10	3/8"	D50520609000	1,31
12-13	1/2"	D50520812000	1,64
15-16	1/2"	D50520815000	2,01
15-16	3/4"	D50521216000	2,22
19-20	3/4"	D50521220000	2,37
19-20	1"	D50521620000	4,24
25	1"	D50521625000	3,77
30	1"1/4	D50522030000	8,20
40	1"1/2	D50522440000	13,39
50	2"	D50523250000	21,71

## Boquilla asiento plano (BSP) baja presión

BSP Nipple flat seat

Nipple embout femelle fond plat BSP basse pression

Inserto faccia piana BSP bassa pressione



PIPE TUBO	NUT TUERCA	Part nº Referencia	€
5-6	1/4"	D50500405000	1,30
7-8	1/4"	D50500407000	1,30
9-10	3/8"	D50500609000	1,33
12-13	1/2"	D50500812000	1,61
15-16	1/2"	D50500815000	1,77
15-16	3/4"	D50501216000	2,22
19-20	3/4"	D50501220000	2,05
19-20	1"	D50501620000	4,24
25	1"	D50501625000	3,77
30	1"1/4	D50502030000	8,52
40	1"1/2	D50502440000	16,44
50	2"	D50503250000	21,71

## Tuerca BSP

BSP Nut

Ecrou BSP

Dado BSP



THREAD ROSCA	Part nº Referencia	€
1/4" BSP	D50300400000	0,84
3/8" BSP	D50300600000	0,90
1/2" BSP	D50300800000	1,44
3/4" BSP	D50301200000	1,95
1" BSP	D50301600000	3,41
1"1/4 BSP	D50302000000	7,51
1"1/2 BSP	D50302400000	8,88
2" BSP	D50303200000	16,58

## Codo 90° baja gas cono 60°

90° BSP Swivel female 60° cone low pressure

Embout femelle 90° gaz cyl BSP 60° basse pression

Femmina a 90° sede 60° bassa pressione



PIPE TUBO	THREAD ROSCA	Part nº Referencia	€
5-6	1/4"	D50910405000	6,07
7-8	1/4"	D50910407000	5,02
9-10	3/8"	D50910609000	6,21
12-13	1/2"	D50910812000	8,91
15-16	1/2"	D50910815000	9,26
15-16	3/4"	D50911216000	17,90
19-20	3/4"	D50911220000	16,71
19-20	1"	D50911620000	27,94
25	1"	D50911625000	19,87
30	1"1/4	D50912030000	63,62

# Racores baja presión

Low pressure fittings  
Raccords basse pression  
Raccordi bassa pressione

## Macho rosca métrica asiento cónico 60° baja presión

Metric cylindrical male 60° cone

Embout mâle DIN métrique cône 60° basse pression



Maschio Metrico sede conica 60° bassa pressione

PIPE TUBO	THREAD ROSCA	Part nº Referencia	€
5-6	10X1	D50621005000	2,38
7-8	12X1,5	D50621207000	2,60
9-10	14X1,5	D50621409000	2,86
9-10	16X1,5	D50621609000	3,22
12-13	16X1,5	D50621612000	3,64
9-10	18X1,5	D50621810000	3,78
12-13	22X1,5	D50622212000	4,69
15-16	22X1,5	D50622215000	4,85
12-13	26X1,5	D50622612000	5,41
15-16	26X1,5	D50622615000	5,41

## Macho rosca métrica asiento plano baja presión

Metric cyl male flat seat low pressure

Embout mâle métrique fond plat basse pression



Maschio Metrico sede piana bassa pressione

PIPE TUBO	THREAD ROSCA	Part nº Referencia	€
5-6	10X1	D50601005000	2,39
7-8	12X1,5	D50601207000	2,60
9-10	14X1,5	D50601409000	2,86
9-10	16X1,5	D50601609000	3,25
12-13	16X1,5	D50601612000	3,61
9-10	18X1,5	D50601810000	4,00
12-13	22X1,5	D50602212000	3,79
15-16	22X1,5	D50602215000	3,37
12-13	26X1,5	D50602612000	5,41
15-16	26X1,5	D50602615000	5,41

## Boquilla asiento cónico 60° (Métrica) baja presión

Metric nipple 60° cone low pressure

Nipple pour embout femelle DIN métrique cône 60° basse pression



Inserto cono 60° Metrico bassa pressione

PIPE TUBO	NUT TUERCA	Part nº Referencia	€
5-6	10X1	D50821005000	1,39
7-8	12X1,5	D50821207000	1,60
9-10	14X1,5	D50821409000	1,60
8-9	16X1,5	D50821609000	1,72
9-10	18X1,5	D50821810000	2,10
12-13	22X1,5	D50822212000	2,52
15-16	22X1,5	D50822215000	2,52
12-13	26X1,5	D50822612000	3,86
15-16	26X1,5	D50822615000	3,86

## Boquilla asiento plano (Métrica) baja presión

Metric nipple flat seat low pressure

Nipple pour embout femelle métrique fond plat basse pression



Inserto faccia piana bassa pressione

PIPE TUBO	NUT TUERCA	Part nº Referencia	€
5-6	10X1	D50801005000	1,39
7-8	12X1,5	D50801207000	1,54
9-10	14X1,5	D50801409000	1,60
9-10	16X1,5	D50801609000	1,42
9-10	18X1,5	D50801810000	2,22
12-13	22X1,5	D50802212000	2,52
15-16	22X1,5	D50802215000	1,68
12-13	26X1,5	D50802612000	3,86
15-16	26X1,5	D50802615000	3,86

## Tuerca Métrica

Metric nut

Écrou métrique



Dado Metrico

THREAD ROSCA	Part nº Referencia	€
10X1	D50701000000	0,98
12X1,5	D50701200000	1,11
14X1,5	D50701400000	1,39
16X1,5	D50701600000	1,39
18X1,5	D50701800000	1,62
22X1,5	D50702200000	2,68
26X1,5	D50702600000	3,10

## Boquilla en codo 90° asiento cónico 60° (métrica) baja presión

Nipple in 90° metric swivel female tapered seat low pressure 60°

Nipple en embout femelle 90° DIN métrique cône 60° basse pression



Femmina a 90° Metrica sede conica 60°

PIPE TUBO	THREAD ROSCA	Part nº Referencia	€
5-6	10X1	D50901006000	6,93
7-8	12X1,5	D50901207000	10,55
9-10	14X1,5	D50901409000	8,44
9-10	16X1,5	D50901609000	8,45

# Racores baja presión

Low pressure fittings  
Raccords basse pression  
Raccordi bassa pressione

## Espiga lisa métrica baja presión

Metric standpipe low pressure

Embout lisse métrique basse pression



Estremità tubolare Metrica bassa pressione

PIPE TUBO		Part nº Referencia	€
5-6	4	<b>D50850405000</b>	<b>5,14</b>
5-6	6	<b>D50850606000</b>	<b>2,93</b>
5-6	8	<b>D50850806000</b>	<b>2,93</b>
7-8	8	<b>D50850808000</b>	<b>2,93</b>
7-8	10	<b>D50851008000</b>	<b>3,15</b>
9-10	10	<b>D50851010000</b>	<b>3,15</b>
12-13	12	<b>D50851212000</b>	<b>3,31</b>
15,5	15	<b>D50851515000</b>	<b>5,22</b>
15-16	18	<b>D50851815000</b>	<b>5,50</b>

## Orientable métrico baja presión

Low pressure metric banjo

Embout banjo métrique basse pression



Raccordo ad occhio Metrico bassa pressione

PIPE TUBO	Ø	Part nº Referencia	€
5-6	8	<b>D50200805</b>	<b>4,03</b>
7-8	8	<b>D50200807</b>	<b>4,03</b>
5-6	10	<b>D50201005</b>	<b>4,42</b>
7-8	10	<b>D50201007</b>	<b>4,42</b>
9-10	10	<b>D50201009</b>	<b>4,49</b>
5-6	12	<b>D50201205</b>	<b>4,60</b>
7-8	12	<b>D50201207</b>	<b>4,60</b>
9-10	12	<b>D50201209</b>	<b>4,60</b>
5-6	14	<b>D50201405</b>	<b>4,74</b>
7-8	14	<b>D50201407</b>	<b>4,74</b>
9-10	14	<b>D50201409</b>	<b>4,74</b>

## Aire acondicionado

*Air conditioning hoses and fittings*

Climatisation

*Aria condizionata*

### **Manguera aire acondicionado**

*Air conditioning hose*

Tuyau Freon

*Tube Freon*

193

### **Racores aire acondicionado**

*Air conditioning fittings*

Raccords climatisation

*Raccordi aria condizionata*

194

5

# Manguera aire acondicionado

*Air conditioning hose*

Tuyau Freon

Tube Freon

- Mangueras Freón / Air conditioning hose / Tuyau Freon / Tubo Freon



M5200



MSB25

# Racores aire acondicionado

Air conditioning fittings  
Raccords climatisation  
Raccordi aria condizionata

- Rotalock sin válvula / Rotalock without valve / Raccords Rotalock sans vanne / Raccordi Rotalock senza valvola | 194



- Rotalock con válvula / Rotalock with valve / Raccords Rotalock avec vanne / Raccordi Rotalock con valvola | 194



- Racores de unión / Couplings / Raccord union / Raccordi di unione | 194



- Hembras con junta tórica sin válvula / Swivel female with green joint / Femelles tournantes avec joint vert sans vanne / Femmine con o'ring senza valvola | 195



- Hembras con junta tórica con válvula / Swivel female with green joint with valve / Femelles tournantes avec joint vert et avec vanne / Femmine con o'ring e valvola | 195



- Machos con junta tórica / Males with green joint / Mâles avec joint vert / Maschi con o'ring | 196



- Conexiones rosca SAE / Swivel females SAE / Femelles tournantes SAE / Raccordi SAE | 196



- Conexiones con válvula para Freón 12 / Fittings with valve for air conditioning 12 / Embouts climatisation pour Freón 12 avec vanne / Raccordi con valvola per Freon 12 | 197



## Racores aire acondicionado

*Air conditioning fittings*  
*Raccords climatisation*  
*Raccordi aria condizionata*

- Juntas tóricas y racores recuperables / Joints and reusable fittings / Joints toriques et raccords récupérables / O'ring e raccordi recuperabili



\*FREON



CRF

# Manguera aire acondicionado

Air conditioning hose

Tuyau Freon

Tube Freon

Industrial hoses

Industrial fittings

Stainless steel hose, welding fittings and flanges

Low pressure

Air conditioning hoses and fittings

## Freón DAYCO

Air conditioning DAYCO

Tuyaux Freon DAYCO

Freon DAYCO



DN		Part nº Referencia	€
5/16"	8	<b>M520006</b>	<b>15,58</b>
13/32"	10	<b>M520008</b>	<b>21,65</b>
1/2"	13	<b>M520010</b>	<b>24,89</b>
5/8"	16	<b>M520012</b>	<b>31,43</b>

## Freón TrΔle

Air conditioning TrΔle

Tuyaux Freon TrΔle

Freon TrΔle



DN		Part nº Referencia	€
5/16"	8	<b>MSB2506</b>	<b>12,90</b>
13/32"	10	<b>MSB2508</b>	<b>13,20</b>
1/2"	12	<b>MSB2510</b>	<b>15,30</b>
5/8"	16	<b>MSB2512</b>	<b>16,50</b>

## Mangueras Freón Barrier N (polivalente) Freón 134, 12...

Air Conditioning Barrier N Hose Freon 134, 12...



SAE J51  
SAE J2064



-30 / 95 °C

- Está compuesta por Nitrilo, Nylon y Neopreno. Cubierta exterior de EPDM resistente al calor, abrasión y al exterior.

Tube: Nitrile, Nylon and Neoprene. Outer cover of EPDM, heat, abrasion and ozone resistant.

- Refrigerantes / refrigerants  
HFC-134a / CFC-12

- Prensas eléctricas  
Electric crimping machine

- Prensa manual  
Manual crimping machine

- Prensa Freón. Ref. V001040 (sin juegos de mordazas)  
Air conditioning hose crimping machine (without clamps)

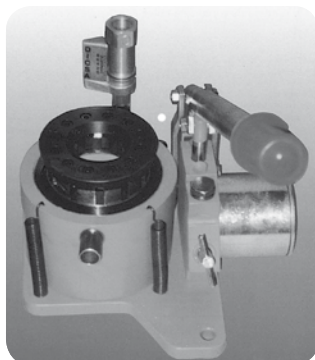

Disponemos de garras de freón para las prensas  
SE 25 - PE 25 / 28 / 32 / 38 / 50 / 58 / 4-50 - PE 180 - PES 50...  
We have air conditioning clamps for the following machines  
SE 25 - PE 25 / 28 / 32 / 38 / 50 / 58 / 4-50 - PE 180 - PES 50...

# Racores aire acondicionado

Air conditioning fittings  
Raccords climatisation  
Raccordi aria condizionata

## Hembra recta con junta Rotalock

*Straight female with Rotalock joint*

Femelle climatisation droite Rotalock avec raccord tube "o" compresseur



*Femmina diritta con guarnizione Rotalock*

DN	THREAD ROSCA	Part n° Referencia	€
13/32"	1" 14h UNS	<b>FXR 1108</b>	<b>12,88</b>
1/2"	1" 14h UNS	<b>FXR 1110</b>	<b>13,34</b>
5/8"	1" 14h UNS	<b>FXR 1112</b>	<b>19,17</b>

## Hembra 45° con junta Rotalock

*45° Female with Rotalock joint*

Femelle climatisation 45° Rotalock avec raccord tube 45° "o" compresseur



*Femmina a 45° con guarnizione Rotalock*

DN	THREAD ROSCA	Part n° Referencia	€
13/32"	1" 14h UNS	<b>FX45 1108</b>	<b>14,26</b>
1/2"	1" 14h UNS	<b>FX45 1110</b>	<b>15,34</b>
5/8"	1" 14h UNS	<b>FX45 1112</b>	<b>21,78</b>

## Hembra 90° con junta Rotalock

*90° Female with Rotalock joint*

Femelle climatisation 90° Rotalock avec raccord tube 90° "o" compresseur



*Femmina a 90° con guarnizione Rotalock*

DN	THREAD ROSCA	Part n° Referencia	€
13/32"	1" 14h UNS	<b>FX90 1108</b>	<b>14,42</b>
1/2"	1" 14h UNS	<b>FX90 1110</b>	<b>15,34</b>
5/8"	1" 14h UNS	<b>FX90 1112</b>	<b>21,93</b>

## Hembra especial 90° con junta Rotalock

*90° Special female with Rotalock joint*

Femelle climatisation spéciale 90° Rotalock avec raccord tube 90° spécial "o" compresseur



*Femmina a 90° speciale con guarnizione Rotalock*

DN	THREAD ROSCA	Part n° Referencia	€
13/32"	1" 14h UNS	<b>FXA90 1108</b>	<b>22,55</b>
1/2"	1" 14h UNS	<b>FXA90 1110</b>	<b>22,85</b>

## Hembra recta con junta Rotalock y válvula 134

*Straight female with Rotalock joint and 134 valve*

Femelle droite Rotalock avec joint et vanne pour 134



*Femmina diritta con guarnizione Rotalock e valvola 134*

DN	THREAD ROSCA	Part n° Referencia	€
13/32"	1" 14h UNS	<b>134 FXRV 1108</b>	<b>23,47</b>
1/2"	1" 14h UNS	<b>134 FXRV 1110</b>	<b>24,08</b>
5/8"	1" 14h UNS	<b>134 FXRV 1112</b>	<b>26,53</b>

## Hembra 90° con junta Rotalock y válvula 134

*90° Female with Rotalock joint and 134 valve*

Femelle 90° Rotalock avec joint et vanne pour 134



*Femmina a 90° con guarnizione Rotalock e valvola 134*

DN	THREAD ROSCA	Part n° Referencia	€
13/32"	1" 14h UNS	<b>134 FX90V 1108</b>	<b>24,69</b>
1/2"	1" 14h UNS	<b>134 FX90V 1110</b>	<b>25,31</b>
5/8"	1" 14h UNS	<b>134 FX90V 1112</b>	<b>29,29</b>

## Hembra 45° con junta Rotalock y válvula 134

*45° Female with Rotalock joint and 134 valve*

Femelle 45° Rotalock avec joint et vanne pour 134



*Femmina a 45° con guarnizione Rotalock e valvola 134*

DN	THREAD ROSCA	Part n° Referencia	€
13/32"	1" 14h UNS	<b>134 FX45V 1108</b>	<b>26,23</b>
1/2"	1" 14h UNS	<b>134 FX45V 1110</b>	<b>25,15</b>

## Hembra especial 90° con junta Rotalock y válvula 134

*90° special Female with Rotalock joint and 134 valve*

Femelle climatisation spéciale 90° Rotalock avec joint et vanne pour 134



*Femmina a 90° speciale con guarnizione Rotalock e valvola 134*

DN	THREAD ROSCA	Part n° Referencia	€
13/32"	1" 14h UNS	<b>134 FXAV90 1108</b>	<b>30,06</b>
1/2"	1" 14h UNS	<b>134 FXAV90 1110</b>	<b>30,37</b>

## Racor de unión con válvula 134

*134 valve coupling*

Raccord d'union climatisation avec vanne pour splicer vanne pour 134



*Raccordo di unione tubi con valvola 134*

DN	Part n° Referencia	€
5/16"	<b>134 URTV 0006</b>	<b>23,77</b>
13/32"	<b>134 URTV 0008</b>	<b>25,31</b>
1/2"	<b>134 URTV 0010</b>	<b>25,46</b>
5/8"	<b>134 URTV 0012</b>	<b>25,77</b>

## Racor de unión

*Hose-hose coupling*

Raccord d'union climatisation splicer



*Raccordo di unione tubo-tubo*

DN	Part n° Referencia	€
5/16"	<b>URT 0006</b>	<b>10,89</b>
13/32"	<b>URT 0008</b>	<b>11,20</b>
1/2"	<b>URT 0010</b>	<b>12,73</b>
5/8"	<b>URT 0012</b>	<b>13,34</b>

# Racores aire acondicionado

Air conditioning fittings  
Raccords climatisation  
Raccordi aria condizionata

## Hembra giratoria recta con junta verde

*Straight swivel female with green joint*

Femelle tournante avec joint vert

*Femmina diritta con o'ring verde*



DN	THREAD ROSCA	Part n° Referencia	€
5/16"	5/8" 18h UNF	<b>FOR 0606</b>	<b>9,05</b>
13/32"	3/4" 16h UNF	<b>FOR 0808</b>	<b>9,66</b>
1/2"	7/8" 14h UNF	<b>FOR 1010</b>	<b>11,04</b>
5/8"	7/8" 14h UNF	<b>FOR 1012</b>	<b>12,27</b>
5/8"	1"1/16 12h UNF	<b>FOR 1212</b>	<b>14,57</b>

## Hembra giratoria 45° con junta verde

*45° swivel female with green joint*

Femelle tournante 45° avec joint vert

*Femmina a 45° con o'ring verde*



DN	THREAD ROSCA	Part n° Referencia	€
5/16"	5/8" 18h UNF	<b>FO45 0606</b>	<b>9,97</b>
13/32"	3/4" 16h UNF	<b>FO45 0808</b>	<b>10,89</b>
1/2"	7/8" 14h UNF	<b>FO45 1010</b>	<b>11,81</b>
5/8"	7/8" 14h UNF	<b>FO45 1012</b>	<b>12,88</b>
5/8"	1"1/16 12h UNF	<b>FO45 1212</b>	<b>15,64</b>

## Hembra giratoria recta con válvula

*Straight swivel female with green joint and valve*

Femelle tournante avec joint vert et vanne pour 134

*Femmina diritta con o'ring verde e valvola 134*



DN	THREAD ROSCA	Part n° Referencia	€
5/16"	5/8" 18h UNF	<b>FORV 0606</b>	<b>19,63</b>
13/32"	3/4" 16h UNF	<b>FORV 0808</b>	<b>20,25</b>
1/2"	7/8" 14h UNF	<b>FORV 1010</b>	<b>20,86</b>
5/8"	7/8" 14h UNF	<b>FORV 1012</b>	<b>22,09</b>
5/8"	1"1/16 12h UNF	<b>FORV 1212</b>	<b>25,00</b>

## Hembra giratoria 90° con válvula

*90° Swivel female with green joint and valve*

Femelle tournante 90° avec joint vert et vanne pour 134

*Femmina a 90° con o'ring verde e valvola 134*



DN	THREAD ROSCA	Part n° Referencia	€
5/16"	5/8" 18h UNF	<b>FO90V 0606</b>	<b>21,78</b>
13/32"	3/4" 16h UNF	<b>FO90V 0808</b>	<b>22,70</b>
1/2"	7/8" 14h UNF	<b>FO90V 1010</b>	<b>22,85</b>
5/8"	7/8" 14h UNF	<b>FO90V 1012</b>	<b>22,85</b>
5/8"	1"1/16 12h UNF	<b>FO90V 1212</b>	<b>27,61</b>

## Hembra giratoria 90° con junta verde

*90° swivel female with green joint*

Femelle tournante 90° avec joint vert

*Femmina a 90° con o'ring verde*



DN	THREAD ROSCA	Part n° Referencia	€
5/16"	5/8" 18h UNF	<b>FO90 0606</b>	<b>10,28</b>
13/32"	3/4" 16h UNF	<b>FO90 0808</b>	<b>10,89</b>
1/2"	7/8" 14h UNF	<b>FO90 1010</b>	<b>11,81</b>
5/8"	7/8" 14h UNF	<b>FO90 1012</b>	<b>12,88</b>
5/8"	1"1/16 12h UNF	<b>FO90 1212</b>	<b>15,64</b>

## Hembra giratoria 45° con válvula

*45° Swivel female with green joint and valve*

Femelle tournante 45° avec joint vert et vanne pour 134

*Femmina a 45° con o'ring verde e valvola 134*



DN	THREAD ROSCA	Part n° Referencia	€
5/16"	5/8" 18h UNF	<b>FO45V 0606</b>	<b>20,71</b>
13/32"	3/4" 16h UNF	<b>FO45V 0808</b>	<b>21,63</b>
1/2"	7/8" 14h UNF	<b>FO45V 1010</b>	<b>22,09</b>
5/8"	7/8" 14h UNF	<b>FO45V 1012</b>	<b>22,85</b>
5/8"	1"1/16 12h UNF	<b>FO45V 1212</b>	<b>27,45</b>

# Racores aire acondicionado

Air conditioning fittings  
Raccords climatisation  
Raccordi aria condizionata

## Macho recto con junta tórica

*Straight male with green joint*

*Mâle tournant avec joint vert*



*Maschio diritto con o'ring*

DN	THREAD ROSCA	Part n° Referencia	€
5/16"	5/8" 18h UNF	<b>MOR 0606</b>	<b>9,05</b>
13/32"	3/4" 18h UNF	<b>MOR 0808</b>	<b>9,66</b>
1/2"	7/8" 18h UNF	<b>MOR 1010</b>	<b>11,50</b>
5/8"	7/8" 18h UNF	<b>MOR 1012</b>	<b>13,25</b>
5/8"	1"1/16 16h UNF	<b>MOR 1212</b>	<b>14,88</b>

## Macho 90° con junta tórica

*90° Male with green joint*

*Mâle tournant 90° avec joint vert*



*Maschio a 90° con o'ring*

DN	THREAD ROSCA	Part n° Referencia	€
5/16"	5/8" 18h UNF	<b>MO90 0606</b>	<b>10,28</b>
13/32"	3/4" 18h UNF	<b>MO90 0808</b>	<b>11,04</b>
1/2"	7/8" 18h UNF	<b>MO90 1010</b>	<b>12,58</b>
5/8"	7/8" 18h UNF	<b>MO90 1012</b>	<b>14,11</b>
5/8"	1"1/16 16h UNF	<b>MO90 1212</b>	<b>16,26</b>

## Macho 45° con junta tórica

*45° Male with green joint*

*Mâle tournant 45° avec joint vert*



*Maschio a 45° con o'ring*

DN	THREAD ROSCA	Part n° Referencia	€
5/16"	5/8" 18h UNF	<b>MO45 0606</b>	<b>10,28</b>
13/32"	3/4" 18h UNF	<b>MO45 0808</b>	<b>10,89</b>
1/2"	7/8" 18h UNF	<b>MO45 1010</b>	<b>12,27</b>
5/8"	7/8" 18h UNF	<b>MO45 1012</b>	<b>14,11</b>
5/8"	1"1/16 16h UNF	<b>MO45 1212</b>	<b>16,10</b>

## Hembra giratoria recta SAE

*Straight swivel female SAE*

*Femelle tournante SAE droite*



*Femmina diritta SAE*

DN	THREAD ROSCA	Part n° Referencia	€
5/16"	5/8" 18h UNF	<b>FSR 0606</b>	<b>11,96</b>
13/32"	3/4" 16h UNF	<b>FSR 0808</b>	<b>13,04</b>
1/2"	7/8" 14h UNF	<b>FSR 1010</b>	<b>14,57</b>

## Codo 45° hembra giratoria SAE

*45° Swivel female SAE*

*Femelle tournante 45° SAE*



*Femmina a 45° SAE*

DN	THREAD ROSCA	Part n° Referencia	€
5/16"	5/8" 18h UNF	<b>FS45 0606</b>	<b>12,88</b>
13/32"	3/4" 16h UNF	<b>FS45 0808</b>	<b>14,42</b>
1/2"	7/8" 14h UNF	<b>FS45 1010</b>	<b>15,34</b>

## Codo 90° hembra giratoria SAE

*90° Swivel female SAE*

*Femelle tournante 90° SAE*



*Femmina a 90° SAE*

DN	THREAD ROSCA	Part n° Referencia	€
5/16"	5/8" 18h UNF	<b>FS90 0606</b>	<b>13,04</b>
13/32"	3/4" 16h UNF	<b>FS90 0808</b>	<b>14,42</b>
1/2"	7/8" 14h UNF	<b>FS90 1010</b>	<b>15,49</b>

# Racores aire acondicionado

Air conditioning fittings  
Raccords climatisation  
Raccordi aria condizionata

## Hembra recta con junta Rotalock y válvula

*Straight female with Rotalock joint and valve*

Femelle droite Rotalock avec joint et vanne pour R12

Femmina diritta con guarnizione Rotalock e valvola



DN	THREAD ROSCA	Part n° Referencia	€
13/32"	1" 14h UNS	<b>FXRV 1108</b>	<b>20,25</b>
1/2"	1" 14h UNS	<b>FXRV 1110</b>	<b>22,42</b>

## Hembra especial 90° con junta Rotalock y válvula

*90° Special female with Rotalock joint and valve*

Femelle spéciale 90° Rotalock avec joint et vanne pour R12

Femmina a 90° speciale con guarnizione Rotalock e valvola



DN	THREAD ROSCA	Part n° Referencia	€
13/32"	1" 14h UNS	<b>FXAV90 1108</b>	<b>29,14</b>
1/2"	1" 14h UNS	<b>FXAV90 1110</b>	<b>29,45</b>

## Junta tórica para racores Freón 134

*Joints for air conditioning 134 fittings*

Joint torique spécial pour Freon 134

O'ring per raccordi per Freon 134



DN	Part n° Referencia	€
5/16"	<b>7.65X1.78 FREON</b>	<b>0,72</b>
13/32"	<b>10.82X1.78 FREON</b>	<b>0,84</b>
5/8"	<b>14X1.78 FREON</b>	<b>1,05</b>
5/8"	<b>18.77X1.78 FREON</b>	<b>1,31</b>

## Racor de unión con válvula

*Union fitting with valve*

Raccord union avec vanne pour R14 splicer vanne pour R12

Raccordi de unione con valvola



DN	Part n° Referencia	€
5/16"	<b>URTV 0006</b>	<b>17,79</b>
13/32"	<b>URTV 0008</b>	<b>18,25</b>
1/2"	<b>URTV 0010</b>	<b>18,87</b>

## Hembra 90° con junta Rotalock y válvula

*90° Female with Rotalock joint and valve*

Femelle 90° Rotalock avec joint et vanne pour R12

Femmina a 90° con guarnizione Rotalock e valvola



DN	THREAD ROSCA	Part n° Referencia	€
13/32"	1" 14h UNS	<b>FX90V 1108</b>	<b>22,24</b>
1/2"	1" 14h UNS	<b>FX90V 1110</b>	<b>23,31</b>

## Racores recuperables cargadoras

*Reusable fittings for loaders*

Raccords climatisation récupérables pour chargeurs

Raccordi recuperabili per carico



DN	THREAD ROSCA	DESCRIPTION DESCRIPCIÓN	Part n° Referencia	€
3/16"	7/16"	90° Swivel female	<b>CRFC900703</b>	<b>14,70</b>
3/16"	7/16"	Ferrule	<b>CRFM003</b>	<b>4,46</b>
3/16"	7/16"	Swivel female	<b>CRFTL0703</b>	<b>6,04</b>

# ATENCIÓN



UNA CORRECTA LUBRICACIÓN GARANTIZA EL BUEN FUNCIONAMIENTO DE LAS ROSCAS

**NO LO OLVIDE**



**DO NOT FORGET IT**

A CORRECT LUBRICATING GUARANTEES YOU A CORRECT USE OF THE THREADS



# WARNING

# Tubo rígado

*Pipe connectors*  
*Connectique rigide*  
*Tubo rigido*

# TrAle®

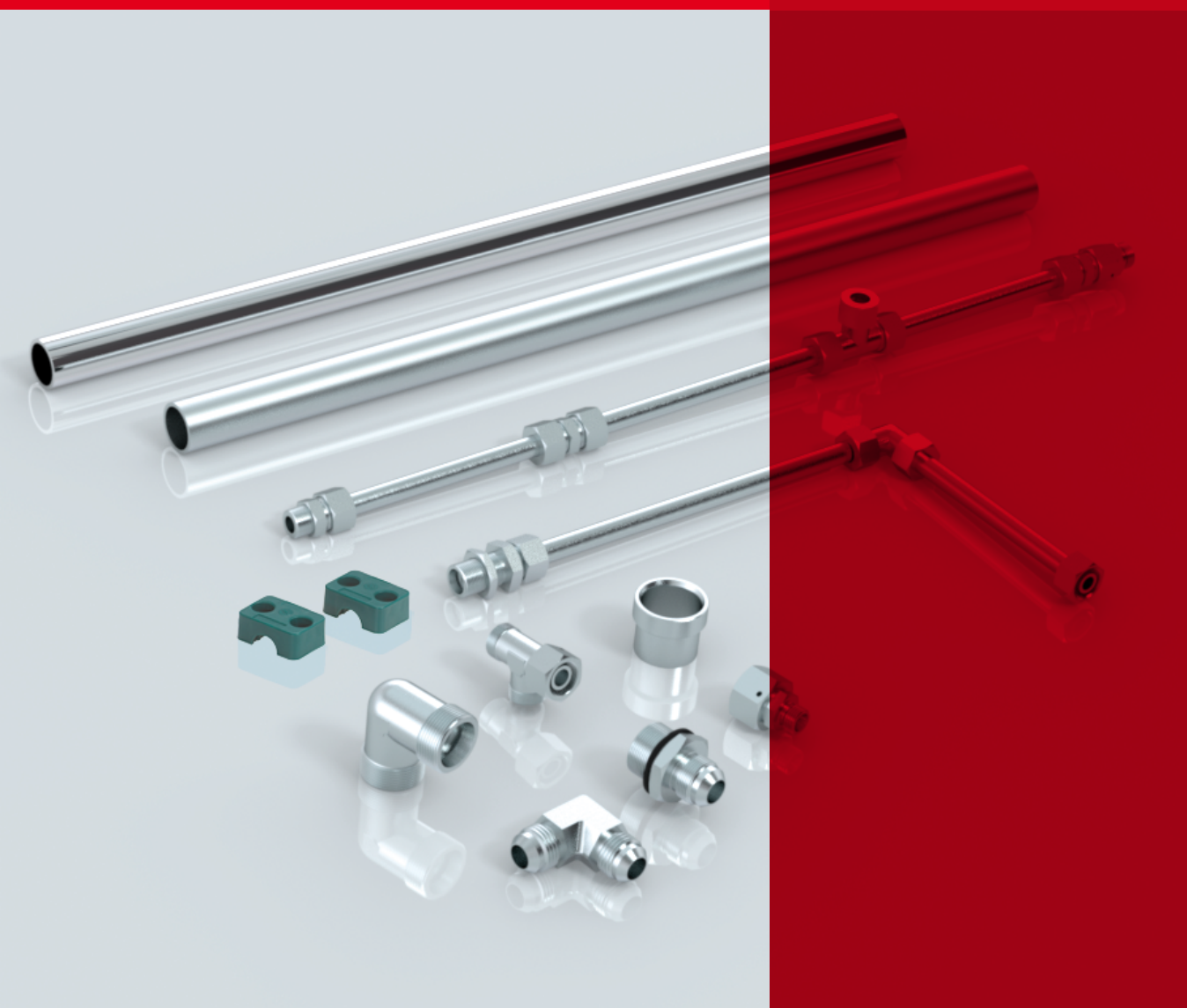

**Tubo rígido TrΔle**

*TrΔle Pipe*  
Tube rigide TrΔle  
*Tubo rigido TrΔle*

1

**Racores DIN 2353 / Racores JIC 37°**

*Pipe Fittings DIN 2353 / Flare fittings JIC 37°*  
Raccords DIN 2353 / Adapteurs JIC 37°  
*Raccordi DIN 2353 / Raccordi JIC 37°*

2

**Bridas SAE**

*SAE Flanges*  
Brides de fixation SAE  
*Flangia SAE*

3

**Abrazaderas TrΔle**

*TrΔle Clamps*  
Colliers TrΔle  
*Collari fissatubo TrΔle*

4

**Máquinas para procesar el tubo rígido**

*Machines for processing rigid pipes*  
Machines pour travailler le tube rigide  
*Macchine per il trattamento del tubo rigido*

5

## Tubo rígido TrΔle

*TrΔle Pipe*

Tube rigide TrΔle

*Tubo rigido TrΔle*

## Tubo rígido métrico TrΔle

*Pipe EN 10305-4 (Metric) TrΔle*

Tube rigide EN 10305-4 (Métrique) TrΔle

*Tubo rigido EN 10305-4 (metrico) TrΔle*

1

## Tubo rígido métrico TrΔle

Pipe EN 10305-4 (Metric) TrΔle

Tube rigide EN 10305-4 (Métrique) TrΔle

Tubo rígido EN 10305-4 (metrico) TrΔle

- EN 10305-4 / Pipe EN 10305-4 (Metric) / Tube rigide EN 10305-4 (Métrique) / Tubo rígido EN 10305-4 (metrico)



TH0



THZ



TH0\_3



THZ\_3

# Tubo rígido métrico TrΔle

Pipe EN 10305-4 (Metric) TrΔle

Tube rigide EN 10305-4 (Métrique) TrΔle

Tubo rígido EN 10305-4 (metrico) TrΔle

## Tubo rígido E235 (standard) - 6 mts

Pipe E235 (standard) - 6 mts

Tube rigide E235 (standard) - 6 mts

Tubo rígido E235 (standard) - 6 mts



Ø OUTER Ø EXT.	Ø INNER Ø INT.	WP (bar) PRESIÓN TRABAJO (bar)	KG/M	Part nº Referencia	€
6	4	365	0,123	<b>TH0060100</b>	<b>4,45</b>
8	6	259	0,173	<b>TH0080100</b>	<b>5,01</b>
8	5	423	0,240	<b>TH0080150</b>	<b>5,38</b>
10	7	321	0,314	<b>TH0100150</b>	<b>5,94</b>
12	9	259	0,388	<b>TH0120150</b>	<b>6,62</b>
14	10	303	0,592	<b>TH0140200</b>	<b>9,65</b>
15	12	201	0,499	<b>TH0150150</b>	<b>7,85</b>
16	12	259	0,690	<b>TH0160200</b>	<b>10,51</b>
18	14	226	0,789	<b>TH0180200</b>	<b>10,88</b>
20	14	321	1,258	<b>TH0200300</b>	<b>16,75</b>
22	18	181	0,986	<b>TH0220200</b>	<b>13,66</b>
25	19	247	1,628	<b>TH0250300</b>	<b>20,65</b>
28	24	139	1,282	<b>TH0280200</b>	<b>18,05</b>
30	24	201	1,997	<b>TH0300300</b>	<b>24,61</b>
35	29	169	2,367	<b>TH0350300</b>	<b>29,74</b>
42	36	139	2,885	<b>TH0420300</b>	<b>36,23</b>

## Tubo rígido E235 (standard) - 3 mts

Pipe E235 (standard) - 3 mts

Tube rigide E235 (standard) - 3 mts

Tubo rígido E235 (standard) - 3 mts



Ø OUTER Ø EXT.	Ø INNER Ø INT.	WP (bar) PRESIÓN TRABAJO (bar)	KG/M	Part nº Referencia	€
6	4	365	0,123	<b>TH0060100-3</b>	<b>4,67</b>
8	6	259	0,172	<b>TH0080100-3</b>	<b>5,26</b>
8	5	423	0,24	<b>TH0080150-3</b>	<b>5,65</b>
10	7	321	0,314	<b>TH0100150-3</b>	<b>6,23</b>
12	9	259	0,388	<b>TH0120150-3</b>	<b>6,95</b>
14	10	303	0,591	<b>TH0140200-3</b>	<b>10,13</b>
15	12	201	0,499	<b>TH0150150-3</b>	<b>8,24</b>
16	12	259	0,69	<b>TH0160200-3</b>	<b>11,04</b>
18	14	226	0,789	<b>TH0180200-3</b>	<b>11,43</b>
20	14	321	1,257	<b>TH0200300-3</b>	<b>17,59</b>
22	18	181	0,986	<b>TH0220200-3</b>	<b>14,35</b>
25	19	247	1,627	<b>TH0250300-3</b>	<b>21,68</b>
28	24	139	1,282	<b>TH0280200-3</b>	<b>18,96</b>
30	24	201	1,997	<b>TH0300300-3</b>	<b>25,84</b>
35	29	169	2,367	<b>TH0350300-3</b>	<b>31,22</b>
42	36	139	2,885	<b>TH0420300-3</b>	<b>38,04</b>

## Tubo rígido E235 (Cromo III) - 6 mts

Pipe E235 (Chrome III) - 6 mts

Tube rigide E235 (Chrome III) - 6 mts

Tubo rígido E235 (Cromo III) - 6 mts



Ø OUTER Ø EXT.	Ø INNER Ø INT.	WP (bar) PRESIÓN TRABAJO (bar)	KG/M	Part nº Referencia	€
6	4	365	0,123	<b>THZ060100</b>	<b>5,13</b>
8	6	259	0,173	<b>THZ080100</b>	<b>5,94</b>
8	5	423	0,240	<b>THZ080150</b>	<b>6,18</b>
10	7	321	0,314	<b>THZ100150</b>	<b>7,23</b>
12	9	259	0,388	<b>THZ120150</b>	<b>7,91</b>
12	8	365	0,500	<b>THZ120200</b>	<b>9,95</b>
14	10	303	0,592	<b>THZ140200</b>	<b>11,13</b>
15	12	201	0,499	<b>THZ150150</b>	<b>9,58</b>
15	11	279	0,641	<b>THZ150200</b>	<b>12,86</b>
16	12	259	0,690	<b>THZ160200</b>	<b>12,24</b>
18	15	164	0,610	<b>THZ180150</b>	<b>11,19</b>
18	14	226	0,789	<b>THZ180200</b>	<b>12,92</b>
20	14	321	1,258	<b>THZ200300</b>	<b>18,92</b>
22	18	189	0,986	<b>THZ220200</b>	<b>16,07</b>
25	19	247	1,628	<b>THZ250300</b>	<b>23,93</b>
28	24	139	1,282	<b>THZ280200</b>	<b>21,70</b>
30	22	279	2,565	<b>THZ300400</b>	<b>36,60</b>
35	29	169	2,367	<b>THZ350300</b>	<b>34,44</b>
38	30	213	3,354	<b>THZ380400</b>	<b>47,79</b>
42	36	139	2,885	<b>THZ420300</b>	<b>42,29</b>

## Tubo rígido E235 (Cromo III) - 3 mts

Pipe E235 (Chrome III) - 3 mts

Tube rigide E235 (Chrome III) - 3 mts

Tubo rígido E235 (Cromo III) - 3 mts



Ø OUTER Ø EXT.	Ø INNER Ø INT.	WP (bar) PRESIÓN TRABAJO (bar)	KG/M	Part nº Referencia	€
6	4	365	0,123	<b>THZ060100-3</b>	<b>5,39</b>
8	6	259	0,172	<b>THZ080100-3</b>	<b>6,23</b>
8	5	423	0,240	<b>THZ080150-3</b>	<b>6,49</b>
10	7	321	0,314	<b>THZ100150-3</b>	<b>7,60</b>
12	9	259	0,388	<b>THZ120150-3</b>	<b>8,31</b>
12	8	365	0,500	<b>THZ120200-3</b>	<b>10,45</b>
14	10	303	0,591	<b>THZ140200-3</b>	<b>11,68</b>
15	12	201	0,499	<b>THZ150150-3</b>	<b>10,06</b>
15	11	279	0,641	<b>THZ150200-3</b>	<b>13,50</b>
16	12	259	0,690	<b>THZ160200-3</b>	<b>12,85</b>
18	15	164	0,610	<b>THZ180150-3</b>	<b>11,75</b>
18	14	226	0,789	<b>THZ180200-3</b>	<b>13,57</b>
20	14	321	1,257	<b>THZ200300-3</b>	<b>19,87</b>
22	18	189	0,986	<b>THZ220200-3</b>	<b>16,88</b>
25	19	247	1,627	<b>THZ250300-3</b>	<b>25,12</b>
28	24	139	1,282	<b>THZ280200-3</b>	<b>22,79</b>
30	22	279	2,564	<b>THZ300400-3</b>	<b>38,43</b>
35	29	169	2,367	<b>THZ350300-3</b>	<b>36,16</b>
38	30	213	3,354	<b>THZ380400-3</b>	<b>50,18</b>
42	36	139	2,885	<b>THZ420300-3</b>	<b>44,40</b>

## Racores DIN 2353 / Racores JIC 37°

*Pipe Fittings DIN 2353 / Flare fittings JIC 37°*

*Raccords DIN 2353 / Adapteurs JIC 37°*

*Raccordi DIN 2353 / Raccordi JIC 37°*

### **Racores DIN 2353**

*DIN 2353 Pipe fittings*  
*Raccords à bague DIN 2353*  
*Raccordi ad anello DIN 2353*

214

### **Racores JIC 37°**

*JIC 37° fittings*  
*Raccords JIC 37°*  
*Raccordi JIC 37°*

233

2

# Racores DIN 2353

*DIN 2353 Pipe fittings*

*Raccords à bague DIN 2353*

*Raccordi ad anello DIN 2353*

- Tuercas y anillos / Nuts and cutting rings / Écrou et bagues / Dadi e anelli | 214

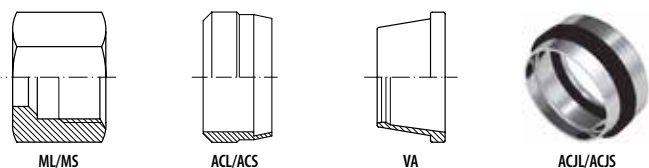

- Uniones tubo-tubo / Straight couplings / Unions doubles / Raccordi intermedi | 216

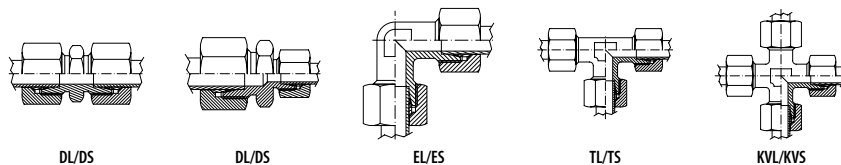

- Uniones rectas tubo-rosca / Straight male stud couplings / Unions simples mâle / Raccordi di estremità diritti | 218

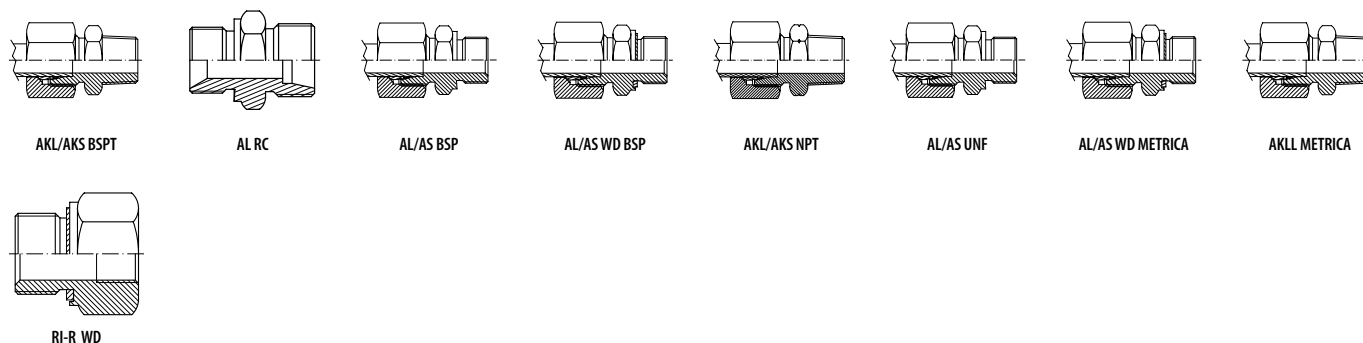

- Codos tubo-rosca / Male stud elbows / Coudes mâle gaz / Raccordi di estremità a 90° | 222

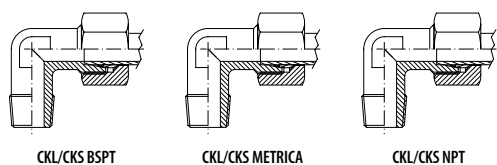

- Uniones Métricas / Metric unions / Unions Métriques / Raccordi di riduzione (Metrici) | 223

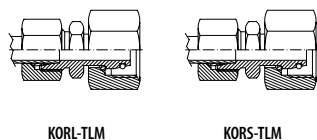

- Racores regulables / Adjustable stud couplings / Raccords réglables / Raccordi orientabili | 223

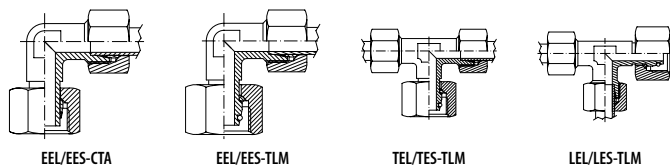

- Tubo roscado (hembra giratoria) / Adjustable straight stud / Tube fileté / Raccordi di estremità per combinazioni | 225

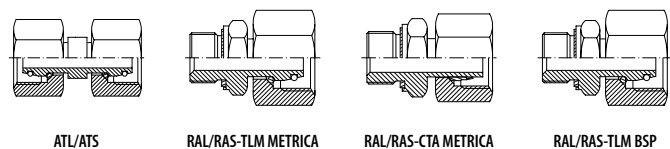

# Racores DIN 2353

*DIN 2353 Pipe fittings*  
*Raccords à bague DIN 2353*  
*Raccordi ad anello DIN 2353*

- Soldables /Welding couplings /Raccords à souder /Raccordi a saldare | 226

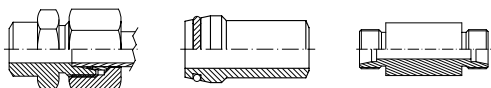

ASL/ASS

ORIS

ESVL/ESVS

- Pasatabiques /Bulkhead /Passe cloison /Raccordi di attraversamento | 227

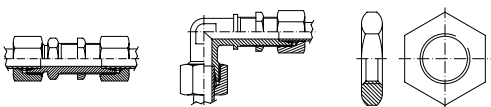

SVL/SVS

USVL/USVS

TP L/S

- Racor recto hembra /Straight female coupling /Raccord droit femelle /Raccordi diritti con estremità femmina | 228

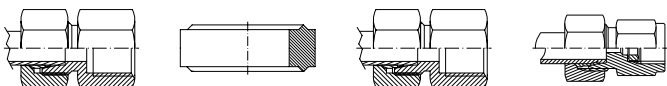

GAIL/GAIS BSP

AM

GAIL/GAIS METRICA

MAVL/MAVS BSP

- Orientables /Banjos /Banjos /Raccordi orientabili a occhio | 229

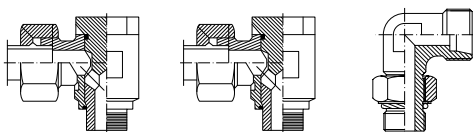

WSVL/WSVS BSP

WSVL/WSVS METRICA

STA WEE

- Taponos /Plugs /Bouchons /Tappi | 230

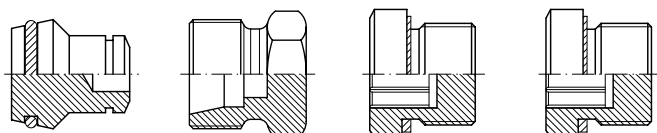

BUTZEN L/S

STA TML/TMS

STOPFEN BSP

STOPFEN METRICA

- Válvulas antirretorno /Non-return valves /Clapet antiretour pour tube /Valvole di ritegno | 231



RHDH/RHDS

RHVL/RHVS

RHZL/RHZS

# Racores JIC 37°

JIC 37° fittings

Raccordi JIC 37°

Raccordi JIC 37°

- Tuerkas y férulas JIC 37° / Nuts and Sleeves / Écrous et Férules JIC 37° / Dadi e Bussole JIC 37°

| 233

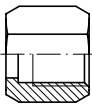

S110

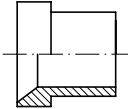

S120

- Tapones JIC 37° / JIC 37° Plugs / Bouchons JIC 37° / Tappi JIC 37°

| 233

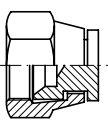

S130

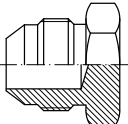

S140

- Uniones rectas JIC 37° / JIC 37° Straight union / Unions droites JIC 37° / Adattatori diritti JIC 37°

| 233

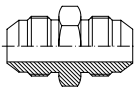

S260

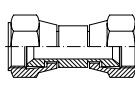

S730

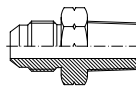

S200

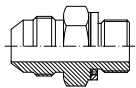

S230

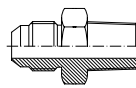

S210

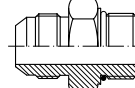

S220

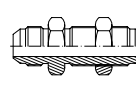

S250

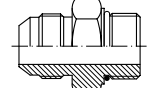

S240

- Uniones macho-hembra JIC 37° / JIC 37° Male-female unions / Unions mâle JIC 37° x femelle JIC 37° / Adattatori maschio-femmina JIC 37°

| 235

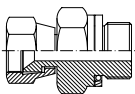

S180

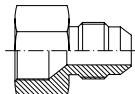

S290

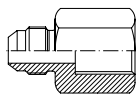

S280

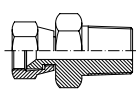

S150



S215

- Codos JIC 37° / JIC 37° Elbows / Coudes JIC 37° / Adattatori a 45° e 90° JIC 37°

| 236

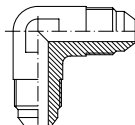

S500

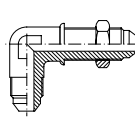

S650

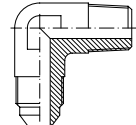

S550

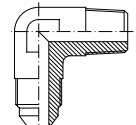

S525

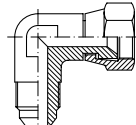

S675

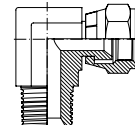

S595

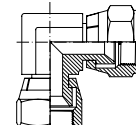

S665

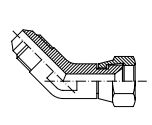

S690

- Codos Orientables JIC 37° / JIC 37° Elbow / Adapteur orientable coude JIC 37° / Raccordo orientabile

| 238

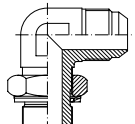

S600

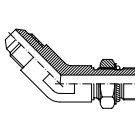

S615

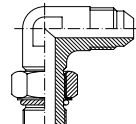

S575

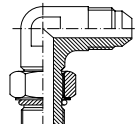

S625

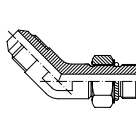

S775

- Tes JIC 37° / JIC 37° Tees / Tés JIC 37° / Adattatori a T JIC 37°

| 239

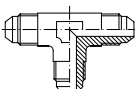

S505

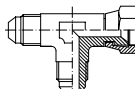

S680

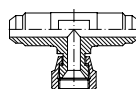

S685

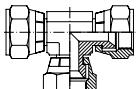

S670

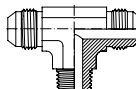

S681

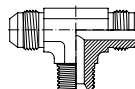

S695

- Tes orientable JIC 37° / JIC 37° Adjustable Tees / Tés orientables JIC 37° / Adattatori a T orientabili

| 240

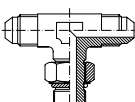

S610

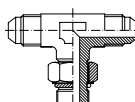

S585

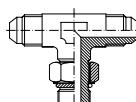

S635

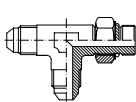

S605

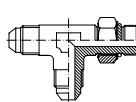

S580

# Racores DIN 2353

DIN 2353 Pipe fittings  
Raccords à bague DIN 2353  
Raccordi DIN 2353

Tr/Ale Pipe

Pipe Fittings DIN 2353  
/ Flare fittings JIC 37°

SAE Flanges

Tr/Ale Clamps

Machines for  
processing rigid pipes

## Instrucciones de montaje del racor DIN 2353 sobre el tubo rígido (se recomienda el uso de herramientas de premontaje)

Assembly of the pipe fittings DIN 2353 in the rigid pipe (It is recommended to use pre-assembly tools)

Mode d'emploi de montage du raccord DIN 2353 sur le tube rigide (l'utilisation des outils de pré-montage est conseillée)

Assemblaggio del raccordo ad anello DIN 2353 nel tubo rigido (è si consiglia l'uso degli utensili di premontaggio)

### A. Preparación del tubo

Preparation of the tube

Préparation du tube

Preparazione del tubo

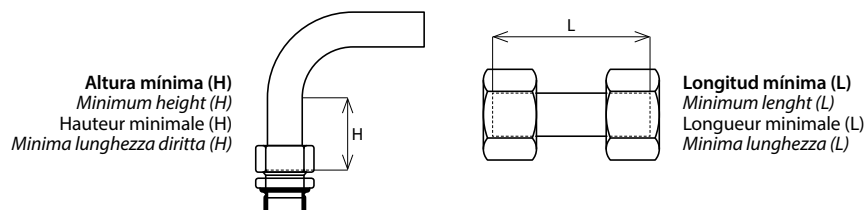

Altura mínima (H)  
Minimum height (H)  
Hauteur minimale (H)  
Minima lunghezza diritta (H)

Longitud mínima (L)  
Minimum length (L)  
Longueur minimale (L)  
Minima lunghezza (L)

	Series / Series / Série / Serie		
	LL	L	S
Ø exterior Ø outer Ø extérieur Ø esterno	4-5-6-8	6-8-10-12-15-18-22-28-35-42	6-8-10-12-14-16-20-25-30-38
H mínimo H minimum H minimum H minimo	24-25-25-26	31-31-33-33-36-38-42-42-48-48	35-35-37-37-43-43-50-54-58-65
L mínimo L minimum L minimum L minimo	30-32-32-33	39-39-42-42-45-48-53-53-60-60	44-44-47-47-54-54-63-68-73-82

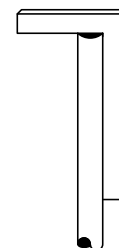

Cortar el tubo a escuadra y eliminar rebabas.

Rectangularly saw off the pipe and slightly debug the tube ends inside and outside.

Couper le tube à angle droit sans bavure. Tagliare il tubo ad angolo retto ed eliminare i residui metallici.

### B. Lubricar adecuadamente

Lubricate suitably

Lubrifier convenablement

Lubrificare convenientemente

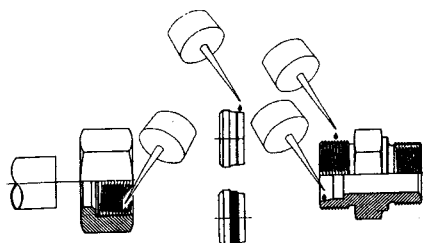

### C. Montaje

Assembly

Montage

Montaggio

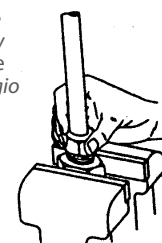

### D. Apriete

Blocking

Blockage

Bloccaggio

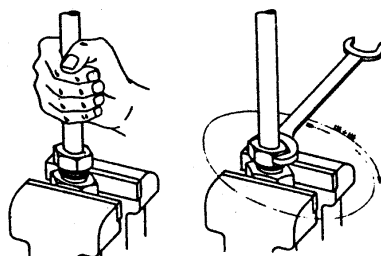

### E. Control

Control

Control

Controllo

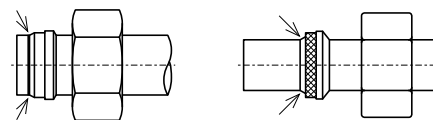

### F. Montaje final

Final assembly

Montage final

Montaggio finale

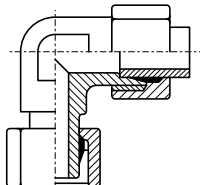

### G. Montajes posteriores

Later assemblies

Montages posterieurs

Montaggio successivo

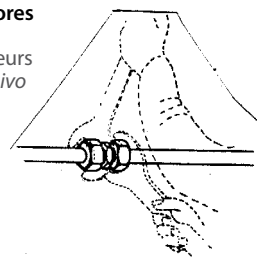

Nota sobre piezas premontadas (CTA): El montaje final se realizará apretando la tuerca al menos ½ vuelta más desde el punto a partir del cual se empieza a hacer más fuerza.

For preassembled fittings (CTA), the final assembly is made tightening the nut at least ½ turn beyond the point of a noticeable increase in force.

Pour les pièces pré-assemblées (CTA), le montage final doit être fait en tournant au moins un ½ tour à partir du point où une résistance plus importante est appréciée.

Per tutti i raccordi premontati (CTA), il premontaggio avviene con apposite attrezzature. Il montaggio finale si realizza serrando almeno ½ giro oltre il punto in cui si inizia ad avvertire chiaramente l'aumento della resistenza.

# Racores DIN 2353

DIN 2353 Pipe fittings

Raccords à bague DIN 2353

Raccordi ad anello DIN 2353

## Tuerca Métrica DIN 3870

Nuts DIN 3870

Écrou Métrique DIN 3870

Dadi Metrici DIN 3870

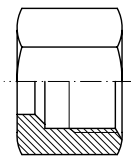

PIPE TUBO	SERIE	THREAD ROSCA	Part nº Referencia	€
4	LL	M8x1	<b>MLL 4 M 8X1</b>	<b>0,35</b>
6	LL	M10x1	<b>MLL 6 M 10X1</b>	<b>0,35</b>
8	LL	M12x1	<b>MLL 8 M 12X1</b>	<b>0,41</b>
6	L	M12x1,5	<b>ML 6 M 12X1.5</b>	<b>0,35</b>
8	L	M14x1,5	<b>ML 8 M 14X1.5</b>	<b>0,32</b>
10	L	M16x1,5	<b>ML 10 M 16X1.5</b>	<b>0,38</b>
12	L	M18x1,5	<b>ML 12 M 18X1.5</b>	<b>0,47</b>
15	L	M22x1,5	<b>ML 15 M 22X1.5</b>	<b>0,74</b>
18	L	M26x1,5	<b>ML 18 M 26X1.5</b>	<b>1,15</b>
22	L	M30x2	<b>ML 22 M 30X2</b>	<b>1,62</b>
28	L	M36x2	<b>ML 28 M 36X2</b>	<b>2,67</b>
35	L	M45x2	<b>ML 35 M 45X2</b>	<b>4,63</b>
42	L	M52x2	<b>ML 42 M 52X2</b>	<b>6,36</b>
6	S	M14x1,5	<b>MS 6 M 14X1.5</b>	<b>0,39</b>
8	S	M16x1,5	<b>MS 8 M 16X1.5</b>	<b>0,43</b>
10	S	M18x1,5	<b>MS 10 M 18X1.5</b>	<b>0,55</b>
12	S	M20x1,5	<b>MS 12 M 20X1.5</b>	<b>0,59</b>
14	S	M22x1,5	<b>MS 14 M 22X1.5</b>	<b>1,12</b>
16	S	M24x1,5	<b>MS 16 M 24X1.5</b>	<b>1,16</b>
20	S	M30x2	<b>MS 20 M 30X2</b>	<b>1,82</b>
25	S	M36x2	<b>MS 25 M 36X2</b>	<b>3,78</b>
30	S	M42x2	<b>MS 30 M 42X2</b>	<b>5,78</b>
38	S	M52x2	<b>MS 38 M 52X2</b>	<b>7,61</b>

## Anillos de corte DIN 3861

Cutting rings DIN 3861

Bague Métrique DIN 3861

Anelli DIN 3861

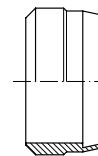

PIPE TUBO	SERIE	Part nº Referencia	€
4	LL	<b>ACLL 4</b>	<b>0,23</b>
6	LL	<b>ACLL 6</b>	<b>0,24</b>
8	LL	<b>ACLL 8</b>	<b>0,29</b>
6	L/S	<b>ACL 6</b>	<b>0,31</b>
8	L/S	<b>ACL 8</b>	<b>0,32</b>
10	L/S	<b>ACL 10</b>	<b>0,44</b>
12	L/S	<b>ACL 12</b>	<b>0,46</b>
15	L	<b>ACL 15</b>	<b>0,49</b>
18	L	<b>ACL 18</b>	<b>0,70</b>
22	L	<b>ACL 22</b>	<b>0,79</b>
28	L	<b>ACL 28</b>	<b>1,01</b>
35	L	<b>ACL 35</b>	<b>1,08</b>
42	L	<b>ACL 42</b>	<b>2,03</b>
14	S	<b>ACS 14</b>	<b>0,60</b>
16	S	<b>ACS 16</b>	<b>0,70</b>
20	S	<b>ACS 20</b>	<b>0,79</b>
25	S	<b>ACS 25</b>	<b>1,01</b>
30	S	<b>ACS 30</b>	<b>1,23</b>
38	S	<b>ACS 38</b>	<b>1,59</b>

## Anillo FKM antifuga

FKM seal non-leak

Joint FKM anti-fouet

Anello FKM anti-trafilamento

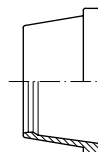

PIPE TUBO	SERIE	Part nº Referencia	€
6	L/S	<b>VA006L</b>	<b>1,33</b>
8	L/S	<b>VA008L</b>	<b>1,41</b>
10	L/S	<b>VA010L</b>	<b>1,46</b>
12	L/S	<b>VA012L</b>	<b>1,58</b>
15	L	<b>VA015L</b>	<b>2,07</b>
18	L	<b>VA018L</b>	<b>2,13</b>
22	L	<b>VA022L</b>	<b>2,39</b>
28	L	<b>VA028L</b>	<b>3,29</b>
35	L	<b>VA035L</b>	<b>5,20</b>
42	L	<b>VA042L</b>	<b>6,25</b>
14	S	<b>VA014S</b>	<b>1,72</b>
16	S	<b>VA016S</b>	<b>2,09</b>
20	S	<b>VA020S</b>	<b>2,30</b>
25	S	<b>VA025S</b>	<b>3,12</b>
30	S	<b>VA030S</b>	<b>4,77</b>
38	S	<b>VA038S</b>	<b>6,15</b>

Hasta fin de existencias / Until end of stock / Jusqu'à la fin du stock / Fino ad esaurimento scorta

# Racores DIN 2353

DIN 2353 Pipe fittings  
Raccords à bague DIN 2353  
Raccordi ad anello DIN 2353

## Anillos de corte con junta plana + tórica

Cutting ring with captive seal & o´ring

Bague Métrique avec écrou + o´ring

Anelli tagliante con guarnizione piana + O-ring



PIPE TUBO	SERIE	Part nº Referencia	€
6	L	ACJL 6	1,06
8	L	ACJL 8	1,16
10	L	ACJL 10	1,23
12	L	ACJL 12	1,37
15	L	ACJL 15	1,64
18	L	ACJL 18	2,11
22	L	ACJL 22	2,55
28	L	ACJL 28	3,46
35	L	ACJL 35	5,66
42	L	ACJL 42	6,52
6	S	ACJS 6	1,06
8	S	ACJS 8	1,26
10	S	ACJS 10	1,26
12	S	ACJS 12	1,49
14	S	ACJS 14	1,59
16	S	ACJS 16	1,93
20	S	ACJS 20	2,68
25	S	ACJS 25	3,55
30	S	ACJS 30	4,81
38	S	ACJS 38	6,87

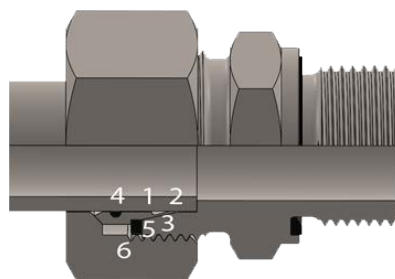

- Asegura una completa estanqueidad con el anillo de corte con junta
- To ensure the right tightening with our cutting ring with joint

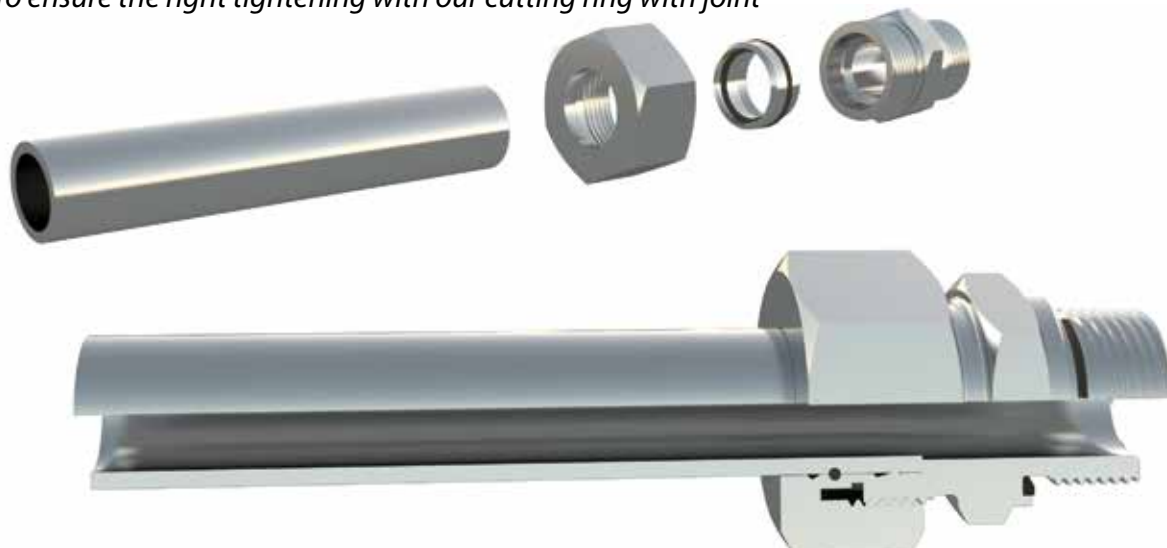

Consulta en nuestra ficha técnica datos | Check our technical sheet for data

# Racores DIN 2353

DIN 2353 Pipe fittings  
Raccords à bague DIN 2353  
Raccordi ad anello DIN 2353

## Unión recta tubo-tubo

*Straight coupling (pipe-pipe)*

*Union droite (tuyau-tuyau)*

*Raccordo intermedio diritto (tubo-tubo)*

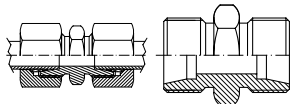

PIPE TUBO	SERIE	Part nº Referencia	€	Part Nº STA Referencia STA	€
4	LL	<b>DLL 4</b>	<b>2,76</b>	<b>STA DLL 4</b>	<b>1,08</b>
6	LL	<b>DLL 6</b>	<b>2,75</b>	<b>STA DLL 6</b>	<b>1,05</b>
8	LL	<b>DLL 8</b>	<b>2,97</b>	<b>STA DLL 8</b>	<b>1,05</b>
6	L	<b>DL 6</b>	<b>2,67</b>	<b>STA DL 6</b>	<b>0,83</b>
8	L	<b>DL 8</b>	<b>2,75</b>	<b>STA DL 8</b>	<b>0,95</b>
10	L	<b>DL 10</b>	<b>3,18</b>	<b>STA DL 10</b>	<b>1,02</b>
12	L	<b>DL 12</b>	<b>3,41</b>	<b>STA DL 12</b>	<b>1,03</b>
15	L	<b>DL 15</b>	<b>4,83</b>	<b>STA DL 15</b>	<b>1,69</b>
18	L	<b>DL 18</b>	<b>6,35</b>	<b>STA DL 18</b>	<b>1,97</b>
22	L	<b>DL 22</b>	<b>8,96</b>	<b>STA DL 22</b>	<b>3,10</b>
28	L	<b>DL 28</b>	<b>13,62</b>	<b>STA DL 28</b>	<b>5,22</b>
35	L	<b>DL 35</b>	<b>20,78</b>	<b>STA DL 35</b>	<b>7,80</b>
42	L	<b>DL 42</b>	<b>31,32</b>	<b>STA DL 42</b>	<b>12,98</b>
6	S	<b>DS 6</b>	<b>2,93</b>	<b>STA DS 6</b>	<b>1,01</b>
8	S	<b>DS 8</b>	<b>3,36</b>	<b>STA DS 8</b>	<b>1,34</b>
10	S	<b>DS 10</b>	<b>4,13</b>	<b>STA DS 10</b>	<b>1,63</b>
12	S	<b>DS 12</b>	<b>4,40</b>	<b>STA DS 12</b>	<b>1,78</b>
14	S	<b>DS 14</b>	<b>6,28</b>	<b>STA DS 14</b>	<b>2,16</b>
16	S	<b>DS 16</b>	<b>6,63</b>	<b>STA DS 16</b>	<b>2,23</b>
20	S	<b>DS 20</b>	<b>10,21</b>	<b>STA DS 20</b>	<b>3,95</b>
25	S	<b>DS 25</b>	<b>17,10</b>	<b>STA DS 25</b>	<b>6,48</b>
30	S	<b>DS 30</b>	<b>24,98</b>	<b>STA DS 30</b>	<b>9,40</b>
38	S	<b>DS 38</b>	<b>35,20</b>	<b>STA DS 38</b>	<b>15,24</b>

## Unión recta en reducción tubo-tubo

*Straight reducing coupling (pipe-pipe)*

*Union double en réduction (tuyau-tuyau)*

*Raccordo intermedio di riduzione (tubo-tubo)*

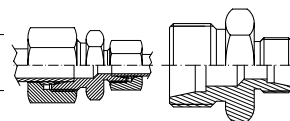

PIPE TUBO	SERIE	Part nº Referencia	€	Part Nº STA Referencia STA	€	
8	6	L	<b>DL 8-6</b>	<b>3,01</b>	<b>STA DL 8-6</b>	<b>1,19</b>
10	6	L	<b>DL 10-6</b>	<b>3,24</b>	<b>STA DL 10-6</b>	<b>1,24</b>
10	8	L	<b>DL 10-8</b>	<b>3,32</b>	<b>STA DL 10-8</b>	<b>1,34</b>
12	8	L	<b>DL 12-8</b>	<b>3,43</b>	<b>STA DL 12-8</b>	<b>1,34</b>
12	10	L	<b>DL 12-10</b>	<b>3,64</b>	<b>STA DL 12-10</b>	<b>1,37</b>
15	10	L	<b>DL 15-10</b>	<b>4,72</b>	<b>STA DL 15-10</b>	<b>2,07</b>
15	12	L	<b>DL 15-12</b>	<b>4,81</b>	<b>STA DL 15-12</b>	<b>2,05</b>
18	12	L	<b>DL 18-12</b>	<b>5,79</b>	<b>STA DL 18-12</b>	<b>2,41</b>
18	15	L	<b>DL 18-15</b>	<b>6,05</b>	<b>STA DL 18-15</b>	<b>2,29</b>
22	15	L	<b>DL 22-15</b>	<b>8,52</b>	<b>STA DL 22-15</b>	<b>4,02</b>
22	18	L	<b>DL 22-18</b>	<b>8,67</b>	<b>STA DL 22-18</b>	<b>3,55</b>
28	22	L	<b>DL 28-22</b>	<b>12,87</b>	<b>STA DL 28-22</b>	<b>5,74</b>
35	22	L	<b>DL 35-22</b>	<b>31,43</b>	<b>STA DL 35-22</b>	<b>22,01</b>
35	28	L	<b>DL 35-28</b>	<b>32,70</b>	<b>STA DL 35-28</b>	<b>22,01</b>
8	6	S	<b>DS 8-6</b>	<b>3,50</b>	<b>STA DS 8-6</b>	<b>1,53</b>
10	6	S	<b>DS 10-6</b>	<b>3,69</b>	<b>STA DS 10-6</b>	<b>1,48</b>
10	8	S	<b>DS 10-8</b>	<b>3,86</b>	<b>STA DS 10-8</b>	<b>1,60</b>
12	6	S	<b>DS 12-6</b>	<b>4,44</b>	<b>STA DS 12-6</b>	<b>2,17</b>
12	8	S	<b>DS 12-8</b>	<b>4,91</b>	<b>STA DS 12-8</b>	<b>2,59</b>
12	10	S	<b>DS 12-10</b>	<b>5,15</b>	<b>STA DS 12-10</b>	<b>2,59</b>
14	10	S	<b>DS 14-10</b>	<b>5,70</b>	<b>STA DS 14-10</b>	<b>2,39</b>
14	12	S	<b>DS 14-12</b>	<b>5,68</b>	<b>STA DS 14-12</b>	<b>2,31</b>
16	12	S	<b>DS 16-12</b>	<b>6,16</b>	<b>STA DS 16-12</b>	<b>2,65</b>
16	14	S	<b>DS 16-14</b>	<b>7,02</b>	<b>STA DS 16-14</b>	<b>2,76</b>
20	12	S	<b>DS 20-12</b>	<b>9,05</b>	<b>STA DS 20-12</b>	<b>4,61</b>
20	16	S	<b>DS 20-16</b>	<b>9,69</b>	<b>STA DS 20-16</b>	<b>4,36</b>
25	16	S	<b>DS 25-16</b>	<b>14,33</b>	<b>STA DS 25-16</b>	<b>6,82</b>
25	20	S	<b>DS 25-20</b>	<b>16,47</b>	<b>STA DS 25-20</b>	<b>8,03</b>
30	20	S	<b>DS 30-20</b>	<b>34,96</b>	<b>STA DS 30-20</b>	<b>24,04</b>
30	25	S	<b>DS 30-25</b>	<b>37,53</b>	<b>STA DS 30-25</b>	<b>24,43</b>
38	30	S	<b>DS 38-30</b>	<b>52,22</b>	<b>STA DS 38-30</b>	<b>34,45</b>

# Racores DIN 2353

DIN 2353 Pipe fittings  
Raccords à bague DIN 2353  
Raccordi ad anello DIN 2353

## Unión en codo tubo-tubo

Equal elbow coupling (pipe-pipe)

Union en coude égal (tuyau-tuyau)

Raccordo intermedio a 90° (tubo-tubo)

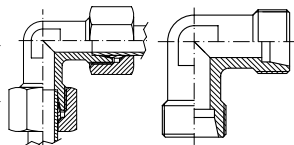

PIPE TUBO	SERIE	Part nº Referencia	€	Part Nº STA Referencia STA	€
4	LL	ELL 4	3,90	STA ELL 4	2,22
6	LL	ELL 6	3,92	STA ELL 6	2,22
8	LL	ELL 8	4,48	STA ELL 8	2,56
6	L	EL 6	4,81	STA EL 6	2,97
8	L	EL 8	4,70	STA EL 8	2,90
10	L	EL 10	5,06	STA EL 10	2,90
12	L	EL 12	5,62	STA EL 12	3,24
15	L	EL 15	8,00	STA EL 15	4,86
18	L	EL 18	10,65	STA EL 18	6,27
22	L	EL 22	13,58	STA EL 22	7,72
28	L	EL 28	22,46	STA EL 28	14,06
35	L	EL 35	37,97	STA EL 35	24,99
42	L	EL 42	48,81	STA EL 42	30,47
6	S	ES 6	5,38	STA ES 6	3,46
8	S	ES 8	5,62	STA ES 8	3,60
10	S	ES 10	7,10	STA ES 10	4,60
12	S	ES 12	6,56	STA ES 12	3,94
14	S	ES 14	9,91	STA ES 14	5,79
16	S	ES 16	10,13	STA ES 16	5,73
20	S	ES 20	13,98	STA ES 20	7,72
25	S	ES 25	21,63	STA ES 25	11,01
30	S	ES 30	42,33	STA ES 30	26,75
38	S	ES 38	48,41	STA ES 38	28,45

## Unión en te tubo-tubo

Equal Tee union (pipe-pipe-pipe)

Union en Té égal (tuyau-tuyau)

Raccordo intermedio a T (tubo-tubo)

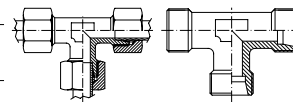

PIPE TUBO	SERIE	Part nº Referencia	€	Part Nº STA Referencia STA	€
4	LL	TLL 4	5,88	STA TLL 4	3,36
6	LL	TLL 6	5,30	STA TLL 6	2,75
8	LL	TLL 8	6,20	STA TLL 8	3,32
6	L	TL 6	6,18	STA TL 6	3,42
8	L	TL 8	6,56	STA TL 8	3,86
10	L	TL 10	7,09	STA TL 10	3,85
12	L	TL 12	8,02	STA TL 12	4,45
15	L	TL 15	10,08	STA TL 15	5,37
18	L	TL 18	15,96	STA TL 18	9,39
22	L	TL 22	21,12	STA TL 22	12,33
28	L	TL 28	34,15	STA TL 28	21,55
35	L	TL 35	63,79	STA TL 35	44,32
42	L	TL 42	91,70	STA TL 42	64,19
6	S	TS 6	6,48	STA TS 6	3,60
8	S	TS 8	8,75	STA TS 8	5,72
10	S	TS 10	9,49	STA TS 10	5,74
12	S	TS 12	10,49	STA TS 12	6,56
14	S	TS 14	13,16	STA TS 14	6,98
16	S	TS 16	15,18	STA TS 16	8,58
20	S	TS 20	20,41	STA TS 20	11,02
25	S	TS 25	37,04	STA TS 25	21,11
30	S	TS 30	48,94	STA TS 30	25,57
38	S	TS 38	72,96	STA TS 38	43,02

## Unión en cruz tubo-tubo

Equal cross union (pipe-pipe-pipe-pipe)

Union en croix égale (tuyau-tuyau)

Raccordo intermedio a croce (tubo-tubo)

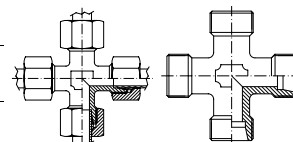

PIPE TUBO	SERIE	Part nº Referencia	€	Part Nº STA Referencia STA	€
6	L	KVL 6	*	STA KVL 6	8,41
8	L	KVL 8	*	STA KVL 8	10,45
10	L	KVL 10	*	STA KVL 10	10,45
12	L	KVL 12	*	STA KVL 12	10,62
15	L	KVL 15	*	STA KVL 15	15,00
18	L	KVL 18	*	STA KVL 18	21,34
22	L	KVL 22	*	STA KVL 22	44,90
28	L	KVL 28	*	STA KVL 28	52,51
35	L	KVL 35	*	STA KVL 35	88,55
42	L	KVL 42	*	STA KVL 42	141,59
6	S	KVS 6	*	STA KVS 6	15,59
8	S	KVS 8	*	STA KVS 8	16,38
10	S	KVS 10	*	STA KVS 10	16,74
12	S	KVS 12	*	STA KVS 12	17,83
14	S	KVS 14	*	STA KVS 14	27,27
16	S	KVS 16	*	STA KVS 16	27,37
20	S	KVS 20	*	STA KVS 20	46,58
25	S	KVS 25	*	STA KVS 25	52,95
30	S	KVS 30	*	STA KVS 30	103,25
38	S	KVS 38	*	STA KVS 38	141,59

# Racores DIN 2353

DIN 2353 Pipe fittings  
Raccords à bague DIN 2353  
Raccordi ad anello DIN 2353

## Racor recto rosca cónica BSPT

Straight male stud coupling BSPT tapered

Union simple mâle conique

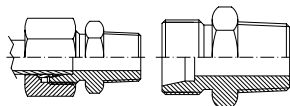

Raccordo di estremità diritto conico BSPT

PIPE TUBO	SERIE	THREAD ROSCA	Part nº Referencia	€	Part Nº STA Referencia STA	€
4	LL	1/8" BSPT	AKLL 4 R 1/8	1,69	STA AKLL 4 R 1/8	0,85
6	LL	1/8" BSPT	AKLL 6 R 1/8	1,70	STA AKLL 6 R 1/8	0,85
8	LL	1/8" BSPT	AKLL 8 R 1/8	1,83	STA AKLL 8 R 1/8	0,87
8	LL	1/4" BSPT	AKLL 8 R 1/4	1,93	STA AKLL 8 R 1/4	0,97
6	L	1/8" BSPT	AKL 6 R 1/8	1,81	STA AKL 6 R 1/8	0,89
6	L	1/4" BSPT	AKL 6 R 1/4	2,17	STA AKL 6 R 1/4	1,25
8	L	1/4" BSPT	AKL 8 R 1/4	2,12	STA AKL 8 R 1/4	1,22
10	L	1/4" BSPT	AKL 10 R 1/4	2,29	STA AKL 10 R 1/4	1,21
10	L	3/8" BSPT	AKL 10 R 3/8	2,57	STA AKL 10 R 3/8	1,49
12	L	1/4" BSPT	AKL 12 R 1/4	2,71	STA AKL 12 R 1/4	1,52
12	L	3/8" BSPT	AKL 12 R 3/8	2,69	STA AKL 12 R 3/8	1,50
12	L	1/2" BSPT	AKL 12 R 1/2	3,19	STA AKL 12 R 1/2	2,00
15	L	3/8" BSPT	AKL 15 R 3/8	3,15	STA AKL 15 R 3/8	1,58
15	L	1/2" BSPT	AKL 15 R 1/2	3,63	STA AKL 15 R 1/2	2,06
18	L	1/2" BSPT	AKL 18 R 1/2	4,83	STA AKL 18 R 1/2	2,64
22	L	3/4" BSPT	AKL 22 R 3/4	6,43	STA AKL 22 R 3/4	3,50
6	S	1/4" BSPT	AKS 6 R 1/4	2,30	STA AKS 6 R 1/4	1,34
8	S	1/4" BSPT	AKS 8 R 1/4	2,53	STA AKS 8 R 1/4	1,52
10	S	3/8" BSPT	AKS 10 R 3/8	2,78	STA AKS 10 R 3/8	1,53
12	S	3/8" BSPT	AKS 12 R 3/8	3,26	STA AKS 12 R 3/8	1,95
16	S	1/2" BSPT	AKS 16 R 1/2	5,18	STA AKS 16 R 1/2	2,98
20	S	3/4" BSPT	AKS 20 R 3/4	8,67	STA AKS 20 R 3/4	5,54

## Racor recto rosca cilíndrica BSP 60°

Straight male stud coupling BSP cyl. 60°

Union simple mâle gaz cylindrique 60°

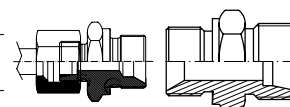

Raccordo di estremità diritto BSP 60°

T.	S.	THREAD ROSCA	Part nº Referencia	€	Part Nº STA Referencia STA	€
6	L	1/8" BSP	AL 6 RC 1/8	1,91	STA AL 6 RC 1/8	0,99
6	L	1/4" BSP	AL 6 RC 1/4	2,15	STA AL 6 RC 1/4	1,23
6	L	1/2" BSP	AL 6 RC 1/2	2,78	STA AL 6 RC 1/2	1,86
6	L	3/8" BSP	AL 6 RC 3/8	2,55	STA AL 6 RC 3/8	1,63
10	L	1/2" BSP	AL 8 RC 1/8	2,03	STA AL 8 RC 1/8	1,13
8	L	1/4" BSP	AL 8 RC 1/4	2,20	STA AL 8 RC 1/4	1,30
8	L	3/8" BSP	AL 8 RC 3/8	2,63	STA AL 8 RC 3/8	1,73
8	L	1/2" BSP	AL 8 RC 1/2	3,66	STA AL 8 RC 1/2	2,76
10	L	1/8" BSP	AL 10 RC 1/8	2,65	STA AL 10 RC 1/8	1,57
10	L	1/4" BSP	AL 10 RC 1/4	2,30	STA AL 10 RC 1/4	1,22
10	L	3/8" BSP	AL 10 RC 3/8	2,69	STA AL 10 RC 3/8	1,61
10	L	1/2" BSP	AL 10 RC 1/2	3,18	STA AL 10 RC 1/2	2,10
12	L	1/4" BSP	AL 12 RC 1/4	2,70	STA AL 12 RC 1/4	1,51
12	L	3/8" BSP	AL 12 RC 3/8	2,43	STA AL 12 RC 3/8	1,24
12	L	1/2" BSP	AL 12 RC 1/2	3,26	STA AL 12 RC 1/2	2,07
12	L	3/4" BSP	AL 12 RC 3/4	3,95	STA AL 12 RC 3/4	2,76
15	L	3/8" BSP	AL 15 RC 3/8	3,30	STA AL 15 RC 3/8	1,73
15	L	1/2" BSP	AL 15 RC 1/2	3,64	STA AL 15 RC 1/2	2,07
15	L	3/4" BSP	AL 15 RC 3/4	4,24	STA AL 15 RC 3/4	2,67
18	L	3/8" BSP	AL 18 RC 3/8	4,05	STA AL 18 RC 3/8	1,86
18	L	1/2" BSP	AL 18 RC 1/2	4,35	STA AL 18 RC 1/2	2,16
18	L	3/4" BSP	AL 18 RC 3/4	6,04	STA AL 18 RC 3/4	3,85
22	L	1/2" BSP	AL 22 RC 1/2	6,37	STA AL 22 RC 1/2	3,44
22	L	3/4" BSP	AL 22 RC 3/4	6,19	STA AL 22 RC 3/4	3,26
22	L	1" BSP	AL 22 RC 1	10,27	STA AL 22 RC 1	7,34
28	L	3/4" BSP	AL 28 RC 3/4	11,18	STA AL 28 RC 3/4	6,98
28	L	1" BSP	AL 28 RC 1	10,51	STA AL 28 RC 1	6,31
35	L	1" BSP	AL 35 RC 1	17,23	STA AL 35 RC 1	10,74
35	L	1" 1/4 BSP	AL 35 RC 1 1/4	16,82	STA AL 35 RC 1 1/4	10,33
42	L	1" 1/2 BSP	AL 42 RC 1 1/2	23,65	STA AL 42 RC 1 1/2	14,48
6	S	1/4" BSP	AS 6 RC 1/4	2,48	STA AS 6 RC 1/4	1,52
8	S	1/4" BSP	AS 8 RC 1/4	2,45	STA AS 8 RC 1/4	1,44
8	S	3/8" BSP	AS 8 RC 3/8	2,94	STA AS 8 RC 3/8	1,93
10	S	1/4" BSP	AS 10 RC 1/4	2,91	STA AS 10 RC 1/4	1,66
10	S	3/8" BSP	AS 10 RC 3/8	3,16	STA AS 10 RC 3/8	1,91
10	S	1/2" BSP	AS 10 RC 1/2	3,49	STA AS 10 RC 1/2	2,24
12	S	1/4" BSP	AS 12 RC 1/4	3,16	STA AS 12 RC 1/4	1,85
12	S	3/8" BSP	AS 12 RC 3/8	3,14	STA AS 12 RC 3/8	1,83
12	S	1/2" BSP	AS 12 RC 1/2	3,81	STA AS 12 RC 1/2	2,50
14	S	3/8" BSP	AS 14 RC 3/8	4,02	STA AS 14 RC 3/8	1,96
14	S	1/2" BSP	AS 14 RC 1/2	4,75	STA AS 14 RC 1/2	2,69
16	S	3/8" BSP	AS 16 RC 3/8	4,80	STA AS 16 RC 3/8	2,60
16	S	1/2" BSP	AS 16 RC 1/2	4,78	STA AS 16 RC 1/2	2,58
16	S	3/4" BSP	AS 16 RC 3/4	6,11	STA AS 16 RC 3/4	3,91
20	S	1/2" BSP	AS 20 RC 1/2	7,59	STA AS 20 RC 1/2	4,46
20	S	3/4" BSP	AS 20 RC 3/4	7,12	STA AS 20 RC 3/4	3,99
25	S	3/4" BSP	AS 25 RC 3/4	11,85	STA AS 25 RC 3/4	6,54
25	S	1" BSP	AS 25 RC 1	11,27	STA AS 25 RC 1	5,96
30	S	1" BSP	AS 30 RC 1	15,85	STA AS 30 RC 1	8,06
30	S	1" 1/4 BSP	AS 30 RC 1 1/4	18,12	STA AS 30 RC 1 1/4	10,33
38	S	1" 1/4 BSP	AS 38 RC 1 1/4	17,56	STA AS 38 RC 1 1/4	7,58
38	S	1" 1/2 BSP	AS 38 RC 1 1/2	23,41	STA AS 38 RC 1 1/2	13,43

# Racores DIN 2353

DIN 2353 Pipe fittings

Raccords à bague DIN 2353

Raccordi ad anello DIN 2353

## Racor recto rosca cilíndrica BSP

Straight male stud coupling BSP cyl

Union simple mâle gaz cyl

Raccordo di estremità diritto BSP

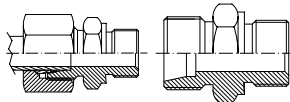

T.	S.	THREAD ROSCA	Part nº Referencia	€	Part Nº STA Referencia STA	€
6	L	1/8" BSP	AL 6 R 1/8	1,91	STA AL 6 R 1/8	0,99
6	L	1/4" BSP	AL 6 R 1/4	2,15	STA AL 6 R 1/4	1,23
6	L	3/8" BSP	AL 6 R 3/8	2,55	STA AL 6 R 3/8	1,63
6	L	1/2" BSP	AL 6 R 1/2	2,78	STA AL 6 R 1/2	1,86
8	L	1/8" BSP	AL 8 R 1/8	2,03	STA AL 8 R 1/8	1,13
8	L	1/4" BSP	AL 8 R 1/4	2,20	STA AL 8 R 1/4	1,30
8	L	3/8" BSP	AL 8 R 3/8	2,63	STA AL 8 R 3/8	1,73
8	L	1/2" BSP	AL 8 R 1/2	3,66	STA AL 8 R 1/2	2,76
10	L	1/8" BSP	AL 10 R 1/8	2,65	STA AL 10 R 1/8	1,57
10	L	1/4" BSP	AL 10 R 1/4	2,30	STA AL 10 R 1/4	1,22
10	L	3/8" BSP	AL 10 R 3/8	2,69	STA AL 10 R 3/8	1,61
10	L	1/2" BSP	AL 10 R 1/2	3,18	STA AL 10 R 1/2	2,10
12	L	1/4" BSP	AL 12 R 1/4	2,70	STA AL 12 R 1/4	1,51
12	L	1/2" BSP	AL 12 R 1/2	3,26	STA AL 12 R 1/2	2,07
12	L	3/4" BSP	AL 12 R 3/4	3,95	STA AL 12 R 3/4	2,76
12	L	3/8" BSP	AL 12 R 3/8	2,43	STA AL 12 R 3/8	1,24
15	L	3/8" BSP	AL 15 R 3/8	3,30	STA AL 15 R 3/8	1,73
15	L	1/2" BSP	AL 15 R 1/2	3,64	STA AL 15 R 1/2	2,07
15	L	3/4" BSP	AL 15 R 3/4	4,24	STA AL 15 R 3/4	2,67
18	L	1/2" BSP	AL 18 R 1/2	4,35	STA AL 18 R 1/2	2,16
18	L	3/4" BSP	AL 18 R 3/4	6,04	STA AL 18 R 3/4	3,85
18	L	3/8" BSP	AL 18 R 3/8	4,05	STA AL 18 R 3/8	1,86
22	L	1/2" BSP	AL 22 R 1/2	6,37	STA AL 22 R 1/2	3,44
22	L	3/4" BSP	AL 22 R 3/4	6,19	STA AL 22 R 3/4	3,26
22	L	1" BSP	AL 22 R 1	10,27	STA AL 22 R 1	7,34
28	L	3/4" BSP	AL 28 R 3/4	11,18	STA AL 28 R 3/4	6,98
28	L	1" BSP	AL 28 R 1	10,51	STA AL 28 R 1	6,31
35	L	1" BSP	AL 35 R 1	17,23	STA AL 35 R 1	10,74
35	L	1 1/4" BSP	AL 35 R 1 1/4	16,82	STA AL 35 R 1 1/4	10,33
42	L	1 1/2" BSP	AL 42 R 1 1/2	23,65	STA AL 42 R 1 1/2	14,48
6	S	1/4" BSP	AS 6 R 1/4	2,48	STA AS 6 R 1/4	1,52
8	S	1/4" BSP	AS 8 R 1/4	2,45	STA AS 8 R 1/4	1,44
8	S	3/8" BSP	AS 8 R 3/8	2,94	STA AS 8 R 3/8	1,93
10	S	1/4" BSP	AS 10 R 1/4	2,91	STA AS 10 R 1/4	1,66
10	S	3/8" BSP	AS 10 R 3/8	3,16	STA AS 10 R 3/8	1,91
10	S	1/2" BSP	AS 10 R 1/2	3,49	STA AS 10 R 1/2	2,24
12	S	1/4" BSP	AS 12 R 1/4	3,16	STA AS 12 R 1/4	1,85
12	S	3/8" BSP	AS 12 R 3/8	3,14	STA AS 12 R 3/8	1,83
12	S	1/2" BSP	AS 12 R 1/2	3,81	STA AS 12 R 1/2	2,50
14	S	3/8" BSP	AS 14 R 3/8	4,02	STA AS 14 R 3/8	1,96
14	S	1/2" BSP	AS 14 R 1/2	4,75	STA AS 14 R 1/2	2,69
16	S	3/8" BSP	AS 16 R 3/8	4,80	STA AS 16 R 3/8	2,60
16	S	1/2" BSP	AS 16 R 1/2	4,78	STA AS 16 R 1/2	2,58
16	S	3/4" BSP	AS 16 R 3/4	6,11	STA AS 16 R 3/4	3,91
20	S	1/2" BSP	AS 20 R 1/2	7,59	STA AS 20 R 1/2	4,46
20	S	3/4" BSP	AS 20 R 3/4	7,12	STA AS 20 R 3/4	3,99
25	S	3/4" BSP	AS 25 R 3/4	11,85	STA AS 25 R 3/4	6,54
25	S	1" BSP	AS 25 R 1	11,27	STA AS 25 R 1	5,96
30	S	1" BSP	AS 30 R 1	15,85	STA AS 30 R 1	8,06
30	S	1 1/4" BSP	AS 30 R 1 1/4	18,12	STA AS 30 R 1 1/4	10,33
38	S	1 1/4" BSP	AS 38 R 1 1/4	17,56	STA AS 38 R 1 1/4	7,58
38	S	1 1/2" BSP	AS 38 R 1 1/2	23,41	STA AS 38 R 1 1/2	13,43

Hasta fin de existencias / Until end of stock / Jusqu'à la fin du stock / Fino ad esaurimento scorta

## Racor recto rosca cilíndrica BSP con junta

Straight male stud coupling with captive seal BSP cyl

Union simple mâle gaz cyl avec joint plat

Raccordo di estremità diritto BSP con guarnizione

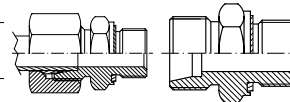

T.	S.	THREAD ROSCA	Part nº Referencia	€	Part Nº STA Referencia STA	€
6	L	1/8" BSP	AL 6 R 1/8 WD	2,23	STA AL 6 R 1/8 WD	1,31
6	L	1/4" BSP	AL 6 R 1/4 WD	2,63	STA AL 6 R 1/4 WD	1,71
6	L	3/8" BSP	AL 6 R 3/8 WD	2,80	STA AL 6 R 3/8 WD	1,88
8	L	1/8" BSP	AL 8 R 1/8 WD	2,14	STA AL 8 R 1/8 WD	1,24
8	L	1/4" BSP	AL 8 R 1/4 WD	2,30	STA AL 8 R 1/4 WD	1,40
8	L	3/8" BSP	AL 8 R 3/8 WD	2,54	STA AL 8 R 3/8 WD	1,64
8	L	1/2" BSP	AL 8 R 1/2 WD	4,11	STA AL 8 R 1/2 WD	3,21
10	L	1/8" BSP	AL 10 R 1/8 WD	2,69	STA AL 10 R 1/8 WD	1,61
10	L	1/4" BSP	AL 10 R 1/4 WD	2,28	STA AL 10 R 1/4 WD	1,20
10	L	3/8" BSP	AL 10 R 3/8 WD	2,72	STA AL 10 R 3/8 WD	1,64
10	L	1/2" BSP	AL 10 R 1/2 WD	3,43	STA AL 10 R 1/2 WD	2,35
12	L	1/4" BSP	AL 12 R 1/4 WD	2,54	STA AL 12 R 1/4 WD	1,35
12	L	3/8" BSP	AL 12 R 3/8 WD	2,64	STA AL 12 R 3/8 WD	1,45
12	L	1/2" BSP	AL 12 R 1/2 WD	3,54	STA AL 12 R 1/2 WD	2,35
12	L	3/4" BSP	AL 12 R 3/4 WD	5,65	STA AL 12 R 3/4 WD	4,46
15	L	3/8" BSP	AL 15 R 3/8 WD	3,79	STA AL 15 R 3/8 WD	2,22
15	L	1/2" BSP	AL 15 R 1/2 WD	3,92	STA AL 15 R 1/2 WD	2,35
15	L	3/4" BSP	AL 15 R 3/4 WD	5,68	STA AL 15 R 3/4 WD	4,11
18	L	3/8" BSP	AL 18 R 3/8 WD	5,16	STA AL 18 R 3/8 WD	2,97
18	L	1/2" BSP	AL 18 R 1/2 WD	4,69	STA AL 18 R 1/2 WD	2,50
18	L	3/4" BSP	AL 18 R 3/4 WD	5,65	STA AL 18 R 3/4 WD	3,46
22	L	1/2" BSP	AL 22 R 1/2 WD	6,37	STA AL 22 R 1/2 WD	3,44
22	L	3/4" BSP	AL 22 R 3/4 WD	6,43	STA AL 22 R 3/4 WD	3,50
22	L	1" BSP	AL 22 R 1 WD	9,41	STA AL 22 R 1 WD	6,48
28	L	3/4" BSP	AL 28 R 3/4 WD	10,68	STA AL 28 R 3/4 WD	6,48
28	L	1" BSP	AL 28 R 1 WD	11,19	STA AL 28 R 1 WD	6,99
35	L	1 1/4" BSP	AL 35 R 1 1/4 WD	17,48	STA AL 35 R 1 1/4 WD	10,99
42	L	1 1/2" BSP	AL 42 R 1 1/2 WD	25,40	STA AL 42 R 1 1/2 WD	16,23
6	S	1/4" BSP	AS 6 R 1/4 WD	2,68	STA AS 6 R 1/4 WD	1,72
8	S	1/4" BSP	AS 8 R 1/4 WD	2,61	STA AS 8 R 1/4 WD	1,60
8	S	3/8" BSP	AS 8 R 3/8 WD	3,19	STA AS 8 R 3/8 WD	2,18
10	S	1/4" BSP	AS 10 R 1/4 WD	3,01	STA AS 10 R 1/4 WD	1,76
10	S	3/8" BSP	AS 10 R 3/8 WD	3,55	STA AS 10 R 3/8 WD	2,30
10	S	1/2" BSP	AS 10 R 1/2 WD	3,42	STA AS 10 R 1/2 WD	2,17
12	S	1/4" BSP	AS 12 R 1/4 WD	3,27	STA AS 12 R 1/4 WD	1,96
12	S	3/8" BSP	AS 12 R 3/8 WD	3,22	STA AS 12 R 3/8 WD	1,91
12	S	1/2" BSP	AS 12 R 1/2 WD	4,00	STA AS 12 R 1/2 WD	2,69
14	S	3/4" BSP	AS 14 R 3/8 WD	4,64	STA AS 14 R 3/8 WD	2,58
14	S	1/2" BSP	AS 14 R 1/2 WD	4,97	STA AS 14 R 1/2 WD	2,91
16	S	3/8" BSP	AS 16 R 3/8 WD	4,77	STA AS 16 R 3/8 WD	2,57
16	S	1/2" BSP	AS 16 R 1/2 WD	4,84	STA AS 16 R 1/2 WD	2,64
16	S	3/4" BSP	AS 16 R 3/4 WD	4,96	STA AS 16 R 3/4 WD	2,76
20	S	1/2" BSP	AS 20 R 1/2 WD	8,13	STA AS 20 R 1/2 WD	5,00
20	S	3/4" BSP	AS 20 R 3/4 WD	7,24	STA AS 20 R 3/4 WD	4,11
25	S	3/4" BSP	AS 25 R 3/4 WD	12,51	STA AS 25 R 3/4 WD	7,20
25	S	1" BSP	AS 25 R 1 WD	12,30	STA AS 25 R 1 WD	6,99
30	S	1" BSP	AS 30 R 1 WD	17,76	STA AS 30 R 1 WD	9,97
30	S	1 1/4" BSP	AS 30 R 1 1/4 WD	20,21	STA AS 30 R 1 1/4 WD	12,42
38	S	1 1/4" BSP	AS 38 R 1 1/4 WD	37,41	STA AS 38 R 1 1/4 WD	27,43
38	S	1 1/2" BSP	AS 38 R 1 1/2 WD	28,77	STA AS 38 R 1 1/2 WD	18,79

Tri-Flare Pipe

Pipe Fittings, DIN 2353 / Flare fittings, JIC 37°

SAE Flanges

Tri-Flare Clamps

Machines for processing rigid pipes

# Racores DIN 2353

DIN 2353 Pipe fittings  
Raccords à bague DIN 2353  
Raccordi ad anello DIN 2353

## Racor recto rosca cónica NPT

Straight male stud coupling NPT

Union simple mâle NPT

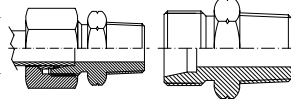

Raccordo di estremità diritto NPT conico

T.	S.	THREAD ROSCA	Part nº Referencia	€	Part Nº STA Referencia STA	€
6	LL	1/8" NPT	AKLL 6 1/8 NPT	1,90	STA AKLL 6 1/8 NPT	1,05
8	LL	1/8" NPT	AKLL 8 1/8 NPT	2,78	*	*
6	L	1/8" NPT	AKL 6 1/8 NPT	2,05	STA AKL 6 1/8 NPT	1,13
6	L	1/4" NPT	AKL 6 1/4 NPT	2,38	STA AKL 6 1/4 NPT	1,46
8	L	1/4" NPT	AKL 8 1/4 NPT	2,30	STA AKL 8 1/4 NPT	1,40
10	L	1/4" NPT	AKL 10 1/4 NPT	2,94	STA AKL 10 1/4 NPT	1,86
10	L	3/8" NPT	AKL 10 3/8 NPT	3,31	STA AKL 10 3/8 NPT	2,23
12	L	1/4" NPT	AKL 12 1/4 NPT	2,53	STA AKL 12 1/4 NPT	1,34
12	L	3/8" NPT	AKL 12 3/8 NPT	2,98	STA AKL 12 3/8 NPT	1,79
12	L	1/2" NPT	AKL 12 1/2 NPT	3,93	STA AKL 12 1/2 NPT	2,74
15	L	1/2" NPT	AKL 15 1/2 NPT	4,36	STA AKL 15 1/2 NPT	2,79
18	L	1/2" NPT	AKL 18 1/2 NPT	5,15	STA AKL 18 1/2 NPT	2,96
22	L	3/4" NPT	AKL 22 3/4 NPT	7,09	STA AKL 22 3/4 NPT	4,16
28	L	1" NPT	AKL 28 1 NPT	14,80	STA AKL 28 1 NPT	10,60
35	L	1 1/4" NPT	AKL 35 1 1/4 NPT	29,30	STA AKL 35 1 1/4 NPT	22,81
42	L	1 1/2" NPT	AKL 42 1 1/2 NPT	40,10	STA AKL 42 1 1/2 NPT	30,93
6	S	1/4" NPT	AKS 6 1/4 NPT	2,41	STA AKS 6 1/4 NPT	1,45
8	S	1/4" NPT	AKS 8 1/4 NPT	2,95	STA AKS 8 1/4 NPT	1,94
10	S	1/4" NPT	AKS 10 1/4 NPT	2,36	STA AKS 10 1/4 NPT	1,11
10	S	3/8" NPT	AKS 10 3/8 NPT	3,44	STA AKS 10 3/8 NPT	2,19
12	S	3/8" NPT	AKS 12 3/8 NPT	4,05	STA AKS 12 3/8 NPT	2,74
12	S	1/2" NPT	AKS 12 1/2 NPT	3,76	STA AKS 12 1/2 NPT	2,45
14	S	1/2" NPT	AKS 14 1/2 NPT	4,47	STA AKS 14 1/2 NPT	2,41
16	S	1/2" NPT	AKS 16 1/2 NPT	5,39	STA AKS 16 1/2 NPT	3,19
20	S	3/4" NPT	AKS 20 3/4 NPT	7,81	STA AKS 20 3/4 NPT	4,68
25	S	1" NPT	AKS 25 1 NPT	12,87	STA AKS 25 1 NPT	7,56
30	S	1 1/4" NPT	AKS 30 1 1/4 NPT	32,16	STA AKS 30 1 1/4 NPT	24,37
38	S	1 1/2" NPT	AKS 38 1 1/2 NPT	44,68	STA AKS 38 1 1/2 NPT	34,70

## Racor recto rosca cilíndrica UNF

Straight male stud coupling UNF

Union simple mâle UNF

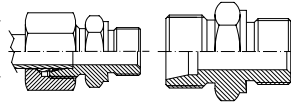

Raccordo di estremità diritto UNF

T.	S.	THREAD ROSCA	Part nº Referencia	€	Part Nº STA Referencia STA	€
10	L	7/16" UNF	AL 10 7/16 UNF	*	STA AL 10 7/16 UNF	2,11
12	L	3/4" UNF	AL 12 3/4 UNF	*	STA AL 12 3/4 UNF	10,83
12	L	7/8" UNF	AL 12 7/8 UNF	*	STA AL 12 7/8 UNF	3,54
15	L	3/4" UNF	AL 15 3/4 UNF	*	STA AL 15 3/4 UNF	3,66
18	L	3/4" UNF	AL 18 3/4 UNF	*	STA AL 18 3/4 UNF	3,53
18	L	7/8" UNF	AL 18 7/8 UNF	*	STA AL 18 7/8 UNF	3,46
22	L	7/8" UNF	AL 22 7/8 UNF	*	STA AL 22 7/8 UNF	15,09
22	L	1" 1/16 UNF	AL 22 1 1/16 UNF	*	STA AL 22 1 1/16 UNF	15,42
22	L	1" 5/16 UNF	AL 22 1 5/16 UNF	*	STA AL 22 1 5/16 UNF	18,91
28	L	1" 1/16 UNF	AL 28 1 1/16 UNF	*	STA AL 28 1 1/16 UNF	19,12
28	L	1" 5/16 UNF	AL 28 1 5/16 UNF	*	STA AL 28 1 5/16 UNF	19,21
35	L	1" 5/16 UNF	AL 35 1 5/16 UNF	*	STA AL 35 1 5/16 UNF	24,84
35	L	1" 5/8 UNF	AL 35 1 5/8 UNF	*	STA AL 35 1 5/8 UNF	28,32
8	S	7/16" UNF	AS 8 7/16 UNF	*	STA AS 8 7/16 UNF	9,24
10	S	9/16" UNF	AS 10 9/16 UNF	*	STA AS 10 9/16 UNF	9,99
12	S	9/16" UNF	AS 12 9/16 UNF	*	STA AS 12 9/16 UNF	10,82
20	S	3/4" UNF	AS 20 3/4 UNF	*	STA AS 20 3/4 UNF	15,53
20	S	7/8" UNF	AS 20 7/8 UNF	*	STA AS 20 7/8 UNF	16,14
20	S	1" 1/16 UNF	AS 20 1 1/16 UNF	*	STA AS 20 1 1/16 UNF	16,90
25	S	1" 5/16 UNF	AS 25 1 5/16 UNF	*	STA AS 25 1 5/16 UNF	20,62

## Racor recto rosca cilíndrica Métrica con junta

Straight male stud coupling with captive seal Metrical cyl

Union simple mâle Métrique cyl + joint plat

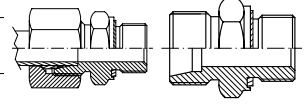

Raccordo di estremità diritto cilindrico Metrico con guarnizione

T.	S.	THREAD ROSCA	Part nº Referencia	€	Part Nº STA Referencia STA	€
6	L	M10x1	AL 6 M 10X1 WD	2,24	STA AL 6 M 10X1 WD	1,32
8	L	M12x1,5	AL 8 M 12X1.5 WD	2,60	STA AL 8 M 12X1.5 WD	1,70
10	L	M14x1,5	AL 10 M 14X1.5 WD	2,60	STA AL 10 M 14X1.5 WD	1,52
10	L	M16x1,5	AL 10 M 16X1.5 WD	3,45	STA AL 10 M 16X1.5 WD	2,37
10	L	M18x1,5	AL 10 M 18X1.5 WD	4,28	STA AL 10 M 18X1.5 WD	3,20
10	L	M22x1,5	AL 10 M 22X1.5 WD	4,71	STA AL 10 M 22X1.5 WD	3,63
12	L	M16x1,5	AL 12 M 16X1.5 WD	3,08	STA AL 12 M 16X1.5 WD	1,89
12	L	M22x1,5	AL 12 M 22X1.5 WD	4,81	STA AL 12 M 22X1.5 WD	3,62
15	L	M18x1,5	AL 15 M 18X1.5 WD	4,40	STA AL 15 M 18X1.5 WD	2,83
15	L	M22x1,5	AL 15 M 22X1.5 WD	5,24	STA AL 15 M 22X1.5 WD	3,67
18	L	M18x1,5	AL 18 M 18X1.5 WD	11,71	STA AL 18 M 18X1.5 WD	9,52
18	L	M22x1,5	AL 18 M 22X1.5 WD	5,14	STA AL 18 M 22X1.5 WD	2,95
22	L	M26x1,5	AL 22 M 26X1.5 WD	8,59	STA AL 22 M 26X1.5 WD	5,66
28	L	M33x2	AL 28 M 33X2 WD	11,76	STA AL 28 M 33X2 WD	7,56
35	L	M42x2	AL 35 M 42X2 WD	21,39	STA AL 35 M 42X2 WD	14,90
42	L	M48x2	AL 42 M 48X2 WD	36,88	STA AL 42 M 48X2 WD	27,71
6	S	M12x1,5	AS 6 M 12X1.5 WD	2,33	STA AS 6 M 12X1.5 WD	1,37
10	S	M16x1,5	AS 10 M 16X1.5 WD	3,23	STA AS 10 M 16X1.5 WD	1,98
12	S	M18x1,5	AS 12 M 18X1.5 WD	4,34	STA AS 12 M 18X1.5 WD	3,03
14	S	M20x1,5	AS 14 M 20X1.5 WD	4,71	STA AS 14 M 20X1.5 WD	2,65
16	S	M22x1,5	AS 16 M 22X1.5 WD	6,15	STA AS 16 M 22X1.5 WD	3,95
25	S	M33x2	AS 25 M 33X2 WD	12,22	STA AS 25 M 33X2 WD	6,91
30	S	M42x2	AS 30 M 42X2 WD	19,84	STA AS 30 M 42X2 WD	12,05
38	S	M48x2	AS 38 M 48X2 WD	26,05	STA AS 38 M 48X2 WD	16,07

## Racor recto rosca cónica Métrica

Straight male stud coupling metrical tapered

Union simple mâle métrique type A

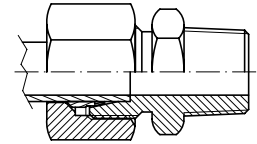

Raccordo di estremità diritto conico Metrico

PIPE TUBO	SERIE	THREAD ROSCA	Part nº Referencia	€
4	LL	M 8x1	AKLL 4 M 8X1	2,08
6	LL	M 10x1	AKLL 6 M 10X1	2,04
8	LL	M 10x1	AKLL 8 M 10X1	2,16

# Racores DIN 2353

DIN 2353 Pipe fittings  
Raccords à bague DIN 2353  
Raccordi ad anello DIN 2353

## Reducción con rosca M-HF BSP con junta

Male-female reducing adaptor BSP cyl with captive seal

Réduction mâle gaz-femelle gaz avec joint plat

Adattatore di riduzione filettato maschio-femmina BSP con guarnizione

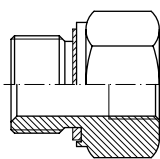

THREAD ROSCA		Part nº Referencia	€
M 1/8" BSP	F 1/4" BSP	<b>RI-R 1/8 R 1/4WD</b>	<b>1,90</b>
M 1/8" BSP	F 3/8" BSP	<b>RI-R 1/8 R 3/8WD</b>	<b>2,76</b>
M 1/4" BSP	F 1/8" BSP	<b>RI-R 1/4 R 1/8WD</b>	<b>1,86</b>
M 1/4" BSP	F 3/8" BSP	<b>RI-R 1/4 R 3/8WD</b>	<b>2,94</b>
M 1/4" BSP	F 1/2" BSP	<b>RI-R 1/4 R 1/2 WD</b>	<b>5,00</b>
M 1/4" BSP	F 3/4" BSP	<b>RI-R 1/4 R 3/4 WD</b>	<b>13,15</b>
M 3/8" BSP	F 1/8" BSP	<b>RI-R 3/8 R 1/8WD</b>	<b>2,03</b>
M 3/8" BSP	F 1/4" BSP	<b>RI-R 3/8 R 1/4 WD</b>	<b>2,54</b>
M 3/8" BSP	F 1/2" BSP	<b>RI-R 3/8 R 1/2WD</b>	<b>5,05</b>
M 3/8" BSP	F 3/4" BSP	<b>RI-R 3/8 R 3/4WD</b>	<b>7,40</b>
M 1/2" BSP	F 1/8" BSP	<b>RI-R 1/2 R 1/8WD</b>	<b>2,98</b>
M 1/2" BSP	F 1/4" BSP	<b>RI-R 1/2 R 1/4WD</b>	<b>2,94</b>
M 1/2" BSP	F 3/8" BSP	<b>RI-R 1/2 R 3/8WD</b>	<b>3,63</b>
M 1/2" BSP	F 3/4" BSP	<b>RI-R 1/2 R 3/4WD</b>	<b>7,60</b>
M 1/2" BSP	F 1" BSP	<b>RI-R 1/2 R 1WD</b>	<b>9,36</b>
M 1/2" BSP	F 1 1/4 BSP	<b>RI-R 1/2 R 1 1/4WD</b>	<b>26,78</b>
M 3/4" BSP	F 1/4" BSP	<b>RI-R 3/4 R 1/4WD</b>	<b>4,63</b>
M 3/4" BSP	F 3/8" BSP	<b>RI-R 3/4 R 3/8WD</b>	<b>4,63</b>
M 3/4" BSP	F 1/2" BSP	<b>RI-R 3/4 R 1/2WD</b>	<b>5,69</b>
M 3/4" BSP	F 1" BSP	<b>RI-R 3/4 R 1WD</b>	<b>9,67</b>
M 3/4" BSP	F 1 1/4 BSP	<b>RI-R 3/4 R 1 1/4WD</b>	<b>17,95</b>
M 3/4" BSP	F 1 1/2 BSP	<b>RI-R 3/4 R 1 1/2WD</b>	<b>32,49</b>
M 1" BSP	F 1/4" BSP	<b>RI-R 1 R 1/4WD</b>	<b>7,55</b>
M 1" BSP	F 3/8" BSP	<b>RI-R 1 R 3/8WD</b>	<b>7,55</b>
M 1" BSP	F 1/2" BSP	<b>RI-R 1 R 1/2WD</b>	<b>7,55</b>
M 1" BSP	F 3/4" BSP	<b>RI-R 1 R 3/4WD</b>	<b>9,51</b>
M 1" BSP	F 1 1/4 BSP	<b>RI-R 1 R 1 1/4WD</b>	<b>18,68</b>
M 1" BSP	F 1 1/2 BSP	<b>RI-R 1 R 1 1/2WD</b>	<b>33,28</b>
M 1 1/4 BSP	F 1/2" BSP	<b>RI-R 1 1/4 R 1/2WD</b>	<b>11,96</b>
M 1 1/4 BSP	F 3/4" BSP	<b>RI-R 1 1/4 R 3/4WD</b>	<b>11,96</b>
M 1 1/4 BSP	F 1" BSP	<b>RI-R 1 1/4 R 1WD</b>	<b>15,38</b>
M 1 1/4 BSP	F 1 1/2 BSP	<b>RI-R 1 1/4 R 1 1/2WD</b>	<b>34,08</b>
M 1 1/2 BSP	F 1/2" BSP	<b>RI-R 1 1/2 R 1/2WD</b>	<b>14,78</b>
M 1 1/2 BSP	F 3/4" BSP	<b>RI-R 1 1/2 R 3/4WD</b>	<b>14,78</b>
M 1 1/2 BSP	F 1" BSP	<b>RI-R 1 1/2 R 1WD</b>	<b>14,78</b>
M 1 1/2 BSP	F 1 1/4 BSP	<b>RI-R 1 1/2 R 1 1/4WD</b>	<b>19,58</b>

# Racores DIN 2353

DIN 2353 Pipe fittings

Raccords à bague DIN 2353

Raccordi ad anello DIN 2353

## Racor en codo rosca cónica BSPT

Male stud elbow BSPT conical

Union coude mâle conique BSPT

Raccordo a gomito, conico BSPT

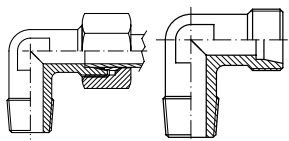

T.	S.	THREAD ROSCA	Part nº Referencia	€	Part Nº STA Referencia STA	€
4	LL	1/8" BSPT	CKLL 4 R 1/8	3,52	STA CKLL 4 R 1/8	2,68
6	LL	1/8" BSPT	CKLL 6 R 1/8	3,53	STA CKLL 6 R 1/8	2,68
8	LL	1/8" BSPT	CKLL 8 R 1/8	4,07	STA CKLL 8 R 1/8	3,11
6	L	1/8" BSPT	CKL 6 R 1/8	3,57	STA CKL 6 R 1/8	2,65
6	L	1/4" BSPT	CKL 6 R 1/4	3,82	STA CKL 6 R 1/4	2,90
8	L	1/8" BSPT	CKL 8 R 1/8	4,54	STA CKL 8 R 1/8	3,64
8	L	1/4" BSPT	CKL 8 R 1/4	4,22	STA CKL 8 R 1/4	3,32
8	L	3/8" BSPT	CKL 8 R 3/8	5,74	STA CKL 8 R 3/8	4,84
10	L	1/4" BSPT	CKL 10 R 1/4	4,46	STA CKL 10 R 1/4	3,38
10	L	3/8" BSPT	CKL 10 R 3/8	4,46	STA CKL 10 R 3/8	3,38
10	L	1/2" BSPT	CKL 10 R 1/2	7,56	STA CKL 10 R 1/2	6,48
12	L	1/4" BSPT	CKL 12 R 1/4	4,63	STA CKL 12 R 1/4	3,44
12	L	3/8" BSPT	CKL 12 R 3/8	4,43	STA CKL 12 R 3/8	3,24
12	L	1/2" BSPT	CKL 12 R 1/2	6,72	STA CKL 12 R 1/2	5,53
15	L	3/8" BSPT	CKL 15 R 3/8	6,51	STA CKL 15 R 3/8	4,94
15	L	1/2" BSPT	CKL 15 R 1/2	7,11	STA CKL 15 R 1/2	5,54
18	L	1/2" BSPT	CKL 18 R 1/2	10,29	STA CKL 18 R 1/2	8,10
22	L	3/4" BSPT	CKL 22 R 3/4	13,07	STA CKL 22 R 3/4	10,14
28	L	1" BSPT	CKL 28 R 1	24,65	STA CKL 28 R 1	20,45
35	L	1 1/4" BSPT	CKL 35 R 1 1/4	38,19	STA CKL 35 R 1 1/4	31,70
42	L	1 1/2" BSPT	CKL 42 R 1 1/2	58,81	STA CKL 42 R 1 1/2	49,64
6	S	1/4" BSPT	CKS 6 R 1/4	4,71	STA CKS 6 R 1/4	3,75
8	S	1/4" BSPT	CKS 8 R 1/4	5,29	STA CKS 8 R 1/4	4,28
10	S	3/8" BSPT	CKS 10 R 3/8	6,11	STA CKS 10 R 3/8	4,86
12	S	3/8" BSPT	CKS 12 R 3/8	6,51	STA CKS 12 R 3/8	5,20
12	S	1/2" BSPT	CKS 12 R 1/2	6,25	STA CKS 12 R 1/2	4,94
14	S	1/2" BSPT	CKS 14 R 1/2	11,25	STA CKS 14 R 1/2	9,19
16	S	1/2" BSPT	CKS 16 R 1/2	8,65	STA CKS 16 R 1/2	6,45
20	S	3/4" BSPT	CKS 20 R 3/4	17,55	STA CKS 20 R 3/4	14,42
25	S	1" BSPT	CKS 25 R 1	33,33	STA CKS 25 R 1	28,02
30	S	1 1/4" BSPT	CKS 30 R 1 1/4	56,50	STA CKS 30 R 1 1/4	48,71
38	S	1 1/2" BSPT	CKS 38 R 1 1/2	80,96	STA CKS 38 R 1 1/2	70,98

## Racor en codo rosca cónica Métrica

Male stud elbow Metrical conical

Union coude mâle conique Métrique

Raccordo a gomito, conico Metrico

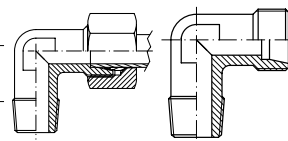

T.	S.	THREAD ROSCA	Part nº Referencia	€	Part Nº STA Referencia STA	€
4	LL	M8x1	CKLL 4 M 8X1	3,39	STA CKLL 4 M 8X1	2,55
6	LL	M10x1	CKLL 6 M 10X1	3,62	STA CKLL 6 M 10X1	2,77
8	LL	M10x1	CKLL 8 M 10X1	4,23	STA CKLL 8 M 10X1	3,27
6	L	M10x1	CKL 6 M 10X1	4,53	STA CKL 6 M 10X1	3,61
8	L	M12x1,5	CKL 8 M 12X1.5	4,72	STA CKL 8 M 12X1.5	*
10	L	M14x1,5	CKL 10 M 14X1.5	5,85	STA CKL 10 M 14X1.5	*
12	L	M16x1,5	CKL 12 M 16X1.5	6,60	STA CKL 12 M 16X1.5	5,41
15	L	M18x1,5	CKL 15 M 18X1.5	8,83	STA CKL 15 M 18X1.5	7,26
6	S	M12x1,5	CKS 6 M 12X1.5	23,12	STA CKS 6 M 12X1.5	22,16
8	S	M14x1,5	CKS 8 M 14X1.5	23,73	STA CKS 8 M 14X1.5	22,72
10	S	M16x1,5	CKS 10 M 16X1.5	6,71	STA CKS 10 M 16X1.5	5,46
14	S	M20x1,5	CKS 14 M 20X1.5	27,62	STA CKS 14 M 20X1.5	25,56
16	S	M22x1,5	CKS 16 M 22X1.5	31,41	STA CKS 16 M 22X1.5	29,21

## Racor en codo rosca cónica NPT

Male stud elbow NPTconical

Union coude mâle gaz conique NPT

Raccordo a gomito, conico NPT

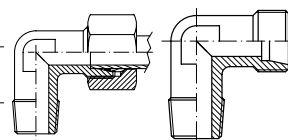

T.	S.	THREAD ROSCA	Part nº Referencia	€	Part Nº STA Referencia STA	€
4	LL	1/8" NPT	CKLL 4 1/8 NPT	6,72	STA CKLL 4 1/8 NPT	5,88
6	LL	1/8" NPT	CKLL 6 1/8 NPT	3,34	STA CKLL 6 1/8 NPT	2,49
8	LL	1/8" NPT	CKLL 8 1/8 NPT	7,26		*
6	L	1/8" NPT	CKL 6 1/8 NPT	2,95	STA CKL 6 1/8 NPT	2,03
6	L	1/4" NPT	CKL 6 1/4 NPT	4,57	STA CKL 6 1/4 NPT	3,65
8	L	1/4" NPT	CKL 8 1/4 NPT	4,55	STA CKL 8 1/4 NPT	3,65
10	L	1/4" NPT	CKL 10 1/4 NPT	5,24	STA CKL 10 1/4 NPT	4,16
12	L	1/4" NPT	CKL 12 1/4 NPT	6,00	STA CKL 12 1/4 NPT	4,81
12	L	3/8" NPT	CKL 12 3/8 NPT	5,85	STA CKL 12 3/8 NPT	4,66
12	L	1/2" NPT	CKL 12 1/2 NPT	7,69	STA CKL 12 1/2 NPT	6,50
15	L	1/2" NPT	CKL 15 1/2 NPT	8,82	STA CKL 15 1/2 NPT	7,25
18	L	1/2" NPT	CKL 18 1/2 NPT	10,29	STA CKL 18 1/2 NPT	8,10
22	L	3/4" NPT	CKL 22 3/4 NPT	16,11	STA CKL 22 3/4 NPT	13,18
28	L	1" NPT	CKL 28 1 NPT	24,65	STA CKL 28 1 NPT	20,45
35	L	1 1/4" NPT	CKL 35 1 1/4 NPT	55,20	STA CKL 35 1 1/4 NPT	48,71
42	L	1 1/2" NPT	CKL 42 1 1/2 NPT	80,15	STA CKL 42 1 1/2 NPT	70,98
6	S	1/4" NPT	CKS 6 1/4 NPT	6,87	STA CKS 6 1/4 NPT	5,91
8	S	1/4" NPT	CKS 8 1/4 NPT	7,98	STA CKS 8 1/4 NPT	6,97
10	S	3/8" NPT	CKS 10 3/8 NPT	8,66	STA CKS 10 3/8 NPT	7,41
12	S	3/8" NPT	CKS 12 3/8 NPT	6,85	STA CKS 12 3/8 NPT	5,54
14	S	1/2" NPT	CKS 14 1/2 NPT	24,80	STA CKS 14 1/2 NPT	22,74
16	S	1/2" NPT	CKS 16 1/2 NPT	10,08	STA CKS 16 1/2 NPT	7,88
20	S	3/4" NPT	CKS 20 3/4 NPT	14,60	STA CKS 20 3/4 NPT	11,47
25	S	1" NPT	CKS 25 1 NPT	24,69	STA CKS 25 1 NPT	19,38
30	S	1 1/4" NPT	CKS 30 1 1/4 NPT	56,50	STA CKS 30 1 1/4 NPT	48,71
38	S	1 1/2" NPT	CKS 38 1 1/2 NPT	80,96	STA CKS 38 1 1/2 NPT	70,98

# Racores DIN 2353

DIN 2353 Pipe fittings  
Raccords à bague DIN 2353  
Raccordi ad anello DIN 2353

Tubing Pipe

Pipe Fittings DIN 2353 / Flare fittings JIC 37°

SAE Flanges

Tubing Clamps

Machines for processing rigid pipes

## Racor de reducción TL Métrica (serie ligera)

Standpipe reducer swivel female (light series)

Union simple femelle tournante Métrique (L)

Raccordo di riduzione cono 24 (L)

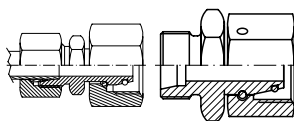

T.	S.	Part nº Referencia	€	Part Nº STA Referencia STA	€
6	8	L KORL 8-6TLM	4,88	STA KORL 8-6TLM	3,06
6	10	L KORL 10-6TLM	5,53	STA KORL 10-6 TLM	3,53
8	10	L KORL 10-8 TLM	4,79	STA KORL 10-8 TLM	2,81
6	12	L KORL 12-6TLM	5,38	STA KORL 12-6 TLM	3,27
8	12	L KORL 12-8TLM	3,95	STA KORL 12-8 TLM	1,86
10	12	L KORL 12-10TLM	5,69	STA KORL 12-10 TLM	3,42
6	15	L KORL 15-6TLM	14,70	STA KORL 15-6 TLM	12,21
8	15	L KORL 15-8TLM	7,78	STA KORL 15-8 TLM	5,31
10	15	L KORL 15-10TLM	6,74	STA KORL 15-10 TLM	4,09
12	15	L KORL 15-12TLM	6,55	STA KORL 15-12 TLM	3,79
6	18	L KORL 18-6TLM	18,24	STA KORL 18-6 TLM	15,13
8	18	L KORL 18-8TLM	18,23	STA KORL 18-8 TLM	15,14
10	18	L KORL 18-10TLM	8,47	STA KORL 18-10 TLM	5,20
12	18	L KORL 18-12TLM	9,87	STA KORL 18-12 TLM	6,49
15	18	L KORL 18-15TLM	11,07	STA KORL 18-15 TLM	7,31
6	22	L KORL 22-6TLM *	19,62		*
8	22	L KORL 22-8TLM *	19,85		*
10	22	L KORL 22-10TLM	20,88	STA KORL 22-10 TLM	16,87
12	22	L KORL 22-12TLM	13,25	STA KORL 22-12 TLM	9,13
15	22	L KORL 22-15TLM	13,63	STA KORL 22-15 TLM	9,13
18	22	L KORL 22-18TLM	12,87	STA KORL 22-18 TLM	7,75
6	28	L KORL 28-6TLM *	23,84		*
10	28	L KORL 28-10TLM *	24,40		*
12	28	L KORL 28-12TLM	26,13	STA KORL 28-12 TLM	20,74
15	28	L KORL 28-15TLM	18,42	STA KORL 28-15 TLM	12,65
18	28	L KORL 28-18TLM	19,04	STA KORL 28-18 TLM	12,65
22	28	L KORL 28-22TLM	17,01	STA KORL 28-22 TLM	9,88
15	35	L KORL 35-15TLM	37,67	STA KORL 35-15 TLM	29,61
18	35	L KORL 35-18TLM	38,29	STA KORL 35-18 TLM	29,61
22	35	L KORL 35-22TLM	25,64	STA KORL 35-22 TLM	16,22
28	35	L KORL 35-28TLM	33,21	STA KORL 35-28 TLM	22,52
18	42	L KORL 42-18TLM	57,88	STA KORL 42-18 TLM	46,52
22	42	L KORL 42-22TLM	59,16	STA KORL 42-22 TLM	47,06
28	42	L KORL 42-28TLM	60,74	STA KORL 42-28 TLM	47,37
35	42	L KORL 42-35TLM	39,66	STA KORL 42-35 TLM	24,00

\*Hasta fin de existencias / \*Until end of stock / \*Jusqu'à la fin du stock / \*Fino ad esaurimento scorta

## Racor de reducción TL Métrica (serie pesada)

Standpipe reducer swivel female (heavy series)

Union simple femelle tournante Métrique (S)

Raccordo di riduzione cono 24 (S)

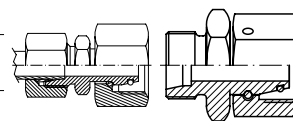

T.	S.	Part nº Referencia	€	Part Nº STA Referencia STA	€
6	8	S KORS 8-6TLM	12,63	STA KORS 8-6 TLM	10,66
6	10	S KORS 10-6TLM	13,88	STA KORS 10-6 TLM	11,67
8	10	S KORS 10-8TLM	13,82	STA KORS 10-8 TLM	11,56
6	12	S KORS 12-6TLM	14,14	STA KORS 12-6 TLM	11,87
8	12	S KORS 12-8TLM	14,19	STA KORS 12-8 TLM	11,87
10	12	S KORS 12-10TLM	7,61	STA KORS 12-10 TLM	5,05
6	14	S KORS 14-6TLM	16,44	STA KORS 14-6 TLM	13,46
8	14	S KORS 14-8TLM	16,55	STA KORS 14-8 TLM	13,48
10	14	S KORS 14-10TLM	16,79	STA KORS 14-10 TLM	13,48
12	14	S KORS 14-12TLM	8,22	STA KORS 14-12 TLM	4,85
8	16	S KORS 16-8TLM	10,25	STA KORS 16-8 TLM	7,04
10	16	S KORS 16-10TLM	19,01	STA KORS 16-10 TLM	15,56
12	16	S KORS 16-12TLM	9,08	STA KORS 16-12 TLM	5,57
14	16	S KORS 16-14TLM	20,56	STA KORS 16-14 TLM	16,30
6	20	S KORS 20-6TLM	22,55	STA KORS 20-6 TLM	18,64
8	20	S KORS 20-8TLM	22,78	STA KORS 20-8 TLM	18,64
10	20	S KORS 20-10TLM	23,02	STA KORS 20-10 TLM	18,64
12	20	S KORS 20-12TLM	14,89	STA KORS 20-12 TLM	10,45
14	20	S KORS 20-14TLM	17,54	STA KORS 20-14 TLM	12,35
16	20	S KORS 20-16TLM	14,17	STA KORS 20-16 TLM	8,84
6	25	S KORS 25-6TLM	29,10	STA KORS 25-6 TLM	22,83
8	25	S KORS 25-8TLM	29,15	STA KORS 25-8 TLM	22,83
10	25	S KORS 25-10TLM	29,39	STA KORS 25-10 TLM	22,83
12	25	S KORS 25-12TLM	20,16	STA KORS 25-12 TLM	13,54
14	25	S KORS 25-14TLM	30,81	STA KORS 25-14 TLM	23,44
16	25	S KORS 25-16TLM	17,21	STA KORS 25-16 TLM	9,70
20	25	S KORS 25-20TLM	19,69	STA KORS 25-20 TLM	11,25
12	30	S KORS 30-12TLM	37,33	STA KORS 30-12 TLM	*
16	30	S KORS 30-16TLM	40,53	STA KORS 30-16 TLM	*
20	30	S KORS 30-20TLM	34,75	STA KORS 30-20 TLM	*
25	30	S KORS 30-25TLM	42,11	STA KORS 30-25 TLM	*
16	38	S KORS 38-16TLM	55,64	STA KORS 38-16 TLM	*
20	38	S KORS 38-20TLM	60,24	STA KORS 38-20 TLM	*
25	38	S KORS 38-25TLM	67,80	STA KORS 38-25 TLM	*
30	38	S KORS 38-30TLM	72,81	STA KORS 38-30 TLM	*

## Racor en codo regulable con tuerca y anillo

Adjustable stud elbow with nut and ring

Coude orientable tube lisse équipé

Raccordo orientabile a 90° con dado e anello

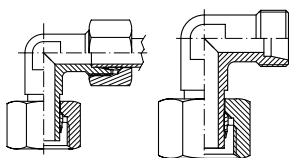

PIPE TUBO	SERIE	THREAD ROSCA	Part nº Referencia	€	Part Nº STA Referencia STA	€
6	L	M12x1,5	EEL 6 CTA	5,99	STA EEL 6 CTA	5,07
8	L	M14x1,5	EEL 8 CTA	6,47	STA EEL 8 CTA	5,58
15	L	M22x1,5	EEL 15 CTA	8,53	STA EEL 15 CTA	6,96
18	L	M26x1,5	EEL 18 CTA	10,64	STA EEL 18 CTA	8,45
22	L	M30x2	EEL 22 CTA	14,71	STA EEL 22 CTA	11,78
12	S	M20x1,5	EES 12 CTA	*	STA EES 12 CTA	6,12
25	S	M36x2	EES 25 CTA	29,78	STA EES 25 CTA	24,47

Hasta fin de existencias. / Until end of stock. / Jusqu'à la fin du stock. / Fino ad esaurimento scorta.

# Racores DIN 2353

DIN 2353 Pipe fittings  
Raccords à bague DIN 2353  
Raccordi ad anello DIN 2353

## Racor en codo tubo-TL Métrica

Adjustable stud elbow with o'ring

Coude orientable Métrique + o'ring

Raccordo orientabile a 90° con o'ring

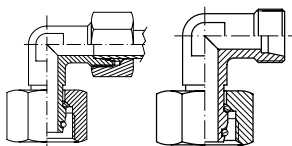

PIPE TUBO	SERIE	THREAD ROSCA	Part nº Referencia	€	Part Nº STA Referencia STA	€
6	L	M12x1,5	EEL 6 TLM	5,99	STA EEL 6 TLM	5,07
8	L	M14x1,5	EEL 8 TLM	6,48	STA EEL 8 TLM	5,58
10	L	M16x1,5	EEL 10 TLM	5,90	STA EEL 10 TLM	4,82
12	L	M18x1,5	EEL 12 TLM	6,08	STA EEL 12 TLM	4,89
15	L	M22x1,5	EEL 15 TLM	8,53	STA EEL 15 TLM	6,96
18	L	M26x1,5	EEL 18 TLM	10,64	STA EEL 18 TLM	8,45
22	L	M30x2	EEL 22 TLM	14,71	STA EEL 22 TLM	11,78
28	L	M36x2	EEL 28 TLM	22,41	STA EEL 28 TLM	18,21
35	L	M45x2	EEL 35 TLM	43,98	STA EEL 35 TLM	37,49
42	L	M52x2	EEL 42 TLM	67,53	STA EEL 42 TLM	58,36
6	S	M14x1,5	EES 6 TLM	5,85	STA EES 6 TLM	4,89
8	S	M16x1,5	EES 8 TLM	6,52	STA EES 8 TLM	5,51
10	S	M18x1,5	EES 10 TLM	7,37	STA EES 10 TLM	6,12
12	S	M20x1,5	EES 12 TLM	7,43	STA EES 12 TLM	6,12
14	S	M22x1,5	EES 14 TLM	9,77	STA EES 14 TLM	7,71
16	S	M24x1,5	EES 16 TLM	12,60	STA EES 16 TLM	10,40
20	S	M30x2	EES 20 TLM	16,59	STA EES 20 TLM	13,46
25	S	M36x2	EES 25 TLM	29,78	STA EES 25 TLM	24,47
30	S	M42x2	EES 30 TLM	47,02	STA EES 30 TLM	39,23
38	S	M52x2	EES 38 TLM	69,47	STA EES 38 TLM	59,49

## Racor en L tubo-TL Métrica

Adjustable stud barrel L with o'ring

L Orientable renversé Métrique + o'ring

Raccordo orientabile a T con o'ring laterale

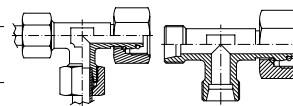

PIPE TUBO	SERIE	THREAD ROSCA	Part nº Referencia	€	Part Nº STA Referencia STA	€
6	L	M12x1,5	LEL 6 TLM	7,38	STA LEL 6 TLM	5,54
8	L	M14x1,5	LEL 8 TLM	7,56	STA LEL 8 TLM	5,76
10	L	M16x1,5	LEL 10 TLM	8,05	STA LEL 10 TLM	5,89
12	L	M18x1,5	LEL 12 TLM	9,31	STA LEL 12 TLM	6,93
15	L	M22x1,5	LEL 15 TLM	12,08	STA LEL 15 TLM	8,94
18	L	M26x1,5	LEL 18 TLM	15,63	STA LEL 18 TLM	11,25
22	L	M30x2	LEL 22 TLM	22,48	STA LEL 22 TLM	16,62
28	L	M36x2	LEL 28 TLM	36,81	STA LEL 28 TLM	28,41
35	L	M45x2	LEL 35 TLM	49,69	STA LEL 35 TLM	36,71
42	L	M52x2	LEL 42 TLM	75,69	STA LEL 42 TLM	57,35
6	S	M14x1,5	LES 6 TLM	8,06	STA LES 6 TLM	6,14
8	S	M16x1,5	LES 8 TLM	8,56	STA LES 8 TLM	6,54
10	S	M18x1,5	LES 10 TLM	11,68	STA LES 10 TLM	9,18
12	S	M20x1,5	LES 12 TLM	12,28	STA LES 12 TLM	9,66
14	S	M22x1,5	LES 14 TLM	16,02	STA LES 14 TLM	11,90
16	S	M24x1,5	LES 16 TLM	16,84	STA LES 16 TLM	12,44
20	S	M30x2	LES 20 TLM	22,90	STA LES 20 TLM	16,64
25	S	M36x2	LES 25 TLM	42,74	STA LES 25 TLM	32,12
30	S	M42x2	LES 30 TLM	55,65	STA LES 30 TLM	40,07
38	S	M52x2	LES 38 TLM	84,85	STA LES 38 TLM	64,89

## Racor en T tubo-TL Métrica

Adjustable stud branch TEE with o'ring

Té Orientable Métrique + o'ring

Raccordo orientabile a T con o'ring centrale

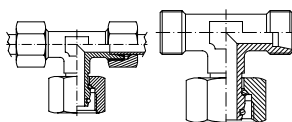

PIPE TUBO	SERIE	THREAD ROSCA	Part nº Referencia	€	Part Nº STA Referencia STA	€
6	L	M12x1,5	TEL 6 TLM	7,38	STA TEL 6 TLM	5,54
8	L	M14x1,5	TEL 8 TLM	7,56	STA TEL 8 TLM	5,76
10	L	M16x1,5	TEL 10 TLM	8,05	STA TEL 10 TLM	5,89
12	L	M18x1,5	TEL 12 TLM	9,28	STA TEL 12 TLM	6,90
15	L	M22x1,5	TEL 15 TLM	12,08	STA TEL 15 TLM	8,94
18	L	M26x1,5	TEL 18 TLM	17,23	STA TEL 18 TLM	12,85
22	L	M30x2	TEL 22 TLM	21,53	STA TEL 22 TLM	15,67
28	L	M36x2	TEL 28 TLM	38,22	STA TEL 28 TLM	29,82
35	L	M45x2	TEL 35 TLM	49,69	STA TEL 35 TLM	36,71
42	L	M52x2	TEL 42 TLM	75,69	STA TEL 42 TLM	57,35
6	S	M14x1,5	TES 6 TLM	8,23	STA TES 6 TLM	6,31
8	S	M16x1,5	TES 8 TLM	8,54	STA TES 8 TLM	6,52
10	S	M18x1,5	TES 10 TLM	11,68	STA TES 10 TLM	9,18
12	S	M20x1,5	TES 12 TLM	11,20	STA TES 12 TLM	8,58
14	S	M22x1,5	TES 14 TLM	13,30	STA TES 14 TLM	9,18
16	S	M24x1,5	TES 16 TLM	17,25	STA TES 16 TLM	12,85
20	S	M30x2	TES 20 TLM	23,39	STA TES 20 TLM	17,13
25	S	M36x2	TES 25 TLM	42,74	STA TES 25 TLM	32,12
30	S	M42x2	TES 30 TLM	56,87	STA TES 30 TLM	41,29
38	S	M52x2	TES 38 TLM	100,00	STA TES 38 TLM	80,04

# Racores DIN 2353

DIN 2353 Pipe fittings  
Raccords à bague DIN 2353  
Raccordi ad anello DIN 2353

Tr/Ale pipe

Pipe fittings, DIN 2353  
/ Flare fittings, JIC 37°

SAE Flanges

Tr/Ale clamps

Machines for  
processing rigid pipes

## Racor unión TL-TL Métrica

*Straight connection with o'ring*

*Union tournante Métrique égale*

*Raccordo di estremità diritto Metrico con o'ring*

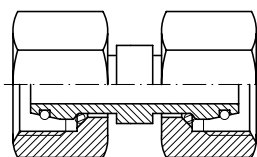

PIPE TUBO	SERIE	Part nº Referencia	€
6	L	<b>ATL 6</b>	<b>8,50</b>
8	L	<b>ATL 8</b>	<b>3,89</b>
10	L	<b>ATL 10</b>	<b>4,44</b>
12	L	<b>ATL 12</b>	<b>5,28</b>
15	L	<b>ATL 15</b>	<b>6,81</b>
18	L	<b>ATL 18</b>	<b>8,61</b>
22	L	<b>ATL 22</b>	<b>17,36</b>
28	L	<b>ATL 28</b>	<b>21,26</b>
35	L	<b>ATL 35</b>	<b>32,38</b>
42	L	<b>ATL 42</b>	<b>51,59</b>
6	S	<b>ATS 6</b>	<b>8,94</b>
8	S	<b>ATS 8</b>	<b>9,83</b>
10	S	<b>ATS 10</b>	<b>10,91</b>
12	S	<b>ATS 12</b>	<b>11,78</b>
14	S	<b>ATS 14</b>	<b>13,52</b>
16	S	<b>ATS 16</b>	<b>8,34</b>
20	S	<b>ATS 20</b>	<b>18,31</b>
25	S	<b>ATS 25</b>	<b>23,86</b>
30	S	<b>ATS 30</b>	<b>35,47</b>
38	S	<b>ATS 38</b>	<b>53,59</b>

## Tubo roscado recto BSP TLM con junta

*Straight stud standpipe adpt. w/captive seal & o'ring BSP cyl*

*Adapteur tube lisse x mâle gaz a/écrou + o'ring*

*Adattatore diritto BSP TLM*

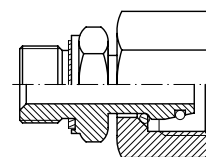

PIPE TUBO	SERIE	THREAD ROSCA	Part nº Referencia	€
6	L	1/8"BSP	<b>RAL 6 TLM R 1/8</b>	<b>2,40</b>
8	L	1/4"BSP	<b>RAL 8 TLM R 1/4</b>	<b>2,86</b>
10	L	1/4"BSP	<b>RAL 10 TLM R 1/4</b>	<b>3,75</b>
12	L	3/8"BSP	<b>RAL 12 TLM R 3/8</b>	<b>3,64</b>
15	L	1/2"BSP	<b>RAL 15 TLM R 1/2</b>	<b>4,58</b>
18	L	1/2"BSP	<b>RAL 18 TLM R 1/2</b>	<b>4,78</b>
22	L	3/4"BSP	<b>RAL 22 TLM R 3/4</b>	<b>5,86</b>
28	L	1"BSP	<b>RAL 28 TLM R 1</b>	<b>10,16</b>
35	L	1"1/4BSP	<b>RAL 35 TLM R 1 1/4</b>	<b>19,40</b>
42	L	1"1/2 BSP	<b>RAL 42 TLM R 1 1/2</b>	<b>27,72</b>
6	S	1/4"BSP	<b>RAS 6 TLM R 1/4</b>	<b>2,84</b>
8	S	1/4"BSP	<b>RAS 8 TLM R 1/4</b>	<b>3,02</b>
10	S	3/8"BSP	<b>RAS 10 TLM R 3/8</b>	<b>2,95</b>
12	S	3/8"BSP	<b>RAS 12 TLM R 3/8</b>	<b>3,96</b>
14	S	1/2"BSP	<b>RAS 14 TLM R 1/2</b>	<b>4,35</b>
16	S	1/2"BSP	<b>RAS 16 TLM R 1/2</b>	<b>4,94</b>
20	S	3/4"BSP	<b>RAS 20 TLM R 3/4</b>	<b>7,48</b>
25	S	1"BSP	<b>RAS 25 TLM R 1</b>	<b>12,94</b>
30	S	1"1/4BSP	<b>RAS 30 TLM R 1 1/4</b>	<b>21,89</b>
38	S	1"1/2BSP	<b>RAS 38 TLM R 1 1/2</b>	<b>35,14</b>

## Tubo roscado recto métrico TLM con junta

*Straight stud metric standpipe adpt. w/captive seal-o'ring Met. cyl*

*Adapteur tube lisse x mâle met.a/écrou Met.+o'ring*

*Adattatore diritto Metrico TLM*

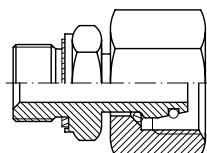

PIPE TUBO	SERIE	THREAD ROSCA	Part nº Referencia	€
6	L	M10X1	<b>RAL 6 TLM M 10X1</b>	<b>10,19</b>
8	L	M12X1.5	<b>RAL 8 TLM M 12X1.5</b>	<b>11,29</b>
10	L	M14X1.5	<b>RAL 10 TLM M 14X1.5</b>	<b>12,64</b>
12	L	M16X1.5	<b>RAL 12 TLM M 16X1.5</b>	<b>14,32</b>
15	L	M18X1.5	<b>RAL 15 TLM M 18X1.5</b>	<b>15,31</b>
18	L	M22X1.5	<b>RAL 18 TLM M 22X1.5</b>	<b>17,11</b>
22	L	M26X1.5	<b>RAL 22 TLM M 26X1.5</b>	<b>21,92</b>
28	L	M33X2	<b>RAL 28 TLM M 33X2</b>	<b>31,27</b>
35	L	M42X2	<b>RAL 35 TLM M 42X2</b>	<b>47,77</b>
42	L	M48X2	<b>RAL 42 TLM M 48X2</b>	<b>63,99</b>
6	S	M12X1.5	<b>RAS 6 TLM M 12X1.5</b>	<b>11,07</b>
8	S	M14X1.5	<b>RAS 8 TLM M 14X1.5</b>	<b>12,91</b>
10	S	M16X1.5	<b>RAS 10 TLM M 16X1.5</b>	<b>14,63</b>
12	S	M18X1.5	<b>RAS 12 TLM M 18X1.5</b>	<b>15,68</b>
14	S	M20X1.5	<b>RAS 14 TLM M 20X1.5</b>	<b>18,20</b>
16	S	M22X1.5	<b>RAS 16 TLM M 22X1.5</b>	<b>14,71</b>
20	S	M27X2	<b>RAS 20 TLM M 27X2</b>	<b>24,59</b>
25	S	M33X2	<b>RAS 25 TLM M 33X2</b>	<b>28,05</b>
30	S	M42X2	<b>RAS 30 TLM M 42X2</b>	<b>51,72</b>
38	S	M48X2	<b>RAS 38 TLM M 48X2</b>	<b>69,49</b>

# Racores DIN 2353

DIN 2353 Pipe fittings

Raccords à bague DIN 2353

Raccordi ad anello DIN 2353

## Racor recto para soldar

Welding straight coupling

Mamelon hexagonal à souder Métrique (DIN 2353) équipé avec bague et écrou

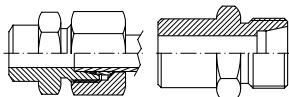

Raccordo diritto a saldare

PIPE TUBO	SERIE	Part n° Referencia	€	Part N° STA Referencia STA	€
6	L	ASL 6	2,01	STA ASL 6	1,09
8	L	ASL 8	2,12	STA ASL 8	1,22
10	L	ASL 10	2,46	STA ASL 10	1,38
12	L	ASL 12	2,58	STA ASL 12	1,39
15	L	ASL 15	3,17	STA ASL 15	1,60
18	L	ASL 18	4,57	STA ASL 18	2,38
22	L	ASL 22	6,79	STA ASL 22	3,86
28	L	ASL 28	10,63	STA ASL 28	6,43
35	L	ASL 35	15,15	STA ASL 35	8,66
42	L	ASL 42	22,89	STA ASL 42	13,72
6	S	ASS 6	9,61	STA ASS 6	8,65
8	S	ASS 8	10,25	STA ASS 8	9,24
10	S	ASS 10	5,31	STA ASS 10	4,06
12	S	ASS 12	6,43	STA ASS 12	5,12
14	S	ASS 14	4,28	STA ASS 14	2,22
16	S	ASS 16	5,09	STA ASS 16	2,89
20	S	ASS 20	7,15	STA ASS 20	4,02
25	S	ASS 25	12,76	STA ASS 25	7,45
30	S	ASS 30	16,74	STA ASS 30	8,95
38	S	ASS 38	24,47	STA ASS 38	14,49

## Racor pasatabique para soldar

Weldable bulkhead coupling

Union double passe cloison Métrique à souder

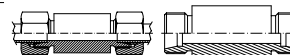

Raccordo passaparete a saldare

PIPE TUBO	SERIE	Part n° Referencia	€	Part N° STA Referencia STA	€
6	L	ESVL 6	16,58	STA ESVL 6	14,74
8	L	ESVL 8	16,22	STA ESVL 8	14,42
10	L	ESVL 10	20,01	STA ESVL 10	17,85
12	L	ESVL 12	18,28	STA ESVL 12	15,90
15	L	ESVL 15	24,45	STA ESVL 15	21,31
18	L	ESVL 18	29,25	STA ESVL 18	24,87
22	L	ESVL 22	28,74	STA ESVL 22	22,88
28	L	ESVL 28	31,71	STA ESVL 28	23,31
35	L	ESVL 35	49,50	STA ESVL 35	36,52
42	L	ESVL 42	65,39	STA ESVL 42	47,05
6	S	ESVS 6	17,06	STA ESVS 6	15,14
8	S	ESVS 8	20,38	STA ESVS 8	18,36
10	S	ESVS 10	18,84	STA ESVS 10	16,34
12	S	ESVS 12	21,47	STA ESVS 12	18,85
14	S	ESVS 14	29,66	STA ESVS 14	25,54
16	S	ESVS 16	26,23	STA ESVS 16	21,83
20	S	ESVS 20	28,52	STA ESVS 20	22,26
25	S	ESVS 25	42,49	STA ESVS 25	31,87
30	S	ESVS 30	55,35	STA ESVS 30	39,77
38	S	ESVS 38	70,17	STA ESVS 38	50,21

## Boquilla para soldar

Welding nipple

Collet cône Métrique (DIN 2353) à souder (BW)  
o'ring

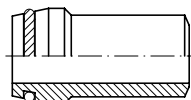

Ogiva a saldare

PIPE TUBO	SERIE	Part n° Referencia	€
15X2.5	L	ORIL 15	3,90
18X2.5	L	ORIL 18	4,51
22X2.5	L	ORIL 22	4,77
28X3	L	ORIL 28	5,98
35X4	L	ORIL 35	6,50
42X3	L	ORIL 42	7,40
6X2	L/S	ORIS 6	1,11
8X2	L/S	ORIS 8	1,20
8X1.5	L/S	ORIS 8X1.5	1,32
10X2	L/S	ORIS 10X2	1,43
12X2	L/S	ORIS 12	1,32
12X2.5	S	ORIS 12X2.5	1,65
14X2	L/S	ORIS 14X2	4,91
14X3	S	ORIS 14X3	10,29
16X2	S	ORIS 16X2	5,10
16X2.5	S	ORIS 16X2.5	5,10
16X3	S	ORIS 16X3	2,64
20X2.5	S	ORIS 20X2.5	6,96
20X3	S	ORIS 20X3	6,96
20X4	S	ORIS 20X4	2,97
25X4	S	ORIS 25X4	3,96
30x4	S	ORIS 30X4	11,54
30x5	S	ORIS 30X5	5,57
38x5	S	ORIS 38X5	9,35

# Racores DIN 2353

DIN 2353 Pipe fittings  
Raccords à bague DIN 2353  
Raccordi ad anello DIN 2353

Tri/Alle Pipe

Pipe fittings DIN 2353  
/ Flare fittings JIC 37°

SAE Flanges

Tri/Alle Clamps

Machines for  
processing rigid pipes

## Racor recto pasatabiques con tuerca

*Straight bulkhead coupling*

Union double passe cloison

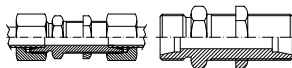

*Raccordo passaparete*

PIPE TUBO	SERIE	Part nº Referencia	€	Part Nº STA Referencia STA	€
6	L	SVL 6	3,95	STA SVL 6	2,11
8	L	SVL 8	4,40	STA SVL 8	2,60
10	L	SVL 10	5,29	STA SVL 10	3,13
12	L	SVL 12	6,23	STA SVL 12	3,85
15	L	SVL 15	7,95	STA SVL 15	4,81
18	L	SVL 18	11,30	STA SVL 18	6,92
22	L	SVL 22	15,06	STA SVL 22	9,20
28	L	SVL 28	20,84	STA SVL 28	12,44
35	L	SVL 35	33,53	STA SVL 35	20,55
42	L	SVL 42	49,37	STA SVL 42	31,03
6	S	SVS 6	4,93	STA SVS 6	3,01
8	S	SVS 8	5,38	STA SVS 8	3,36
10	S	SVS 10	6,53	STA SVS 10	4,03
12	S	SVS 12	7,66	STA SVS 12	5,04
14	S	SVS 14	11,32	STA SVS 14	7,20
16	S	SVS 16	11,98	STA SVS 16	7,58
20	S	SVS 20	17,79	STA SVS 20	11,53
25	S	SVS 25	29,69	STA SVS 25	19,07
30	S	SVS 30	40,78	STA SVS 30	25,20
38	S	SVS 38	89,66	STA SVS 38	69,70

## Racor en codo pasatabiques con tuerca

*Elbow bulkhead coupling*

Coude égal passe cloison

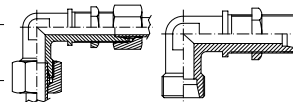

*Raccordo passaparete a 90°*

PIPE TUBO	SERIE	Part nº Referencia	€	Part Nº STA Referencia STA	€
6	L	USVL 6	7,64	STA USVL 6	5,80
8	L	USVL 8	7,75	STA USVL 8	5,95
10	L	USVL 10	8,22	STA USVL 10	6,06
12	L	USVL 12	10,38	STA USVL 12	8,00
15	L	USVL 15	11,82	STA USVL 15	8,68
18	L	USVL 18	15,51	STA USVL 18	11,13
22	L	USVL 22	19,58	STA USVL 22	13,72
28	L	USVL 28	34,25	STA USVL 28	25,85
35	L	USVL 35	45,97	STA USVL 35	32,99
42	L	USVL 42	74,50	STA USVL 42	56,16
8	S	USVS 8	9,65	STA USVS 8	7,63
10	S	USVS 10	9,81	STA USVS 10	7,31
12	S	USVS 12	11,22	STA USVS 12	8,60
14	S	USVS 14	12,52	STA USVS 14	8,40
16	S	USVS 16	16,23	STA USVS 16	11,83
20	S	USVS 20	22,98	STA USVS 20	16,72
25	S	USVS 25	39,15	STA USVS 25	28,53
30	S	USVS 30	51,24	STA USVS 30	35,66
38	S	USVS 38	86,82	STA USVS 38	66,86

## Tuerca pasatabiques Métrica

*Metric nut bulkhead*

Ecrou passe cloison Métrique

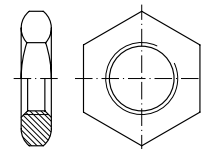

*Dado passaparete Metrico*

THREAD ROSCA	Part nº Referencia	€
M 12x1,5	TP 06 L	0,49
M 14x1,5	TP 08 L	0,62
M 16x1,5	TP 10 L	0,64
M 18x1,5	TP 12 L	0,76
M 22x1,5	TP 15 L	1,21
M 26x1,5	TP 18 L	1,82
M 30x2	TP 22 L	1,87
M 36x2	TP 28 L	2,29
M45x2	TP 35 L	2,45
M 52x2	TP 42 L	4,74
M 20x1,5	TP 12 S	0,89
M 24x1,5	TP 16 S	1,29
M 42x2	TP 30 S	2,45

# Racores DIN 2353

DIN 2353 Pipe fittings  
Raccords à bague DIN 2353  
Raccordi ad anello DIN 2353

## Racor recto hembra rosca BSP

Female stud coupling

Union simple femelle gaz

Raccordo diritto femmina BSP

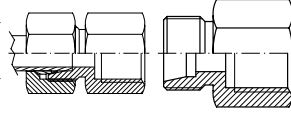

T.	S.	THREAD ROSCA	Part nº Referencia	€	Part Nº STA Referencia STA	€
6	L	1/8" BSP	<b>GAIL 6 R 1/8</b>	<b>2,60</b>	<b>STA GAIL 6 R 1/8</b>	<b>1,68</b>
8	L	1/4" BSP	<b>GAIL 8 R 1/4</b>	<b>2,63</b>	<b>STA GAIL 8 R 1/4</b>	<b>1,73</b>
10	L	1/4" BSP	<b>GAIL 10 R 1/4</b>	<b>2,86</b>	<b>STA GAIL 10 R 1/4</b>	<b>1,78</b>
10	L	3/8" BSP	<b>GAIL 10 R 3/8</b>	<b>3,21</b>	<b>STA GAIL 10 R 3/8</b>	<b>2,13</b>
10	L	1/2" BSP	<b>GAIL 10 R 1/2</b>	<b>4,98</b>	<b>STA GAIL 10 R 1/2</b>	<b>3,90</b>
12	L	3/8" BSP	<b>GAIL 12 R 3/8</b>	<b>3,30</b>	<b>STA GAIL 12 R 3/8</b>	<b>2,11</b>
12	L	1/2" BSP	<b>GAIL 12 R 1/2</b>	<b>4,00</b>	<b>STA GAIL 12 R 1/2</b>	<b>2,81</b>
15	L	3/4" BSP	<b>GAIL 15 R 1/2</b>	<b>4,21</b>	<b>STA GAIL 15 R 1/2</b>	<b>2,64</b>
18	L	1/2" BSP	<b>GAIL 18 R 1/2</b>	<b>4,97</b>	<b>STA GAIL 18 R 1/2</b>	<b>2,78</b>
22	L	3/4" BSP	<b>GAIL 22 R 3/4</b>	<b>7,35</b>	<b>STA GAIL 22 R 3/4</b>	<b>4,42</b>
28	L	1" BSP	<b>GAIL 28 R 1</b>	<b>11,43</b>	<b>STA GAIL 28 R 1</b>	<b>7,23</b>
35	L	1"1/4 BSP	<b>GAIL 35 R 1 1/4</b>	<b>40,83</b>	<b>STA GAIL 35 R 1 1/4</b>	<b>34,34</b>
42	L	1"1/2 BSP	<b>GAIL 42 R 1 1/2</b>	<b>50,21</b>	<b>STA GAIL 42 R 1 1/2</b>	<b>41,04</b>
6	S	1/4" BSP	<b>GAIS 6 R 1/4</b>	<b>3,12</b>	<b>STA GAIS 6 R 1/4</b>	<b>2,16</b>
8	S	1/4" BSP	<b>GAIS 8 R 1/4</b>	<b>3,17</b>	<b>STA GAIS 8 R 1/4</b>	<b>2,16</b>
10	S	3/8" BSP	<b>GAIS 10 R 3/8</b>	<b>4,46</b>	<b>STA GAIS 10 R 3/8</b>	<b>3,21</b>
14	S	1/2" BSP	<b>GAIS 14 R 1/2</b>	<b>5,31</b>	<b>STA GAIS 14 R 1/2</b>	<b>3,25</b>
16	S	1/2" BSP	<b>GAIS 16 R 1/2</b>	<b>5,66</b>	<b>STA GAIS 16 R 1/2</b>	<b>3,46</b>
20	S	3/4" BSP	<b>GAIS 20 R 3/4</b>	<b>9,10</b>	<b>STA GAIS 20 R 3/4</b>	<b>5,97</b>
25	S	1" BSP	<b>GAIS 25 R 1</b>	<b>13,34</b>	<b>STA GAIS 25 R 1</b>	<b>8,03</b>
30	S	1"1/4 BSP	<b>GAIS 30 R 1 1/4</b>	<b>43,25</b>	<b>STA GAIS 30 R 1 1/4</b>	<b>35,46</b>
38	S	1"1/2 BSP	<b>GAIS 38 R 1 1/2</b>	<b>57,68</b>	<b>STA GAIS 38 R 1 1/2</b>	<b>47,70</b>

## Arandela para manómetros

Seal for gauge coupling

Bague pour manomètres

Guarnizioni per manometri

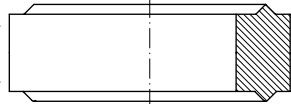

THREAD ROSCA	Part nº Referencia	€
1/4" BSP	<b>AM 1/4</b>	<b>0,50</b>
1/2" BSP	<b>AM 1/2</b>	<b>0,79</b>

## Racor recto hembra rosca Métrica

Female stud coupling Metric cyl

Union simple femelle Métrique

Raccordo diritto femmina Metrico

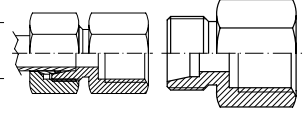

T.	S.	THREAD ROSCA	Part nº Referencia	€	Part Nº STA Referencia STA	€
6	L	M10x1	<b>GAIL 6 M 10X1</b>	<b>8,99</b>	<b>STA GAIL 6 M 10X1</b>	<b>8,07</b>
8	L	M12x1,5	<b>GAIL 8 M 12X1.5</b>	<b>9,73</b>	<b>STA GAIL 8 M 12X1.5</b>	<b>8,83</b>
10	L	M14X1.5	<b>GAIL 10 M14X1.5</b>	<b>10,60</b>	<b>STA GAIL 10 M 14X1.5</b>	<b>9,52</b>
12	L	M16X1.5	<b>GAIL 12 M16X1.5</b>	<b>11,62</b>	<b>STA GAIL 12 M 16X1.5</b>	<b>10,43</b>
15	L	M18X1.5	<b>GAIL 15 M18X1.5</b>	<b>13,06</b>	<b>STA GAIL 15 M 18X1.5</b>	<b>11,49</b>
16	S	M22x1,5	<b>GAIS 16 M 22X1.5</b>	<b>16,53</b>	<b>STA GAIS 16 M 22X1.5</b>	<b>14,33</b>
18	L	M22X1.5	<b>GAIL 18 M22X1.5</b>	<b>16,35</b>	<b>STA GAIL 18 M 22X1.5</b>	<b>14,16</b>
22	L	M26X1.5	<b>GAIL 22 M26X1.5</b>	<b>17,95</b>	<b>STA GAIL 22 M 26X1.5</b>	<b>15,02</b>
6	S	M12x1,5	<b>GAIS 6 M 12X1.5</b>	<b>9,84</b>	<b>STA GAIS 6 M 12X1.5</b>	<b>8,88</b>
8	S	M14x1,5	<b>GAIS 8 M 14X1.5</b>	<b>10,58</b>	<b>STA GAIS 8 M 14X1.5</b>	<b>9,57</b>
10	S	M16X1.5	<b>GAIS 10 M16X1.5</b>	<b>11,73</b>	<b>STA GAIS 10 M 16X1.5</b>	<b>10,48</b>
12	S	M18X1.5	<b>GAIS 12 M18X1.5</b>	<b>12,55</b>	<b>STA GAIS 12 M 18X1.5</b>	<b>11,24</b>
14	S	M20X1.5	<b>GAIS 14 M20X1.5</b>	<b>14,28</b>	<b>STA GAIS 14 M 20X1.5</b>	<b>12,22</b>
20	S	M27x2	<b>GAIS 20 M 27X2</b>	<b>19,96</b>	<b>STA GAIS 20 M 27X2</b>	<b>16,83</b>

## Racor para manómetro BSP

Gauge coupling BSP cyl

Union pour manomètre gaz

Raccordo per manometri BSP

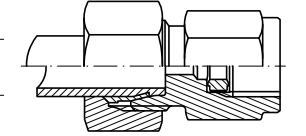

PIPE TUBO	SERIE	THREAD ROSCA	Part nº Referencia	€
6	L	1/4" BSP	<b>MAVL 6 R 1/4</b>	<b>2,70</b>
8	L	1/4" BSP	<b>MAVL 8 R 1/4</b>	<b>2,68</b>
10	L	1/4" BSP	<b>MAVL 10 R 1/4</b>	<b>2,86</b>
12	L	1/4" BSP	<b>MAVL 12 R 1/4</b>	<b>2,92</b>
6	S	1/2" BSP	<b>MAVS 6 R 1/2</b>	<b>8,32</b>
8	S	1/2" BSP	<b>MAVS 8 R 1/2</b>	<b>8,48</b>
10	S	1/2" BSP	<b>MAVS 10 R 1/2</b>	<b>8,79</b>
12	S	1/2" BSP	<b>MAVS 12 R 1/2</b>	<b>9,21</b>

# Racores DIN 2353

DIN 2353 Pipe fittings  
Raccords à bague DIN 2353  
Raccordi ad anello DIN 2353

## Racor en codo orientable sin estrangulador rosca BSP

Elbow banjo coupling with captive seal and o-ring  
BSP cyl

Equerre orientable sans étrangleur gaz BSP  
(passage total)

Raccordo orientabile a 90° ad occhio BSP con  
guarnizione

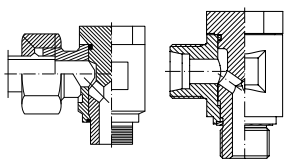

T.	S.	THREAD ROSCA	Part n° Referencia	€	Part N° STA Referencia STA	€
6	LL	1/8" BSP	WSVLL 6 R 1/8	10,02	STA WSVLL 6 R 1/8	9,17
8	LL	1/8" BSP	WSVLL 8 R 1/8	10,13	STA WSVLL 8 R 1/8	9,17
6	LL	1/8" BSP	WSVL 6 R 1/8	9,60	STA WSVL 6 R 1/8	8,68
8	L	1/4" BSP	WSVL 8 R 1/4	11,53	STA WSVL 8 R 1/4	10,63
10	L	1/4" BSP	WSVL 10 R 1/4	9,60	STA WSVL 10 R 1/4	8,52
12	L	1/4" BSP	WSVL 12 R 1/4	16,60	STA WSVL 12 R 1/4	15,41
12	L	3/8" BSP	WSVL 12 R 3/8	11,97	STA WSVL 12 R 3/8	10,78
15	L	1/2" BSP	WSVL 15 R 1/2	21,92	STA WSVL 15 R 1/2	20,35
18	L	1/2" BSP	WSVL 18 R 1/2	24,79	STA WSVL 18 R 1/2	22,60
22	L	3/4" BSP	WSVL 22 R 3/4	37,54	STA WSVL 22 R 3/4	34,61
28	L	1" BSP	WSVL 28 R 1	77,00	STA WSVL 28 R 1	72,80
35	L	1 1/4" BSP	WSVL 35 R 1 1/4	127,32	STA WSVL 35 R 1 1/4	120,83
42	L	1 1/2" BSP	WSVL 42 R 1 1/2	163,05	STA WSVL 42 R 1 1/2	153,88
6	L	1/4" BSP	WSVS 6 R 1/4	13,19	STA WSVS 6 R 1/4	12,23
8	S	1/4" BSP	WSVS 8 R 1/4	13,25	STA WSVS 8 R 1/4	12,24
10	S	3/8" BSP	WSVS 10 R 3/8	15,73	STA WSVS 10 R 3/8	14,48
12	S	3/8" BSP	WSVS 12 R 3/8	16,98	STA WSVS 12 R 3/8	15,67
14	S	1/2" BSP	WSVS 14 R 1/2	23,74	STA WSVS 14 R 1/2	21,68
16	S	1/2" BSP	WSVS 16 R 1/2	22,98	STA WSVS 16 R 1/2	20,78
20	S	3/4" BSP	WSVS 20 R 3/4	34,30	STA WSVS 20 R 3/4	31,17
25	S	1" BSP	WSVS 25 R 1	78,11	STA WSVS 25 R 1	72,80
30	S	1 1/4" BSP	WSVS 30 R 1 1/4	128,62	STA WSVS 30 R 1 1/4	120,83
38	S	1 1/2" BSP	WSVS 38 R 1 1/2	163,86	STA WSVS 38 R 1 1/2	153,88

## Racor en codo orientable sin estrangulador rosca Métrica

Elbow banjo coupling with captive seal and o-ring  
metric cyl

Equerre orientable sans étrangleur métrique  
(passage total)

Raccordo orientabile a 90° ad occhio Metrico con  
guarnizione

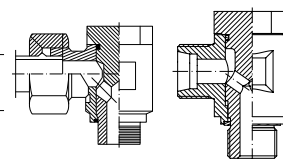

T.	S.	THREAD ROSCA	B	Part n° Referencia	€	Part N° STA Referencia STA	€
6	LL	M10X1	8	WSVLL 6 M 10X1	11,23	STA WSVLL 6 M 10X1	10,38
8	LL	M10X1	8	WSVLL 8 M 10X1	11,34	STA WSVLL 8 M 10X1	10,38
6	L	M10X1	8	WSVL 6 M 10X1	11,30	STA WSVL 6 M 10X1	10,38
8	L	M12X1.5	12	WSVL 8 M 12X1.5	14,67	STA WSVL 8 M 12X1.5	13,77
10	L	M14X1.5	12	WSVL 10 M 14X1.5	14,85	STA WSVL 10 M 14X1.5	13,77
12	L	M16X1.5	12	WSVL 12 M 16X1.5	19,93	STA WSVL 12 M 16X1.5	18,74
15	L	M18X1.5	12	WSVL 15 M 18X1.5	25,35	STA WSVL 15 M 18X1.5	23,78
18	L	M22X1.5	14	WSVL 18 M 22X1.5	28,23	STA WSVL 18 M 22X1.5	26,04
22	L	M26X1.5	16	WSVL 22 M 26X1.5	49,80	STA WSVL 22 M 26X1.5	46,87
28	L	M33X2	18	WSVL 28 M 33X2	86,14	STA WSVL 28 M 33X2	81,94
35	L	M42X2	20	WSVL 35 M 42X2	142,41	STA WSVL 35 M 42X2	135,92
42	L	M48X2	22	WSVL 42 M 48X2	182,28	STA WSVL 42 M 48X2	173,11
8	S	M14X1.5	12	WSVS 8 M 14X1.5	14,81	STA WSVS 8 M 14X1.5	13,80
10	S	M16X1.5	12	WSVS 10 M 16X1.5	20,01	STA WSVS 10 M 16X1.5	18,76
12	S	M18X1.5	12	WSVS 12 M 18X1.5	25,09	STA WSVS 12 M 18X1.5	23,78
16	S	M22X1.5	14	WSVS 16 M 22X1.5	28,24	STA WSVS 16 M 22X1.5	26,04
20	S	M27X2	16	WSVS 20 M 27X2	50,03	STA WSVS 20 M 27X2	46,90
25	S	M33X2	18	WSVS 25 M 33X2	87,25	STA WSVS 25 M 33X2	81,94
30	S	M42X2	20	WSVS 30 M 42X2	143,71	STA WSVS 30 M 42X2	135,92
38	S	M48X2	22	WSVS 38 M 48X2	183,09	STA WSVS 38 M 48X2	173,11

## Racor en codo orientable BSP-Métrico

90° Adjustable male stud elbow BSP - Metric

Coude réglable mâle BSP - Métrique

Raccordo a 90° orientabile maschio BSP-Metrico

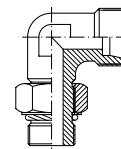

PIPE TUBO	SERIE	THREAD ROSCA		Part n° Referencia	€
6	L	M12X1,5	1/8" BSP	STA WEE 6L R 1/8	6,49
8	L	M14X1,5	1/4" BSP	STA WEE 8L R 1/4	7,38
10	L	M16X1,5	1/4" BSP	STA WEE 10L R 1/4	7,38
12	L	M18X1,5	3/8" BSP	STA WEE 12L R 3/8	9,62
15	L	M22X1,5	1/2" BSP	STA WEE 15L R 1/2	12,69
18	L	M26X1,5	1/2" BSP	STA WEE 18L R 1/2	18,09
22	L	M30X2	3/4" BSP	STA WEE 22L R 3/4	19,74
16	S	M24X1,5	1/2" BSP	STA WEE 16S R 1/2	19,99
20	S	M30X2	3/4" BSP	STA WEE 20S R 3/4	19,74
25	S	M36X2	1" BSP	STA WEE 25S R 1	39,66

# Racores DIN 2353

DIN 2353 Pipe fittings  
Raccords à bague DIN 2353  
Raccordi ad anello DIN 2353

## Tapón de cierre para tubo

Blanking plug with o'ring

Bouchon de fermeture avec o'ring

Tappo di chiusura con o'ring

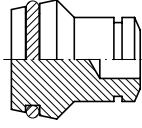

PIPE TUBO	SERIE	Part nº Referencia	€
6	L/S	<b>BUTZEN L 6</b>	<b>0,62</b>
8	L/S	<b>BUTZEN L 8</b>	<b>0,79</b>
10	L/S	<b>BUTZEN L 10</b>	<b>0,94</b>
12	L/S	<b>BUTZEN L 12</b>	<b>0,93</b>
15	L	<b>BUTZEN L 15</b>	<b>1,26</b>
18	L	<b>BUTZEN L 18</b>	<b>1,28</b>
22	L	<b>BUTZEN L 22</b>	<b>1,96</b>
28	L	<b>BUTZEN L 28</b>	<b>2,37</b>
35	L	<b>BUTZEN L 35</b>	<b>4,64</b>
42	L	<b>BUTZEN L 42</b>	<b>6,85</b>
14	S	<b>BUTZEN S 14</b>	<b>1,56</b>
16	S	<b>BUTZEN S 16</b>	<b>1,16</b>
20	S	<b>BUTZEN S 20</b>	<b>1,70</b>
25	S	<b>BUTZEN S 25</b>	<b>2,10</b>
30	S	<b>BUTZEN S 30</b>	<b>3,65</b>
38	S	<b>BUTZEN S 38</b>	<b>6,49</b>

## Tapón macho métrico 24°

24° Metric Plug

Bouchon mâle métrique 24°

Tappo metrico 24°

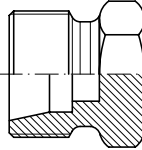

PIPE TUBO	SERIE	THREAD ROSCA	Part nº Referencia	€
6	L	12x1.5	<b>STA TML 6</b>	<b>0,74</b>
8	L	14x1.5	<b>STA TML 8</b>	<b>0,89</b>
10	L	16x1.5	<b>STA TML 10</b>	<b>1,01</b>
12	L	18x1.5	<b>STA TML 12</b>	<b>1,07</b>
15	L	22x1.5	<b>STA TML 15</b>	<b>1,19</b>
18	L	26x1.5	<b>STA TML 18</b>	<b>1,80</b>
22	L	30x2	<b>STA TML 22</b>	<b>2,11</b>
28	L	36x2	<b>STA TML 28</b>	<b>3,47</b>
35	L	45x2	<b>STA TML 35</b>	<b>5,75</b>
42	L	52x2	<b>STA TML 42</b>	<b>29,65</b>
6	S	14x1.5	<b>STA TMS 6</b>	<b>0,99</b>
8	S	16x1.5	<b>STA TMS 8</b>	<b>1,58</b>
10	S	18x1.5	<b>STA TMS 10</b>	<b>1,06</b>
12	S	20x1.5	<b>STA TMS 12</b>	<b>1,31</b>
14	S	22x1.5	<b>STA TMS 14</b>	<b>1,75</b>
16	S	24x1.5	<b>STA TMS 16</b>	<b>1,73</b>
20	S	30x2	<b>STA TMS 20</b>	<b>2,86</b>
25	S	36x2	<b>STA TMS 25</b>	<b>4,66</b>
30	S	42x2	<b>STA TMS 30</b>	<b>7,10</b>
38	S	52x2	<b>STA TMS 38</b>	<b>10,08</b>

## Tapón de cierre Allen rosca BSP con junta

Blanking plug with captive seal BSP cyl

Bouchon Allen gaz avec o'ring

Tappo cilindrico BSP esagono incassato con o'ring

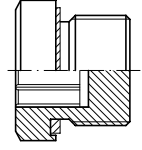

THREAD ROSCA	Part nº Referencia	€
1/8" BSP	<b>STOPFEN 1/8</b>	<b>0,86</b>
1/4" BSP	<b>STOPFEN 1/4</b>	<b>1,03</b>
3/8" BSP	<b>STOPFEN 3/8</b>	<b>1,23</b>
1/2" BSP	<b>STOPFEN 1/2</b>	<b>1,56</b>
3/4" BSP	<b>STOPFEN 3/4</b>	<b>2,11</b>
1" BSP	<b>STOPFEN 1</b>	<b>3,47</b>
1 1/4" BSP	<b>STOPFEN 1 1/4</b>	<b>7,47</b>
1 1/2" BSP	<b>STOPFEN 1 1/2</b>	<b>7,71</b>
2" BSP	<b>STOPFEN 2</b>	<b>19,08</b>

## Tapón de cierre Allen rosca Métrica con junta

Blanking plug with captive seal Metric cyl

Bouchon Allen Métrique avec o'ring

Tappo cilindrico Metrico esagono incassato con guarnizione

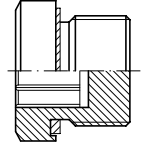

THREAD ROSCA	Part nº Referencia	€
M10X1	<b>STOPFEN M 10X1</b>	<b>0,94</b>
M12X1.25	<b>STOPFEN M 12X1.25</b>	<b>1,19</b>
M12X1.5	<b>STOPFEN M 12X1.5</b>	<b>1,05</b>
M14X1.5	<b>STOPFEN M 14X1.5</b>	<b>1,21</b>
M16X1.5	<b>STOPFEN M 16X1.5</b>	<b>1,28</b>
M18X1.5	<b>STOPFEN M 18X1.5</b>	<b>1,43</b>
M20X1.5	<b>STOPFEN M 20X1.5</b>	<b>2,11</b>
M22X1.5	<b>STOPFEN M 22X1.5</b>	<b>1,50</b>
M26X1.5	<b>STOPFEN M 26X1.5</b>	<b>2,24</b>
M27X2	<b>STOPFEN M 27X2</b>	<b>2,24</b>
M33X2	<b>STOPFEN M 33X2</b>	<b>3,17</b>
M42X2	<b>STOPFEN M 42X2</b>	<b>7,55</b>
M48X2	<b>STOPFEN M 48X2</b>	<b>15,54</b>

# Racores DIN 2353

DIN 2353 Pipe fittings  
Raccords à bague DIN 2353  
Raccordi ad anello DIN 2353

Tubing

Pipe Fittings, DIN 2353  
/ Flare fittings, JIC 37°

SAE Flanges

Tubing Clamps

Machines for  
processing rigid pipes

## Antirretorno tubo-tubo

Non-return valve tube-tube

Clapet antiretour bidirectional tube-tube

Valvola di ritegno tubo-tubo

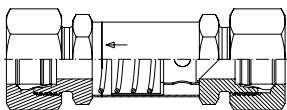

PIPE TUBO	SERIE	Part n° Referencia	€	Part N° STA Referencia STA	€
6	L	RHDL 6	22,91	STA RHDL 6	21,07
8	L	RHDL 8	23,83	STA RHDL 8	22,03
10	L	RHDL 10	28,28	STA RHDL 10	26,12
12	L	RHDL 12	34,04	STA RHDL 12	31,66
15	L	RHDL 15	38,41	STA RHDL 15	35,27
18	L	RHDL 18	54,10	STA RHDL 18	49,72
22	L	RHDL 22	76,28	STA RHDL 22	70,42
28	L	RHDL 28	131,78	STA RHDL 28	123,38
35	L	RHDL 35	193,54	STA RHDL 35	180,56
42	L	RHDL 42	480,30	STA RHDL 42	461,96
6	S	RHDS 6	23,23	STA RHDS 6	21,31
8	S	RHDS 8	23,33	STA RHDS 8	21,31
10	S	RHDS 10	28,74	STA RHDS 10	26,24
12	S	RHDS 12	33,32	STA RHDS 12	30,70
14	S	RHDS 14	40,23	STA RHDS 14	36,11
16	S	RHDS 16	50,14	STA RHDS 16	45,74
20	S	RHDS 20	63,80	STA RHDS 20	57,54
25	S	RHDS 25	98,49	STA RHDS 25	87,87
30	S	RHDS 30	186,15	STA RHDS 30	170,57
38	S	RHDS 38	*	STA RHDS 38	*

Taraje 1 bar. Para otras presiones de tarado estandard, consultar. / Setting 1 bar. For other standard spring pressures, consult us. / Tarage 1 bar. Pour d'autres pressions ressort standard, consultez-nous. / Per altre pressioni di taratura standard, consultare.

## Antirretorno tubo - rosca BSP

Non-return valve flow towards male stud end  
BSP cyl

Clapet antiretour unidir. à droite tube-mâle BSP

Valvola di ritegno a destra

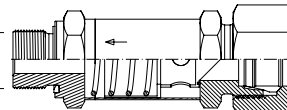

T.	S.	THREAD ROSCA	Part n° Referencia	€	Part N° STA Referencia STA	€
6	L	1/8" BSP	RHZL 6 R 1/8	23,27	STA RHZL 6 R 1/8	21,43
8	L	1/4" BSP	RHZL 8 R 1/4	25,03	STA RHZL 8 R 1/4	23,23
10	L	1/4" BSP	RHZL 10 R 1/4	29,24	STA RHZL 10 R 1/4	27,08
12	L	3/8" BSP	RHZL 12 R 3/8	34,52	STA RHZL 12 R 3/8	32,14
15	L	1/2" BSP	RHZL 15 R 1/2	38,89	STA RHZL 15 R 1/2	35,75
18	L	1/2" BSP	RHZL 18 R 1/2	54,58	STA RHZL 18 R 1/2	50,20
22	L	3/4" BSP	RHZL 22 R 3/4	86,75	STA RHZL 22 R 3/4	80,89
28	L	1" BSP	RHZL 28 R 1	100,84	STA RHZL 28 R 1	92,44
35	L	1"1/4 BSP	RHZL 35 R 1 1/4	*	STA RHZL 35 R 1 1/4	*
42	L	1"1/2 BSP	RHZL 42 R 1 1/2	*	STA RHZL 42 R 1 1/2	*
6	S	1/4" BSP	RHZS 6 R 1/4	23,59	STA RHZS 6 R 1/4	21,67
8	S	1/4" BSP	RHZS 8 R 1/4	23,69	STA RHZS 8 R 1/4	21,67
10	S	3/8" BSP	RHZS 10 R 3/8	29,34	STA RHZS 10 R 3/8	26,84
12	S	3/8" BSP	RHZS 12 R 3/8	34,28	STA RHZS 12 R 3/8	31,66
14	S	1/2" BSP	RHZS 14 R 1/2	40,47	STA RHZS 14 R 1/2	36,35
16	S	1/2" BSP	RHZS 16 R 1/2	52,31	STA RHZS 16 R 1/2	47,91
20	S	3/4" BSP	RHZS 20 R 3/4	64,88	STA RHZS 20 R 3/4	58,62
25	S	1" BSP	RHZS 25 R 1	99,10	STA RHZS 25 R 1	88,48
30	S	1"1/4 BSP	RHZS 30 R 1 1/4	*	STA RHZS 30 R 1 1/4	*
38	S	1"1/2 BSP	RHZS 38 R 1 1/2	*	STA RHZS 38 R 1 1/2	*

Taraje 1 bar. Para otras presiones de tarado estandard, consultar. / Setting 1 bar. For other standard spring pressures, consult us. / Tarage 1 bar. Pour d'autres pressions ressort standard, consultez-nous. / Per altre pressioni di taratura standard, consultare.

## Antirretorno rosca BSP - tubo

Non-return valve flow from male stud end BSP cyl

Clapet antiretour unidir. à gauche mâle BSP-tube

Valvola di ritegno a sinistra

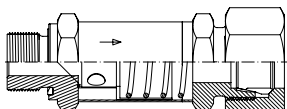

T.	S.	THREAD ROSCA	Part n° Referencia	€	Part N° STA Referencia STA	€
6	L	1/8" BSP	RHVL 6 R 1/8	23,15	STA RHVL 6 R 1/8	21,31
8	L	1/4" BSP	RHVL 8 R 1/4	25,51	STA RHVL 8 R 1/4	23,71
10	L	1/4" BSP	RHVL 10 R 1/4	29,24	STA RHVL 10 R 1/4	27,08
12	L	3/8" BSP	RHVL 12 R 3/8	35,48	STA RHVL 12 R 3/8	33,10
15	L	1/2" BSP	RHVL 15 R 1/2	40,22	STA RHVL 15 R 1/2	37,08
18	L	1/2" BSP	RHVL 18 R 1/2	56,50	STA RHVL 18 R 1/2	52,12
22	L	3/4" BSP	RHVL 22 R 3/4	84,10	STA RHVL 22 R 3/4	78,24
28	L	1" BSP	RHVL 28 R 1	97,89	STA RHVL 28 R 1	89,49
35	L	1"1/4 BSP	RHVL 35 R 1 1/4	258,47	STA RHVL 35 R 1 1/4	245,49
42	L	1"1/2 BSP	RHVL 42 R 1 1/2	265,36	STA RHVL 42 R 1 1/2	247,02
6	S	1/4" BSP	RHVS 6 R 1/4	26,00	STA RHVS 6 R 1/4	24,08
8	S	1/4" BSP	RHVS 8 R 1/4	26,10	STA RHVS 8 R 1/4	24,08
10	S	3/8" BSP	RHVS 10 R 3/8	29,34	STA RHVS 10 R 3/8	26,84
12	S	3/8" BSP	RHVS 12 R 3/8	34,76	STA RHVS 12 R 3/8	32,14
14	S	1/2" BSP	RHVS 14 R 1/2	41,80	STA RHVS 14 R 1/2	37,68
16	S	1/2" BSP	RHVS 16 R 1/2	51,59	STA RHVS 16 R 1/2	47,19
20	S	3/4" BSP	RHVS 20 R 3/4	65,48	STA RHVS 20 R 3/4	59,22
25	S	1" BSP	RHVS 25 R 1	99,94	STA RHVS 25 R 1	89,32
30	S	1"1/4 BSP	RHVS 30 R 1 1/4	*	STA RHVS 30 R 1 1/4	*
38	S	1"1/2 BSP	RHVS 38 R 1 1/2	*	STA RHVS 38 R 1 1/2	*

Taraje 1 bar. Para otras presiones de tarado estandard, consultar. / Setting 1 bar. For other standard spring pressures, consult us. / Tarage 1 bar. Pour d'autres pressions ressort standard, consultez-nous. / Per altre pressioni di taratura standard, consultare.

Mejoramos precios de la  
**válvula antirretorno tubo-tubo**  
**Non-return valve tube-tube**  
improved price

# Racores JIC 37°

JIC 37° fittings  
Raccords JIC 37°  
Raccordi JIC 37°

T/Male Pipe

Pipe Fittings, DIN 2353  
/ Flare fittings, JIC 37°

SAE Flanges

T/Male Clamps

Machines for  
processing rigid pipes

## Tuercas JIC 37°

JIC 37° Nuts

Écrous JIC 37°

Dado JIC 37°

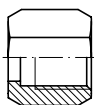

PIPE TUBO		THREAD ROSCA	Part n° Referencia	€
6	1/4	7/16" 20h UNF	<b>S11006</b>	<b>0,55</b>
8	5/16	1/2" 20h UNF	<b>S11008</b>	<b>0,64</b>
10	3/8	9/16" 18h UNF	<b>S11010</b>	<b>0,70</b>
12	1/2	3/4" 16h UNF	<b>S11012</b>	<b>0,86</b>
14-15-16	5/8	7/8" 14h UNF	<b>S11016</b>	<b>1,47</b>
18-20	-	1"1/16 12h UNF	<b>S11020</b>	<b>2,60</b>
-	3/4	1"1/16 12h UNF	<b>S11020W</b>	<b>3,21</b>
25	1	1"5/16 12h UNF	<b>S11025</b>	<b>4,01</b>
30-32	1 1/4	1"5/8 12h UNF	<b>S11032</b>	<b>7,71</b>
38	1 1/2	1"7/8 12h UNF	<b>S11038</b>	<b>9,54</b>
50	2	2" 1/2 12h UNF	<b>S11050</b>	<b>14,73</b>

## Férulas JIC 37° (Tubo Métrico)

JIC 37° sleeves Metric tube

Férules JIC 37° pour tube Métrique

Bussola JIC 37° (tubo Metrico)

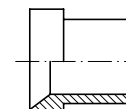

PIPE TUBO		Part n° Referencia	€
6		<b>S12006</b>	<b>0,50</b>
8		<b>S12008</b>	<b>0,54</b>
10		<b>S12010</b>	<b>0,49</b>
12		<b>S12012</b>	<b>0,57</b>
14		<b>S12014</b>	<b>0,98</b>
15		<b>S12015</b>	<b>0,96</b>
16		<b>S12016</b>	<b>0,80</b>
18		<b>S12018</b>	<b>1,36</b>
20		<b>S12020</b>	<b>1,36</b>
25		<b>S12025</b>	<b>2,07</b>
30		<b>S12030</b>	<b>5,30</b>
32		<b>S12032</b>	<b>4,53</b>
38		<b>S12038</b>	<b>7,42</b>

## Tapón hembra JIC 37°

37° JIC Cap

Obtuteur femelle JIC 37° pour raccord

Tappo femmina girevole JIC 37°

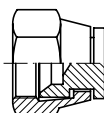

PIPE TUBO		THREAD ROSCA	Part n° Referencia	€
6	1/4	7/16" 20h UNF	<b>S13006</b>	<b>1,55</b>
8	5/16	1/2" 20h UNF	<b>S13008</b>	<b>2,05</b>
10	3/8	9/16" 18h UNF	<b>S13010</b>	<b>2,32</b>
12	1/2	3/4" 16h UNF	<b>S13012</b>	<b>2,66</b>
14-15-16	5/8	7/8" 14h UNF	<b>S13016</b>	<b>3,70</b>
18-20	3/4	1"1/16 12h UNF	<b>S13020</b>	<b>5,42</b>
25	1	1"5/16 12h UNF	<b>S13025</b>	<b>9,29</b>
30-32	1 1/4	1"5/8 12h UNF	<b>S13032</b>	<b>15,74</b>
38	1 1/2	1"7/8 12h UNF	<b>S13038</b>	<b>30,79</b>

## Tapón macho JIC 37°

37° JIC Male plug

Bouchon mâle JIC 37°

Tappo maschio JIC 37°

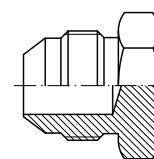

PIPE TUBO		THREAD ROSCA	Part n° Referencia	€
6	1/4	7/16" 20h UNF	<b>S14006</b>	<b>1,27</b>
8	5/16	1/2" 20h UNF	<b>S14008</b>	<b>1,55</b>
10	3/8	9/16" 18h UNF	<b>S14010</b>	<b>1,50</b>
12	1/2	3/4" 16h UNF	<b>S14012</b>	<b>1,56</b>
14-15-16	5/8	7/8" 14h UNF	<b>S14016</b>	<b>1,85</b>
18-20	3/4	1"1/16 12h UNF	<b>S14020</b>	<b>3,37</b>
25	1	1"5/16 12h UNF	<b>S14025</b>	<b>4,73</b>
30-32	1 1/4	1"5/8 12h UNF	<b>S14032</b>	<b>8,17</b>
38	1 1/2	1"7/8 12h UNF	<b>S14038</b>	<b>28,07</b>

## Racor macho-macho JIC 37°

Straight union JIC 37°

Adapteur droit mâle JIC x mâle JIC

Niples di giunzione maschio-maschio JIC 37°

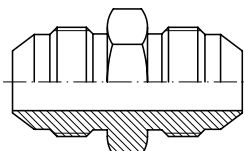

PIPE TUBO		THREAD ROSCA	Part n° Referencia	€
6	1/4	7/16" 20h UNF	<b>S26006</b>	<b>1,33</b>
8	5/16	1/2" 20h UNF	<b>S26008</b>	<b>1,40</b>
10	3/8	9/16" 18h UNF	<b>S26010</b>	<b>1,45</b>
12	1/2	3/4" 16h UNF	<b>S26012</b>	<b>1,60</b>
14-15-16	5/8	7/8" 14h UNF	<b>S26016</b>	<b>2,49</b>
18-20	3/4	1"1/16 12h UNF	<b>S26020</b>	<b>3,80</b>
25	1	1"5/16 12h UNF	<b>S26025</b>	<b>6,10</b>
30-32	1 1/4	1"5/8 12h UNF	<b>S26032</b>	<b>10,86</b>
38	1 1/2	1"7/8 12h UNF	<b>S26038</b>	<b>18,74</b>

## Racor hembra giratoria-hembra giratoria JIC 37°

Straight swivel female JIC 37°

Adapteur femelle tournante JIC x femelle tournante JIC 37°

Niples femmina-femmina girevole JIC 37°

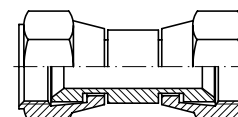

PIPE TUBO		THREAD ROSCA	Part n° Referencia	€
6	1/4	7/16" 20h UNF	<b>S73006</b>	<b>4,24</b>
8	5/16	1/2" 20h UNF	<b>S73008</b>	<b>7,25</b>
10	3/8	9/16" 18h UNF	<b>S73010</b>	<b>5,43</b>
12	1/2	3/4" 16h UNF	<b>S73012</b>	<b>9,90</b>
14-15-16	5/8	7/8" 14h UNF	<b>S73016</b>	<b>11,27</b>
18-20	3/4	1"1/16 12h UNF	<b>S73020</b>	<b>11,59</b>
25	1	1"5/16 12h UNF	<b>S73025</b>	<b>18,15</b>

# Racores JIC 37°

JIC 37° fittings

Raccords JIC 37°

Raccordi JIC 37°

## Racor macho JIC 37° - macho NPT

Straight adaptor male JIC-male NPT

Adapteur mâle JIC x mâle NPT

Niples di giunzione JIC 37°-NPT

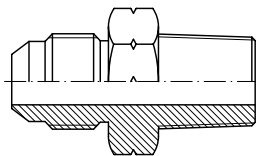

PIPE TUBO		THREAD ROSCA		Part n° Referencia	€
6	1/4	1/8" NPT	7/16" 20h UNF	<b>S2000610</b>	<b>1,43</b>
6	1/4	1/4" NPT	7/16" 20h UNF	<b>S2000613</b>	<b>1,49</b>
8	5/16	1/8" NPT	1/2" 20h UNF	<b>S2000810</b>	<b>2,31</b>
8	5/16	1/4" NPT	1/2" 20h UNF	<b>S2000813</b>	<b>1,76</b>
10	3/8	1/4" NPT	9/16" 18h UNF	<b>S2001013</b>	<b>1,78</b>
10	3/8	3/8" NPT	9/16" 18h UNF	<b>S2001017</b>	<b>1,95</b>
10	3/8	1/2" NPT	9/16" 18h UNF	<b>S2001021</b>	<b>2,71</b>
12	1/2	3/8" NPT	3/4" 16h UNF	<b>S2001217</b>	<b>2,76</b>
12	1/2	1/2" NPT	3/4" 16h UNF	<b>S2001221</b>	<b>3,01</b>
12	1/2	3/4" NPT	3/4" 16h UNF	<b>S2001226</b>	<b>3,59</b>
14-15-16	5/8	1/2" NPT	7/8" 14h UNF	<b>S2001621</b>	<b>4,01</b>
14-15-16	5/8	3/4" NPT	7/8" 14h UNF	<b>S2001626</b>	<b>5,18</b>
18-20	3/4	1/2" NPT	1"1/16 12h UNF	<b>S2002021</b>	<b>4,54</b>
18-20	3/4	3/4" NPT	1"1/16 12h UNF	<b>S2002026</b>	<b>5,12</b>
18-20	3/4	1" NPT	1"1/16 12h UNF	<b>S2002033</b>	<b>6,62</b>
25	1	3/4" NPT	1"5/16 12h UNF	<b>S2002526</b>	<b>7,79</b>
25	1	1" NPT	1"5/16 12h UNF	<b>S2002533</b>	<b>7,53</b>
32	1 1/4	1" NPT	1"5/8 12h UNF	<b>S2003233</b>	<b>22,01</b>
32	1 1/4	1"1/4 NPT	1"5/8 12h UNF	<b>S2003242</b>	<b>15,66</b>
38	1 1/2	1"1/4 NPT	1"7/8 12h UNF	<b>S2003842</b>	<b>32,55</b>
38	1 1/2	1"1/2 NPT	1"7/8 12h UNF	<b>S2003848</b>	<b>28,56</b>

## Racor macho JIC 37° - macho BSP

Straight adaptor male JIC-male BSP

Adapteur mâle JIC x mâle gaz cyl équipé

Niples di giunzione JIC 37°-BSP

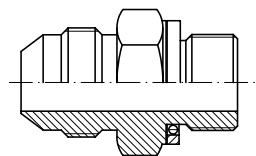

PIPE TUBO		THREAD ROSCA		Part n° Referencia	€
6	1/4	7/16" 20h UNF	1/8" BSP	<b>S2300610</b>	<b>1,36</b>
6	1/4	7/16" 20h UNF	1/4" BSP	<b>S2300613</b>	<b>1,79</b>
6	1/4	7/16" 20h UNF	3/8" BSP	<b>S2300617</b>	<b>1,93</b>
8	5/16	1/2" 20h UNF	1/4" BSP	<b>S2300813</b>	<b>2,02</b>
8	5/16	1/2" 20h UNF	3/8" BSP	<b>S2300817</b>	<b>2,16</b>
10	3/8	9/16" 18h UNF	1/4" BSP	<b>S2301013</b>	<b>1,73</b>
10	3/8	9/16" 18h UNF	3/8" BSP	<b>S2301017</b>	<b>2,00</b>
10	3/8	9/16" 18h UNF	1/2" BSP	<b>S2301021</b>	<b>3,65</b>
12	1/2	3/4" 16h UNF	1/4" BSP	<b>S2301213</b>	<b>1,87</b>
12	1/2	3/4" 16h UNF	3/8" BSP	<b>S2301217</b>	<b>1,93</b>
12	1/2	3/4" 16h UNF	1/2" BSP	<b>S2301221</b>	<b>3,20</b>
12	1/2	3/4" 16h UNF	3/4" BSP	<b>S2301226</b>	<b>4,32</b>
14-15-16	5/8	7/8" 14h UNF	3/8" BSP	<b>S2301617</b>	<b>2,39</b>
14-15-16	5/8	7/8" 14h UNF	1/2" BSP	<b>S2301621</b>	<b>3,06</b>
14-15-16	5/8	7/8" 14h UNF	3/4" BSP	<b>S2301626</b>	<b>4,99</b>
18-20	3/4	1"1/16 12h UNF	1/2" BSP	<b>S2302021</b>	<b>4,09</b>
18-20	3/4	1"1/16 12h UNF	3/4" BSP	<b>S2302026</b>	<b>5,65</b>
18-20	3/4	1"1/16 12h UNF	1" BSP	<b>S2302033</b>	<b>7,81</b>
25	1	1"5/16 12h UNF	3/4" BSP	<b>S2302526</b>	<b>6,55</b>
25	1	1"5/16 12h UNF	1" BSP	<b>S2302533</b>	<b>7,89</b>
25	1	1"5/16 12h UNF	1"1/4 BSP	<b>S2302542</b>	<b>11,31</b>
30-32	1 1/4	1"5/8 12h UNF	1"1/4 BSP	<b>S2303242</b>	<b>12,28</b>
38	1 1/2	1"7/8 12h UNF	1"1/4 BSP	<b>S2303842</b>	<b>14,78</b>
38	1 1/2	1"7/8 12h UNF	1"1/2 BSP	<b>S2303848</b>	<b>25,00</b>

## Racor macho JIC 37° - macho BSPT

Straight adaptor male JIC-male BSPT

Adapteur mâle JIC x mâle gaz conique

Niples di giunzione JIC 37°-BSPT

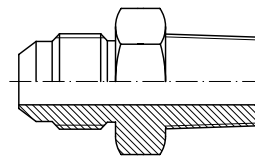

PIPE TUBO		THREAD ROSCA		Part n° Referencia	€
6	1/4	1/8" BSPT	7/16" 20h UNF	<b>S2100610</b>	<b>0,93</b>
6	1/4	1/4" BSPT	7/16" 20h UNF	<b>S2100613</b>	<b>1,43</b>
8	5/16	1/8" BSPT	1/2" 20h UNF	<b>S2100810</b>	<b>1,15</b>
8	5/16	1/4" BSPT	1/2" 20h UNF	<b>S2100813</b>	<b>1,24</b>
10	3/8	1/4" BSPT	9/16" 18h UNF	<b>S2101013</b>	<b>1,53</b>
10	3/8	3/8" BSPT	9/16" 18h UNF	<b>S2101017</b>	<b>1,66</b>
10	3/8	1/2" BSPT	9/16" 18h UNF	<b>S2101021</b>	<b>2,65</b>
12	1/2	1/4" BSPT	3/4" 16h UNF	<b>S2101213</b>	<b>1,88</b>
12	1/2	3/8" BSPT	3/4" 16h UNF	<b>S2101217</b>	<b>2,23</b>
12	1/2	1/2" BSPT	3/4" 16h UNF	<b>S2101221</b>	<b>2,83</b>
14-15-16	5/8	3/8" BSPT	7/8" 14h UNF	<b>S2101617</b>	<b>3,17</b>
14-15-16	5/8	1/2" BSPT	7/8" 14h UNF	<b>S2101621</b>	<b>2,99</b>
14-15-16	5/8	3/4" BSPT	7/8" 14h UNF	<b>S2101626</b>	<b>3,14</b>
18-20	3/4	1/2" BSPT	1"1/16 12h UNF	<b>S2102021</b>	<b>3,64</b>
18-20	3/4	3/4" BSPT	1"1/16 12h UNF	<b>S2102026</b>	<b>4,39</b>
25	1	3/4" BSPT	1"5/16 12h UNF	<b>S2102526</b>	<b>6,79</b>
25	1	1" BSPT	1"5/16 12h UNF	<b>S2102533</b>	<b>6,39</b>
30-32	1 1/4	1" BSPT	1"5/8 12h UNF	<b>S2103233</b>	<b>21,59</b>
30-32	1 1/4	1"1/4 BSPT	1"5/8 12h UNF	<b>S2103242</b>	<b>20,45</b>
38	1 1/2	1"1/2 BSPT	1"7/8 12h UNF	<b>S2103848</b>	<b>28,31</b>

## Racor macho JIC 37° - macho UNF

Straight adaptor male JIC-male UNF

Adapteur mâle JIC x mâle UNF équipé

Niples di giunzione JIC 37°-UNF

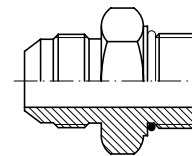

PIPE TUBO		THREAD ROSCA		Part n° Referencia	€
6	1/4	7/16" 20h JIC	7/16" 20h UNF	<b>S2200611</b>	<b>1,20</b>
6	1/4	7/16" 20h JIC	1/2" 20h UNF	<b>S2200612</b>	<b>1,55</b>
6	1/4	7/16" 20h JIC	9/16" 18h UNF	<b>S2200614</b>	<b>1,49</b>
8	5/16	1/2" 20h JIC	1/2" 20h UNF	<b>S2200812</b>	<b>1,45</b>
10	3/8	9/16" 18h JIC	9/16" 18h UNF	<b>S2201014</b>	<b>1,71</b>
10	3/8	9/16" 18h JIC	3/4" 16h UNF	<b>S2201019</b>	<b>2,01</b>
12	1/2	3/4" 16h JIC	3/4" 16h UNF	<b>S2201219</b>	<b>2,65</b>
12	1/2	3/4" 16h JIC	7/8" 14h UNF	<b>S2201222</b>	<b>3,77</b>
14-15-16	5/8	7/8" 14h JIC	7/8" 14h UNF	<b>S2201622</b>	<b>3,36</b>
14-15-16	5/8	7/8" 14h JIC	1"1/16 12h UNF	<b>S2201627</b>	<b>5,69</b>
14-15-16	5/8	7/8" 14h JIC	3/4" 16h UNF	<b>S2201619</b>	<b>3,42</b>
18-20	3/4	1"1/16 12h JIC	3/4" 16h UNF	<b>S2202019</b>	<b>4,76</b>
18-20	3/4	1"1/16 12h JIC	7/8" 14h UNF	<b>S2202022</b>	<b>4,54</b>
18-20	3/4	1"1/16 12h JIC	1"1/16 12h UNF	<b>S2202027</b>	<b>5,61</b>
18-20	3/4	1"1/16 12h JIC	1"5/16 12h UNF	<b>S2202033</b>	<b>6,21</b>
25	1	1"5/16 12h JIC	1"1/16 12h UNF	<b>S2202527</b>	<b>9,91</b>
25	1	1"5/16 12h JIC	1"5/16 12h UNF	<b>S2202533</b>	<b>6,18</b>
25	1	1"5/16 12h JIC	1"5/8 12h UNF	<b>S2202541</b>	<b>27,23</b>
30-32	1 1/4	1"5/8 12h JIC	1"5/8 12h UNF	<b>S2203241</b>	<b>12,56</b>
38	1 1/2	1"7/8 12h JIC	1"7/8 12h UNF	<b>S2203848</b>	<b>33,36</b>

# Racores JIC 37°

JIC 37° fittings  
Raccords JIC 37°  
Raccordi JIC 37°

T/Ale pipe

Pipe Fittings, DIN 2353 / Flare fittings, JIC 37°

SAE Flanges

T/Ale clamps

Machines for processing rigid pipes

## Racor pasatabiques JIC 37°

Straight bulkhead fitting JIC 37°

Union passe cloison droite mâle JIC x mâle JIC équipé

Niples passaparete JIC 37°

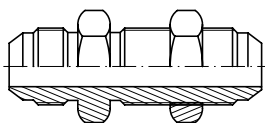

PIPE TUBO		THREAD ROSCA	Part nº Referencia	€
6	1/4	7/16" 20h UNF	<b>S25006</b>	<b>2,56</b>
8	5/16	1/2" 20h UNF	<b>S25008</b>	<b>3,42</b>
10	3/8	9/16" 18h UNF	<b>S25010</b>	<b>3,50</b>
12	1/2	3/4" 16h UNF	<b>S25012</b>	<b>4,59</b>
14-15-16	5/8	7/8" 14h UNF	<b>S25016</b>	<b>5,12</b>
18-20	3/4	1"1/16 12h UNF	<b>S25020</b>	<b>8,67</b>
25	1	1"5/16 12h UNF	<b>S25025</b>	<b>10,10</b>
30-32	1 1/4	1"5/8 12h UNF	<b>S25032</b>	<b>19,87</b>
38	1 1/2	1"7/8 12h UNF	<b>S25038</b>	<b>48,73</b>

## Racor macho JIC 37° - macho Métrico

Metric adaptor male-male JIC 37°

Adapteur mâle JIC x mâle Métrique équipé

Niples di giunzione JIC 37°-Metrico

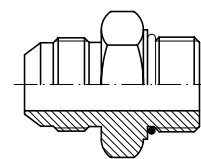

PIPE TUBO		THREAD ROSCA	Part nº Referencia	€	
6	1/4	7/16" 20h UNF	M10X1	<b>S2400610</b>	<b>2,97</b>
8	5/16	1/2" 20h UNF	M12X1.5	<b>S2400812</b>	<b>3,13</b>
10	3/8	9/16" 18h UNF	M14X1.5	<b>S2401014</b>	<b>3,40</b>
12	1/2	3/4" 16h UNF	M16X1.5	<b>S2401216</b>	<b>3,36</b>
12	1/2	3/4" 16h UNF	M18X1.5	<b>S2401218</b>	<b>3,80</b>
14-15-16	5/8	7/8" 14h UNF	M18X1.5	<b>S2401418</b>	<b>4,53</b>
14-15-16	5/8	7/8" 14h UNF	M22X1.5	<b>S2401622</b>	<b>4,95</b>
20	3/4	1"1/16 12h UNF	M18X1.5	<b>S2402018</b>	<b>7,71</b>
18-20	3/4	1"1/16 12h UNF	M22X1.5	<b>S2402022</b>	<b>7,74</b>
18-20	3/4	1"1/16 12h UNF	M27X2	<b>S2402027</b>	<b>10,09</b>
25	1	1"5/16 12h UNF	M33X2	<b>S2402533</b>	<b>19,00</b>
30-32	1 1/4	1"5/8 12h UNF	M42X2	<b>S2403242</b>	<b>31,36</b>

## Racor macho BSP - hembra giratoria JIC 37°

Adaptor swivel female JIC-male BSP

Adapteur femelle tournante JIC x mâle gaz cyl équipé

Niples maschio-femmina BSP-JIC 37°

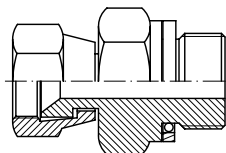

PIPE TUBO		THREAD ROSCA	Part nº Referencia	€	
6	1/4	M 1/8" BSP	F 7/16" 20F UNF	<b>S1800610</b>	<b>3,70</b>
8	5/16	M 1/4" BSP	F 1/2" 20F UNF	<b>S1800813</b>	<b>4,64</b>
8	5/16	M 3/8" BSP	F 1/2" 20F UNF	<b>S1800817</b>	<b>5,12</b>
10	3/8	M 1/4" BSP	F 9/16" 18F UNF	<b>S1801013</b>	<b>5,59</b>
10	3/8	M 3/8" BSP	F 9/16" 18F UNF	<b>S1801017</b>	<b>6,88</b>
12	1/2	M 3/8" BSP	F 3/4" 16F UNF	<b>S1801217</b>	<b>7,31</b>
14-15-16	5/8	M 1/2" BSP	F 7/8" 14F UNF	<b>S1801621</b>	<b>9,89</b>
18-20	3/4	M 3/4" BSP	F 1"1/16 12F UNF	<b>S1802026</b>	<b>11,44</b>
25	1	M 1" BSP	F 1"5/16 12F UNF	<b>S1802533</b>	<b>16,50</b>
30-32	1 1/4	M 1"1/4 BSP	F 1"5/8 12F UNF	<b>S1803242</b>	<b>28,47</b>
38	1 1/2	M 1"1/2 BSP	F 1"7/8 12F UNF	<b>S1803848</b>	<b>69,70</b>

## Racor macho JIC 37° - hembra fija BSP

Adaptor male JIC 37°-fixed female BSP

Adapteur mâle JIC x femelle gaz cyl

Niples maschio-femmina JIC 37°-BSP

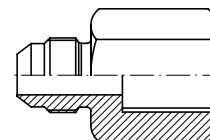

PIPE TUBO		THREAD ROSCA	Part nº Referencia	€	
6	1/4	M 7/16" 20h UNF	F 1/8" BSP	<b>S2800610</b>	<b>5,40</b>
6	1/4	M 7/16" 20h UNF	F 1/4" BSP	<b>S2800613</b>	<b>5,40</b>
8	5/16	M 1/2" 20h UNF	F 1/8" BSP	<b>S2800810</b>	<b>6,01</b>
8	5/16	M 1/2" 20h UNF	F 1/4" BSP	<b>S2800813</b>	<b>6,01</b>
10	3/8	M 9/16" 18h UNF	F 1/4" BSP	<b>S2801013</b>	<b>5,55</b>
10	3/8	M 9/16" 18h UNF	F 3/8" BSP	<b>S2801017</b>	<b>6,01</b>
12	1/2	M 3/4" 16h UNF	F 3/8" BSP	<b>S2801217</b>	<b>6,01</b>
12	1/2	M 3/4" 16h UNF	F 1/2" BSP	<b>S2801221</b>	<b>7,42</b>
14-15-16	5/8	M 7/8" 14h UNF	F 1/2" BSP	<b>S2801621</b>	<b>7,27</b>
18-20	3/4	M 1"1/16 12h UNF	F 1/2" BSP	<b>S2802021</b>	<b>9,93</b>
18-20	3/4	M 1"1/16 12h UNF	F 3/4" BSP	<b>S2802026</b>	<b>10,05</b>
25	1	M 1"5/16 12h UNF	F 1" BSP	<b>S2802533</b>	<b>19,25</b>
30-32	1 1/4	M 1"5/8 12h UNF	F 1"1/4 BSP	<b>S2803242</b>	<b>30,02</b>
38	1 1/2	M 1"7/8 12h UNF	F 1"1/2 BSP	<b>S2803848</b>	<b>48,09</b>

## Racor unión macho-hembra fija JIC 37°

Reducer adaptor JIC male-JIC 37° fixed female

Reducteur mâle JIC x femelle fixe JIC 37°

Riduzione maschio-femmina fissa JIC 37°

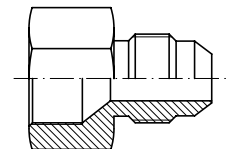

T.	THREAD ROSCA		Part nº Referencia	€	
10	6	F 7/16" 18F UNF	M 9/16" 20h UNF	<b>S2900610</b>	<b>2,62</b>
10	6	F 9/16" 18F UNF	M 7/16" 20h UNF	<b>S2901006</b>	<b>5,25</b>
12	6	F 3/4" 16F UNF	M 7/16" 20h UNF	<b>S2901206</b>	<b>5,48</b>
8	12	F 3/4" 16F UNF	M 1/2" 20h UNF	<b>S2901208</b>	<b>6,87</b>
12	10	F 3/4" 16F UNF	M 9/16" 18h UNF	<b>S2901210</b>	<b>5,31</b>
14-15-16	6	F 7/8" 14F UNF	M 7/16" 20h UNF	<b>S2901606</b>	<b>7,66</b>
14-15-16	10	F 7/8" 14F UNF	M 9/16" 18h UNF	<b>S2901610</b>	<b>8,38</b>
14-15-16	12	F 7/8" 14F UNF	M 3/4" 16h UNF	<b>S2901612</b>	<b>6,53</b>
18-20	6	F 1"1/16 12F UNF	M 7/16" 20h UNF	<b>S2902006</b>	<b>8,90</b>
18-20	12	F 1"1/16 12F UNF	M 3/4" 16h UNF	<b>S2902012</b>	<b>8,38</b>
25	18-20	F 1"5/16 12F UNF	M 1"1/16 12h UNF	<b>S2902520</b>	<b>11,17</b>
30-32	25	F 1"5/8 12F UNF	M 1"5/16 12h UNF	<b>S2903225</b>	<b>20,62</b>
38	30-32	F 1"7/8 12F UNF	M 1"5/8 12h UNF	<b>S2903832</b>	<b>27,51</b>

## Racor macho BSPT - hembra giratoria JIC 37°

Adaptor male BSPT-swivel female JIC 37°

Adapteur femelle tournante JIC x mâle gaz conique

Niples maschio-femmina BSPT-JIC 37°

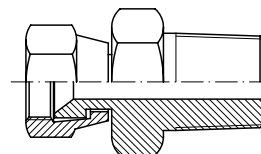

PIPE TUBO		THREAD ROSCA	Part nº Referencia	€	
6	1/4	M 1/4" BSPT	F 7/16" 20h UNF	<b>S1500613</b>	<b>6,03</b>
8	5/16	M 1/4" BSPT	F 1/2" 20h UNF	<b>S1500813</b>	<b>7,00</b>
10	3/8	M 1/4" BSPT	F 9/16" 18h UNF	<b>S1501013</b>	<b>7,04</b>
12	1/2	M 1/4" BSPT	F 3/4" 16h UNF	<b>S1501213</b>	<b>8,68</b>
12	1/2	M 3/8" BSPT	F 3/4" 16h UNF	<b>S1501217</b>	<b>8,21</b>
16	5/8	M 1/2" BSPT	F 7/8" 14h UNF	<b>S1501621</b>	<b>11,77</b>
20	3/4	M 1/2" BSPT	F 1"1/16 12h UNF	<b>S1502021</b>	<b>13,31</b>
20	3/4	M 3/4" BSPT	F 1"1/16 12h UNF	<b>S1502026</b>	<b>13,61</b>
25	1	M 3/4" BSPT	F 1"5/16 12h UNF	<b>S1502526</b>	<b>27,33</b>
25	1	M 1" BSPT	F 1"5/16 12h UNF	<b>S1502533</b>	<b>26,18</b>
32	1 1/4	M 1"1/4 BSPT	F 1"5/8 12h UNF	<b>S1503242</b>	<b>39,76</b>

# Racores JIC 37°

JIC 37° fittings

Raccords JIC 37°

Raccordi JIC 37°

## Adaptador hembra giratoria JIC - Macho BSP (60°)

Adaptor swivel female JIC 37° - BSP male 60°

Adapteur femelle tournante JIC x mâle BSP 60°

Nipples femmina girevole JIC 37° - maschio BSP 60°

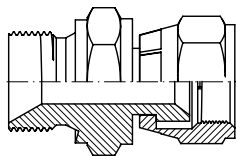

THREAD ROSCA		Part n° Referencia	€
M 1/4" BSP	F 7/16" UNF	<b>S2150604</b>	<b>3,35</b>
M 1/4" BSP	F 1/2" UNF	<b>S2150804</b>	<b>3,60</b>
M 1/4" BSP	F 9/16" UNF	<b>S2151004</b>	<b>3,75</b>
M 3/8" BSP	F 9/16" UNF	<b>S2151006</b>	<b>4,37</b>
M 1/2" BSP	F 9/16" UNF	<b>S2151008</b>	<b>5,32</b>
M 3/8" BSP	F 3/4" UNF	<b>S2151206</b>	<b>4,57</b>
M 1/2" BSP	F 3/4" UNF	<b>S2151208</b>	<b>5,58</b>
M 1/2" BSP	F 7/8" UNF	<b>S2151608</b>	<b>5,88</b>
M 3/4" BSP	F 1" 1/16 UNF	<b>S2152012</b>	<b>7,57</b>
M 1" BSP	F 1"5/16 UNF	<b>S2152516</b>	<b>13,32</b>

## Adaptador Macho JIC - hembra giratoria JIC 37°

Adaptor male JIC - swivel female JIC

Adapteur mâle JIC x femelle tournante JIC

Nipples maschio JIC - femmina girevole JIC 37°

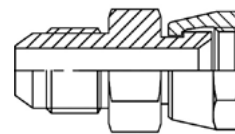

THREAD ROSCA	Part n° Referencia	€
7/16" 20h UNF	<b>S7400606</b>	<b>3,10</b>
1/2" 20h UNF	<b>S7400808</b>	<b>3,73</b>
9/16" 18h UNF	<b>S7401010</b>	<b>3,47</b>
3/4" 16h UNF	<b>S7401212</b>	<b>4,93</b>
7/8" 14h UNF	<b>S7401616</b>	<b>6,28</b>
1" 1/16 12 h UNF	<b>S7402020</b>	<b>7,01</b>
1" 5/16 12 h UNF	<b>S7402525</b>	<b>10,47</b>

## Codo 90° macho - macho JIC 37°

90° Male elbow male JIC 37°-male JIC 37°

Adapteur coude 90° mâle JIC 37° x mâle JIC 37°

Adattatore a 90° maschio-maschio JIC 37°

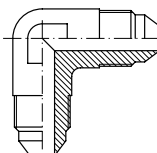

PIPE TUBO	THREAD ROSCA	Part n° Referencia	€	
6	1/4	7/16" 20h UNF	<b>S50006</b>	<b>2,83</b>
8	5/16	1/2" 20h UNF	<b>S50008</b>	<b>4,02</b>
10	3/8	9/16" 18h UNF	<b>S50010</b>	<b>3,30</b>
12	1/2	3/4" 16h UNF	<b>S50012</b>	<b>4,57</b>
14-15-16	5/8	7/8" 14h UNF	<b>S50016</b>	<b>5,95</b>
18-20	3/4	1" 1/16 12h UNF	<b>S50020</b>	<b>10,27</b>
25	1	1"5/16 12h UNF	<b>S50025</b>	<b>13,84</b>
30-32	1 1/4	1"5/8 12h UNF	<b>S50032</b>	<b>33,14</b>
38	1 1/2	1"7/8 12h UNF	<b>S50038</b>	<b>45,79</b>

## Codo 90° pasatabiques JIC 37°

90° Bulkhead coupling male JIC 37°-male JIC 37°

Adapteur coude 90° passe cloison mâle JIC 37° x mâle JIC 37° équipé

Adattatore a 90° passaparete maschio-maschio JIC 37°

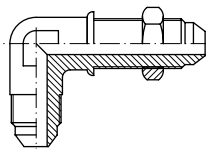

PIPE TUBO	THREAD ROSCA	Part n° Referencia	€	
6	6	7/16" 20h UNF	<b>S65006</b>	<b>4,51</b>
8	8	1/2" 20h UNF	<b>S65008</b>	<b>4,22</b>
10	10	9/16" 18h UNF	<b>S65010</b>	<b>4,69</b>
12	12	3/4" 16h UNF	<b>S65012</b>	<b>6,18</b>
14-15-16	14-15-16	7/8" 14h UNF	<b>S65016</b>	<b>9,08</b>
18-20	18-20	1" 1/16 12h UNF	<b>S65020</b>	<b>15,00</b>
25	25	1"5/16 12h UNF	<b>S65025</b>	<b>28,24</b>

## Codo 90° macho JIC 37° - macho BSPT

90° Male elbow male JIC 37° -male BSPT

Adapteur coude 90° mâle JIC 37° x mâle gaz conique

Adattatore a 90° maschio-maschio JIC 37°-BSPT

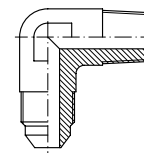

PIPE TUBO	THREAD ROSCA	Part n° Referencia	€		
6	1/4	7/16" 20h UNF	1/8" BSPT	<b>S5500610</b>	<b>7,04</b>
6	1/4	7/16" 20h UNF	1/4" BSPT	<b>S5500613</b>	<b>7,11</b>
8	5/16	1/2" 20h UNF	1/8" BSPT	<b>S5500810</b>	<b>10,32</b>
8	5/16	1/2" 20h UNF	1/4" BSPT	<b>S5500813</b>	<b>6,54</b>
10	3/8	9/16" 18h UNF	1/4" BSPT	<b>S5501013</b>	<b>5,56</b>
10	3/8	9/16" 18h UNF	3/8" BSPT	<b>S5501017</b>	<b>11,80</b>
10	3/8	9/16" 18h UNF	1/2" BSPT	<b>S5501021</b>	<b>14,48</b>
12	1/2	3/4" 16h UNF	1/4" BSPT	<b>S5501213</b>	<b>11,38</b>
12	1/2	3/4" 16h UNF	3/8" BSPT	<b>S5501217</b>	<b>7,46</b>
12	1/2	3/4" 16h UNF	1/2" BSPT	<b>S5501221</b>	<b>9,82</b>
14-15-16	5/8	7/8" 14h UNF	3/8" BSPT	<b>S5501617</b>	<b>15,22</b>
14-15-16	5/8	7/8" 14h UNF	1/2" BSPT	<b>S5501621</b>	<b>9,02</b>
14-15-16	5/8	7/8" 14h UNF	3/4" BSPT	<b>S5501626</b>	<b>22,45</b>
18-20	3/4	1" 1/16 12h UNF	1/2" BSPT	<b>S5502021</b>	<b>19,33</b>
18-20	3/4	1" 1/16 12h UNF	3/4" BSPT	<b>S5502026</b>	<b>15,49</b>
25	1	1"5/16 12h UNF	3/4" BSPT	<b>S5502526</b>	<b>27,91</b>
25	1	1"5/16 12h UNF	1" BSPT	<b>S5502533</b>	<b>23,15</b>
30-32	1 1/4	1"5/8 12h UNF	1" BSPT	<b>S5503233</b>	<b>32,65</b>
30-32	1 1/4	1"5/8 12h UNF	1" 1/4 BSPT	<b>S5503242</b>	<b>33,64</b>
38	1 1/2	1"7/8 12h UNF	1" 1/2 BSPT	<b>S5503848</b>	<b>78,55</b>

# Racores JIC 37°

JIC 37° fittings

Raccords JIC 37°

Raccordi JIC 37°

Tr/Ale Pipe

Pipe Fittings, DIN 2353  
/ Flare fittings, JIC 37°

SAE Flanges

Tr/Ale Clamps

Machines for  
processing rigid pipes

## Codo 90° macho JIC 37° - macho NPT

90° Male elbow male JIC 37°-male NPT

Adapteur coude 90° mâle JIC 37° x mâle NPT

Adattatore a 90° maschio-maschio JIC 37°-NPT

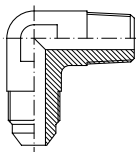

PIPE TUBO	THREAD ROSCA	Part n° Referencia	€		
6	1/4	7/16" 20h UNF	1/8" NPT	<b>S5250610</b>	<b>4,51</b>
6	1/4	7/16" 20h UNF	1/4" NPT	<b>S5250613</b>	<b>4,82</b>
8	5/16	1/2" 20h UNF	1/8" NPT	<b>S5250810</b>	<b>5,55</b>
8	5/16	1/2" 20h UNF	1/4" NPT	<b>S5250813</b>	<b>6,15</b>
10	3/8	9/16" 18h UNF	1/4" NPT	<b>S5251013</b>	<b>3,69</b>
10	3/8	9/16" 18h UNF	3/8" NPT	<b>S5251017</b>	<b>4,54</b>
10	3/8	9/16" 18h UNF	1/2" NPT	<b>S5251021</b>	<b>10,23</b>
12	1/2	3/4" 16h UNF	1/4" NPT	<b>S5251213</b>	<b>5,67</b>
12	1/2	3/4" 16h UNF	3/8" NPT	<b>S5251217</b>	<b>5,93</b>
12	1/2	3/4" 16h UNF	1/2" NPT	<b>S5251221</b>	<b>6,71</b>
14-15-16	5/8	7/8" 14h UNF	3/8" NPT	<b>S5251617</b>	<b>10,21</b>
14-15-16	5/8	7/8" 14h UNF	1/2" NPT	<b>S5251621</b>	<b>10,91</b>
14-15-16	5/8	7/8" 14h UNF	3/4" NPT	<b>S5251626</b>	<b>16,77</b>
18-20	3/4	1" 1/16 12h UNF	1/2" NPT	<b>S5252021</b>	<b>11,60</b>
18-20	3/4	1" 1/16 12h UNF	3/4" NPT	<b>S5252026</b>	<b>10,66</b>
25	1	1" 5/16 12h UNF	3/4" NPT	<b>S5252526</b>	<b>21,59</b>
25	1	1" 5/16 12h UNF	1" NPT	<b>S5252533</b>	<b>21,64</b>
30-32	1 1/4	1" 5/8 12h UNF	1" NPT	<b>S5253233</b>	<b>34,92</b>
30-32	1 1/4	1" 5/8 12h UNF	1" 1/4 NPT	<b>S5253242</b>	<b>34,90</b>
38	1 1/2	1" 7/8 12h UNF	1" 1/2 NPT	<b>S5253848</b>	<b>58,15</b>

## Codo 90° macho - hembra giratoria JIC 37°

90° Elbow swivel female JIC 37°-male JIC 37°

Adapteur coude 90° mâle JIC 37° x femelle tournante JIC 37°

Adattatore a 90° maschio-femmina girevole JIC 37°

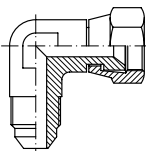

PIPE TUBO	THREAD ROSCA	Part n° Referencia	€	
6	1/4	7/16" 20h UNF	<b>S67506</b>	<b>3,78</b>
8	5/16	1/2" 20h UNF	<b>S67508</b>	<b>4,99</b>
10	3/8	9/16" 18h UNF	<b>S67510</b>	<b>5,28</b>
12	1/2	3/4" 16h UNF	<b>S67512</b>	<b>7,44</b>
14-15-16	5/8	7/8" 14h UNF	<b>S67516</b>	<b>7,74</b>
18-20	3/4	1" 1/16 12h UNF	<b>S67520</b>	<b>9,26</b>
25	1	1" 5/16 12h UNF	<b>S67525</b>	<b>20,83</b>
30-32	1 1/4	1" 5/8 12h UNF	<b>S67532</b>	<b>56,26</b>
38	1 1/2	1" 7/8 12h UNF	<b>S67538</b>	<b>50,15</b>

## Codo 90° hembra giratoria JIC 37°- Macho NPT (60°)

90° Elbow swivel female JIC 37°-NPT male (60°)

Adapteur coude 90° femelle tournante JIC 37° x mâle NPT (60°)

Adattatore a 90° femmina girevole JIC 37°-maschio NPT (60°)

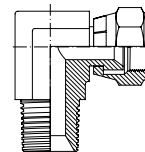

PIPE TUBO	THREAD ROSCA	Part n° Referencia	€		
6	1/4	F 7/16" 20h UNF	M 1/4" NPT	<b>S5950604</b>	<b>4,50</b>
8	5/16	F 1/2" 20h UNF	M 1/4" NPT	<b>S5950804</b>	<b>5,57</b>
10	3/8	F 9/16" 18h UNF	M 1/4" NPT	<b>S5951004</b>	<b>5,65</b>
10	3/8	F 9/16" 18h UNF	M 3/8" NPT	<b>S5951006</b>	<b>5,65</b>
12	1/2	3/4" 16h UNF	M 3/8" NPT	<b>S5951206</b>	<b>7,77</b>
12	1/2	3/4" 16h UNF	M 1/2" NPT	<b>S5951208</b>	<b>7,86</b>
14-15-16	5/8	7/8" 14h UNF	M 1/2" NPT	<b>S5951608</b>	<b>8,35</b>
18-20	3/4	1" 1/16 12 h UNF	M 3/4" NPT	<b>S5952012</b>	<b>11,38</b>
25	1	1" 5/16 12 h UNF	M 1" NPT	<b>S5952516</b>	<b>22,01</b>

## Codo 90° hembra giratoria JIC 37°- hembra giratoria JIC 37°

90° Elbow swivel female JIC 37°-swivel female JIC 37°

Adapteur coude 90° femelle tournante JIC 37° x femelle tournante JIC 37°

Adattatore a 90° femmina girevole JIC 37°-femmina girevole JIC 37°

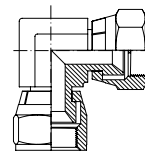

PIPE TUBO	THREAD ROSCA	Part n° Referencia	€
6	7/16" 20h UNF	<b>S6650606</b>	<b>5,32</b>
8	1/2" 20h UNF	<b>S6650808</b>	<b>6,47</b>
10	9/16" 18h UNF	<b>S6651010</b>	<b>6,47</b>
12	3/4" 16h UNF	<b>S6651212</b>	<b>7,53</b>
14-15-16	7/8" 14h UNF	<b>S6651616</b>	<b>13,75</b>
18-20	1" 1/16 12 h UNF	<b>S6652020</b>	<b>23,41</b>
25	1" 5/16 12 h UNF	<b>S6652525</b>	<b>29,38</b>

## Codo 45° macho - hembra giratoria JIC 37°

45° Elbow male-swivel female JIC 37°

Adapteur coude 45° mâle JIC 37° x femelle tournante JIC 37°

Adattatore a 45° maschio-femmina girevole JIC 37°

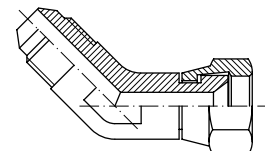

PIPE TUBO	THREAD ROSCA	Part n° Referencia	€	
6	1/4	7/16" 20h UNF	<b>S69006</b>	<b>3,64</b>
8	5/16	1/2" 20h UNF	<b>S69008</b>	<b>5,90</b>
10	3/8	9/16" 18h UNF	<b>S69010</b>	<b>5,84</b>
12	1/2	3/4" 16h UNF	<b>S69012</b>	<b>5,86</b>
14-15-16	5/8	7/8" 14h UNF	<b>S69016</b>	<b>10,00</b>
18-20	3/4	1" 1/16 12h UNF	<b>S69020</b>	<b>12,87</b>
25	1	1" 5/16 12h UNF	<b>S69025</b>	<b>21,55</b>

# Racores JIC 37°

JIC 37° fittings

Raccords JIC 37°

Raccordi JIC 37°

## Codo 90° macho JIC 37° - macho BSP orientable

90° Elbow male JIC 37°-BSP adjustable male

Adapteur orientable coude 90° mâle JIC 37° x mâle gaz cyl + o'ring équipé

Adattatore a 90° maschio-maschio orientabile JIC 37°-BSP

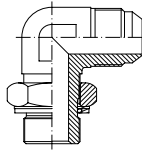

PIPE TUBO		THREAD ROSCA		Part n° Referencia	€
6	1/4	7/16" 20h UNF	1/8" BSP	<b>S6000610</b>	<b>3,58</b>
6	1/4	7/16" 20h UNF	1/4" BSP	<b>S6000613</b>	<b>4,57</b>
8	5/16	1/2" 20h UNF	1/8" BSP	<b>S6000810</b>	<b>4,42</b>
8	5/16	1/2" 20h UNF	1/4" BSP	<b>S6000813</b>	<b>5,21</b>
10	3/8	9/16" 18h UNF	1/4" BSP	<b>S6001013</b>	<b>4,73</b>
10	3/8	9/16" 18h UNF	3/8" BSP	<b>S6001017</b>	<b>5,09</b>
10	3/8	9/16" 18h UNF	1/2" BSP	<b>S6001021</b>	<b>11,70</b>
12	1/2	3/4" 16h UNF	3/4" BSP	<b>S6001213</b>	<b>5,95</b>
12	1/2	3/4" 16h UNF	3/8" BSP	<b>S6001217</b>	<b>6,32</b>
12	1/2	3/4" 16h UNF	1/2" BSP	<b>S6001221</b>	<b>7,75</b>
16	5/8	7/8" 14h UNF	3/8" BSP	<b>S6001617</b>	<b>8,04</b>
14-15-16	5/8	7/8" 14h UNF	1/2" BSP	<b>S6001621</b>	<b>8,11</b>
18-20	3/4	1"1/16 12h UNF	1/2" BSP	<b>S6002021</b>	<b>11,23</b>
18-20	3/4	1"1/16 12h UNF	3/4" BSP	<b>S6002026</b>	<b>10,94</b>
18-20	3/4	1"1/16 12h UNF	1" BSP	<b>S6002033</b>	<b>18,97</b>
25	1	1"5/16 12h UNF	3/4" BSP	<b>S6002526</b>	<b>18,28</b>
25	1	1"5/16 12h UNF	1" BSP	<b>S6002533</b>	<b>20,31</b>
30-32	1 1/4	1"5/8 12h UNF	1" BSP	<b>S6003233</b>	<b>26,41</b>
30-32	1 1/4	1"5/8 12h UNF	1"1/4 BSP	<b>S6003242</b>	<b>34,37</b>
38	1 1/2	1"7/8 12h UNF	1"1/4 BSP	<b>S6003842</b>	<b>65,46</b>
38	1 1/2	1"7/8 12h UNF	1"1/2 BSP	<b>S6003848</b>	<b>77,88</b>

## Codo 45° macho JIC 37° - macho BSP orientable

45° Elbow male JIC 37°-BSP adjustable male

Adapteur coude 45° mâle JIC 37° x mâle gaz cyl + o'ring équipé

Adattatore a 45° maschio JIC 37°-maschio BSP orientabile

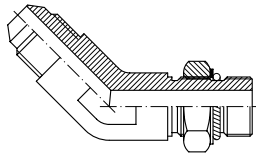

PIPE TUBO		THREAD ROSCA		Part n° Referencia	€
8	5/16	1/2" 20h UNF	1/4" BSP	<b>S6150813</b>	<b>4,71</b>
10	3/8	9/16" 18h UNF	1/4" BSP	<b>S6151013</b>	<b>5,43</b>
12	1/2	3/4" 16h UNF	3/8" BSP	<b>S6151217</b>	<b>6,85</b>
12	1/2	3/4" 16h UNF	1/2" BSP	<b>S6151221</b>	<b>7,59</b>
14-15-16	5/8	7/8" 14h UNF	1/2" BSP	<b>S6151621</b>	<b>8,11</b>
18-20	3/4	1"1/16 12h UNF	1/2" BSP	<b>S6152021</b>	<b>11,78</b>
18-20	3/4	1"1/16 12h UNF	3/4" BSP	<b>S6152026</b>	<b>11,77</b>
25	1	1"5/16 12h UNF	1" BSP	<b>S6152533</b>	<b>18,84</b>

## Codo 90° macho JIC 37° - macho UNF orientable

90° Elbow male JIC 37°-unf adjustable male

Adapteur orientable coude 90° mâle JIC 37° x mâle UNF + o'ring équipé

Adattatore a 90° maschio-maschio orientabile JIC 37°-UNF

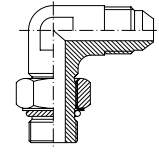

PIPE TUBO		THREAD ROSCA		Part n° Referencia	€
6	1/4	7/16" 20h JIC	7/16" 20h UNF	<b>S5750611</b>	<b>3,87</b>
6	1/4	7/16" 20h JIC	1/2" 20h UNF	<b>S5750612</b>	<b>7,86</b>
8	5/16	1/2" 20h JIC	1/2" 20h UNF	<b>S5750812</b>	<b>4,76</b>
10	3/8	9/16" 18h JIC	9/16" 18h UNF	<b>S5751014</b>	<b>6,00</b>
10	3/8	9/16" 18h JIC	3/4" 16h UNF	<b>S5751019</b>	<b>6,73</b>
12	1/2	3/4" 16h JIC	3/4" 16h UNF	<b>S5751219</b>	<b>5,65</b>
12	1/2	3/4" 16h JIC	7/8" 14h UNF	<b>S5751222</b>	<b>12,59</b>
14-15-16	5/8	7/8" 14h JIC	3/4" 16h UNF	<b>S5751619</b>	<b>13,44</b>
14-15-16	5/8	7/8" 14h JIC	7/8" 14h UNF	<b>S5751622</b>	<b>11,18</b>
18-20	3/4	1"1/16 12h JIC	7/8" 14h UNF	<b>S5752022</b>	<b>15,96</b>
18-20	3/4	1"1/16 12h JIC	1"1/16 12h UNF	<b>S5752027</b>	<b>13,25</b>
25	1	1"5/16 12h JIC	1"1/16 12h UNF	<b>S5752527</b>	<b>27,42</b>
25	1	1"5/16 12h JIC	1"5/16 12h UNF	<b>S5752533</b>	<b>22,53</b>
30-32	1 1/4	1"5/8 12h JIC	1"5/8 12h UNF	<b>S5753241</b>	<b>44,67</b>
38	1 1/2	1"7/8 12h JIC	1"7/8 12h UNF	<b>S5753848</b>	<b>68,31</b>

## Codo 90° macho JIC 37° - macho métrico orientable

90° Elbow male JIC 37°-Metric adjustable male

Adapteur orientable coude 90° mâle JIC 37° x mâle Métrique + o'ring équipé

Adattatore a 90° maschio-maschio orientabile JIC 37° Metrico

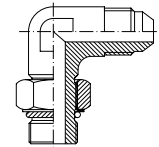

PIPE TUBO		THREAD ROSCA		Part n° Referencia	€
6	1/4	7/16" 20h UNF	M10x1	<b>S6250610</b>	<b>4,14</b>
8	5/16	1/2" 20h UNF	M12x1,5	<b>S6250812</b>	<b>9,74</b>
10	3/8	9/16" 18h UNF	M14x1,5	<b>S6251014</b>	<b>5,59</b>
12	1/2	3/4" 16h UNF	M16x1,5	<b>S6251216</b>	<b>10,98</b>
12	1/2	3/4" 16h UNF	M18x1,5	<b>S6251218</b>	<b>6,78</b>
14-15-16	5/8	7/8" 14h UNF	M18x1,5	<b>S6251618</b>	<b>12,57</b>
14-15-16	5/8	7/8" 14h UNF	M22x1,5	<b>S6251622</b>	<b>10,46</b>
18-20	3/4	1"1/16 12h UNF	M22x1,5	<b>S6252022</b>	<b>14,89</b>
18-20	3/4	1"1/16 12h UNF	M27x2	<b>S6252027</b>	<b>19,61</b>
25	1	1"5/16 12h UNF	M33x2	<b>S6252533</b>	<b>22,67</b>

## Codo 45° macho JIC 37° - macho UNF orientable

45° Elbow male JIC 37°-UNF adjustable male

Adapteur coude 45° mâle JIC 37° x mâle gaz UNF + o'ring équipé

Adattatore a 45° maschio JIC 37°-maschio UNF orientabile

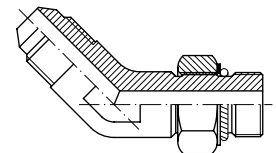

PIPE TUBO		THREAD ROSCA		Part n° Referencia	€
6	1/4	7/16" 20h JIC	7/16" 20h UNF	<b>S7750611</b>	<b>3,11</b>
8	5/16	1/2" 20h JIC	1/2" 20h UNF	<b>S7750812</b>	<b>3,63</b>
10	3/8	9/16" 18h JIC	9/16" 18h UNF	<b>S7751014</b>	<b>3,63</b>
12	1/2	3/4" 16h JIC	3/4" 16h UNF	<b>S7751219</b>	<b>4,97</b>
14-15-16	5/8	7/8" 14h JIC	7/8" 14h UNF	<b>S7751622</b>	<b>7,04</b>
18-20	3/4	1"1/16 12h JIC	1"1/16 12h UNF	<b>S7752027</b>	<b>11,40</b>
25	1	1"5/16 12h JIC	1"5/16 12h UNF	<b>S7752533</b>	<b>16,58</b>

# Racores JIC 37°

JIC 37° fittings

Raccords JIC 37°

Raccordi JIC 37°

## Tes macho-macho-macho JIC 37°

Union Tee male JIC 37°

Tés égaux mâle JIC 37°

Adattatore a T maschio JIC 37°

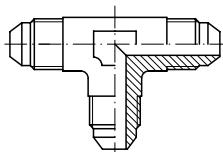

PIPE TUBO		THREAD ROSCA	Part nº Referencia	€
6	1/4	7/16" 20h UNF	<b>S50506</b>	<b>4,32</b>
8	5/16	1/2" 20h UNF	<b>S50508</b>	<b>4,47</b>
10	3/8	9/16" 18h UNF	<b>S50510</b>	<b>5,28</b>
12	1/2	3/4" 16h UNF	<b>S50512</b>	<b>8,04</b>
14-15-16	5/8	7/8" 14h UNF	<b>S50516</b>	<b>9,67</b>
18-20	3/4	1" 1/16 12h UNF	<b>S50520</b>	<b>11,83</b>
25	1	1" 5/16 12h UNF	<b>S50525</b>	<b>18,53</b>
30-32	1 1/4	1" 5/8 12h UNF	<b>S50532</b>	<b>45,85</b>
38	1 1/2	1" 7/8 12h UNF	<b>S50538</b>	<b>126,69</b>

## Tes macho-macho-hembra giratoria JIC 37°

Swivel barrel tee male JIC 37°-male JIC 37°-swivel female JIC 37°

Tés égaux tournantes JIC 37° au latéral

Adattatore a T maschio-maschio-femmina girevole JIC 37°

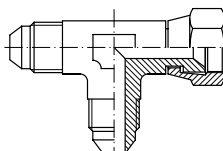

PIPE TUBO		THREAD ROSCA	Part nº Referencia	€
6	1/4	7/16" 20h UNF	<b>S68006</b>	<b>5,95</b>
8	5/16	1/2" 20h UNF	<b>S68008</b>	<b>6,10</b>
10	3/8	9/16" 18h UNF	<b>S68010</b>	<b>5,65</b>
12	1/2	3/4" 16h UNF	<b>S68012</b>	<b>8,62</b>
14-15-16	5/8	7/8" 14h UNF	<b>S68016</b>	<b>10,17</b>
18-20	3/4	1" 1/16 12h UNF	<b>S68020</b>	<b>14,69</b>
25	1	1" 5/16 12h UNF	<b>S68025</b>	<b>25,89</b>
30-32	1 1/4	1" 5/8 12h UNF	<b>S68032</b>	<b>67,72</b>
38	1 1/2	1" 7/8 12h UNF	<b>S68038</b>	<b>101,13</b>

## Tes macho-hembra giratoria-macho JIC 37°

Swivel brunch tee male JIC 37°-swivel female JIC 37°-male JIC 37°

Tés égaux tournantes JIC 37° au centre

Adattatore a T maschio-femmina girevole-maschio JIC 37°

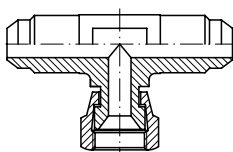

PIPE TUBO		THREAD ROSCA	Part nº Referencia	€
6	1/4	7/16" 20h UNF	<b>S68506</b>	<b>6,20</b>
8	5/16	1/2" 20h UNF	<b>S68508</b>	<b>6,10</b>
10	3/8	9/16" 18h UNF	<b>S68510</b>	<b>5,65</b>
12	1/2	3/4" 16h UNF	<b>S68512</b>	<b>9,61</b>
14-15-16	5/8	7/8" 14h UNF	<b>S68516</b>	<b>11,71</b>
18-20	3/4	1" 1/16 12h UNF	<b>S68520</b>	<b>13,62</b>
25	1	1" 5/16 12h UNF	<b>S68525</b>	<b>40,35</b>
30-32	1 1/4	1" 5/8 12h UNF	<b>S68532</b>	<b>66,41</b>
38	1 1/2	1" 7/8 12h UNF	<b>S68538</b>	<b>99,32</b>

## Te H.G. JIC 37° - H.G. JIC 37° - H.G. JIC 37°

Tee swivel female JIC 37° - swivel female JIC 37° - swivel female JIC 37°

Té femelle tournante JIC - femelle tournante JIC - femelle tournante JIC

Raccordo a T JIC 37° (F-F-Orientabile)

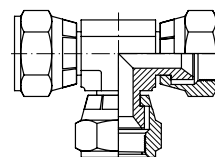

PIPE TUBO		THREAD ROSCA	Part nº Referencia	€
6	1/4	7/16" 20h UNF	<b>S6700606</b>	<b>12,69</b>
8	5/16	1/2" 20h UNF	<b>S6700808</b>	<b>15,39</b>
10	3/8	9/16" 18h UNF	<b>S6701010</b>	<b>15,39</b>
12	1/2	3/4" 16h UNF	<b>S6701212</b>	<b>19,23</b>
14-15-16	5/8	7/8" 14h UNF	<b>S6701616</b>	<b>26,76</b>
18-20	3/4	1" 1/16 12 h UNF	<b>S6702020</b>	<b>33,64</b>
25	1	1" 5/16 12 h UNF	<b>S6702525</b>	<b>56,06</b>

## Te Macho JIC 37° - Macho BSPT (60°) - Macho JIC 37°

Brunch tee male JIC 37°-BSPT male 60°-male JIC 37°

Té mâle JIC 37° - mâle BSPT 60° - mâle JIC 37°

Raccordo a T JIC 37° orientabile centrale BSPT (M-M orientabile-M)

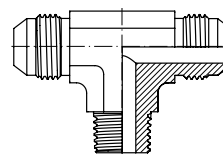

PIPE TUBO		THREAD ROSCA		Part nº Referencia	€
6	1/4	7/16" 20h UNF	1/4" BSPT	<b>S6810604</b>	<b>5,57</b>
8	5/16	1/2" 20h UNF	1/4" BSPT	<b>S6810804</b>	<b>7,77</b>
10	3/8	9/16" 18h UNF	1/4" BSPT	<b>S6811004</b>	<b>6,14</b>
10	3/8	9/16" 18h UNF	3/8" BSPT	<b>S6811006</b>	<b>7,45</b>
12	1/2	3/4" 16h UNF	3/8" BSPT	<b>S6811206</b>	<b>9,98</b>
12	1/2	3/4" 16h UNF	1/2" BSPT	<b>S6811208</b>	<b>10,48</b>
14-15-16	5/8	7/8" 14h UNF	1/2" BSPT	<b>S6811608</b>	<b>11,05</b>
18-20	3/4	1" 1/16 12 h UNF	3/4" BSPT	<b>S6812012</b>	<b>14,57</b>
25	1	1" 5/16 12 h UNF	1" BSPT	<b>S6812516</b>	<b>27,42</b>

## Te Macho JIC 37° - Macho NPT (60°) - Macho JIC 37°

Brunch tee male JIC 37°-NPT male 60°-male JIC 37°

Té mâle JIC 37° - mâle NPT 60° - mâle JIC 37°

Raccordo a T JIC 37° orientabile centrale NPT (M-M orientabile-M)

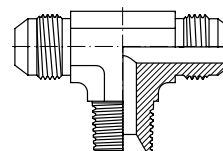

PIPE TUBO		THREAD ROSCA		Part nº Referencia	€
6	1/4	7/16" 20h UNF	1/4" NPT	<b>S6950604</b>	<b>4,67</b>
8	5/16	1/2" 20h UNF	1/4" NPT	<b>S6950804</b>	<b>5,07</b>
10	3/8	9/16" 18h UNF	1/4" NPT	<b>S6951004</b>	<b>5,65</b>
10	3/8	9/16" 18h UNF	3/8" NPT	<b>S6951006</b>	<b>7,12</b>
12	1/2	3/4" 16h UNF	3/8" NPT	<b>S6951206</b>	<b>7,61</b>
12	1/2	3/4" 16h UNF	1/2" NPT	<b>S6951208</b>	<b>8,84</b>
14-15-16	5/8	7/8" 14h UNF	1/2" NPT	<b>S6951608</b>	<b>11,05</b>
18-20	3/4	1" 1/16 12 h UNF	3/4" NPT	<b>S6952012</b>	<b>14,49</b>
25	1	1" 5/16 12 h UNF	1" NPT	<b>S6952516</b>	<b>27,42</b>

# Racores JIC 37°

JIC 37° fittings

Raccords JIC 37°

Raccordi JIC 37°

## Te macho JIC37° - macho orientable BSP - macho JIC37°

Tee male JIC 37°-BSP adjustable brunch male-male JIC 37°

Té mâle JIC 37° - mâle orientable BSP - mâle JIC 37°

Raccordo a T JIC 37° orientabile centrale BSP (M-M orientabile-M)

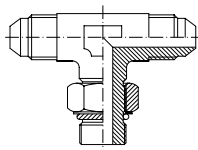

PIPE TUBO		THREAD ROSCA		Part n° Referencia	€
6	1/4	7/16" 20h UNF	1/4" BSP	<b>S6100613</b>	<b>5,94</b>
8	5/16	1/2" 20h UNF	1/4" BSP	<b>S6100813</b>	<b>9,60</b>
10	3/8	9/16" 18h UNF	1/4" BSP	<b>S6101013</b>	<b>6,03</b>
12	1/2	3/4" 16h UNF	3/8" BSP	<b>S6101217</b>	<b>8,04</b>
14-15-16	5/8	7/8" 14h UNF	1/2" BSP	<b>S6101621</b>	<b>13,02</b>
18-20	3/4	1"1/16 12h UNF	3/4" BSP	<b>S6102026</b>	<b>23,68</b>
25	1	1"5/16 12h UNF	1" BSP	<b>S6102533</b>	<b>27,26</b>
30-32	1 1/4	1"5/8 12h UNF	1"1/4 BSP	<b>S6103242</b>	<b>76,07</b>

## Te macho JIC 37° - macho orientable UNF-macho JIC37°

Tee male JIC 37°-adjustable brunch UNF-male JIC 37°

Té mâle JIC 37° - mâle orientable UNF - mâle JIC 37°

Raccordo a T JIC 37° orientabile centrale UNF (M-M orientabile-M)

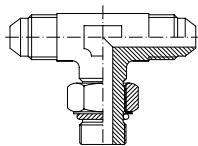

PIPE TUBO		THREAD ROSCA		Part n° Referencia	€
6	1/4	7/16" 20h UNF		<b>S5850611</b>	<b>11,25</b>
8	5/16	1/2" 20h UNF		<b>S5850812</b>	<b>15,05</b>
10	3/8	9/16" 18h UNF		<b>S5851014</b>	<b>15,37</b>
12	1/2	3/4" 16h UNF		<b>S5851219</b>	<b>15,15</b>
14-15-16	5/8	7/8" 14h UNF		<b>S5851622</b>	<b>22,85</b>
18-20	3/4	1"1/16 12h UNF		<b>S5852027</b>	<b>30,17</b>
25	1	1"5/16 12h UNF		<b>S5852533</b>	<b>45,21</b>

## Te macho JIC 37° - macho orientable métrico-macho JIC37°

Tee male JIC 37°-metric adjustable brunch male-male JIC 37°

Té mâle JIC 37° - mâle orientable Métrique - mâle JIC 37°

Raccordo a T JIC 37° orientabile centrale Metrico (M-M orientabile-M)

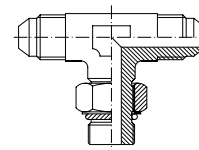

PIPE TUBO		THREAD ROSCA		Part n° Referencia	€
8	5/16	1/2" JIC	M12X1.5	<b>S6350812</b>	<b>13,81</b>
10	3/8	9/16" JIC	M14X1.5	<b>S6351014</b>	<b>11,92</b>
12	1/2	3/4" JIC	M18X1.5	<b>S6351218</b>	<b>16,26</b>
14-15-16	5/8	7/8" JIC	M18X1.5	<b>S6351618</b>	<b>25,33</b>
14-15-16	5/8	7/8" JIC	M22X1.5	<b>S6351622</b>	<b>25,33</b>
18-20	3/4	1"1/16 JIC	M27X2	<b>S6352027</b>	<b>31,78</b>
25	1	1"5/16 JIC	M33X2	<b>S6352533</b>	<b>41,52</b>

## Te macho JIC 37°- macho JIC37°- macho orientable BSP

Tee male JIC 37°-male JIC 37°-male BSP adjustable barrel

Té mâle JIC 37° - mâle JIC 37° - mâle orientable BSP

Raccordo a T JIC 37° orientabile laterale BSP (M-M-M orientabile)

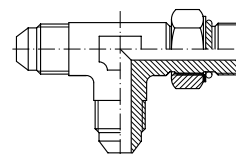

PIPE TUBO		THREAD ROSCA		Part n° Referencia	€
8	5/16	1/2" 20h UNF	1/4" BSP	<b>S6050813</b>	<b>5,30</b>
10	3/8	9/16" 18h UNF	1/4" BSP	<b>S6051013</b>	<b>8,70</b>
12	1/2	3/4" 16h UNF	3/8" BSP	<b>S6051217</b>	<b>7,74</b>
14-15-16	5/8	7/8" 14h UNF	1/2" BSP	<b>S6051621</b>	<b>11,09</b>
18-20	3/4	1"1/16 12h UNF	3/4" BSP	<b>S6052026</b>	<b>21,38</b>
25	1	1"5/16 12h UNF	1" BSP	<b>S6052533</b>	<b>36,57</b>
30-32	1 1/4	1"5/8 12h UNF	1"1/4 BSP	<b>S6053242</b>	<b>61,87</b>
38	1 1/2	1"7/8 12h UNF	1"1/2 BSP	<b>S6053848</b>	<b>82,44</b>

## Te macho JIC 37° - macho JIC37°- macho orientable UNF

Tee male JIC 37°-male JIC37°- adjustable barrel UNF

Té mâle JIC 37° - mâle JIC 37° - mâle orientable UNF

Raccordo a T JIC 37° orientabile laterale UNF (M-M-M orientabile)

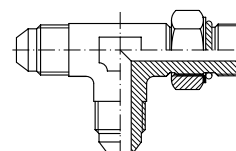

PIPE TUBO		THREAD ROSCA		Part n° Referencia	€
6	1/4	7/16" JIC	7/16" UNF	<b>S5800611</b>	<b>17,80</b>
8	5/16	1/2" JIC	1/2" UNF	<b>S5800812</b>	<b>17,80</b>
10	3/8	9/16" JIC	9/16" UNF	<b>S5801014</b>	<b>10,88</b>
16	5/8	7/8" JIC	7/8" UNF	<b>S5801622</b>	<b>21,44</b>
20	3/4	1"1/16 JIC	1"1/16 UNF	<b>S5802027</b>	<b>33,14</b>
25	1	1"5/16 JIC	1"5/16 UNF	<b>S5802533</b>	<b>49,33</b>

## Bridas SAE

*SAE Flanges*

Brides de fixation SAE

*Flangia SAE*

## Bridas SAE

*SAE Flanges*

Brides de fixation SAE

*Flange SAE*

3

# Bridas SAE

SAE Flanges  
Brides de fixation SAE  
Flange SAE

- Bridas Roscadas / Threaded flanges / Brides taraudées / Flangia filettate | 246

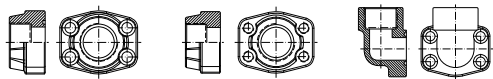

BBRG

BCRG

B90RG

- Bridas soldables tubo gas / Welding flanges for gas tube / Brides à souder pour tube gaz / Flangia a saldare per tubo gas | 247

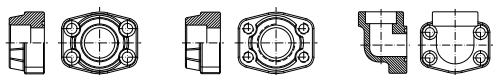

BBSG

BCSG

B90SG

- Bridas soldables tubo métrico / Welding flanges for metric tube / Brides à souder pour tube métrique / Flangia a saldare per tubo Metrico | 248

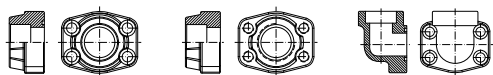

BBSM

BCSM

B90SM

- Bridas soldables macho / Male welding flanges / Brides à souder mâle / Flangia a saldare maschio | 249

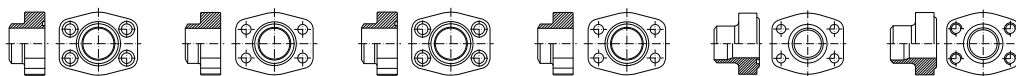

BMSG

BMSG

BMSM

BCMSM

BMSLM

BCMSLM

- Accesorios bridas / Flange accessories / Accessoires pour brides / Accessori flangia | 251



TBSAE

JBR

JUNTAS

- Bridas roscadas macho / Male threaded flanges / Brides taraudées mâle / Flangia filettate maschio | 252

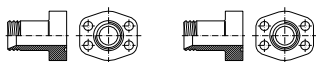

BMRG

BMRM

- Bridas ciegas / Blind flanges / Brides avec obturateur fermé / Flangia cieche | 252

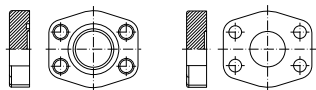

BBC

BCC

- Bridas para flexibles / SAE Flanges for hoses / Brides SAE pour flexibles / Flangia SAE per tubi flessibili | 253

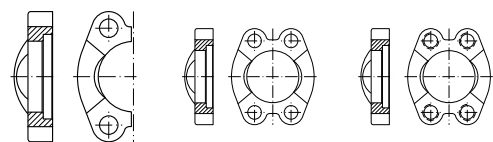

BBP

BBE

BCE

# Bridas SAE

SAE Flanges  
Brides de fixation SAE  
Flange SAE

- Conos soldar /Welding adaptors for flanges /Collets à souder /Codoli a saldare

| 254

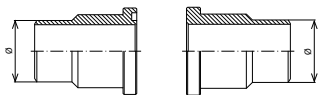

BSM31/61

BSM30/60

- Bridas Cetop /Cetop flanges /Brides Cetop /Flangia Cetop

| 254

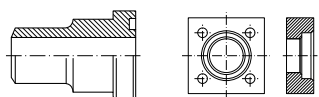

BCTS

BCT

# Bridas SAE

SAE Flanges  
Brides de fixation SAE  
Flange SAE

## Brida roscada hembra BSP

BSP Female threaded flange

Bride taraudée femelle BSP

Flangia filettata femmina BSP

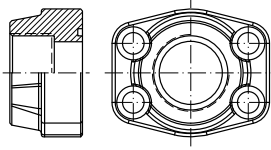

SERIE	THREAD ROSCA	SIZE TAMAÑO	Part nº Referencia	€
3000 PSI	1/2" BSP	1/2"	<b>BBRG30808</b>	<b>13,45</b>
3000 PSI	3/8" BSP	1/2"	<b>BBRG30806</b>	<b>13,45</b>
3000 PSI	3/4" BSP	3/4"	<b>BBRG31212</b>	<b>15,33</b>
3000 PSI	1/2" BSP	3/4"	<b>BBRG31208</b>	<b>15,33</b>
3000 PSI	1" BSP	1"	<b>BBRG31616</b>	<b>17,75</b>
3000 PSI	3/4" BSP	1"	<b>BBRG31612</b>	<b>17,75</b>
3000 PSI	1"1/4 BSP	1"1/4	<b>BBRG32020</b>	<b>22,14</b>
3000 PSI	1" BSP	1"1/4	<b>BBRG32016</b>	<b>22,14</b>
3000 PSI	1"1/2 BSP	1"1/2	<b>BBRG32424</b>	<b>25,72</b>
3000 PSI	1"1/4 BSP	1"1/2	<b>BBRG32420</b>	<b>29,12</b>
3000 PSI	2" BSP	2"	<b>BBRG33232</b>	<b>36,10</b>
3000 PSI	1"1/2 BSP	2"	<b>BBRG33224</b>	<b>29,36</b>
3000 PSI	2"1/2 BSP	2"1/2	<b>BBRG34040</b>	<b>49,21</b>
3000 PSI	2" BSP	2"1/2	<b>BBRG34032</b>	<b>49,21</b>
3000 PSI	2"1/2 BSP	3"	<b>BBRG34840</b>	<b>48,82</b>
3000 PSI	3" BSP	3"	<b>BBRG34848</b>	<b>44,65</b>
3000 PSI	3"1/2 BSP	3"1/2	<b>BBRG35656</b>	<b>96,87</b>
3000 PSI	3" BSP	3"1/2	<b>BBRG35648</b>	<b>91,64</b>
3000 PSI	4" BSP	4"	<b>BBRG36464</b>	<b>77,79</b>
3000 PSI	3"1/2 BSP	4"	<b>BBRG36456</b>	<b>99,33</b>
6000 PSI	1/2" BSP	1/2"	<b>BBRG60808</b>	<b>14,14</b>
6000 PSI	3/8" BSP	1/2"	<b>BBRG60806</b>	<b>14,14</b>
6000 PSI	3/4" BSP	3/4"	<b>BBRG61212</b>	<b>21,09</b>
6000 PSI	1/2" BSP	3/4"	<b>BBRG61208</b>	<b>21,09</b>
6000 PSI	1" BSP	1"	<b>BBRG61616</b>	<b>25,72</b>
6000 PSI	3/4" BSP	1"	<b>BBRG61612</b>	<b>25,72</b>
6000 PSI	1"1/4 BSP	1"1/4	<b>BBRG62020</b>	<b>36,69</b>
6000 PSI	1" BSP	1"1/4	<b>BBRG62016</b>	<b>36,69</b>
6000 PSI	1"1/4 BSP	1"1/2	<b>BBRG62420</b>	<b>61,10</b>
6000 PSI	1"1/2 BSP	1"1/2	<b>BBRG62424</b>	<b>61,10</b>
6000 PSI	2" BSP	2"	<b>BBRG63232</b>	<b>88,37</b>
6000 PSI	1"1/2 BSP	2"	<b>BBRG63224</b>	<b>88,37</b>

## Contrabrida roscada hembra BSP

BSP Female threaded counter-flange

Contre-bride taraudée femelle BSP

Controflangia filettata femmina BSP

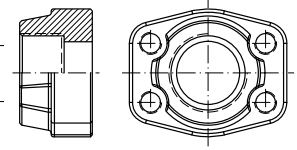

SERIE	THREAD ROSCA	SIZE TAMAÑO	Part nº Referencia	€
3000 PSI	1/2" BSP	1/2"	<b>BCRG30808</b>	<b>13,45</b>
3000 PSI	3/8" BSP	1/2"	<b>BCRG30806</b>	<b>15,51</b>
3000 PSI	3/4" BSP	3/4"	<b>BCRG31212</b>	<b>15,33</b>
3000 PSI	1/2" BSP	3/4"	<b>BCRG31208</b>	<b>15,22</b>
3000 PSI	1" BSP	1"	<b>BCRG31616</b>	<b>17,66</b>
3000 PSI	3/4" BSP	1"	<b>BCRG31612</b>	<b>17,61</b>
3000 PSI	1"1/4 BSP	1"1/4	<b>BCRG32020</b>	<b>23,40</b>
3000 PSI	1" BSP	1"1/4	<b>BCRG32016</b>	<b>23,64</b>
3000 PSI	1"1/2 BSP	1"1/2	<b>BCRG32424</b>	<b>27,04</b>
3000 PSI	1"1/4 BSP	1"1/2	<b>BCRG32420</b>	<b>38,41</b>
3000 PSI	2" BSP	2"	<b>BCRG33232</b>	<b>30,51</b>
3000 PSI	1"1/2 BSP	2"	<b>BCRG33224</b>	<b>33,91</b>
3000 PSI	2"1/2 BSP	2"1/2	<b>BCRG34040</b>	<b>48,90</b>
3000 PSI	2" BSP	2"1/2	<b>BCRG34032</b>	<b>53,40</b>
3000 PSI	3" BSP	3"	<b>BCRG34848</b>	<b>58,90</b>
3000 PSI	2"1/2 BSP	3"	<b>BCRG34840</b>	<b>64,40</b>
3000 PSI	3"1/2 BSP	3"1/2	<b>BCRG35656</b>	<b>83,92</b>
3000 PSI	3" BSP	3"1/2	<b>BCRG35648</b>	<b>69,45</b>
3000 PSI	4" BSP	4"	<b>BCRG36464</b>	<b>68,83</b>
3000 PSI	3"1/2 BSP	4"	<b>BCRG36456</b>	<b>75,24</b>
6000 PSI	1/2" BSP	1/2"	<b>BCRG60808</b>	<b>14,14</b>
6000 PSI	3/8" BSP	1/2"	<b>BCRG60806</b>	<b>14,14</b>
6000 PSI	3/4" BSP	3/4"	<b>BCRG61212</b>	<b>21,09</b>
6000 PSI	1/2" BSP	3/4"	<b>BCRG61208</b>	<b>21,09</b>
6000 PSI	1" BSP	1"	<b>BCRG61616</b>	<b>25,72</b>
6000 PSI	3/4" BSP	1"	<b>BCRG61612</b>	<b>24,26</b>
6000 PSI	1"1/4 BSP	1"1/4	<b>BCRG62020</b>	<b>36,69</b>
6000 PSI	1" BSP	1"1/4	<b>BCRG62016</b>	<b>33,91</b>
6000 PSI	1"1/2 BSP	1"1/2	<b>BCRG62424</b>	<b>61,10</b>
6000 PSI	1"1/4 BSP	1"1/2	<b>BCRG62420</b>	<b>48,82</b>
6000 PSI	2" BSP	2"	<b>BCRG63232</b>	<b>88,37</b>
6000 PSI	1"1/2 BSP	2"	<b>BCRG63224</b>	<b>64,19</b>

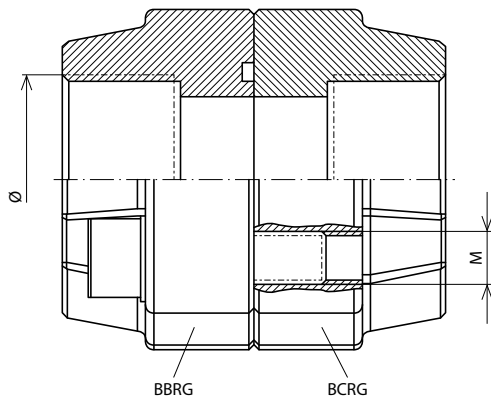

## Brida codo 90° roscada hembra BSP

90° BSP female threaded flange

Bride 90° taraudée femelle BSP

Flangia a 90° filettata femmina BSP

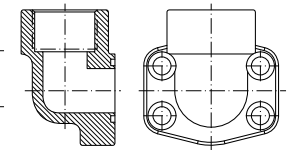

SERIE	THREAD ROSCA	SIZE TAMAÑO	Part nº Referencia	€
3000 PSI	1/2" BSP	1/2"	<b>B90RG30808</b>	<b>30,82</b>
3000 PSI	3/8" BSP	1/2"	<b>B90RG30806</b>	<b>32,75</b>
3000 PSI	3/4" BSP	3/4"	<b>B90RG31212</b>	<b>35,46</b>
3000 PSI	1" BSP	1"	<b>B90RG31616</b>	<b>37,93</b>
3000 PSI	1"1/4 BSP	1"1/4	<b>B90RG32020</b>	<b>44,26</b>
3000 PSI	1"1/2 BSP	1"1/2	<b>B90RG32424</b>	<b>56,55</b>
3000 PSI	2" BSP	2"	<b>B90RG33232</b>	<b>68,37</b>
6000 PSI	1/2" BSP	1/2"	<b>B90RG60808</b>	<b>35,92</b>
6000 PSI	3/8" BSP	1/2"	<b>B90RG60806</b>	<b>35,92</b>
6000 PSI	3/4" BSP	3/4"	<b>B90RG61212</b>	<b>38,16</b>
6000 PSI	1" BSP	1"	<b>B90RG61616</b>	<b>43,88</b>
6000 PSI	1"1/4 BSP	1"1/4	<b>B90RG62020</b>	<b>55,93</b>
6000 PSI	1"1/2 BSP	1"1/2	<b>B90RG62424</b>	<b>67,75</b>

# Bridas SAE

SAE Flanges  
Brides de fixation SAE  
Flange SAE

Table Pipe

Pipe Fittings DIN 2353  
/ Flare fittings JIC 37°

SAE Flanges

Table Clamps

Machines for  
processing rigid pipes

## Brida soldable hembra tubo gas

Welding female flange for gas tube

Bride à souder femelle tube gaz

Flangia femmina a saldare per tubo gas

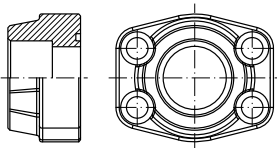

SERIE	Ø INNER Ø INT.	SIZE TAMAÑO	Part nº Referencia	€
3000 PSI	21.6	1/2"	<b>BBSG308216</b>	<b>10,83</b>
3000 PSI	17.5	1/2"	<b>BBSG308175</b>	<b>28,14</b>
3000 PSI	27.2	3/4"	<b>BBSG312272</b>	<b>13,21</b>
3000 PSI	34	1"	<b>BBSG316340</b>	<b>15,22</b>
3000 PSI	42.8	1"1/4	<b>BBSG320428</b>	<b>20,16</b>
3000 PSI	48.6	1"1/2	<b>BBSG324486</b>	<b>27,04</b>
3000 PSI	61	2"	<b>BBSG332610</b>	<b>30,51</b>
3000 PSI	76.6	2"1/2	<b>BBSG340766</b>	<b>48,90</b>
3000 PSI	90.5	3"	<b>BBSG348905</b>	<b>42,26</b>
3000 PSI	103	3"1/2	<b>BBSG3561030</b>	<b>60,10</b>
3000 PSI	115.5	4"	<b>BBSG341155</b>	<b>110,00</b>
6000 PSI	17.5	1/2"	<b>BBSG608175</b>	<b>15,76</b>
6000 PSI	21.6	1/2"	<b>BBSG608216</b>	<b>15,76</b>
6000 PSI	27.2	3/4"	<b>BBSG612272</b>	<b>21,09</b>
6000 PSI	34	1"	<b>BBSG621612</b>	<b>25,72</b>
6000 PSI	42.8	1"1/4	<b>BBSG620428</b>	<b>36,69</b>
6000 PSI	48.6	1"1/2	<b>BBSG624486</b>	<b>61,10</b>
6000 PSI	61	2"	<b>BBSG632610</b>	<b>88,37</b>

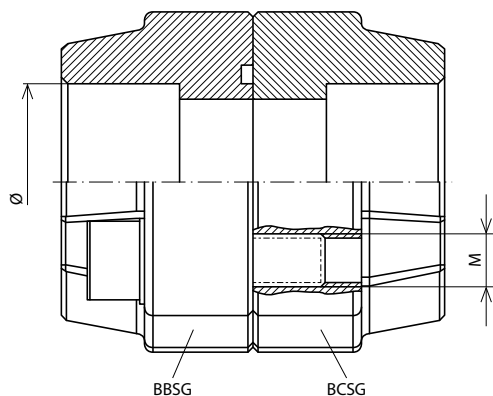

## Contrabrida soldable hembra tubo gas

Welding female counter-flange for gas tube

Contre-bride à souder femelle tube gaz

Controflangia femmina a saldare per tubo gas

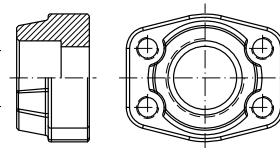

SERIE	Ø INNER Ø INT.	SIZE TAMAÑO	Part nº Referencia	€
3000 PSI	21.6	1/2"	<b>BCSG308216</b>	<b>13,98</b>
3000 PSI	17.5	1/2"	<b>BCSG308175</b>	<b>11,59</b>
3000 PSI	27.2	3/4"	<b>BCSG312272</b>	<b>13,21</b>
3000 PSI	34	1"	<b>BCSG316340</b>	<b>15,22</b>
3000 PSI	42.8	1"1/4	<b>BCSG320428</b>	<b>20,16</b>
3000 PSI	48.6	1"1/2	<b>BCSG324486</b>	<b>27,04</b>
3000 PSI	61	2"	<b>BCSG332610</b>	<b>30,51</b>
3000 PSI	76.6	2"1/2	<b>BCSG340766</b>	<b>35,07</b>
3000 PSI	90.5	3"	<b>BCSG348905</b>	<b>55,74</b>
3000 PSI	103	3"1/2	<b>BCSG3561030</b>	<b>60,10</b>
3000 PSI	115.5	4"	<b>BCSG3641155</b>	<b>64,19</b>
6000 PSI	21.6	1/2"	<b>BCSG608216</b>	<b>15,76</b>
6000 PSI	27.2	3/4"	<b>BCSG612272</b>	<b>21,09</b>
6000 PSI	34	1"	<b>BCSG616340</b>	<b>25,72</b>
6000 PSI	42.8	1"1/4	<b>BCSG620428</b>	<b>36,69</b>
6000 PSI	48.6	1"1/2	<b>BCSG624486</b>	<b>61,10</b>
6000 PSI	61	2"	<b>BCSG632610</b>	<b>88,37</b>

## Brida codo 90° soldable hembra tubo gas

90° welding female flange for gas tube

Bride 90° à souder femelle tube gaz

Flangia a 90° femmina a saldare per tubo gas

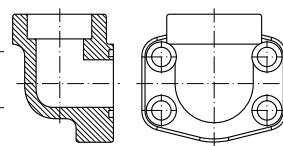

SERIE	Ø INNER Ø INT.	SIZE TAMAÑO	Part nº Referencia	€
3000 PSI	21.6	1/2"	<b>B90SG308216</b>	<b>40,05</b>
3000 PSI	17.5	1/2"	<b>B90SG308175</b>	<b>40,05</b>
3000 PSI	27.2	3/4"	<b>B90SG312272</b>	<b>43,20</b>
3000 PSI	34	1"	<b>B90SG316340</b>	<b>47,91</b>
3000 PSI	42.8	1"1/4	<b>B90SG320428</b>	<b>42,26</b>
3000 PSI	48.6	1"1/2	<b>B90SG324486</b>	<b>51,76</b>
3000 PSI	61	2"	<b>B90SG332610</b>	<b>63,04</b>
6000 PSI	21.6	1/2"	<b>B90SG608216</b>	<b>43,20</b>
6000 PSI	17.5	1/2"	<b>B90SG608175</b>	<b>43,20</b>
6000 PSI	27.2	3/4"	<b>B90SG612272</b>	<b>36,31</b>
6000 PSI	34	1"	<b>B90SG616340</b>	<b>42,26</b>
6000 PSI	42.8	1"1/4	<b>B90SG620428</b>	<b>68,31</b>
6000 PSI	48.6	1"1/2	<b>B90SG624486</b>	<b>83,22</b>

# Bridas SAE

SAE Flanges  
Brides de fixation SAE  
Flange SAE

## Brida soldable hembra tubo métrico

Female welding flange for metric tube

Bride à souder femelle tube métrique

Flangia femmina a saldare per tubo Metrico

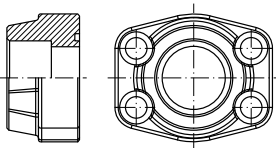

SERIE	Ø INNER Ø INT.	SIZE TAMAÑO	Part nº Referencia	€
3000 PSI	20.3	1/2"	<b>BBSM308203</b>	<b>18,42</b>
3000 PSI	25.3	3/4"	<b>BBSM312253</b>	<b>14,52</b>
3000 PSI	30.3	1"	<b>BBSM316303</b>	<b>17,00</b>
3000 PSI	38.3	1 1/4"	<b>BBSM320383</b>	<b>19,39</b>
3000 PSI	50.5	1 1/2"	<b>BBSM324505</b>	<b>24,87</b>
6000 PSI	20.3	1/2"	<b>BBSM608203</b>	<b>20,81</b>
6000 PSI	25.3	3/4"	<b>BBSM612253</b>	<b>22,42</b>
6000 PSI	30.3	1"	<b>BBSM616303</b>	<b>20,01</b>
6000 PSI	38.3	1 1/4"	<b>BBSM620383</b>	<b>27,96</b>
6000 PSI	50.5	1 1/2"	<b>BBSM624505</b>	<b>41,64</b>

## Brida codo 90° soldable hembra tubo métrico

90° female welding flange for metric tube

Bride 90° à souder femelle tube métrique

Flangia a 90° femmina a saldare per tubo Metrico

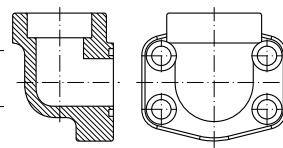

SERIE	Ø INNER Ø INT.	SIZE TAMAÑO	Part nº Referencia	€
3000 PSI	20.3	1/2"	<b>B90SM308203</b>	<b>38,40</b>
3000 PSI	25.3	3/4"	<b>B90SM312253</b>	<b>44,17</b>
3000 PSI	30.3	1"	<b>B90SM316303</b>	<b>47,25</b>
3000 PSI	38.3	1 1/4"	<b>B90SM320383</b>	<b>60,44</b>
3000 PSI	50.5	1 1/2"	<b>B90SM324505</b>	<b>91,89</b>
6000 PSI	20.3	1/2"	<b>B90SM608203</b>	<b>44,75</b>
6000 PSI	25.3	3/4"	<b>B90SM612253</b>	<b>45,23</b>
6000 PSI	30.3	1"	<b>B90SM616303</b>	<b>42,26</b>
6000 PSI	38.3	1 1/4"	<b>B90SM620383</b>	<b>51,76</b>
6000 PSI	50.3	1 1/2"	<b>B90SM624503</b>	<b>63,04</b>

## Contrabrida soldable hembra tubo métrico

Female welding counter-flange for metric tube

Contre-bride à souder femelle tube métrique

Controflangia femmina a saldare per tubo  
Metrico

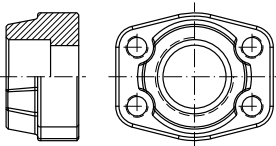

SERIE	Ø INNER Ø INT.	SIZE TAMAÑO	Part nº Referencia	€
3000 PSI	20.3	1/2"	<b>BCSM308203</b>	<b>18,42</b>
3000 PSI	25.3	3/4"	<b>BCSM312253</b>	<b>14,52</b>
3000 PSI	30.3	1"	<b>BCSM316303</b>	<b>17,00</b>
3000 PSI	38.3	1 1/4"	<b>BCSM320383</b>	<b>19,39</b>
6000 PSI	20.3	1/2"	<b>BCSM608203</b>	<b>15,76</b>
6000 PSI	25.3	3/4"	<b>BCSM612253</b>	<b>17,00</b>
6000 PSI	30.3	1"	<b>BCSM616303</b>	<b>20,01</b>
6000 PSI	38.3	1 1/4"	<b>BCSM620383</b>	<b>27,96</b>
6000 PSI	50.5	1 1/2"	<b>BCSM624505</b>	<b>41,64</b>

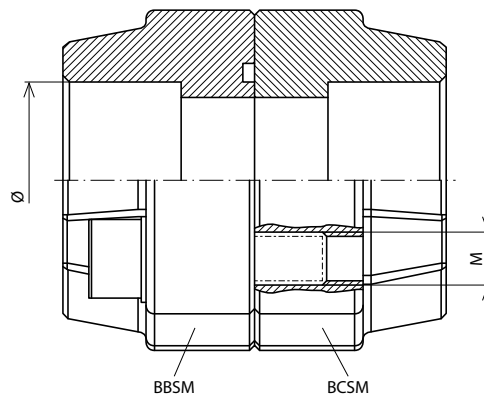

# Bridas SAE

SAE Flanges  
Brides de fixation SAE  
Flange SAE

Tube Pipe

Pipe Fittings, DIN 2353  
/ Flare fittings, JIC 37°

SAE Flanges

Tube Clamps

Machines for  
processing rigid pipes

## Brida soldable macho tubo gas

Male welding flange for gas tube

Bride à souder mâle tube gaz

Flangia a saldare maschio tubo gas

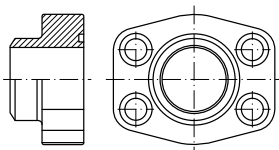

SERIE	Ø OUTER Ø EXT.	SIZE TAMAÑO	Part nº Referencia	€
3000 PSI	21.5	1/2"	<b>BMSG308215</b>	<b>13,98</b>
3000 PSI	17.5	1/2"	<b>BMSG308175</b>	<b>13,98</b>
3000 PSI	28	3/4"	<b>BMSG312280</b>	<b>19,21</b>
3000 PSI	34	1"	<b>BMSG316340</b>	<b>17,00</b>
3000 PSI	42.8	1 1/4"	<b>BMSG320428</b>	<b>25,61</b>
3000 PSI	48.6	1 1/2"	<b>BMSG324486</b>	<b>32,83</b>
3000 PSI	61	2"	<b>BMSG332610</b>	<b>29,74</b>
3000 PSI	77	2 1/2"	<b>BMSG340770</b>	<b>35,07</b>
3000 PSI	92	3"	<b>BMSG348920</b>	<b>42,26</b>
3000 PSI	103	3 1/2"	<b>BMSG356103</b>	<b>60,10</b>
6000 PSI	21.5	1/2"	<b>BMSG608215</b>	<b>15,76</b>
6000 PSI	17.5	1/2"	<b>BMSG608175</b>	<b>15,76</b>
6000 PSI	28	3/4"	<b>BMSG612280</b>	<b>22,42</b>
6000 PSI	34	1"	<b>BMSG616340</b>	<b>26,43</b>
6000 PSI	42.8	1 1/4"	<b>BMSG620428</b>	<b>36,92</b>
6000 PSI	48.6	1 1/2"	<b>BMSG624486</b>	<b>54,95</b>
6000 PSI	61	2"	<b>BMSG632610</b>	<b>54,85</b>

## Contrabrida soldable macho tubo gas

Male welding counter-flange for gas tube

Contre-bride à souder mâle tube gaz

Controflangia a saldare maschio tubo gas

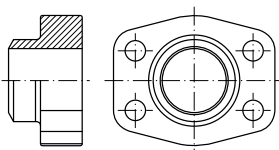

SERIE	Ø OUTER Ø EXT.	SIZE TAMAÑO	Part nº Referencia	€
3000 PSI	21.5	1/2"	<b>BCMSG308215</b>	<b>13,98</b>
3000 PSI	17.5	1/2"	<b>BCMSG308175</b>	<b>13,98</b>
3000 PSI	28	3/4"	<b>BCMSG312280</b>	<b>19,21</b>
3000 PSI	34	1"	<b>BCMSG316340</b>	<b>22,42</b>
3000 PSI	42.8	1 1/4"	<b>BCMSG320428</b>	<b>25,61</b>
3000 PSI	48.6	1 1/2"	<b>BCMSG324486</b>	<b>24,87</b>
3000 PSI	61	2"	<b>BCMSG332610</b>	<b>29,74</b>
3000 PSI	77	2 1/2"	<b>BCMSG340770</b>	<b>46,32</b>
3000 PSI	92	3"	<b>BCMSG348920</b>	<b>42,26</b>
3000 PSI	103	3 1/2"	<b>BCMSG561030</b>	<b>60,10</b>
3000 PSI	115.5	4"	<b>BCMSG3641155</b>	<b>64,19</b>
6000 PSI	21.5	1/2"	<b>BCMSG608215</b>	<b>15,76</b>
6000 PSI	17.5	1/2"	<b>BCMSG608175</b>	<b>15,76</b>
6000 PSI	28	3/4"	<b>BCMSG612280</b>	<b>17,00</b>
6000 PSI	34	1"	<b>BCMSG616340</b>	<b>26,42</b>
6000 PSI	42.8	1 1/4"	<b>BCMSG620428</b>	<b>27,96</b>
6000 PSI	48.6	1 1/2"	<b>BCMSG624486</b>	<b>41,64</b>
6000 PSI	61	2"	<b>BCMSG632610</b>	<b>54,85</b>

## Brida soldable macho tubo métrico

Male welding flange for metric tube

Bride à souder mâle tube métrique

Flangia a saldare maschio tubo Metrico

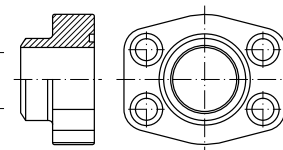

SERIE	Ø OUTER Ø EXT.	SIZE TAMAÑO	Part nº Referencia	€
3000 PSI	25	3/4"	<b>BMSM31225</b>	<b>19,21</b>
3000 PSI	30	1"	<b>BMSM31630</b>	<b>22,42</b>
3000 PSI	38	1 1/4"	<b>BMSM32038</b>	<b>25,61</b>
3000 PSI	42	1 1/2"	<b>BMSM32442</b>	<b>32,83</b>
3000 PSI	61	2"	<b>BMSM33261</b>	<b>29,74</b>
3000 PSI	49	2"	<b>BMSM33249</b>	<b>29,74</b>
3000 PSI	77	3"	<b>BMSM34877</b>	<b>42,26</b>
3000 PSI	77	3 1/2"	<b>BMSM35677</b>	<b>79,30</b>
3000 PSI	90	3 1/2"	<b>BMSM35690</b>	<b>79,30</b>
3000 PSI	77	4"	<b>BMSM36477</b>	<b>64,19</b>
3000 PSI	90	4"	<b>BMSM36490</b>	<b>64,19</b>
6000 PSI	20	1/2"	<b>BMSM60820</b>	<b>15,76</b>
6000 PSI	20	3/4"	<b>BMSM61220</b>	<b>22,42</b>
6000 PSI	25	3/4"	<b>BMSM61225</b>	<b>22,42</b>
6000 PSI	25	1"	<b>BMSM61625</b>	<b>26,43</b>
6000 PSI	30	1"	<b>BMSM61630</b>	<b>26,43</b>
6000 PSI	38	1 1/4"	<b>BMSM62038</b>	<b>36,92</b>
6000 PSI	38	1 1/2"	<b>BMSM62438</b>	<b>54,95</b>
6000 PSI	61	2"	<b>BMSM63261</b>	<b>54,85</b>

## Contrabrida soldable macho tubo métrico

Male welding counter-flange for metric tube

Contre-bride à souder mâle tube métrique

Controflangia a saldare maschio tubo Metrico

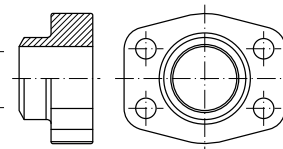

SERIE	Ø OUTER Ø EXT.	SIZE TAMAÑO	Part nº Referencia	€
3000 PSI	25	3/4"	<b>BCMSM31225</b>	<b>14,52</b>
3000 PSI	30	1"	<b>BCMSM31630</b>	<b>17,00</b>
3000 PSI	38	1 1/4"	<b>BCMSM32038</b>	<b>25,61</b>
3000 PSI	42	1 1/2"	<b>BCMSM32442</b>	<b>24,87</b>
3000 PSI	49	1 1/2"	<b>BCMSM32449</b>	<b>32,83</b>
3000 PSI	61	2"	<b>BCMSM33261</b>	<b>29,74</b>
3000 PSI	49	2"	<b>BCMSM33249</b>	<b>39,26</b>
3000 PSI	77	2 1/2"	<b>BCMSM34077</b>	<b>35,07</b>
3000 PSI	77	3"	<b>BCMSM34877</b>	<b>42,26</b>
3000 PSI	77	3 1/2"	<b>BCMSM35677</b>	<b>60,10</b>
3000 PSI	90	3 1/2"	<b>BCMSM35690</b>	<b>60,10</b>
3000 PSI	90	4"	<b>BCMSM36490</b>	<b>64,19</b>
6000 PSI	20	1/2"	<b>BCMSM60820</b>	<b>15,76</b>
6000 PSI	20	3/4"	<b>BCMSM61220</b>	<b>22,42</b>
6000 PSI	25	3/4"	<b>BCMSM61225</b>	<b>22,42</b>
6000 PSI	25	1"	<b>BCMSM61625</b>	<b>26,43</b>
6000 PSI	30	1"	<b>BCMSM61630</b>	<b>26,43</b>
6000 PSI	38	1 1/4"	<b>BCMSM62038</b>	<b>36,92</b>
6000 PSI	38	1 1/2"	<b>BCMSM62438</b>	<b>54,95</b>
6000 PSI	61	2"	<b>BCMSM63261</b>	<b>54,85</b>

# Bridas SAE

SAE Flanges  
Brides de fixation SAE  
Flange SAE

## Brida soldable macho serie L tubo métrico

Male welding flange L serie for metric tube

Bride à souder mâle série L tube métrique

Flangia a saldare maschio serie L tubo Metrico

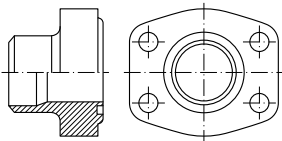

SERIE	Ø OUTER Ø EXT.	SIZE TAMAÑO	Part nº Referencia	€
3000 PSI	20	1/2"	<b>BMSLM30820</b>	<b>18,42</b>
3000 PSI	22	1/2"	<b>BMSLM30822</b>	<b>18,42</b>
3000 PSI	28	3/4"	<b>BMSLM31228</b>	<b>19,21</b>
3000 PSI	35	1"	<b>BMSLM31635</b>	<b>22,42</b>
3000 PSI	43	1"1/4	<b>BMSLM32043</b>	<b>25,61</b>
3000 PSI	49	1"1/2	<b>BMSLM32449</b>	<b>32,83</b>
3000 PSI	61	2"	<b>BMSLM33261</b>	<b>39,26</b>
3000 PSI	77	2"1/2	<b>BMSLM34077</b>	<b>35,07</b>
3000 PSI	90	3"	<b>BMSLM34890</b>	<b>55,74</b>
3000 PSI	115	4"	<b>BMSLM364115</b>	<b>64,19</b>

## Contrabrida soldable macho serie L tubo métrico

Male welding counter-flange L serie for metric tube

Contre-bride à souder mâle série L tube métrique

Controflangia a saldare maschio serie L tubo Metrico

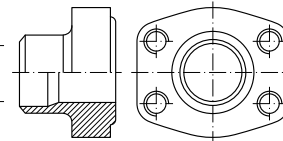

SERIE	Ø OUTER Ø EXT.	SIZE TAMAÑO	Part nº Referencia	€
3000 PSI	20	1/2"	<b>BCMSLM30820</b>	<b>18,42</b>
3000 PSI	22	1/2"	<b>BCMSLM30822</b>	<b>18,42</b>
3000 PSI	28	3/4"	<b>BCMSLM31228</b>	<b>19,21</b>
3000 PSI	35	1"	<b>BCMSLM31635</b>	<b>22,42</b>
3000 PSI	43	1"1/4	<b>BCMSLM32043</b>	<b>25,61</b>
3000 PSI	49	1"1/2	<b>BCMSLM32449</b>	<b>32,83</b>
3000 PSI	61	2"	<b>BCMSLM33261</b>	<b>29,74</b>
3000 PSI	77	2"1/2	<b>BCMSLM34077</b>	<b>35,07</b>
3000 PSI	90	3"	<b>BCMSLM34890</b>	<b>42,26</b>
3000 PSI	115	4"	<b>BCMSLM364115</b>	<b>64,19</b>

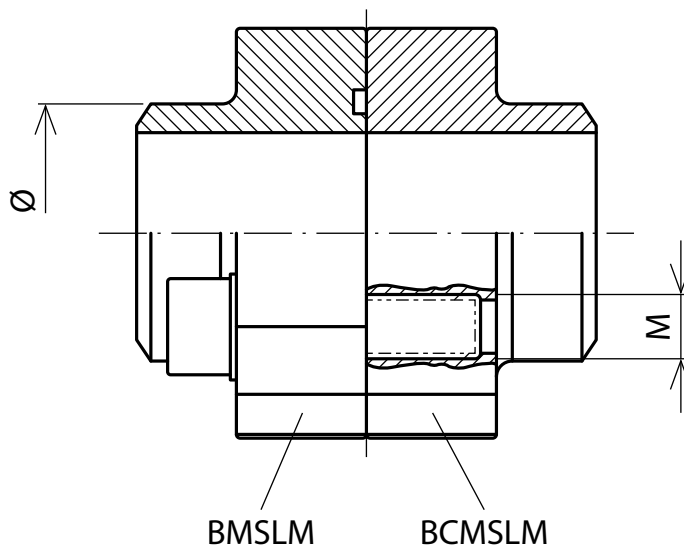

# Bridas SAE

SAE Flanges  
Brides de fixation SAE  
Flange SAE

## Tornillos para bridas SAE

Screws for SAE flanges

Vis pour brides SAE

Vite per flangia SAE



THREAD ROSCA	SIZE TAMAÑO	Part nº Referencia	€
M8X30	3000-6000 PSI 1/2"	<b>TB8X30</b>	<b>0,17</b>
M10X35	3000 PSI 3/4"-1"	<b>TB10X35</b>	<b>0,38</b>
M10X40	3000 PSI 1" 1/4 - 6000 PSI 3/4"	<b>TB10X40</b>	<b>0,41</b>
M12X45	3000 PSI 1"1/2-2"-2"1/2-6000 PSI 1"	<b>TB12X45</b>	<b>0,60</b>
M14X45	6000 PSI 1"1/4	<b>TB14X45</b>	<b>0,89</b>
M16X50	3000 PSI 3"-3" 1/2-4"- 6000 PSI 1" 1/2	<b>TB16X50</b>	<b>1,31</b>
M20X70	6000 PSI 2"	<b>TB20X70</b>	<b>2,29</b>

## Juntas para bridas SAE 3000/6000 PSI

Seals for 3000/6000 PSI flange

Joints pour bride série 3000/6000

Guarnizioni per flangia SAE 3000/6000 PSI



Ø OUTER Ø EXT.	Ø INNER Ø INT.	SIZE TAMAÑO	Part nº Referencia	€
25.40	17.02	1/2"	<b>JBR08</b>	*
31.72	23.36	3/4"	<b>JBR12</b>	*
39.62	31.24	1"	<b>JBR16</b>	*
44.45	36.07	1"1/4	<b>JBR20</b>	*
53.98	45.34	1"1/2	<b>JBR24</b>	*
63.50	54.86	2"	<b>JBR32</b>	*

\*Ver precios en p.58 / \*See prices page 58 / \*Voir les prix page 58 / \*Vedere prezzi p.58

## Juntas tóricas para bridas SAE 3000/6000 PSI

O´rings for 3000/6000 PSI flange

O´rings pour bride série 3000/6000 PSI

O´rings per flangia SAE 3000/6000 PSI



Ø INNER Ø INT.	SIZE TAMAÑO	Part nº Referencia	€
18.64	1/2"	<b>18.64X3.53</b>	*
24.99	3/4"	<b>24.99X3.53</b>	*
32.92	1"	<b>32.92X3.53</b>	*
37.70	1"1/4	<b>37.70X3.53</b>	*
47.22	1"1/2	<b>47.22X3.53</b>	*
56.74	2"	<b>56.74X3.53</b>	*

\*Ver precios en p.58 / \*See prices page 58 / \*Voir les prix page 58 / \*Vedere prezzi p.58

# Bridas SAE

SAE Flanges  
Bridas de fixation SAE  
Flange SAE

## Brida roscada macho BSP

BSP Male threaded flange

Bridas tarauées mâle BSP

Flangia maschio filettata BSP

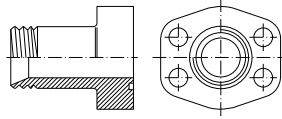

SERIE	THREAD ROSCA	SIZE TAMAÑO	Part nº Referencia	€
3000 PSI	3/8" BSP	1/2"	<b>BMRG30806</b>	<b>31,22</b>
3000 PSI	1/2" BSP	1/2"	<b>BMRG30808</b>	<b>27,21</b>
3000 PSI	3/4" BSP	3/4"	<b>BMRG31212</b>	<b>26,11</b>
3000 PSI	1/2" BSP	3/4"	<b>BMRG31208</b>	<b>26,11</b>
3000 PSI	1" BSP	1"	<b>BMRG31616</b>	<b>17,75</b>
3000 PSI	3/4" BSP	1"	<b>BMRG31612</b>	<b>17,75</b>
3000 PSI	1"1/4 BSP	1"1/4	<b>BMRG32020</b>	<b>22,14</b>
3000 PSI	1" BSP	1"1/4	<b>BMRG32016</b>	<b>22,14</b>
3000 PSI	1"1/2 BSP	1"1/2	<b>BMRG32424</b>	<b>29,85</b>
3000 PSI	1"1/4 BSP	1"1/2	<b>BMRG32420</b>	<b>29,85</b>
6000 PSI	1/2" BSP	1/2"	<b>BMRG60808</b>	<b>29,61</b>
6000 PSI	3/8" BSP	1/2"	<b>BMRG60806</b>	<b>32,01</b>
6000 PSI	3/4" BSP	3/4"	<b>BMRG61212</b>	<b>24,47</b>
6000 PSI	1/2" BSP	3/4"	<b>BMRG61208</b>	<b>39,23</b>
6000 PSI	1" BSP	1"	<b>BMRG61616</b>	<b>29,85</b>
6000 PSI	3/4" BSP	1"	<b>BMRG61612</b>	<b>29,85</b>
6000 PSI	1"1/4 BSP	1"1/4	<b>BMRG62020</b>	<b>36,69</b>
6000 PSI	1" BSP	1"1/4	<b>BMRG62016</b>	<b>42,58</b>
6000 PSI	1"1/2 BSP	1"1/2	<b>BMRG62424</b>	<b>46,43</b>
6000 PSI	1"1/4 BSP	1"1/2	<b>BMRG62420</b>	<b>51,14</b>

## Brida roscada macho métrico

Metric Male threaded flange

Bridas tarauées mâle Métrica

Flangia maschio filettata Metrica

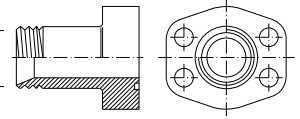

SERIE	THREAD ROSCA	SIZE TAMAÑO	Part nº Referencia	€
3000 PSI	M22x1,5	1/2"	<b>BMRM30822</b>	<b>30,84</b>
3000 PSI	M30x2	3/4"	<b>BMRM31230</b>	<b>35,38</b>
3000 PSI	M36x2	1"	<b>BMRM31636</b>	<b>41,74</b>
3000 PSI	M45x2	1"1/4	<b>BMRM32045</b>	<b>49,89</b>
3000 PSI	M52x2	1"1/2	<b>BMRM32452</b>	<b>59,86</b>
6000 PSI	M24x1,5	1/2"	<b>BMRM60824</b>	<b>33,56</b>
6000 PSI	M36X2	3/4"	<b>BMRM61236</b>	<b>40,81</b>
6000 PSI	M42x2	1"	<b>BMRM61642</b>	<b>49,89</b>
6000 PSI	M52x2	1"1/4	<b>BMRM62052</b>	<b>58,74</b>
6000 PSI	M52x2	1"1/2	<b>BMRM62452</b>	<b>69,40</b>

## Bridas ciegas

Blind flanges

Bridas avec obturateur fermé

Flangia cieche

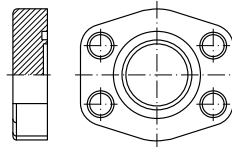

SERIE	SIZE TAMAÑO	Part nº Referencia	€
3000 PSI	1/2"	<b>BBC308</b>	<b>12,28</b>
3000 PSI	3/4"	<b>BBC312</b>	<b>10,89</b>
3000 PSI	1"	<b>BBC316</b>	<b>11,67</b>
3000 PSI	1"1/4	<b>BBC320</b>	<b>13,36</b>
3000 PSI	1"1/2	<b>BBC324</b>	<b>13,60</b>
3000 PSI	2"	<b>BBC332</b>	<b>28,74</b>
3000 PSI	2"1/2	<b>BBC340</b>	<b>24,35</b>
3000 PSI	3"	<b>BBC348</b>	<b>29,12</b>
3000 PSI	3"1/2	<b>BBC356</b>	<b>34,45</b>
3000 PSI	4"	<b>BBC364</b>	<b>36,77</b>
3000 PSI	5"	<b>BBC380</b>	<b>78,18</b>
6000 PSI	1/2"	<b>BBC608</b>	<b>12,13</b>
6000 PSI	3/4"	<b>BBC612</b>	<b>12,75</b>
6000 PSI	1"	<b>BBC616</b>	<b>14,52</b>
6000 PSI	1"1/4	<b>BBC620</b>	<b>17,23</b>
6000 PSI	1"1/2	<b>BBC624</b>	<b>20,24</b>
6000 PSI	2"	<b>BBC632</b>	<b>32,06</b>

## Contrabridas ciegas

Blind counter-flanges

Contre-bridas avec obturateur fermé

Controflangia cieche

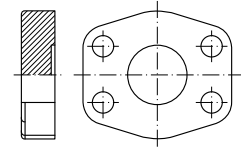

SERIE	SIZE TAMAÑO	Part nº Referencia	€
3000 PSI	1/2"	<b>BCC308</b>	<b>10,35</b>
3000 PSI	3/4"	<b>BCC312</b>	<b>10,89</b>
3000 PSI	1"	<b>BCC316</b>	<b>12,75</b>
3000 PSI	1"1/4	<b>BCC320</b>	<b>17,63</b>
3000 PSI	1"1/2	<b>BCC324</b>	<b>20,81</b>
3000 PSI	2"	<b>BCC332</b>	<b>16,07</b>
3000 PSI	2"1/2	<b>BCC340</b>	<b>24,35</b>
3000 PSI	3"	<b>BCC348</b>	<b>29,12</b>
3000 PSI	3"1/2	<b>BCC356</b>	<b>34,45</b>
3000 PSI	4"	<b>BCC364</b>	<b>48,52</b>
3000 PSI	5"	<b>BCC380</b>	<b>78,18</b>
6000 PSI	1/2"	<b>BCC608</b>	<b>12,13</b>
6000 PSI	3/4"	<b>BCC612</b>	<b>12,75</b>
6000 PSI	1"	<b>BCC616</b>	<b>14,52</b>
6000 PSI	1"1/4	<b>BCC620</b>	<b>17,23</b>
6000 PSI	1"1/2	<b>BCC624</b>	<b>20,24</b>
6000 PSI	2"	<b>BCC632</b>	<b>32,06</b>

# Bridas SAE

SAE Flanges  
Brides de fixation SAE  
Flange SAE

## Brida partida pasante

SAE Split flange

Demi-bride SAE passage total

Semiflanguia SAE

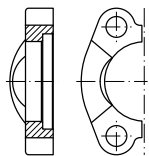

SERIE	SIZE TAMAÑO	Part nº Referencia	€
3000 PSI	1/2"	<b>BBP308</b>	*
3000 PSI	3/4"	<b>BBP312</b>	*
3000 PSI	1"	<b>BBP316</b>	*
3000 PSI	1"1/4	<b>BBP320</b>	*
3000 PSI	1"1/2	<b>BBP324</b>	*
3000 PSI	2"	<b>BBP332</b>	*
3000 PSI	2"1/2	<b>BBP340</b>	*
3000 PSI	3"	<b>BBP348</b>	*
3000 PSI	3"1/2	<b>BBP356</b>	*
3000 PSI	4"	<b>BBP364</b>	*
6000 PSI	1/2"	<b>BBP608</b>	*
6000 PSI	3/4"	<b>BBP612</b>	*
6000 PSI	1"	<b>BBP616</b>	*
6000 PSI	1"1/4	<b>BBP620</b>	*
6000 PSI	1"1/2	<b>BBP624</b>	*
6000 PSI	2"	<b>BBP632</b>	*

\*Ver precios en p.58 (Conexiones Standard) / \*See prices in p.58 (Standard Serie Fittings) / \*Prix à la p.58 (Emboutis Série Standard) / \*Vedere prezzi p.58 (Raccordi Serie Standard)

## Brida entera pasante

SAE Flange

Bride SAE monobloc passage total

Flangia monoblocco SAE

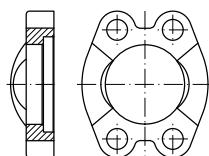

SERIE	SIZE TAMAÑO	Part nº Referencia	€
3000 PSI	1/2"	<b>BBE308</b>	*
3000 PSI	3/4"	<b>BBE312</b>	*
3000 PSI	1"	<b>BBE316</b>	*
3000 PSI	1"1/4	<b>BBE320</b>	*
3000 PSI	1"1/2	<b>BBE324</b>	*
3000 PSI	2"	<b>BBE332</b>	*
3000 PSI	2"1/2	<b>BBE340</b>	*
3000 PSI	3"	<b>BBE348</b>	*
3000 PSI	3"1/2	<b>BBE356</b>	*
3000 PSI	4"	<b>BBE364</b>	*
3000 PSI	5"	<b>BBE380</b>	*
6000 PSI	1/2"	<b>BBE608</b>	*
6000 PSI	3/4"	<b>BBE612</b>	*
6000 PSI	1"	<b>BBE616</b>	*
6000 PSI	1"1/4	<b>BBE620</b>	*
6000 PSI	1"1/2	<b>BBE624</b>	*
6000 PSI	2"	<b>BBE632</b>	*

\*Ver precios en p.58 (Conexiones Standard) / \*See prices in p.58 (Standard Serie Fittings) / \*Prix à la p.58 (Emboutis Série Standard) / \*Vedere prezzi p.58 (Raccordi Serie Standard)

## Contrabrida rosca Métrica

Metric threaded counter-flange

Contre-bride métrique

Controflangia filettata Metrica

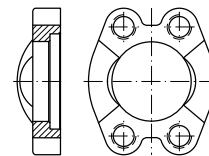

SERIE	SIZE TAMAÑO	Part nº Referencia	€
3000 PSI	1/2"	<b>BCE308</b>	<b>12,36</b>
3000 PSI	3/4"	<b>BCE312</b>	<b>13,25</b>
3000 PSI	1"	<b>BCE316</b>	<b>15,24</b>
3000 PSI	1"1/4	<b>BCE320</b>	<b>17,96</b>
3000 PSI	1"1/2	<b>BCE324</b>	<b>20,87</b>
3000 PSI	2"	<b>BCE332</b>	<b>38,10</b>
3000 PSI	2"1/2	<b>BCE340</b>	<b>50,02</b>
3000 PSI	3"	<b>BCE348</b>	<b>72,25</b>
3000 PSI	3"1/2	<b>BCE356</b>	<b>107,17</b>
3000 PSI	4"	<b>BCE364</b>	<b>134,40</b>
3000 PSI	5"	<b>BCE380</b>	<b>163,36</b>
6000 PSI	1/2"	<b>BCE608</b>	<b>14,18</b>
6000 PSI	3/4"	<b>BCE612</b>	<b>15,24</b>
6000 PSI	1"	<b>BCE616</b>	<b>19,98</b>
6000 PSI	1"1/4	<b>BCE620</b>	<b>28,86</b>
6000 PSI	1"1/2	<b>BCE624</b>	<b>58,37</b>
6000 PSI	2"	<b>BCE632</b>	<b>81,69</b>

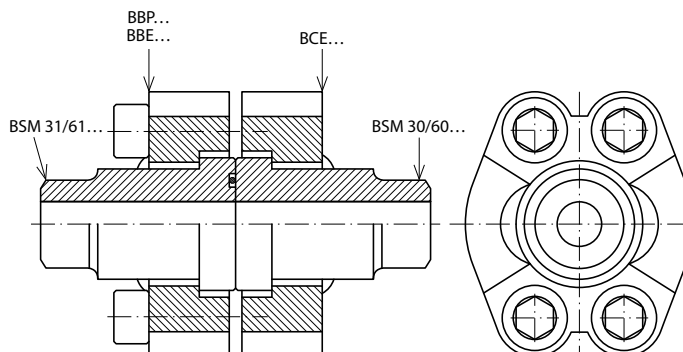

# Bridas SAE

SAE Flanges  
Brides de fixation SAE  
Flange SAE

## Brida cono soldable tubo métrico

Flange welding adaptor for metric tube

Bride collet à souder tube métrique

Flangia adattatore a saldare per tubo Metrico

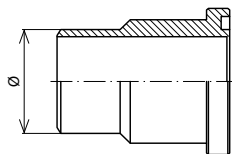

SERIE	Ø OUTER Ø EXT.	SIZE TAMAÑO	Part nº Referencia	€
3000 PSI	16	1/2"	<b>BSM310816</b>	<b>13,36</b>
3000 PSI	25	3/4"	<b>BSM311225</b>	<b>6,45</b>
3000 PSI	30	1"	<b>BSM311630</b>	<b>9,05</b>
3000 PSI	38	1"1/4	<b>BSM3132038</b>	<b>10,31</b>
3000 PSI	45	1"1/2	<b>BSM312445</b>	<b>12,91</b>
3000 PSI	60	2"	<b>BSM313260</b>	<b>15,51</b>
3000 PSI	70	2"1/2	<b>BSM314070</b>	<b>33,91</b>
3000 PSI	80	3"	<b>BSM314880</b>	<b>60,45</b>
3000 PSI	100	3"1/2	<b>BSM3156100</b>	<b>77,94</b>
3000 PSI	114.3	4"	<b>BSM31641143</b>	<b>87,45</b>
3000 PSI	139.7	5"	<b>BSM31801397</b>	<b>124,87</b>
6000 PSI	16	1/2"	<b>BSM610816</b>	<b>6,45</b>
6000 PSI	25	3/4"	<b>BSM611225</b>	<b>9,05</b>
6000 PSI	30	1"	<b>BSM611630</b>	<b>12,91</b>
6000 PSI	38	1"1/4	<b>BSM612038</b>	<b>15,51</b>
6000 PSI	45	1"1/2	<b>BSM612445</b>	<b>19,27</b>
6000 PSI	60	2"	<b>BSM613260</b>	<b>25,73</b>

## Contrabrida cono soldable tubo métrico

Counter-flange welding adaptor for metric tube

Contrebride collet à souder tube métrique

Controflangia adattatore a saldare per tubo Metrico

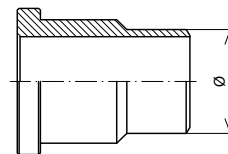

SERIE	Ø OUTER Ø EXT.	SIZE TAMAÑO	Part nº Referencia	€
3000 PSI	16	1/2"	<b>BSM300816</b>	<b>10,12</b>
3000 PSI	25	3/4"	<b>BSM301225</b>	<b>11,28</b>
3000 PSI	30	1"	<b>BSM301630</b>	<b>11,90</b>
3000 PSI	38	1"1/4	<b>BSM302038</b>	<b>15,45</b>
3000 PSI	45	1"1/2	<b>BSM302445</b>	<b>19,62</b>
3000 PSI	60	2"	<b>BSM303260</b>	<b>25,57</b>
3000 PSI	70	2"1/2	<b>BSM304070</b>	<b>33,91</b>
3000 PSI	80	3"	<b>BSM304880</b>	<b>45,81</b>
3000 PSI	100	3"1/2	<b>BSM3056100</b>	<b>77,94</b>
3000 PSI	114.3	4"	<b>BSM30641143</b>	<b>87,45</b>
3000 PSI	139.7	5"	<b>BSM30801397</b>	<b>107,61</b>
6000 PSI	16	1/2"	<b>BSM600816</b>	<b>10,74</b>
6000 PSI	25	3/4"	<b>BSM601225</b>	<b>13,67</b>
6000 PSI	30	1"	<b>BSM601630</b>	<b>15,45</b>
6000 PSI	38	1"1/4	<b>BSM602038</b>	<b>17,85</b>
6000 PSI	45	1"1/2	<b>BSM602445</b>	<b>22,63</b>
6000 PSI	60	2"	<b>BSM603260</b>	<b>37,47</b>

## Cono Cetop soldable exterior

Cetop welding adaptor

Collet Cetop à souder

Adattatore a saldare Cetop

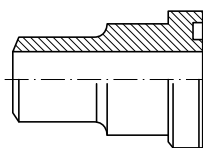

SERIE	Ø OUTER Ø EXT.	SIZE TAMAÑO	Part nº Referencia	€
3000 PSI	18	3/8"	<b>BCTS30618</b>	<b>8,81</b>
6000 PSI	18	3/8"	<b>BCTS60618</b>	<b>10,58</b>

## Bridas Cetop

Cetop flanges

Brides Cetop

Flangia Cetop

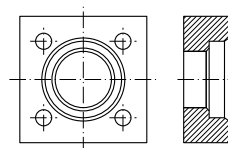

SERIE	Ø INNER Ø INT.	SIZE TAMAÑO	Part nº Referencia	€
3000 PSI	31	1/2"	<b>BCT30831</b>	<b>8,81</b>

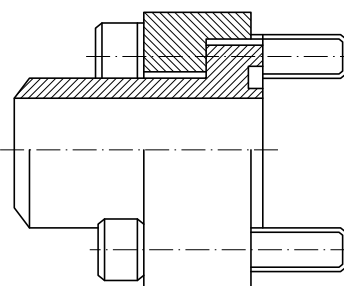
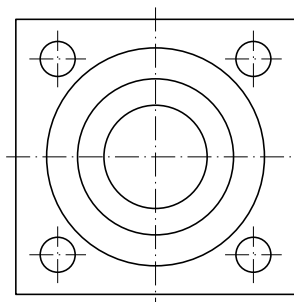

# Bridas SAE

SAE flanges  
Brides SAE  
Flangia SAE

## Características comunes

Common characteristics  
Données communes  
Caratteristiche comuni

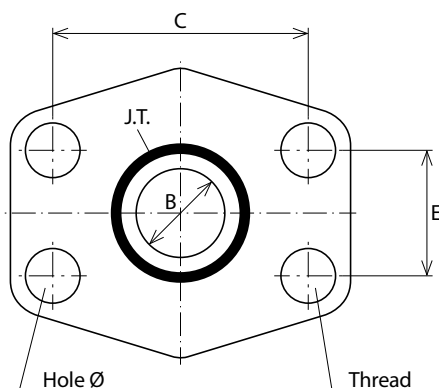

## Bridas 3000 PSI

Flanges 3000 PSI  
Brides 3000 PSI  
Flangia 3000 PSI

Tamaño Size Taille Misura	Max. pre. Max. pre. Max. pre.	B	C	E	O'ring NBR O'ring NBR O'ring NBR	Junta PU PU seal Joint PU Guarnizione in PU	Ø	Tornillo * Screw * Vis * Vite *	Rosca Thread Filetage Filetto
1/2"	345 bar	13	38,1	17,48	18,64 x 3,53	JBR08	9	TB8X30	M8
3/4"	345 bar	19	47,63	22,23	24,99 x 3,53	JBR12	11	TB10X35	M10
1"	345 bar	25	52,37	26,19	32,92 x 3,53	JBR16	11	TB10X35	M10
1 1/4"	276 bar	32	58,72	30,18	37,70 x 3,53	JBR20	11,5	TB10X40	M10
1 1/2"	207 bar	38	69,85	35,71	47,22 x 3,53	JBR24	13,5	TB12X45	M12
2"	207 bar	51	77,77	42,88	56,74 x 3,53	JBR32	13,5	TB12X45	M12
2 1/2"	172 bar	63	88,9	50,8	66,27 x 3,53		13,5	TB12X45	M12
3"	138 bar	73	106,38	61,93	85,32 x 3,53		17,5	TB16X50	M16
3 1/2"	34 bar	89	120,65	69,85	98,02 x 3,53		17,5	TB16X50	M16
4"	34 bar	99	130,18	77,77	110,72 x 3,53		17,5	TB16X50	M16

## Bridas 6000 PSI

Flanges 6000 PSI  
Brides 6000 PSI  
Flangia 6000 PSI

Tamaño Size Taille Misura	Max. pre. Max. pre. Max. pre.	B	C	E	O'ring NBR O'ring NBR O'ring NBR	Junta PU PU seal Joint PU Guarnizione PU	Ø	Tornillo * Screw * Vis * Vite *	Rosca Thread Filetage Filetto
1/2"	414 bar	13	40,49	18,24	18,64 x 3,53	JBR08	9	TB8X30	M8
3/4"	414 bar	19	50,8	23,8	24,99 x 3,53	JBR12	11	TB10X40	M10
1"	414 bar	25	57,15	27,76	32,92 x 3,53	JBR16	13	TB12X45	M12
1 1/4"	414 bar	32	66,68	31,75	37,70 x 3,53	JBR20	15	TB14X45	M14
1 1/2"	414 bar	38	79,38	36,5	47,22 x 3,53	JBR24	17	TB16X50	M16
2"	414 bar	51	98,82	44,45	56,74 x 3,53	JBR32	21	TB20X70	M20

\* Tornillos en acero carbono. Para tornillos en acero inoxidable, pedir ZTB...

Screws are in carbon steel. For Stainless Steel screws, ask for ZTB... part number.

Les vis sont en acier. Pour vis en acier inoxydable, veuillez demander les références ZTB ...

Le viti sono in acciaio al carbonio. Per viti in acciaio inox, ordinare con codice ZTB...

## Abrazaderas TrΔle

*TrΔle Clamps*

Colliers TrΔle

*Collari fissatubo TrΔle*

### Abrazaderas Serie ligera TrΔle

*Clamps for pipe - TrΔle*  
Colliers de fixation TrΔle  
*Collari Serie leggera TrΔle*

262

### Abrazaderas Serie doble TrΔle

*Clamps double Series - TrΔle*  
Colliers Serie double TrΔle  
*Collari Serie doppi TrΔle*

266

### Abrazaderas Serie pesada TrΔle

*Clamps heavy Series - TrΔle*  
Colliers Série lourde TrΔle  
*Collari Serie pesante TrΔle*

268

### Accesorios abrazaderas TrΔle

*Accessories for clamps - TrΔle*  
Accessoires colliers TrΔle  
*Accessori per collari TrΔle*

271

4

# Abrazaderas Serie ligera TrΔle

Clamps for pipe - TrΔle  
 Colliers de fixation TrΔle  
 Collari Serie leggera TrΔle

## ■ Completas / Light serie clamp / Colliers de fixation série légère / Collari fissatubo serie leggera

| 262



## ■ Componentes / Parts / Composants / Accessori

| 264



## ■ Accesorios / Accessories / Accessoires / Accessori

| 265



# Abrazaderas Serie doble TrΔle

Clamps double Series - TrΔle

Colliers Serie double TrΔle

Collari Serie doppi TrΔle

## ■ Completas / Double / Complets / Doppio

| 266



AZCFS

## ■ Componentes / Parts / Composants / Accessori

| 266



ADPIN



ADVTE



ADPS



ADC

## ■ Accesorios / Accessories / Accessori / Accessori

| 267



ADPA



ADPAG



ADVTA

# Abrazaderas Serie pesada TrΔle

Clamps heavy Series - TrΔle

Colliers Série lourde TrΔle

Collari Serie pesante TrΔle

## ■ Completas / Complete / Complètes / Completo

| 268



AZCPS

## ■ Componentes / Parts / Accessoires / Accessori

| 269



APINP



APSP



AVTEP



AMPP C



AMS



APAP



APVTA

## Accesorios abrazaderas TrΔle

*Accessories for clamps - TrΔle*

*Accessoires colliers TrΔle*

*Accessori per collari TrΔle*

- Accesorios carril / Accessories for lane / Accessoires pour lane / Accessori per binario

| 271



TC/T5

TrΔle Pipe

Pipe Fittings DIN 2353  
/ Flare fittings JIC 37°

SAE Flanges

TrΔle Clamps

Machines for  
processing rigid pipes

# Abrazaderas Serie ligera TrΔle

Clamps for pipe - TrΔle  
Colliers de fixation TrΔle  
Collari Serie leggera TrΔle

## Abrazadera simple completa, serie ligera

Light series simple clamp

Collier de fixation complet simple, série légère

Collari fissatubo serie leggera singoli



DN	GROUP GRUPO	UNITS PER BAG CANTIDAD / BOLSA	Part nº Referencia	€
6	1	10	A40AZ06	1,50
8	1	10	A40AZ08	1,50
10	1	10	A40AZ10	1,50
12	1	10	A40AZ12	1,50
1/4"	2	10	A40AZ13.2	1,60
14	2	10	A40AZ14	1,60
15	2	10	A40AZ15	1,60
16	2	10	A40AZ16	1,60
3/8"	2	10	A40AZ16.7	1,60
18	2	10	A40AZ18	1,60
19	3	10	A40AZ19	1,90
20	3	10	A40AZ20	1,90
1/2"	3	10	A40AZ21.3	1,90
22	3	10	A40AZ22	1,90
25	3	10	A40AZ25	1,90
3/4"	4	10	A40AZ26.7	2,19
28	4	10	A40AZ28	2,19
30	4	10	A40AZ30	2,19
32	5	10	A40AZ32	2,83
1"	5	10	A40AZ33.3	2,83
35	5	10	A40AZ35	2,83
38	5	10	A40AZ38	2,83
40	5	10	A40AZ40	2,83
42	5	10	A40AZ42	2,83
1"1/2	6	10	A40AZ48.3	3,86
50.8	6	10	A40AZ50.8	3,86

Consultar plásticos en poliamida / Polyamide plastics on request / Plastique polyamide sur demande / Plastica polyamide su richiesta

## Abrazadera completa, serie ligera reforzada

Light series reinforced clamp

Colliers de fixation simple série légère renforcés

Collare fissatubo rin forzato completo



DN	GROUP GRUPO	UNITS PER BAG CANTIDAD / BOLSA	Part nº Referencia	€
6	1	10	A41AZ06	1,81
8	1	10	A41AZ08	1,81
10	1	10	A41AZ10	1,81
12	1	10	A41AZ12	1,81
1/4"	2	10	A41AZ13.2	2,02
14	2	10	A41AZ14	2,02
15	2	10	A41AZ15	2,02
16	2	10	A41AZ16	2,02
3/8"	2	10	A41AZ16.7	2,02
18	2	10	A41AZ18	2,02
20	3	10	A41AZ20	2,36
1/2"	3	10	A41AZ21.3	2,36
22	3	10	A41AZ22	2,36
25	3	10	A41AZ25	2,36
3/4"	4	10	A41AZ26.7	2,72
28	4	10	A41AZ28	2,72
30	4	10	A41AZ30	2,72
1"	5	10	A41AZ33.7	3,46
35	5	10	A41AZ35	3,46
38	5	10	A41AZ38	3,46
40	5	10	A41AZ40	3,46
42	5	10	A41AZ42	3,46
44.5	6	10	A41AZ44.5	4,62
1"1/2	6	10	A41AZ48.3	4,62
50.8	6	10	A41AZ50.8	4,62

Consultar plásticos en poliamida / Polyamide plastics on request / Plastique polyamide sur demande / Plastica polyamide su richiesta

## Abrazadera simple completa, serie ligera, plásticos perfil liso

Light series simple clamp, plastic smooth profile

Collier de fixation complet simple, série légère, plastique profil lisse

Collari fissatubo serie leggera singoli, plastica profil liso



DN	GROUP GRUPO	UNITS PER BAG CANTIDAD / BOLSA	Part nº Referencia	€
8	1	10	A40AZ08PL	1,50
10	1	10	A40AZ10PL	1,50
12	1	10	A40AZ12PL	1,50
1/4"	2	10	A40AZ13.2PL	1,60
15	2	10	A40AZ15PL	1,60
3/8"	2	10	A40AZ16.7PL	1,60
18	2	10	A40AZ18PL	1,60
20	3	10	A40AZ20PL	1,90
1/2"	3	10	A40AZ21.3PL	1,90
22	3	10	A40AZ22PL	1,90
25	3	10	A40AZ25PL	1,90
3/4"	4	10	A40AZ26.7PL	2,19
28	4	10	A40AZ28PL	2,19
30	4	10	A40AZ30PL	2,19
1"	5	10	A40AZ33.3PL	2,83
35	5	10	A40AZ35PL	2,83
38	5	10	A40AZ38PL	2,83
42	5	10	A40AZ42PL	2,83

## Abrazadera completa, serie ligera reforzada, plásticos perfil liso

Light series reinforced clamp, plastic smooth profile

Colliers de fixation simple série légère renforcés, plastique profil lisse

Collare fissatubo rin forzato completo, plastica profil liso



DN	GROUP GRUPO	UNITS PER BAG CANTIDAD / BOLSA	Part nº Referencia	€
8	1	10	A41AZ08PL	1,81
10	1	10	A41AZ10PL	1,81
12	1	10	A41AZ12PL	1,81
1/4"	2	10	A41AZ13.2PL	2,02
15	2	10	A41AZ15PL	2,02
3/8"	2	10	A41AZ16.7PL	2,02
18	2	10	A41AZ18PL	2,02
20	3	10	A41AZ20PL	2,36
1/2"	3	10	A41AZ21.3PL	2,36
22	3	10	A41AZ22PL	2,36
25	3	10	A41AZ25PL	2,36
3/4"	4	10	A41AZ26.7PL	2,72
28	4	10	A41AZ28PL	2,72
30	4	10	A41AZ30PL	2,72
1"	5	10	A41AZ33.3PL	3,46
35	5	10	A41AZ35PL	3,46
38	5	10	A41AZ38PL	3,46
42	5	10	A41AZ42PL	3,46

# Abrazaderas Serie ligera TrΔle

Clamps for pipe - TrΔle  
Colliers de fixation TrΔle  
Collari Serie leggera TrΔle

TrΔle pipe

Pipe Fittings, DIN 2353  
/ Flare fittings, JIC 37°

SAE Flanges

TrΔle Clamps

Machines for  
processing rigid pipes

## Abrazadera simple completa, serie ligera, Aluminio

Complete simple clamp, light series, aluminium

Collier simple complet, série légère, aluminium

Collare fissatubo completo singolo, serie leggera, in Alluminio



GROUP GRUPO	UNITS PER BAG CANTIDAD / BOLSA	Part n° Referencia	€
1	10	A40AL06	*
1	10	A40AL08	*
1	10	A40AL10	*
1	10	A40AL12	*
2	10	A40AL13.5	*
2	10	A40AL14	*
2	10	A40AL15	*
2	10	A40AL16	*
2	10	A40AL17.2	*
2	10	A40AL18	*
3	10	A40AL19	*
3	10	A40AL20	*
3	10	A40AL21.3	*
3	10	A40AL22	*
3	10	A40AL25	*
4	10	A40AL26.9	*
4	10	A40AL28	*
4	10	A40AL30	*
5	10	A40AL32	*
5	10	A40AL33.7	*
5	10	A40AL35	*
5	10	A40AL38	*
5	10	A40AL40	*
5	10	A40AL42	*
6	10	A40AL48.3	*
6	10	A40AL50.8	*

## Abrazadera completa, serie ligera reforzada, Aluminio

Complete simple clamp, light series reinforced, aluminium

Collier complet, série légère renforcée, aluminium

Collare fissatubo completo, serie leggera rinforzata, in Alluminio



GROUP GRUPO	UNITS PER BAG CANTIDAD / BOLSA	Part n° Referencia	€
1	10	A41AL06	*
1	10	A41AL08	*
1	10	A41AL10	*
1	10	A41AL12	*
2	10	A41AL13.5	*
2	10	A41AL14	*
2	10	A41AL15	*
2	10	A41AL16	*
2	10	A41AL17.2	*
2	10	A41AL18	*
3	10	A41AL19	*
3	10	A41AL20	*
3	10	A41AL21.3	*
3	10	A41AL22	*
3	10	A41AL25	*
4	10	A41AL26.9	*
4	10	A41AL28	*
4	10	A41AL30	*
5	10	A41AL32	*
5	10	A41AL33.7	*
5	10	A41AL35	*
5	10	A41AL38	*
5	10	A41AL40	*
5	10	A41AL42	*
6	10	A41AL48.3	*
6	10	A41AL50.8	*

## PROPIEDADES DE MATERIALES | MATERIAL PROPERTIES

	POLIPROPILENO Polypropilene (PP)	POLIAMIDA Polyamide (PA)	ALUMINIO Aluminium (AL)	ELASTOMEROS TERMOPLASTICOS Thermoplastic elastomer (TPE)
<b>PROPIEDADES MECÁNICAS   Mechanical properties</b>				
ENSAYO IZOD (Mellado, 23°C) Izod Impact Strength (Notched, 23°C)	>40 KJ/m2 ISO 180	>5 KJ/m2 ISO 180		
ENSAYO IZOD (Mellado, -30°C) Izod Impact Strength (Notched, -30°C)	>6 KJ/m2 ISO 180	>2 KJ/m2 ISO 180		
MÓDULO DE ELASTICIDAD Modulus of elasticity	1200-1250 N/mm2 ISO 527-2	>2000 N/mm2 ISO 527-2	70.000 N/mm2	3,6 N/mm2 (MODULUS@100) ASTM D 412
RESISTENCIA A LA TRACCIÓN Tensile strength	>23 N/mm2 ISO 527-2	>60 N/mm2 ISO 527-2	>160 N/mm2 DIN EN 10002	>3,95 N/mm2 ASTM D 412
DUREZA HARDNESS	>80 ISO 2039-2 (Rockwell-R)	>70 ISO 868 (Shore D)	>80 Brinell hardness	>85 ASTM D 2240 (Shore A)
<b>RANGO DE TEMPERATURAS temperature range</b>	<b>-30°C/90°C</b>	<b>-40°C/120°C</b>	<b>Max. 300°C</b>	<b>-40°C/120°C</b>
<b>PROPIEDADES QUÍMICAS   Chemical properties</b>				
ÁCIDOS, DISOLVENTES Acids, Solvents	RESISTENTE (según concentración) Conditionally Consistent	RESISTENTE (según concentración) Conditionally Consistent	RESISTENTE (según concentración) Conditionally Consistent	RESISTENTE (según concentración) Conditionally Consistent
HIDROCARBUROS, ACEITES MINERALES Hydrocarbons, Mineral oils	RESISTENTE (según concentración) Conditionally Consistent	RESISTENTE Consistent	RESISTENTE Consistent	RESISTENTE Consistent
ALCOHOL, AGUA DE MAR, OTROS ACEITES Alcohol, Seawater, Other oils	RESISTENTE Consistent	RESISTENTE Consistent	RESISTENTE Consistent	RESISTENTE Consistent

# Abrazaderas Serie ligera TrΔle

Clamps for pipe - TrΔle  
Colliers de fixation TrΔle  
Collari Serie leggera TrΔle

## Plásticos polipropileno, serie ligera

Plastics polypropylene simple, light series

Plastique polypropylene, série légère

Plastica polipropilene serie leggera



DN	GROUP GRUPO	Part n° Referencia	€
6	1	A106C	0,61
8	1	A108C	0,61
10	1	A110C	0,61
12	1	A112C	0,61
1/4"	2	A213.2C	0,63
14	2	A214C	0,63
15	2	A215C	0,63
3/8"	2	A216.7C	0,63
16	2	A216C	0,63
18	2	A218C	0,63
19	3	A319C	0,82
20	3	A320C	0,82
1/2"	3	A321.3C	0,82
22	3	A322C	0,82
23	3	A323C	0,82
25	3	A325C	0,82
3/4"	4	A426.7C	0,99
28	4	A428C	0,99
30	4	A430C	0,99
32	5	A532C	1,50
1"	5	A533.7C	1,50
35	5	A535C	1,50
38	5	A538C	1,50
40	5	A540C	1,50
42	5	A542C	1,50
44.5	6	A644.5C	2,30
1 1/2"	6	A648.3C	2,30
50.8	6	A650.8C	2,30

Precio por pareja / Price per couple / Prix par paire / Prezzo per coppia

## Plásticos perfil liso, serie ligera

Plastics smooth profile, light series

Plastique profil lisse, série légère

Plastica profil liscio, serie leggera



GROUP GRUPO	Part n° Referencia	€
1	AL108C	0,61
1	AL110C	0,61
1	AL112C	0,61
2	AL213.2C	0,63
2	AL215C	0,63
2	AL216.7C	0,63
2	AL218C	0,63
3	AL320C	0,82
3	AL321.3C	0,82
3	AL322C	0,82
3	AL325C	0,82
4	AL426.7C	0,99
4	AL428C	0,99
4	AL430C	0,99
5	AL533.3C	1,50
5	AL535C	1,50
5	AL538C	1,50
5	AL542C	1,50

Precio por pareja / Price per couple / Prix par paire / Prezzo per coppia

## Cuerpo abrazadera Aluminio, serie ligera

Aluminium clamp body, light series

Corps collier aluminium, série légère

Corpo collare in Alluminio, serie leggera



GROUP GRUPO	Part n° Referencia	€
1	A106AL	*
1	A108AL	*
1	A110AL	*
1	A112AL	*
2	A213.5AL	*
2	A214AL	*
2	A215AL	*
2	A216AL	*
2	A217.2AL	*
2	A218AL	*
3	A319AL	*
3	A320AL	*
3	A321.3AL	*
3	A322AL	*
3	A325AL	*
4	A426.9AL	*
4	A428AL	*
4	A430AL	*
5	A532AL	*
5	A533.7AL	*
5	A535AL	*
5	A538AL	*
5	A540AL	*
5	A542AL	*
6	A648.3AL	*
6	A650.8AL	*

## Plásticos para abrazaderas anti-vibración

Plastic for anti-vibration clamps

Plastiques pour colliers de fixation anti-vibratoire

Plastici per collari fissatubo anti-vibrazioni



DN	SERIE	GROUP GRUPO	Part n° Referencia	€
12.7	L	4	AML401270	6,69
14	L	4	AML401400	6,69
19	L	4	AML401900	6,69
22	L	6	AML602200	9,73
28	L	6	AML602800	9,73
30	L	6	AML603000	9,73

Precio por pareja / Price per couple / Prix par paire / Prezzo per coppia

# Abrazaderas Serie ligera TrΔle

Clamps for pipe - TrΔle  
Colliers de fixation TrΔle  
Collari Serie leggera TrΔle

TrΔle Pipe

Pipe Fittings, DIN 2353  
/ Flare fittings, JIC 37°

SAE Flanges

TrΔle Clamps

Machines for  
processing rigid pipes

## Chapas inferiores, serie ligera

Lower plate simple, light series

Plaques inférieures à souder série légère

Piastre inferiori, serie leggera



GROUP GRUPO	Part n° Referencia	€
1	<b>APIN1</b>	<b>0,71</b>
2	<b>APIN2</b>	<b>0,73</b>
3	<b>APIN3</b>	<b>0,82</b>
4	<b>APIN4</b>	<b>0,91</b>
5	<b>APIN5</b>	<b>0,97</b>
6	<b>APIN6</b>	<b>1,15</b>

## Tornillos cabeza hexagonal, serie ligera reforzada

Hexagonal bolt, light series reinforced

Vis hexagonale, série légère renforcée

Vite esagonale, serie leggera rinforzata



THREAD ROSCA	GROUP GRUPO	Part n° Referencia	€
M6	1	<b>AVTE1</b>	<b>0,11</b>
M6	2	<b>AVTE2</b>	<b>0,12</b>
M6	3	<b>AVTE3</b>	<b>0,14</b>
M6	4	<b>AVTE4</b>	<b>0,16</b>
M6	5	<b>AVTE5</b>	<b>0,22</b>
M6	6	<b>AVTE6</b>	<b>0,25</b>

## Chapa agrupar abrazaderas simples

Jointed plate for simple clamp

Plaque à joindre pour collier simple

Piastre per collare fissatubo singolo



GROUP GRUPO	CLAMP QTY. N° ABRAZADERAS	Part n° Referencia	€
1	10	<b>APAG1</b>	<b>11,47</b>
2	10	<b>APAG2</b>	<b>12,23</b>
3	10	<b>APAG3</b>	<b>12,65</b>

## Tornillo apilar ligera

Light serie screw to pile up

Vis pour empiler série légère

Vite per piastra componibili. Serie leggera



THREAD ROSCA	GROUP GRUPO	Part n° Referencia	€
M6	1	<b>AVTA1</b>	<b>2,10</b>
M6	2	<b>AVTA2</b>	<b>2,16</b>
M6	3	<b>AVTA3</b>	<b>2,46</b>
M6	4	<b>AVTA4</b>	<b>2,67</b>
M6	5	<b>AVTA5</b>	<b>3,14</b>

## Chapas superiores, serie ligera reforzada

Upper plate, light series reinforced

Plaques supérieures de protection, série légère renforcée

Piastre superiori, serie leggera rinforzata



GROUP GRUPO	Part n° Referencia	€
1	<b>APS1</b>	<b>0,33</b>
2	<b>APS2</b>	<b>0,42</b>
3	<b>APS3</b>	<b>0,46</b>
4	<b>APS4</b>	<b>0,53</b>
5	<b>APS5</b>	<b>0,62</b>
6	<b>APS6</b>	<b>0,75</b>

## Tornillos cabeza Allen, serie ligera

Simple Allen bolt, light series

Vis tête six pans creux Allen série légère

Vite Allen, serie leggera



THREAD ROSCA	GROUP GRUPO	Part n° Referencia	€
M6	1	<b>AVTC1</b>	<b>0,11</b>
M6	2	<b>AVTC2</b>	<b>0,13</b>
M6	3	<b>AVTC3</b>	<b>0,14</b>
M6	4	<b>AVTC4</b>	<b>0,17</b>
M6	5	<b>AVTC5</b>	<b>0,23</b>
M6	6	<b>AVTC6</b>	<b>0,23</b>

## Chapa atornillar Abr. Simples

Elongated weld plate

Plaque à visser

Piastre per fissaggio



GROUP GRUPO	Part n° Referencia	€
1	<b>APT1</b>	<b>0,91</b>
2	<b>APT2</b>	<b>0,93</b>
3	<b>APT3</b>	<b>0,99</b>
4	<b>APT4</b>	<b>1,06</b>
5	<b>APT5</b>	<b>1,15</b>

## Chapa apilar ligera

Light serie plate to pile up

Plaque pour empiler série légère

Piastre componibili. Serie leggera



GROUP GRUPO	Part n° Referencia	€
1	<b>APA1</b>	<b>0,27</b>
2	<b>APA2</b>	<b>0,34</b>
3	<b>APA3</b>	<b>0,42</b>
4	<b>APA4</b>	<b>0,49</b>
5	<b>APA5</b>	<b>0,51</b>
6	<b>APA6</b>	<b>0,63</b>

# Abrazaderas Serie doble TrΔle

Clamps double Series - TrΔle  
Colliers Serie double TrΔle  
Collari Serie doppi TrΔle

## Abrazaderas dobles completas

Double clamp - parallel

Colliers de fixation doubles complets

Collare fissatubo doppio completo



DN	GROUP GRUPO	UNITS PER BAG CANTIDAD / BOLSA	Part nº Referencia	€
6	1	10	AZCFS06	1,79
8	1	10	AZCFS08	1,79
10	1	10	AZCFS10	1,79
12	1	10	AZCFS12	1,79
1/4"	2	10	AZCFS13.2	2,47
14	2	10	AZCFS14	2,47
15	2	10	AZCFS15	2,47
16	2	10	AZCFS16	2,47
3/8"	2	10	AZCFS16.7	2,47
18	2	10	AZCFS18	2,47
19	3	10	AZCFS19	2,95
20	3	10	AZCFS20	2,95
1/2"	3	10	AZCFS21.3	2,95
22	3	10	AZCFS22	2,95
25	3	10	AZCFS25	2,95
3/4"	4	10	AZCFS26.7	3,54
28	4	10	AZCFS28	3,54
30	4	10	AZCFS30	3,54
32	5	10	AZCFS32	4,68
1"	5	10	AZCFS33.3	4,68
35	5	10	AZCFS35	4,68
38	5	10	AZCFS38	4,68
40	5	10	AZCFS40	4,68
42	5	10	AZCFS42	4,68

Consultar plásticos en poliamida y aluminio / Polyamide and aluminium plastics, on request /  
Plastique polyamide et aluminium, sur demande / Plastica polyamide e alluminio, su richiesta

## Chapas inferiores

Double lower plate

Plaques inférieures à souder doubles

Piastre inferiori



THREAD ROSCA	GROUP GRUPO	Part nº Referencia	€
M6	1	ADPIN1	0,84
M8	2	ADPIN2	1,08
M8	3	ADPIN3	1,26
M8	4	ADPIN4	1,44
M8	5	ADPIN5	1,72

## Chapas superiores

Double upper plate

Plaques supérieures de protection doubles

Piastre superiori



GROUP GRUPO	Part nº Referencia	€
1	ADPS1	0,33
2	ADPS2	0,42
3	ADPS3	0,51
4	ADPS4	0,64
5	ADPS5	0,82

## Tornillos cabeza hexagonal

Double hexagonal bolt

Vis hexagonale

Vite esagonale



THREAD ROSCA	GROUP GRUPO	Part nº Referencia	€
M6	1	ADVTE1	0,13
M8	2	ADVTE2	0,24
M8	3	ADVTE3	0,28
M8	4	ADVTE4	0,33
M8	5	ADVTE5	0,36

# Abrazaderas Serie doble TrΔle

Clamps double Series - TrΔle

Colliers Serie double TrΔle

Collari Serie doppi TrΔle

TrΔle Pipe

Pipe Fittings DIN 2353  
/ Flare fittings JIC 37°

SAE Flanges

TrΔle Clamps

Machines for  
processing rigid pipes

## Plásticos polipropileno dobles

Double plastics polypropylene

Double plastiques polypropylene

Plastica polipropilene



DN	GROUP GRUPO	Part n° Referencia	€
6	1	AD106C	0,68
8	1	AD108C	0,68
10	1	AD110C	0,68
12	1	AD112C	0,68
1/4"	2	AD213.2C	0,78
14	2	AD214C	0,78
15	2	AD215C	0,78
3/8"	2	AD216.7C	0,78
16	2	AD216C	0,78
18	2	AD218C	0,78
19	3	AD319C	0,95
20	3	AD320C	0,95
1/2"	3	AD321.3C	0,95
22	3	AD322C	0,95
25	3	AD325C	0,95
3/4"	4	AD426.7C	1,20
28	4	AD428C	1,20
30	4	AD430C	1,20
32	5	AD532C	1,86
1"	5	AD533.3C	1,86
35	5	AD535C	1,86
38	5	AD538C	1,86
40	5	AD540C	1,86
42	5	AD542C	1,86

Precio por pareja / Price per couple / Prix par paire / Prezzo per coppia

## Chapa apilar doble

Double series plate to pile up

Plaque pour empiler série double

Piastra componibili. Serie doppia



GROUP GRUPO	Part n° Referencia	€
1	ADPA1	0,44
2/3/4/5	ADPA2	0,44

## Chapa agrupar abrazaderas dobles

Jointed plate for double clamp

Plaque à joindre pour collier double

Piastra gruppo per collare fissatubo doppio



THREAD ROSCA	GROUP GRUPO	CLAMP QTY. N° ABRAZADERAS	Part n° Referencia	€
M6	1	5	ADPAG1	4,81
M8	2	2	A2DPIN2	2,64
M8	2	3	A3DPIN2	3,96
M8	2	5	ADPAG2	6,58
M8	3	3	A3DPIN3	5,36
M8	3	5	ADPAG3	7,34

## Tornillo apilar doble

Double series screw to pile up

Vis pour empiler série double

Vite per piastra componibili. Serie doppia



THREAD ROSCA	GROUP GRUPO	Part n° Referencia	€
M8	2	ADVTA2	2,61
M8	3	ADVTA3	2,95
M8	4	ADVTA4	3,20

Para Grupo 1: AVTA1 (ligera) / For Group 1: AVTA1 (Light) / Pour le Groupe 1: AVTA1 (légère) / Per il Gruppo 1: AVTA1 (leggera)

# Abrazaderas Serie pesada TrΔle

Clamps heavy Series - TrΔle

Colliers Série lourde TrΔle

Collari Serie pesante TrΔle

## Abrazadera completa, serie pesada

Heavy clamp, heavy series

Collier de fixation simple complet, série lourde

Collare fissatubo serie pesante completo



DN	GROUP GRUPO	Part nº Referencia	€
6	1	AZCPS06	6,97
8	1	AZCPS08	6,97
10	1	AZCPS10	6,97
12	1	AZCPS12	6,97
1/4"	1	AZCPS13.2	6,97
14	1	AZCPS14	6,97
15	1	AZCPS15	6,97
16	1	AZCPS16	6,97
3/8"	1	AZCPS17.2	6,97
18	1	AZCPS18	6,97
20	2	AZCPS20	7,88
1/2"	2	AZCPS21.3	7,88
22	2	AZCPS22	7,88
25	2	AZCPS25	7,88
3/4"	2	AZCPS26.7	7,88
28	2	AZCPS28	7,88
30	2	AZCPS30	7,88
32	3	AZCPS32	9,25
1"	3	AZCPS33.3	9,25
35	3	AZCPS35	9,25
38	3	AZCPS38	9,25
40	3	AZCPS40	9,25
42	3	AZCPS42	9,25
1"1/4	4	AZCPS42.4	21,33
45	4	AZCPS45	21,33
48-1" 1/2	4	AZCPS48	21,33
1"1/2	4	AZCPS48.4	21,33
50	4	AZCPS50	21,33
55	4	AZCPS55	21,33
60	4	AZCPS60	21,33
2"	4	AZCPS60.3	21,33
65	4	AZCPS65	21,33
70	4	AZCPS70	21,33

Consultar plásticos en poliamida y aluminio / Polyamide and aluminium plastics, on request /  
Plastique polyamide et aluminium, sur demande / Plastica polyamide e alluminio, su richiesta

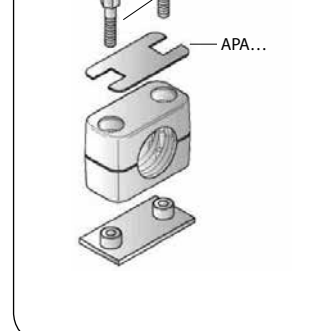
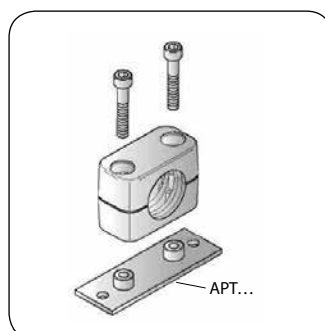
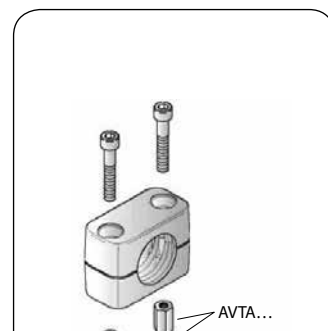
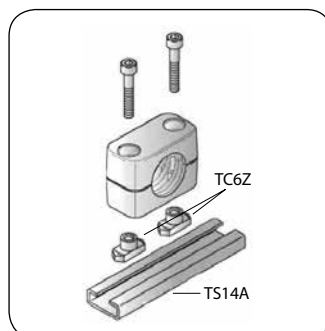
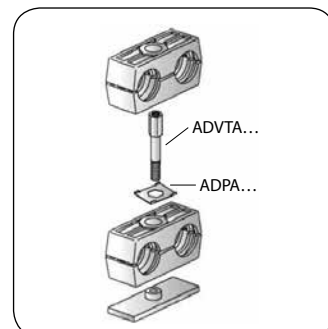
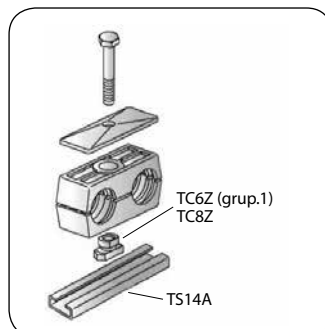
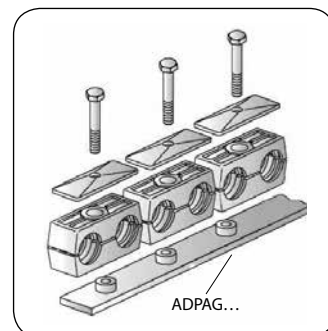
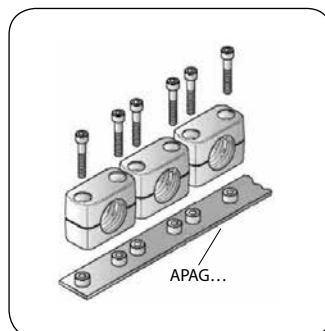

# Abrazaderas Serie pesada TrΔle

Clamps heavy Series - TrΔle  
Colliers Série lourde TrΔle  
Collari Serie pesante TrΔle

## Chapas inferiores, serie pesada

Lower plate, heavy series

Plaques inférieures à souder, série lourde

Piastre inferiori, serie pesante



THREAD ROSCA	GROUP GRUPO	Part n° Referencia	€
M10	1	APINP1	2,66
M10	2	APINP2	2,87
M10	3	APINP3	3,12
M12	4	APINP4	6,24

## Chapas superiores, serie pesada

Upper plate, heavy series

Plaques supérieures de protection, série lourde

Piastre superiori, serie pesante



GROUP GRUPO	Part n° Referencia	€
1	APSP1	1,14
2	APSP2	1,29
3	APSP3	1,48
4	APSP4	3,63

## Tornillos cabeza hexagonal, serie pesada

Hexagonal bolt, heavy series

Vis hexagonale, série lourde

Vite esagonale, serie pesante



THREAD ROSCA	GROUP GRUPO	Part n° Referencia	€
M10	1	AVTEP1	0,53
M10	2	AVTEP2	0,65
M10	3	AVTEP3	0,72
M12	4	AVTEP4	1,37

## Plásticos polipropileno, serie pesada

Plastics polypropylene, heavy series

Plastique polypropylene, série lourde

Plastica polipropilene, serie pesante



DN	GROUP GRUPO	Part n° Referencia	€
6	1	AMPP106C	1,62
8	1	AMPP108C	1,62
10	1	AMPP110C	1,62
12	1	AMPP112C	1,62
1/4"	1	AMPP113.2C	1,62
14	1	AMPP114C	1,62
15	1	AMPP115C	1,62
16	1	AMPP116C	1,62
3/8"	1	AMPP117.2C	1,62
18	1	AMPP118C	1,62
20	2	AMPP220C	1,77
1/2"	2	AMPP221.3C	1,77
22	2	AMPP222C	1,77
25	2	AMPP225C	1,77
3/4"	2	AMPP226.7C	1,77
28	2	AMPP228C	1,77
30	2	AMPP230C	1,77
30	3	AMPP330C	2,51
32	3	AMPP332C	2,51
1"	3	AMPP333.3C	2,51
35	3	AMPP335C	2,51
38	3	AMPP338C	2,51
40	3	AMPP340C	2,51
42	3	AMPP342C	2,51
38	4	AMPP438C	7,13
42-1" 1/4	4	AMPP442C	7,13
45	4	AMPP445C	7,13
48-1" 1/2	4	AMPP448C	7,13
50	4	AMPP450C	7,13
55	4	AMPP455C	7,13
2"	4	AMPP460.3C	7,13
65	4	AMPP465C	7,13
70	4	AMPP470C	7,13

Precio por pareja / Price per couple / Prix par paire / Prezzo per coppia

## Plásticos para abrazaderas anti-vibración

Plastic for anti-vibration clamps

Plastiques pour colliers de fixation  
antivibratoire

Plastici per collari fissatubo anti-vibrazioni, serie  
pesante



DN	SERIE	GROUP GRUPO	Part n° Referencia	€
35	S	4	AMS403500	22,71
38	S	4	AMS403800	22,71

Precio por pareja / Price per couple / Prix par paire / Prezzo per coppia

# Abrazaderas Serie pesada TrΔle

Clamps heavy Series - TrΔle  
 Colliers Série lourde TrΔle  
 Collari Serie pesante TrΔle

## Chapa apilar Pesada

Heavy series plate to pile up

Plaque pour empiler série lourde

Piastra componibili, serie pesante



GROUP GRUPO	Part n° Referencia	€
1	<b>APAP1</b>	<b>2,34</b>
2	<b>APAP2</b>	<b>2,81</b>
3	<b>APAP3</b>	<b>3,75</b>
4	<b>APAP4</b>	<b>6,09</b>

## Tornillo para serie pesada apilable

Screw to pile up heavy series

Vis à empiler série lourde

Vite per serie pesante impilabile



THREAD ROSCA	GROUP GRUPO	Part n° Referencia	€
M10	1	<b>APVTA1</b>	<b>2,61</b>
M10	2	<b>APVTA2</b>	<b>3,10</b>
M10	3	<b>APVTA3</b>	<b>3,71</b>
M12	4	<b>APVTA4</b>	<b>7,25</b>

# Accesorios abrazaderas TrΔle

Accessories for clamps - TrΔle

Accessoires colliers TrΔle

Accessori per collari TrΔle

## Accesorios carril

Accessories for lane

Accessories pour lane

Accessori per binario



THREAD ROSCA	SIZE TAMAÑO	DESCRIPTION DESCRIPCIÓN	Part nº Referencia	€
M6	--	Rail nut	<b>TC6A</b>	<b>1,69</b>
M8	--	Rail nut	<b>TC8A</b>	<b>5,27</b>
M10	--	Rail nut	<b>TC10A</b>	<b>5,69</b>
M12	--	Rail nut	<b>TC12A</b>	<b>7,17</b>
--	11x28	Mounting rail - 1m	<b>TS11A</b>	<b>9,59</b>
--	14x28	Mounting rail - 1m	<b>TS14A</b>	<b>10,65</b>
--	22x40	Mounting rail - 1m	<b>TSP22</b>	<b>82,61</b>

SERIE LIGERA  
LIGHT SERIES



11x28



14x28



SERIE DOBLE  
DOUBLE SERIES



GR 2-3-4-5



11x28



14x28



SERIE PESADA  
HEAVY SERIES



GR 4



22x40



## Máquinas para procesar el tubo rígido

*Machines for processing rigid pipes*

Machines pour travailler le tube rigide

*Macchine per il trattamento del tubo rigido*

## Máquinas para procesar el tubo rígido

*Machines for processing rigid pipes*

Machines pour travailler le tube rigide

*Macchine per il trattamento del tubo rigido*

0

5

# Accesorios

*Accessories*  
*Accessoires*  
*Accessori*

# TrAle®



**Adaptadores**

*Adaptors*  
*Adapteurs*  
*Adattatori*

1

**Enchufes rápidos**

*Quick-release couplings*  
*Coupleurs rapides*  
*Innesti rapidi*

2

**Llaves de paso**

*Ball valves*  
*Robinets*  
*Rubinetti*

3

**Desviadores**

*Diverter*  
*Déviateurs*  
*Deviatori di flusso*

4

**Racores giratorios**

*Swivel fittings*  
*Raccords tournants*  
*Raccordi girevoli*

5

**Multienchufes**

*Multi-way couplings*  
*Multi-coupleur*  
*Multinnesti rapidi*

6

**Protecciones**

*Protections*  
*Protections*  
*Protezioni*

7

# Adaptadores

*Adaptors*

*Adapteurs*

*Adattatori*

## **Adaptadores BSP , BSPT y Métricos**

286

*Metric, BSP and BSPT Adaptors*

*Adapteurs BSP, BSPT et Métrique*

*Adattatori BSP , BSPT e Metrico*

## **Adaptadores NPT**

302

*NPT Adaptors*

*Adapteurs NPT*

*Adattatori NPT*

## **Adaptadores ORFS**

307

*ORFS Adaptors*

*Adapteurs ORFS*

*Adattatori ORFS*

1

# Adaptadores BSP , BSPT y Métricos

Metric, BSP and BSPT Adaptors  
Adaptateurs BSP, BSPT et Métrique  
Adattatori BSP, BSPT e Metrico

Quick-release couplings

## ■ Uniones rectas macho / Straight adaptors male / Adapteur droit mâle-mâle / Adattatori diritti maschio | 286

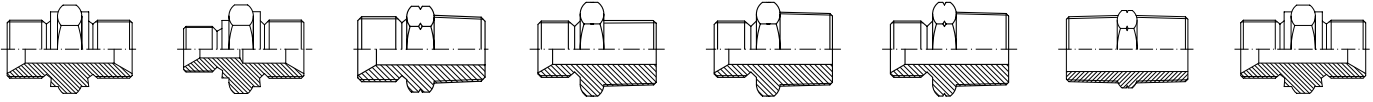

A1010

A1020

S1014

S1012

A1022

A1024

A1016

S1016

Ball valves

## ■ Uniones rectas macho-hembra / Adaptors male-female / Adapteur mâle-femelle / Adattatori diritti maschio-femmina | 288

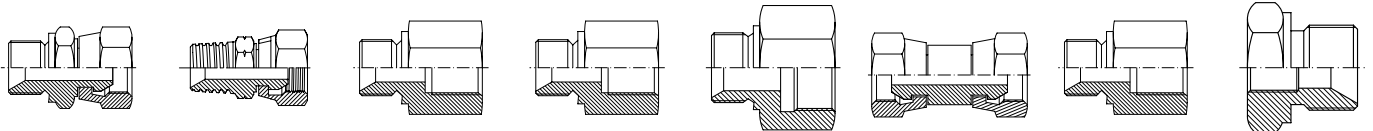

A1170

A1173

A1050

S10610

S106218

A1172 ●

A1060

A1150

Diversers

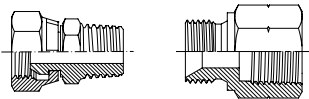

A1171

A1074

Swivel fittings

## ■ Tapones / Plugs & Caps / Bouchons adapteur / Tappi | 290

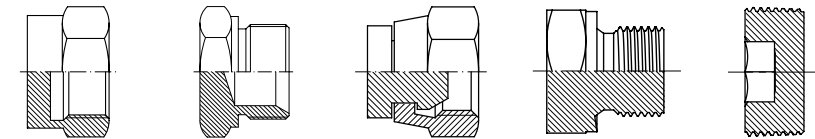

A1072

A1070

A1075

A1073 ●

A1071

Multi-way couplings

## ■ Uniones hembra y pasatabiques / Adaptors female and bulkheads / Unions femelle et passe cloison / Adattatori femmina e passaparete | 291

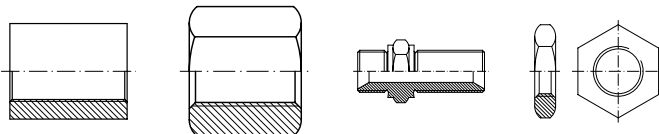

A1310

S10310

A1160

A1272

Protections

## ■ Orientables / Banjos / Adapteurs banjo / Adattatori a occhio | 292

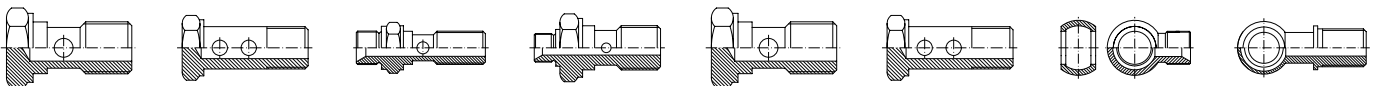

A1090

A1094

A1092

A1093

S1092

A1096

A1140

A1112

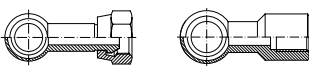

A1111

A1113

## ■ Soldables / Weldable adaptors / Adapteurs à souder / Adattatori a saldare | 293

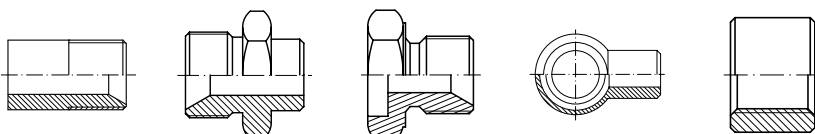

A1290

A1030

A1031

A1141

A1311

# Adaptadores BSP , BSPT y Métricos

Metric, BSP and BSPT Adaptors  
Adapteurs BSP, BSPT et Métrique  
Adattatori BSP, BSPT e Metrico

## Codos accesorios (tubo) / Accessorial elbows / Adapteurs coudes / Adattatori a 90° tubolari

294

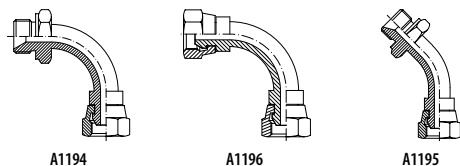

A1194

A1196

A1195

## Codos en forja / Forging elbows / Adapteurs coudes en forge / Adattatori a 90° forgiati

295

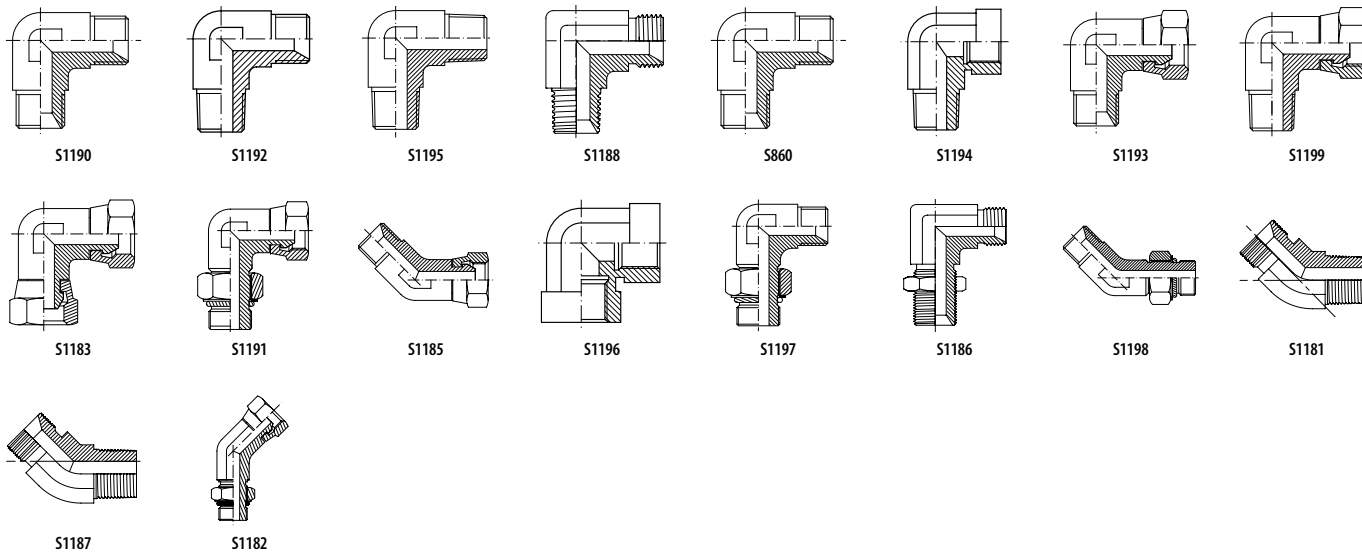

S1190

S1192

S1195

S1188

S860

S1194

S1193

S1199

S1183

S1191

S1185

S1196

S1197

S1186

S1198

S1181

S1187

S1182

## Te en forja y cruz / Forging Tees and croos / Adapteurs Tés en forge et des croix / Adattatori a T forgiati e croce

298

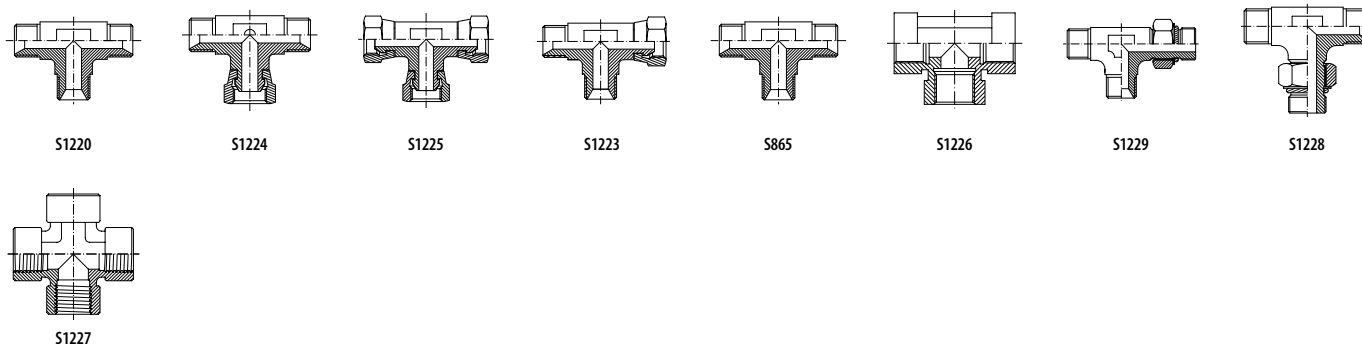

S1220

S1224

S1225

S1223

S865

S1226

S1229

S1228

S1227

## Codos, Te en bloque (cuadrado) y cruz / Square elbows, Tees and cross / Adapteurs coudes. Tés en bloque et des croix / Adattatori a 90°, T da quadro senza saldatura e croce

300

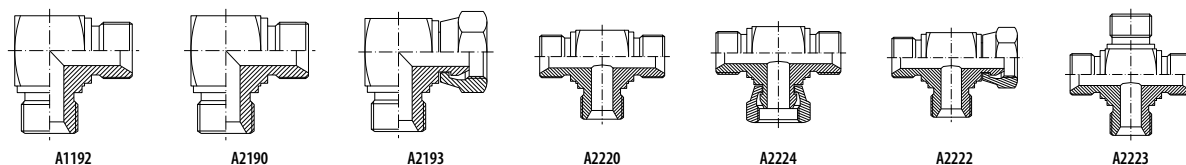

A1192

A2190

A2193

A2220

A2224

A2222

A2223

## Juntas metal Buna y arandelas / Bonded seals / Bague BS / Rondelle e rondelle Bonded

301

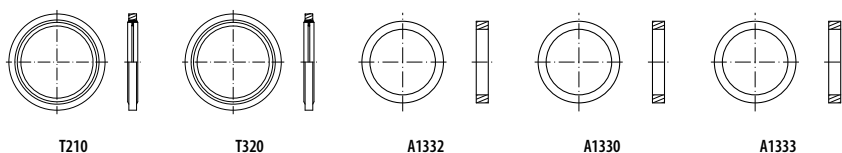

T210

T320

A1332

A1330

A1333

# Adaptadores NPT

NPT Adaptors  
Adaptateurs NPT  
Adattatori NPT

Quick-release couplings

- Uniones rectas macho-macho / Straight adaptors male / Unions mâle / Adattatori diritti maschio - maschio | 302

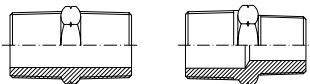

A1015

A1015

Ball valves

- Uniones rectas macho-hembra / Adaptors male-female / Unions mâle-femelle / Adattatori diritti maschio - femmina | 302

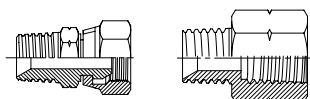

N1170

N1060

Diversers

- Uniones hembra / Adaptors female / Unions femelle / Adattatori femmina | 303

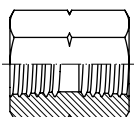

N10310

Swivel fittings

- Tapones / Plugs & Caps / Bouchons / Tappi | 303

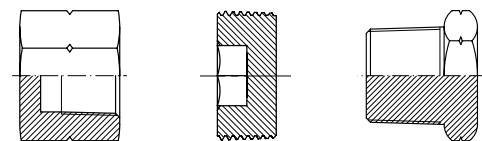

N1072

N1071

N1070

Multi-way couplings

- Codos en forja / Forging elbows / Adapteurs coude en forge / Adattatori a 90° e 45° forgiati | 304

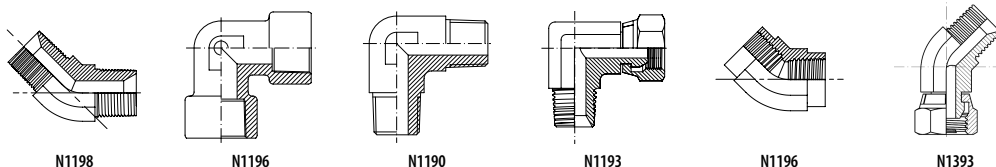

N1198

N1196

N1190

N1193

N1196

N1393

Protections

- Tes en forja / Forging tees / Adapteurs Té en forge / Adattatori a T forgiati | 305

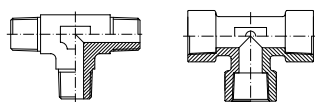

N1220

N1226

# Adaptadores ORFS

ORFS Adaptors  
Adapteurs ORFS  
Adattatori ORFS

## ORFS Rectos / Straight ORFS / ORFS Droits / Raccordi diritti ORFS

307

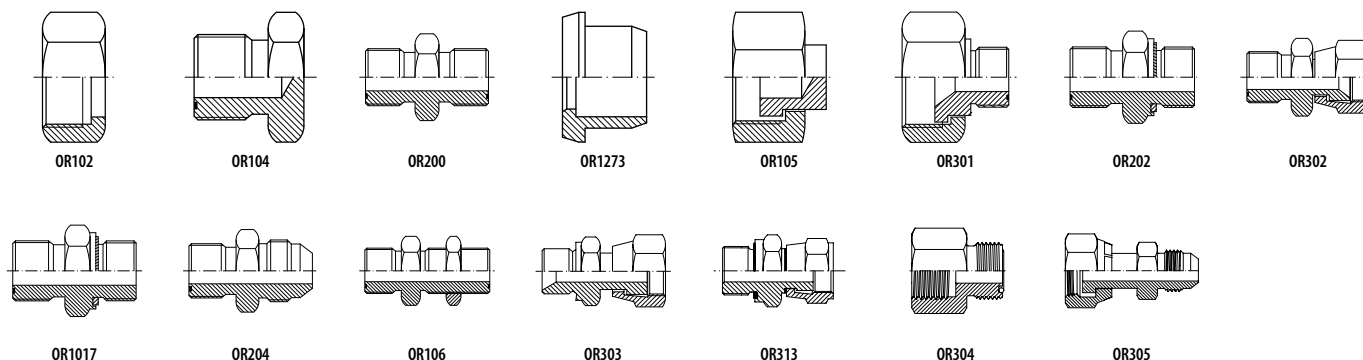

## Codos 45° ORFS / ORFS 45° Elbows / Coude 45° ORFS / Raccordi a 45° ORFS

309

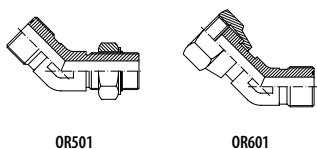

## Codos 90° ORFS / ORFS 90° Elbows / Coude 90° ORFS / Raccordi a 90° ORFS

310

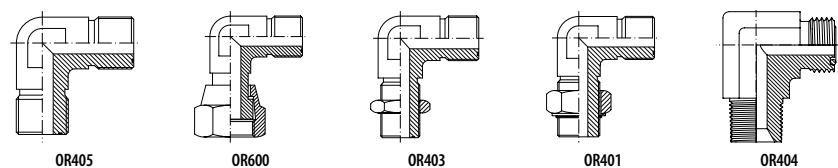

## Te ORFS / ORFS Tees / Tés ORFS / Raccordi a T ORFS

311

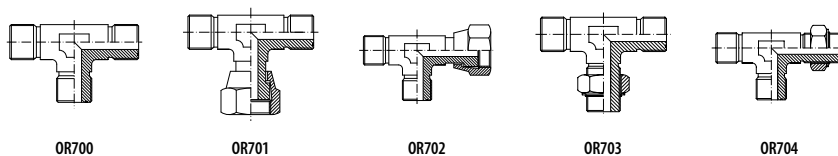

# Adaptadores BSP , BSPT y Métricos

Metric, BSP and BSPT Adaptors  
Adaptateurs BSP, BSPT et Métrique  
Adattatori BSP, BSPT e Metrico

## Adaptador macho-macho BSP (60°)

Adaptor BSP male-BSP male (60°)

Adaptateur mâle BSP x mâle BSP (60°)

Niples di giunzione BSP (60°)

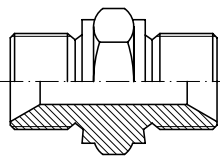

THREAD ROSCA		Part nº Referencia	€
1/8" BSP	1/8" BSP	<b>A101002</b>	<b>0,62</b>
1/4" BSP	1/4" BSP	<b>A101004</b>	<b>0,76</b>
1/4" BSP	1/4" BSP	<b>A101004H19</b>	<b>0,81</b>
3/8" BSP	3/8" BSP	<b>A101006</b>	<b>1,08</b>
1/2" BSP	1/2" BSP	<b>A101008</b>	<b>1,63</b>
5/8" BSP	5/8" BSP	<b>A101010</b>	<b>2,34</b>
3/4" BSP	3/4" BSP	<b>A101012</b>	<b>2,56</b>
1" BSP	1" BSP	<b>A101016</b>	<b>4,75</b>
1"1/4 BSP	1"1/4 BSP	<b>A101020</b>	<b>8,47</b>
1"1/2 BSP	1"1/2 BSP	<b>A101024</b>	<b>12,05</b>
2" BSP	2" BSP	<b>A101032</b>	<b>20,63</b>
2" 1/2 BSP	2" 1/2 BSP	<b>A101040</b>	<b>40,85</b>
3" BSP	3" BSP	<b>A101048</b>	<b>59,42</b>

## Reductor macho-macho BSP (60°)

Reducer adaptor BSP male-BSP male (60°)

Reducteur mâle BSP x mâle BSP (60°)

Niples di riduzione BSP (60°)

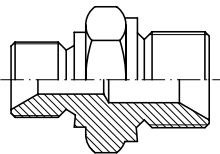

THREAD ROSCA		Part nº Referencia	€
1/8" BSP	1/4" BSP	<b>A10200204</b>	<b>0,94</b>
1/8" BSP	3/8" BSP	<b>A10200206</b>	<b>1,52</b>
1/4" BSP	3/8" BSP	<b>A10200406</b>	<b>1,25</b>
1/4" BSP	1/2" BSP	<b>A10200408</b>	<b>1,72</b>
3/8" BSP	1/2" BSP	<b>A10200608</b>	<b>1,56</b>
3/8" BSP	3/4" BSP	<b>A10200612</b>	<b>2,64</b>
1/2" BSP	3/4" BSP	<b>A10200812</b>	<b>2,62</b>
1/2" BSP	1" BSP	<b>A10200816</b>	<b>4,82</b>
5/8" BSP	1/2" BSP	<b>A10201008</b>	<b>2,94</b>
5/8" BSP	3/4" BSP	<b>A10201012</b>	<b>3,05</b>
3/4" BSP	1" BSP	<b>A10201216</b>	<b>4,83</b>
3/4" BSP	1"1/4 BSP	<b>A10201220</b>	<b>7,06</b>
1" BSP	1"1/4 BSP	<b>A10201620</b>	<b>8,32</b>
1" BSP	1"1/2 BSP	<b>A10201624</b>	<b>13,07</b>
1"1/4 BSP	1"1/2 BSP	<b>A10202024</b>	<b>10,69</b>
1"1/4 BSP	2" BSP	<b>A10202032</b>	<b>22,23</b>
1"1/2 BSP	2" BSP	<b>A10202432</b>	<b>20,24</b>
2" BSP	2" 1/2 BSP	<b>A10203240</b>	<b>40,85</b>
2" BSP	3" BSP	<b>A10203248</b>	<b>64,02</b>
2" 1/2 BSP	3" BSP	<b>A10204048</b>	<b>59,42</b>

## Adaptador macho BSP (60°) - macho NPT

Adaptor BSP male (60°)-NPT male

Adaptateur mâle BSP (60°) x mâle briggs (NPT)

Niples di congiunzione BSP (60°) - NPT

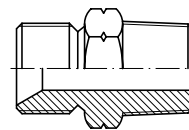

THREAD ROSCA		Part nº Referencia	€
1/8" BSP	1/8" NPT	<b>S101402</b>	<b>1,11</b>
1/4" BSP	1/4" NPT	<b>S101404</b>	<b>1,29</b>
3/8" BSP	3/8" NPT	<b>S101406</b>	<b>1,45</b>
1/2" BSP	1/2" NPT	<b>S101408</b>	<b>2,70</b>
3/4" BSP	3/4" NPT	<b>S101412</b>	<b>4,12</b>
1" BSP	1" NPT	<b>S101416</b>	<b>8,68</b>
1"1/4 BSP	1"1/4 NPT	<b>S101420</b>	<b>17,28</b>
1"1/2 BSP	1"1/2 NPT	<b>S101424</b>	<b>21,77</b>
2" BSP	2" NPT	<b>S101432</b>	<b>45,19</b>

## Adaptador macho BSP (60°) - macho BSPT

Adaptor BSP male- 60° BSPT male

Adaptateur mâle BSP (60°) x mâle gaz conique (BSPT)

Niples di congiunzione BSP (60°) - BSPT

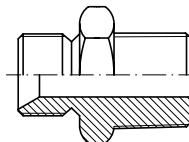

THREAD ROSCA		Part nº Referencia	€
1/8" BSP	1/8" BSPT	<b>S101202</b>	<b>1,22</b>
1/4" BSP	1/4" BSPT	<b>S101204</b>	<b>0,99</b>
3/8" BSP	3/8" BSPT	<b>S101206</b>	<b>1,14</b>
1/2" BSP	1/2" BSPT	<b>S101208</b>	<b>1,58</b>
3/4" BSP	3/4" BSPT	<b>S101212</b>	<b>2,89</b>
1" BSP	1" BSPT	<b>S101216</b>	<b>5,45</b>
1"1/4 BSP	1"1/4 BSPT	<b>S101220</b>	<b>11,63</b>
1"1/2 BSP	1"1/2 BSPT	<b>S101224</b>	<b>13,89</b>
2" BSP	2" BSPT	<b>S101232</b>	<b>27,15</b>

## Reductor macho BSP (60°) - macho BSPT

Reducer adaptor BSP male (60°)-BSPT male

Reducteur mâle BSP (60°) x mâle gaz conique (BSPT)

Niples di riduzione BSP (60°) - BSPT

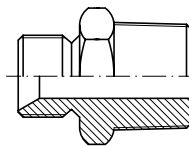

THREAD ROSCA		Part nº Referencia	€
1/4" BSP	3/8" BSPT	<b>A10220406</b>	<b>2,33</b>
3/8" BSP	1/2" BSPT	<b>A10220608</b>	<b>3,33</b>
3/8" BSP	3/4" BSPT	<b>A10220612</b>	<b>4,41</b>
1/2" BSP	1/4" BSPT	<b>A10220804</b>	<b>3,94</b>
1/2" BSP	3/4" BSPT	<b>A10220812</b>	<b>5,74</b>
3/4" BSP	1" BSPT	<b>A10221216</b>	<b>7,37</b>
1"1/4 BSP	1" BSPT	<b>A10222016</b>	<b>16,98</b>
1"1/2 BSP	2" BSPT	<b>A10222432</b>	<b>49,55</b>

# Adaptadores BSP , BSPT y Métricos

Metric, BSP and BSPT Adaptors  
Adaptateurs BSP, BSPT et Métrique  
Adattatori BSP, BSPT e Metrico

## Reductor macho BSP (60°) - macho NPT

Reducer adaptor BSP male (60°)-NPT male

Reducteur mâle BSP (60°) x mâle briggs (NPT)

Niples di riduzione BSP (60°) - NPT

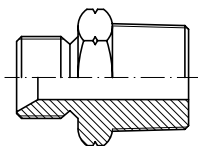

THREAD ROSCA		Part n° Referencia	€
1/4" BSP	1/8" NPT	<b>A10240402</b>	<b>2,33</b>
1/4" BSP	3/8" NPT	<b>A10240406</b>	<b>2,64</b>
1/4" BSP	1/2" NPT	<b>A10240408</b>	<b>3,88</b>
3/8" BSP	1/2" NPT	<b>A10240608</b>	<b>3,31</b>
1/2" BSP	3/8" NPT	<b>A10240806</b>	<b>4,18</b>
1/2" BSP	3/4" NPT	<b>A10240812</b>	<b>6,14</b>
3/4" BSP	1/2" NPT	<b>A10241208</b>	<b>7,13</b>
3/4" BSP	1" NPT	<b>A10241216</b>	<b>6,18</b>

## Adaptador macho-macho BSPT

Adaptor BSPT male-BSPT male

Adaptateur mâle gaz conique (BSPT) x mâle gaz conique (BSPT)

Niples di congiunzione BSPT

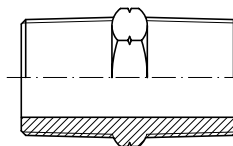

THREAD ROSCA		Part n° Referencia	€
1/4" BSPT	1/4" BSPT	<b>A10160404</b>	<b>1,02</b>
3/8" BSPT	3/8" BSPT	<b>A10160606</b>	<b>2,31</b>
1/2" BSPT	1/2" BSPT	<b>A10160808</b>	<b>2,95</b>
3/4" BSPT	3/4" BSPT	<b>A10161212</b>	<b>4,96</b>
1" BSPT	1" BSPT	<b>A10161616</b>	<b>6,33</b>

## Adaptador macho-macho Métrico (60°)

Adaptor Metric male-male (60°)

Adaptateur mâle DIN x mâle DIN Métrique (60°)

Niples di giunzione Metrico (60°)

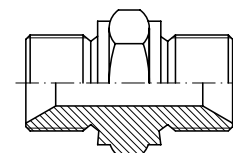

THREAD ROSCA		Part n° Referencia	€
M12x1.5	M12x1.5	<b>S101612</b>	<b>2,23</b>
M14x1.5	M14x1.5	<b>S101614</b>	<b>1,66</b>
M16x1.5	M16x1.5	<b>S101616</b>	<b>1,73</b>
M18x1.5	M18x1.5	<b>S101618</b>	<b>1,98</b>
M22x1.5	M22x1.5	<b>S101622</b>	<b>3,16</b>
M26x1.5	M26x1.5	<b>S101626</b>	<b>5,57</b>

# Adaptadores BSP , BSPT y Métricos

Metric, BSP and BSPT Adaptors  
Adaptateurs BSP, BSPT et Métrique  
Adattatori BSP, BSPT e Metrico

## Adap. macho - hembra giratoria BSP (60°)

Adaptor BSP male-BSP swivel female (60°)

Adaptateur mâle BSP x femelle tournante BSP (60°)

Nipples maschio-femmina girevole BSP (60°)

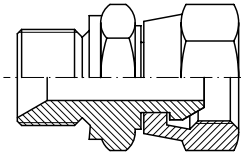

THREAD ROSCA		Part nº Referencia	€
1/8" BSP	1/8" BSP	<b>A117002</b>	<b>2,79</b>
1/4" BSP	1/4" BSP	<b>A117004</b>	<b>2,16</b>
3/8" BSP	3/8" BSP	<b>A117006</b>	<b>2,23</b>
1/2" BSP	1/2" BSP	<b>A117008</b>	<b>3,44</b>
3/4" BSP	3/4" BSP	<b>A117012</b>	<b>4,87</b>
1" BSP	1" BSP	<b>A117016</b>	<b>9,10</b>
1"1/4 BSP	1"1/4 BSP	<b>A117020</b>	<b>19,13</b>
1"1/2 BSP	1"1/2 BSP	<b>A117024</b>	<b>23,51</b>
2" BSP	2" BSP	<b>A117032</b>	<b>47,41</b>

## Reductor macho - hembra giratoria BSP (60°)

Reducer BSP male-BSP swivel female (60°)

Reducteur mâle BSP x femelle tournante BSP (60°)

Nipples di riduzione maschio-femmina girevole BSP (60°)

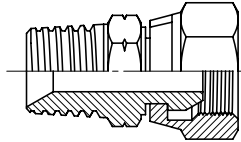

THREAD ROSCA		Part nº Referencia	€
M 1/8" BSP	F 1/4" BSP	<b>A11730204</b>	<b>2,59</b>
M 1/4" BSP	F 1/8" BSP	<b>A11730402</b>	<b>2,29</b>
M 1/4" BSP	F 3/8" BSP	<b>A11730406</b>	<b>2,59</b>
M 3/8" BSP	F 1/4" BSP	<b>A11730604</b>	<b>2,86</b>
M 1/2" BSP	F 3/8" BSP	<b>A11730806</b>	<b>3,95</b>
M 3/4" BSP	F 1/2" BSP	<b>A11731208</b>	<b>5,66</b>
M 1" BSP	F 3/4" BSP	<b>A11731612</b>	<b>7,73</b>
M 3/8" BSP	F 1/2" BSP	<b>A11730608</b>	<b>3,30</b>
M 1/2" BSP	F 3/4" BSP	<b>A11730812</b>	<b>4,39</b>
M 3/4" BSP	F 1" BSP	<b>A11731216</b>	<b>8,10</b>
M 3/4" BSP	F 1"1/4 BSP	<b>A11731220</b>	<b>13,73</b>
M 1" BSP	F 1"1/4 BSP	<b>A11731620</b>	<b>18,99</b>
M 1"1/4 BSP	F 1"1/2 BSP	<b>A11732024</b>	<b>36,00</b>
M 1" 1/2 BSP	F 2" BSP	<b>A11732432</b>	<b>52,49</b>

## Prolongador macho (60°) - hembra fija BSP

Adaptor BSP male (60°) - BSP fixed female

Prolongateur mâle BSP (60°) x femelle gaz fixe

Prolunga maschio (60°) - femmina BSP

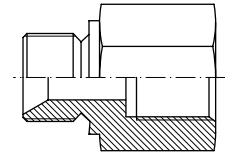

THREAD ROSCA		Part nº Referencia	€
1/8" BSP	1/8" BSP	<b>A105002</b>	<b>0,81</b>
1/8" BSP	1/8" BSP	<b>A105002L38</b>	<b>1,41</b>
1/4" BSP	1/4" BSP	<b>A105004</b>	<b>1,08</b>
1/4" BSP	1/4" BSP	<b>A105004L46</b>	<b>2,15</b>
1/4" BSP	1/4" BSP	<b>A105004L56</b>	<b>2,01</b>
3/8" BSP	3/8" BSP	<b>A105006</b>	<b>1,43</b>
3/8" BSP	3/8" BSP	<b>A105006L44</b>	<b>2,38</b>
3/8" BSP	3/8" BSP	<b>A105006L54</b>	<b>2,97</b>
1/2" BSP	1/2" BSP	<b>A105008</b>	<b>2,29</b>
1/2" BSP	1/2" BSP	<b>A105008L50</b>	<b>2,89</b>
1/2" BSP	1/2" BSP	<b>A105008L60</b>	<b>3,10</b>
3/4" BSP	3/4" BSP	<b>A105012</b>	<b>3,22</b>
3/4" BSP	3/4" BSP	<b>A105012L72</b>	<b>5,94</b>
1" BSP	1" BSP	<b>A105016</b>	<b>5,06</b>
1" BSP	1" BSP	<b>A105016L84</b>	<b>10,77</b>
1"1/4 BSP	1"1/4 BSP	<b>A105020</b>	<b>10,79</b>
1"1/4 BSP	1"1/4 BSP	<b>A105020L92</b>	<b>14,85</b>
1"1/2 BSP	1"1/2 BSP	<b>A105024</b>	<b>14,85</b>
1"1/2 BSP	1"1/2 BSP	<b>A105024L100</b>	<b>22,28</b>
2" BSP	2" BSP	<b>A105032</b>	<b>24,10</b>
2" BSP	2" BSP	<b>A105032L100</b>	<b>34,91</b>

## Reductor macho BSP (60°) - hembra fija Métrica

Reducer adaptor BSP male (60°) - Metric fixed female

Reducteur mâle BSP (60°) x femelle fixe Métrique

Nipples di riduzione maschio BSP (60°)-femmina fissa Metrica

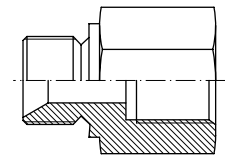

THREAD ROSCA		Part nº Referencia	€
3/8" BSP	M14x1.5	<b>S10610614</b>	<b>3,96</b>
3/8" BSP	M18x1.5	<b>S10610618</b>	<b>3,29</b>
1/2" BSP	M18x1.5	<b>S10610818</b>	<b>3,91</b>
1/2" BSP	M22x1.5	<b>S10610822</b>	<b>3,91</b>

## Reductor macho métrico (60°) - hembra fija BSP

Reducer adaptor Metric male - BSP fixed female

Reducteur mâle Métrique (60°) x femelle fixe gaz

Nipples di riduzione maschio Metrico (60°)-femmina fissa BSP

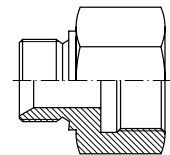

THREAD ROSCA		Part nº Referencia	€
M18x1.5	1/4" BSP	<b>S10621804</b>	<b>3,89</b>
M18x1.5	3/8" BSP	<b>S10621806</b>	<b>3,89</b>
M18x1.5	1/2" BSP	<b>S10621808</b>	<b>4,49</b>

# Adaptadores BSP , BSPT y Métricos

Metric, BSP and BSPT Adaptors  
Adaptateurs BSP, BSPT et Métrique  
Adattatori BSP, BSPT e Metrico

## Adap. hembra giratoria - hembra giratoria BSP (60°)

Adaptor BSP swivel female - BSP swivel female (60°)

Adaptateur femelle tournante BSP x femelle tournante BSP (60°)

Nipples feminas-femmina girevole BSP (60°)

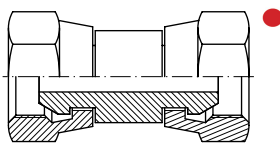

THREAD ROSCA		Part nº Referencia	€
1/4" BSP	1/4" BSP	<b>A117204</b>	<b>2,90</b>
3/8" BSP	3/8" BSP	<b>A117206</b>	<b>3,59</b>
1/2" BSP	1/2" BSP	<b>A117208</b>	<b>5,66</b>
3/4" BSP	3/4" BSP	<b>A117212</b>	<b>7,24</b>
1" BSP	1" BSP	<b>A117216</b>	<b>11,76</b>
1"1/4 BSP	1"1/4 BSP	<b>A117220</b>	<b>36,75</b>
1"1/2 BSP	1"1/2 BSP	<b>A117224</b>	<b>53,77</b>
2" BSP	2" BSP	<b>A117232</b>	<b>133,18</b>

## Reductor macho BSP (60°) - hembra fija BSP

Reducer adaptor BPS male (60°) - BSP fixed female

Prolongateur reducteur mâle BSP (60°) x femelle gaz fixe

Prolunga di riduzione maschio (60°) - femmina BSP

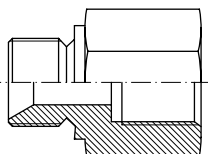

THREAD ROSCA		Part nº Referencia	€
M 1/8" BSP	F 1/4" BSP	<b>A10600204</b>	<b>1,24</b>
M 1/8" BSP	F 3/8" BSP	<b>A10600206</b>	<b>2,07</b>
M 1/4" BSP	F 1/8" BSP	<b>A10600402</b>	<b>1,23</b>
M 1/4" BSP	F 3/8" BSP	<b>A10600406</b>	<b>1,71</b>
M 1/4" BSP	F 1/2" BSP	<b>A10600408</b>	<b>2,41</b>
M 3/8" BSP	F 1/8" BSP	<b>A10600602</b>	<b>2,55</b>
M 3/8" BSP	F 1/4" BSP	<b>A10600604</b>	<b>1,65</b>
M 3/8" BSP	F 1/2" BSP	<b>A10600608</b>	<b>2,24</b>
M 3/8" BSP	F 3/4" BSP	<b>A10600612</b>	<b>3,10</b>
M 1/2" BSP	F 1/4" BSP	<b>A10600804</b>	<b>2,86</b>
M 1/2" BSP	F 3/8" BSP	<b>A10600806</b>	<b>2,27</b>
M 1/2" BSP	F 3/4" BSP	<b>A10600812</b>	<b>3,17</b>
M 1/2" BSP	F 1" BSP	<b>A10600816</b>	<b>5,72</b>
M 3/4" BSP	F 3/8" BSP	<b>A10601206</b>	<b>3,73</b>
M 3/4" BSP	F 1/2" BSP	<b>A10601208</b>	<b>3,42</b>
M 3/4" BSP	F 1" BSP	<b>A10601216</b>	<b>5,85</b>
M 3/4" BSP	F 1"1/4 BSP	<b>A10601220</b>	<b>10,93</b>
M 1" BSP	F 1/2" BSP	<b>A10601608</b>	<b>5,51</b>
M 1" BSP	F 3/4" BSP	<b>A10601612</b>	<b>5,65</b>
M 1" BSP	F 1"1/4 BSP	<b>A10601620</b>	<b>10,29</b>
M 1"1/4 BSP	F 1" BSP	<b>A10602016</b>	<b>10,93</b>
M 1"1/4 BSP	F 1" 1/2 BSP	<b>A10602024</b>	<b>15,60</b>
M 1"1/2 BSP	F 1"1/4 BSP	<b>A10602420</b>	<b>27,41</b>
M 1"1/2 BSP	F 2" BSP	<b>A10602432</b>	<b>60,94</b>

## Tapón reductor macho (60°) - hembra fija BSP

Reducer plug BSP male (60°) - BSP fixed female

Bouchon reducteur mâle BSP (60°) x femelle gaz fixe

Tappo di riduzione maschio (60°) - femmina BSP

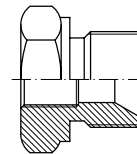

THREAD ROSCA		Part nº Referencia	€
M 1/4" BSP	F 1/8" BSP	<b>A11500402</b>	<b>1,00</b>
M 3/8" BSP	F 1/8" BSP	<b>A11500602</b>	<b>1,49</b>
M 3/8" BSP	F 1/4" BSP	<b>A11500604</b>	<b>1,05</b>
M 1/2" BSP	F 1/4" BSP	<b>A11500804</b>	<b>1,75</b>
M 1/2" BSP	F 3/8" BSP	<b>A11500806</b>	<b>1,61</b>
M 3/4" BSP	F 3/8" BSP	<b>A11501206</b>	<b>2,21</b>
M 3/4" BSP	F 1/2" BSP	<b>A11501208</b>	<b>2,65</b>
M 1" BSP	F 1/2" BSP	<b>A11501608</b>	<b>3,69</b>
M 1" BSP	F 3/4" BSP	<b>A11501612</b>	<b>3,51</b>
M 1"1/4 BSP	F 3/4" BSP	<b>A11502012</b>	<b>6,85</b>
M 1"1/4 BSP	F 1" BSP	<b>A11502016</b>	<b>6,01</b>
M 1"1/2 BSP	F 1"1/4 BSP	<b>A11502420</b>	<b>10,10</b>
M 2" BSP	F 1" 1/4 BSP	<b>A11503220</b>	<b>24,52</b>
M 2" BSP	F 1"1/2 BSP	<b>A11503224</b>	<b>24,52</b>

## Adaptador hembra giratoria BSP (60°) - Macho BSPT

Adaptor BSP swivel female (60°) - BSPT male

Adaptateur femelle tournante BSP (60°) x mâle BSPT

Nipples femmina girevole BSP (60°)-maschio BSPT

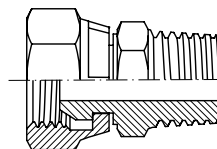

THREAD ROSCA		Part nº Referencia	€
M 1/4" BSPT	F 1/4" BSP	<b>A11710404</b>	<b>4,35</b>
M 3/8" BSPT	F 3/8" BSP	<b>A11710606</b>	<b>4,73</b>
M 1/2" BSPT	F 1/2" BSP	<b>A11710808</b>	<b>6,05</b>
M 3/4" BSPT	F 3/4" BSP	<b>A11711212</b>	<b>9,46</b>
M 1" BSPT	F 1" BSP	<b>A11711616</b>	<b>15,20</b>

## Adaptador macho BSP (60°) - Hembra Fija NPT

Adaptor BSP male (60°) - NPT fixed female

Adaptateur mâle BSP (60°) x femelle fixe NPT

Nipples di riduzione maschio (60°) - femmina NPT

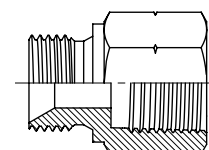

THREAD ROSCA		Part nº Referencia	€
M 1/4" BSP	F 1/4" NPT	<b>A107404</b>	<b>2,66</b>
M 3/8" BSP	F 3/8" NPT	<b>A107406</b>	<b>3,62</b>
M 1/2" BSP	F 1/2" NPT	<b>A107408</b>	<b>5,43</b>
M 3/4" BSP	F 3/4" NPT	<b>A107412</b>	<b>8,14</b>
M 1" BSP	F 1" NPT	<b>A107416</b>	<b>12,07</b>

# Adaptadores BSP , BSPT y Métricos

Metric, BSP and BSPT Adaptors  
Adaptateurs BSP, BSPT et Métrique  
Adattatori BSP, BSPT e Metrico

Quick-release couplings

Ball valves

Diversers

Swivel fittings

Multi-way couplings

Protections

## Tapón hembra hexagonal rosca BSP

BSP fixed cap

Bouchon femelle gaz

Tappo femmina fissa BSP

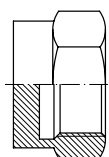

THREAD ROSCA	Part nº Referencia	€
1/8" BSP	<b>A107202</b>	<b>1,38</b>
1/4" BSP	<b>A107204</b>	<b>1,17</b>
3/8" BSP	<b>A107206</b>	<b>1,45</b>
1/2" BSP	<b>A107208</b>	<b>2,08</b>
3/4" BSP	<b>A107212</b>	<b>2,78</b>
1" BSP	<b>A107216</b>	<b>4,52</b>
1"1/4 BSP	<b>A107220</b>	<b>13,48</b>
1"1/2 BSP	<b>A107224</b>	<b>30,21</b>
2" BSP	<b>A107232</b>	<b>45,68</b>

## Tapón macho hexagonal rosca BSP (60°)

BSP hexagonal male plug (60°)

Bouchon mâle BSP (60°)

Tappo maschio esagonale BSP (60°)

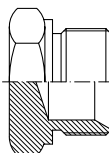

THREAD ROSCA	Part nº Referencia	€
1/8" BSP	<b>A107002</b>	<b>0,66</b>
1/4" BSP	<b>A107004</b>	<b>0,75</b>
1/4" BSP	<b>A107004H19</b>	<b>0,77</b>
3/8" BSP	<b>A107006</b>	<b>1,04</b>
1/2" BSP	<b>A107008</b>	<b>1,51</b>
5/8" BSP	<b>A107010</b>	<b>2,90</b>
3/4" BSP	<b>A107012</b>	<b>2,16</b>
1" BSP	<b>A107016</b>	<b>3,86</b>
1"1/4 BSP	<b>A107020</b>	<b>8,71</b>
1"1/2 BSP	<b>A107024</b>	<b>11,42</b>
2" BSP	<b>A107032</b>	<b>17,87</b>

## Tapón hembra giratoria BSP (60°)

BSP swivel female cap (60°)

Bouchon femelle tournante BSP (60°)

Tappo femmina girevole BSP (60°)

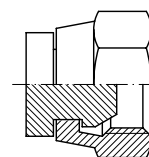

THREAD ROSCA	Part nº Referencia	€
1/4" BSP	<b>A107504</b>	<b>1,46</b>
3/8" BSP	<b>A107506</b>	<b>1,73</b>
1/2" BSP	<b>A107508</b>	<b>2,39</b>
3/4" BSP	<b>A107512</b>	<b>3,23</b>
1" BSP	<b>A107516</b>	<b>4,83</b>
1"1/4 BSP	<b>A107520</b>	<b>12,48</b>
1"1/2 BSP	<b>A107524</b>	<b>18,14</b>
2" BSP	<b>A107532</b>	<b>30,01</b>

## Tapón macho hexagonal rosca Métrica

Metric hexagonal male plug

Bouchon mâle Métrique

Tappo maschio esagonale Metrico

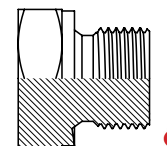

THREAD ROSCA	Part nº Referencia	€
M10x1	<b>A10731001</b>	<b>0,78</b>
M12x1.5	<b>A10731215</b>	<b>0,98</b>
M14x1.5	<b>A10731415</b>	<b>0,91</b>
M16x1.5	<b>A10731615</b>	<b>1,17</b>
M18x1.5	<b>A10731815</b>	<b>1,51</b>
M20x1.5	<b>A10732015</b>	<b>1,58</b>
M22x1.5	<b>A10732215</b>	<b>1,56</b>

## Tapón Allen BSPT sin cabeza

BSPT blanking plug

Bouchon Allen BSPT

Tappo conico BSPT

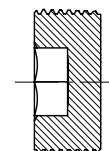

THREAD ROSCA	Part nº Referencia	€
1/8" BSPT	<b>A107102</b>	<b>0,65</b>
1/4" BSPT	<b>A107104</b>	<b>0,88</b>
3/8" BSPT	<b>A107106</b>	<b>1,17</b>
1/2" BSPT	<b>A107108</b>	<b>1,56</b>
3/4" BSPT	<b>A107112</b>	<b>2,81</b>
1" BSPT	<b>A107116</b>	<b>3,50</b>

# Adaptadores BSP , BSPT y Métricos

Metric, BSP and BSPT Adaptors  
Adaptateurs BSP, BSPT et Métrique  
Adattatori BSP, BSPT e Metrico

Adaptors

## Manguito roscado hembra BSP redondo soldable

Welding adaptor BSP female fixed-BSP female fixed

Manchon femelle à souder gaz x femelle gaz ronde

Manicoto femmina - femmina a saldare BSP

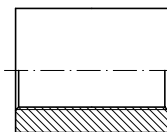

THREAD ROSCA	Part nº Referencia	€
1/8" BSP	<b>A131002</b>	<b>0,94</b>
1/4" BSP	<b>A131004</b>	<b>1,13</b>
3/8" BSP	<b>A131006</b>	<b>1,53</b>
1/2" BSP	<b>A131008</b>	<b>2,13</b>
3/4" BSP	<b>A131012</b>	<b>2,97</b>
1" BSP	<b>A131016</b>	<b>4,39</b>
1"1/4 BSP	<b>A131020</b>	<b>7,17</b>
1"1/2 BSP	<b>A131024</b>	<b>9,68</b>
2" BSP	<b>A131032</b>	<b>14,73</b>

## Manguito roscado hembra BSP hexagonal

Hexagonal adaptor BSP fixed female-BSP fixed female

Manchon femelle gaz x femelle gaz hexagonal

Prolunga esagonale femmina-femmina BSP

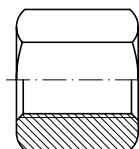

THREAD ROSCA	Part nº Referencia	€
1/4" BSP	<b>S1031004</b>	<b>0,97</b>
3/8" BSP	<b>S1031006</b>	<b>2,00</b>
1/2" BSP	<b>S1031008</b>	<b>2,15</b>
3/4" BSP	<b>S1031012</b>	<b>3,47</b>
1" BSP	<b>S1031016</b>	<b>4,13</b>
1"1/4 BSP	<b>S1031020</b>	<b>15,45</b>
1"1/2 BSP	<b>S1031024</b>	<b>19,31</b>

## Pasatabiques sin tuerca BSP cono 60°

Straight bulkhead adaptor without nuts (60°)

Passe-cloison mâle BSP x mâle BSP sans équiper (60°)

Nipples passaparete BSP

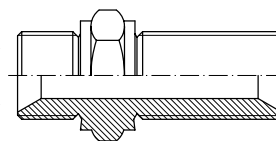

THREAD ROSCA		Part nº Referencia	€
1/4" BSP	1/4" BSP	<b>A116004</b>	<b>1,77</b>
3/8" BSP	3/8" BSP	<b>A116006</b>	<b>2,15</b>
1/2" BSP	1/2" BSP	<b>A116008</b>	<b>3,12</b>
3/4" BSP	3/4" BSP	<b>A116012</b>	<b>5,38</b>
1" BSP	1" BSP	<b>A116016</b>	<b>8,77</b>
1"1/4 BSP	1"1/4 BSP	<b>A116020</b>	<b>13,50</b>
1"1/2 BSP	1"1/2 BSP	<b>A116024</b>	<b>15,70</b>

## Tuerca pasatabiques BSP

Counter nut for bulkhead screw-joints

Contre-écrou passe-cloison gaz

Controdado per passaparete BSP

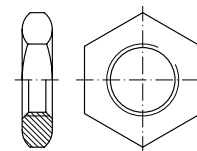

THREAD ROSCA	Part nº Referencia	€
1/8" BSP	<b>A127202</b>	<b>1,30</b>
1/4" BSP	<b>A127204</b>	<b>0,48</b>
3/8" BSP	<b>A127206</b>	<b>0,68</b>
1/2" BSP	<b>A127208</b>	<b>0,95</b>
3/4" BSP	<b>A127212</b>	<b>1,18</b>
1" BSP	<b>A127216</b>	<b>2,87</b>
1" 1/4 BSP	<b>A127220</b>	<b>4,13</b>
1" 1/2 BSP	<b>A127224</b>	<b>4,62</b>

Quick-release couplings

Ball valves

Diverters

Swivel fittings

Multi-way couplings

Protections

# Adaptadores BSP , BSPT y Métricos

Metric, BSP and BSPT Adaptors  
Adaptateurs BSP, BSPT et Métrique  
Adattatori BSP, BSPT e Metrico

## Tornillo orientable simple BSP

BSP Bolt for banjo

Vis creuse simple pour banjo filetage gaz

Bullone forato BSP

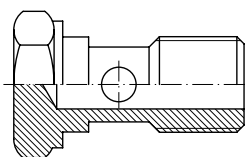

THREAD ROSCA	Part nº Referencia	€
1/8" BSP	<b>A109002</b>	<b>1,14</b>
1/4" BSP	<b>A109004</b>	<b>1,14</b>
3/8" BSP	<b>A109006</b>	<b>1,45</b>
1/2" BSP	<b>A109008</b>	<b>2,23</b>
5/8" BSP	<b>A109010</b>	<b>2,60</b>
3/4" BSP	<b>A109012</b>	<b>3,87</b>
1" BSP	<b>A109016</b>	<b>6,27</b>
1 1/4" BSP	<b>A109020</b>	<b>34,18</b>
1 1/2" BSP	<b>A109024</b>	<b>87,21</b>

## Tornillo orientable doble BSP

BSP Double bolt for banjo

Vis creuse double pour banjo filetage gaz

Bullone forato doppio BSP

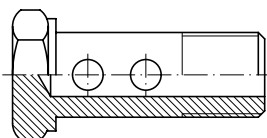

THREAD ROSCA	Part nº Referencia	€
1/4" BSP	<b>A109404</b>	<b>2,42</b>
3/8" BSP	<b>A109406</b>	<b>2,93</b>
1/2" BSP	<b>A109408</b>	<b>4,71</b>
3/4" BSP	<b>A109412</b>	<b>8,46</b>
1" BSP	<b>A109416</b>	<b>17,61</b>

## Tornillo orientable prolongado BSP

BSP Extended bolt for banjo

Vis creuse simple prolongée pour banjo

Bullone forato prolungato BSP

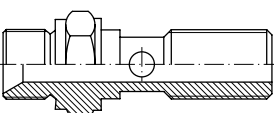

THREAD ROSCA	Part nº Referencia	€	
1/4" BSP	1/4" BSP	<b>A109204</b>	<b>2,89</b>
3/8" BSP	3/8" BSP	<b>A109206</b>	<b>3,70</b>
1/2" BSP	1/2" BSP	<b>A109208</b>	<b>5,03</b>
3/4" BSP	3/4" BSP	<b>A109212</b>	<b>7,19</b>
1" BSP	1" BSP	<b>A109216</b>	<b>14,27</b>

## Tornillo orientable reductor BSP

BSP Reducer bolt for banjo

Vis creuse simple reduite pour banjo x mâle BSP

Bullone forato di riduzione BSP

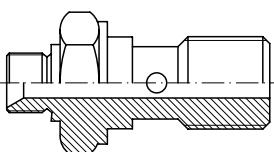

THREAD ROSCA	Part nº Referencia	€	
1/4" BSP	3/8" BSP	<b>A10930406</b>	<b>3,70</b>
3/8" BSP	1/2" BSP	<b>A10930608</b>	<b>5,03</b>
1/2" BSP	3/4" BSP	<b>A10930812</b>	<b>7,19</b>
3/4" BSP	1" BSP	<b>A10931216</b>	<b>14,27</b>

## Tornillo orientable simple rosca Métrica

Metric bolt for banjo

Vis creuse simple pour banjo filetage Métrique

Bullone forato Metrico

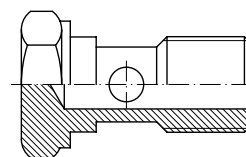

THREAD ROSCA	Part nº Referencia	€
M8x1	<b>S109208</b>	<b>1,03</b>
M10x1	<b>S109210</b>	<b>1,03</b>
M12x1.5	<b>S109212</b>	<b>1,17</b>
M14x1.5	<b>S109214</b>	<b>1,38</b>
M16x1.5	<b>S109216</b>	<b>1,76</b>
M18x1.5	<b>S109218</b>	<b>1,84</b>
M22x1.5	<b>S109222</b>	<b>2,45</b>
M26x1.5	<b>S109226</b>	<b>4,04</b>
M30x1.5	<b>S109230</b>	<b>8,72</b>

## Tornillo orientable doble rosca Métrica

Metric double bolt for banjo

Vis creuse double pour banjo filetage Métrique

Bullone forato doppio Metrico

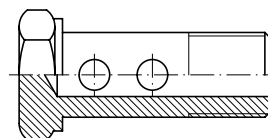

THREAD ROSCA	Part nº Referencia	€
M8x1	<b>A10960801</b>	<b>2,96</b>
M10x1	<b>A10961001</b>	<b>1,91</b>
M12x1.5	<b>A10961215</b>	<b>3,49</b>
M14x1.5	<b>A10961415</b>	<b>2,83</b>
M18x1.5	<b>A10961815</b>	<b>4,85</b>

## Esférico BSP - macho BSP (60°)

BSP Banjo-BSP male (60°)

Banjo passage gaz x mâle BSP (60°)

Adattatore ad ochhio filettato BSP

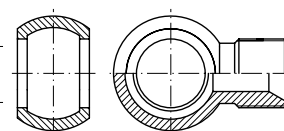

THREAD ROSCA	Ø	Part nº Referencia	€
1/8" BSP	1/8"	<b>A114002</b>	<b>3,08</b>
1/4" BSP	1/4"	<b>A114004</b>	<b>2,00</b>
3/8" BSP	3/8"	<b>A114006</b>	<b>3,21</b>
1/2" BSP	1/2"	<b>A114008</b>	<b>3,71</b>
3/4" BSP	3/4"	<b>A114012</b>	<b>10,85</b>
1" BSP	1"	<b>A114016</b>	<b>37,28</b>

## Esférico BSP con alargadera-macho BSP (60°)

BSP Banjo with extension-BSP male 60°

Banjo prolongé passage gaz x mâle BSP 60°

Adattatore ad occhio con prolunga maschio 60°

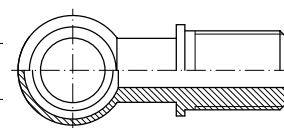

THREAD ROSCA	Ø	Part nº Referencia	€
3/8" BSP	3/8"	<b>A111206</b>	<b>6,31</b>
1/2" BSP	3/8"	<b>A11120608</b>	<b>12,09</b>
1/2" BSP	1/2"	<b>A111208</b>	<b>12,11</b>

# Adaptadores BSP , BSPT y Métricos

Metric, BSP and BSPT Adaptors  
Adaptateurs BSP, BSPT et Métrique  
Adattatori BSP, BSPT e Metrico

Adaptors

Quick-release couplings

Ball valves

Diverters

Swivel fittings

Multi-way couplings

Protections

## Esférico BSP con alargadera-hembra giratoria BSP

BSP Banjo with extension-BSP swivel female

Banjo prolongé passage gaz femelle tournante

Adattatore ad occhio con prolunga femmina girevole

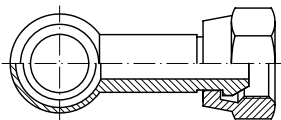

THREAD ROSCA	Ø	Part n° Referencia	€
1/2" BSP	1/2"	<b>A111108</b>	<b>15,56</b>

## Esférico BSP con alargadera-hembra fija BSP

BSP Banjo with extension-BSP fixed female

Banjo prolongé passage gaz x femelle fixe BSP

Adattatore ad occhio con prolunga femmina fissa

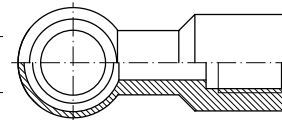

THREAD ROSCA	Ø	Part n° Referencia	€
3/8" BSP	3/8"	<b>A111306</b>	<b>6,36</b>
1/2" BSP	1/2"	<b>A111308</b>	<b>14,25</b>

## Empalme liso soldable rosca BSP (60°)

Welding union BSP male (60°)

Embout mâle lisse à souder gaz cyl BSP (60°)

Mezzo nipples tondo a saldare BSP

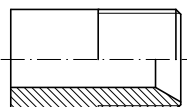

THREAD ROSCA	Part n° Referencia	€
1/8" BSP	<b>A129002</b>	<b>1,36</b>
1/4" BSP	<b>A129004</b>	<b>0,79</b>
3/8" BSP	<b>A129006</b>	<b>1,00</b>
1/2" BSP	<b>A129008</b>	<b>1,22</b>
3/4" BSP	<b>A129012</b>	<b>2,22</b>
1" BSP	<b>A129016</b>	<b>5,16</b>
1"1/4 BSP	<b>A129020</b>	<b>15,41</b>
1"1/2 BSP	<b>A129024</b>	<b>16,87</b>
2" BSP	<b>A129032</b>	<b>16,71</b>

## Racor macho BSP (60°) soldable interior

Welding adaptor BSP male (60°) (internal welding)

Mamelon BSP hexagone à souder intérieur sw (60°)

Raccordo maschio BSP a saldare di tasca

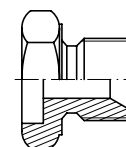

THREAD ROSCA	Part n° Referencia	€
1/8" BSP	<b>A103102</b>	<b>1,56</b>
1/4" BSP	<b>A103104</b>	<b>1,00</b>
3/8" BSP	<b>A103106</b>	<b>1,21</b>
1/2" BSP	<b>A103108</b>	<b>2,33</b>
3/4" BSP	<b>A103112</b>	<b>3,59</b>
1" BSP	<b>A103116</b>	<b>6,16</b>
1"1/4 BSP	<b>A103120</b>	<b>14,51</b>
1"1/2 BSP	<b>A103124</b>	<b>19,06</b>
2" BSP	<b>A103132</b>	<b>24,39</b>

## Racor macho BSP (60°) soldable exterior

Welding adaptor BSP male (60°) (external welding)

Mamelon BSP hexagone à souder extérieur bw (60°)

Raccordo maschio BSP a saldare

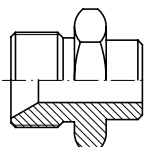

THREAD ROSCA	Part n° Referencia	€
1/8" BSP	<b>A103002</b>	<b>1,68</b>
1/4" BSP	<b>A103004</b>	<b>1,04</b>
3/8" BSP	<b>A103006</b>	<b>1,40</b>
1/2" BSP	<b>A103008</b>	<b>1,79</b>
3/4" BSP	<b>A103012</b>	<b>2,99</b>
1" BSP	<b>A103016</b>	<b>4,45</b>
1"1/4 BSP	<b>A103020</b>	<b>10,47</b>
1"1/2 BSP	<b>A103024</b>	<b>13,40</b>
2" BSP	<b>A103032</b>	<b>20,42</b>

## Esférico BSP soldable exterior

BSP Banjo external welding

Banjo passage gaz à souder extérieur (bw)

Raccordo a occhio BSP a saldare

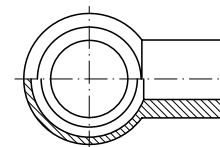

THREAD ROSCA	Ø	Part n° Referencia	€
1/8" BSP	1/8"	<b>A114102</b>	<b>1,23</b>
1/4" BSP	1/4"	<b>A114104</b>	<b>1,90</b>
3/8" BSP	3/8"	<b>A114106</b>	<b>2,94</b>
1/2" BSP	1/2"	<b>A114108</b>	<b>4,90</b>
3/4" BSP	3/4"	<b>A114112</b>	<b>11,26</b>
1" BSP	1"	<b>A114116</b>	<b>33,39</b>

## Soldables para cilindros

Welding nipples for cylinders

Raccords à souder pour verins

Borchia a saldare femmina-femmina

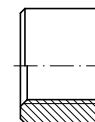

THREAD ROSCA	Part n° Referencia	€
1/4" BSP	<b>A13110400000</b>	<b>0,76</b>
3/8" BSP	<b>A13110600000</b>	<b>1,07</b>
1/2" BSP	<b>A13110800000</b>	<b>1,23</b>
3/4" BSP	<b>A13111200000</b>	<b>3,03</b>

# Adaptadores BSP , BSPT y Métricos

Metric, BSP and BSPT Adaptors  
Adaptateurs BSP, BSPT et Métrique  
Adattatori BSP, BSPT e Metrico

## Codo 90° macho-hembra giratoria BSP (60°)

90° Elbow BSP swivel female-male

Adapteur coude 90° mâle BSP x femelle tournante BSP (60°)

Curva 90° maschio-femmina girevole BSP 60°

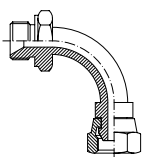

THREAD ROSCA		Part nº Referencia	€
1/4" BSP	1/4" BSP	<b>A119404</b>	<b>3,38</b>
3/8" BSP	3/8" BSP	<b>A119406</b>	<b>4,46</b>
1/2" BSP	1/2" BSP	<b>A119408</b>	<b>6,31</b>
3/4" BSP	3/4" BSP	<b>A119412</b>	<b>8,60</b>
1" BSP	1" BSP	<b>A119416</b>	<b>13,37</b>
1" 1/4 BSP	1" 1/4 BSP	<b>A119420</b>	<b>21,70</b>
1" 1/2 BSP	1" 1/2 BSP	<b>A119424</b>	<b>45,24</b>
2" BSP	2" BSP	<b>A119432</b>	<b>66,07</b>

## Codo 45° macho-hembra giratoria BSP (60°)

45° Elbow BSP swivel female-male

Adapteur coude 45° mâle BSP x femelle tournante BSP (60°)

Curva 45° maschio-femmina girevole BSP 60°

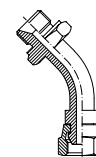

THREAD ROSCA		Part nº Referencia	€
1/4" BSP	1/4" BSP	<b>A119504</b>	<b>3,30</b>
3/8" BSP	3/8" BSP	<b>A119506</b>	<b>3,86</b>
1/2" BSP	1/2" BSP	<b>A119508</b>	<b>4,02</b>
3/4" BSP	3/4" BSP	<b>A119512</b>	<b>8,28</b>
1" BSP	1" BSP	<b>A119516</b>	<b>12,78</b>
1" 1/4 BSP	1" 1/4 BSP	<b>A119520</b>	<b>21,70</b>
1" 1/2 BSP	1" 1/2 BSP	<b>A119524</b>	<b>45,24</b>
2" BSP	2" BSP	<b>A119532</b>	<b>65,89</b>

## Codo 90° hembra giratoria-hembra giratoria BSP (60°)

90° Elbow BSP swivel female-BSP swivel female

Adapteur coude 90° femelle tournante BSP x femelle tournante BSP (60°)

Curva 90° femmina-femmina girevole BSP 60°

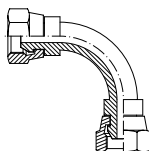

THREAD ROSCA		Part nº Referencia	€
1/4" BSP	1/4" BSP	<b>A119604</b>	<b>3,49</b>
3/8" BSP	3/8" BSP	<b>A119606</b>	<b>3,85</b>
1/2" BSP	1/2" BSP	<b>A119608</b>	<b>5,22</b>
3/4" BSP	3/4" BSP	<b>A119612</b>	<b>9,18</b>
1" BSP	1" BSP	<b>A119616</b>	<b>14,05</b>
1" 1/4 BSP	1" 1/4 BSP	<b>A119620</b>	<b>24,11</b>
1" 1/2 BSP	1" 1/2 BSP	<b>A119624</b>	<b>52,95</b>
2" BSP	2" BSP	<b>A119632</b>	<b>76,33</b>

# Adaptadores BSP , BSPT y Métricos

Metric, BSP and BSPT Adaptors  
Adaptateurs BSP, BSPT et Métrique  
Adattatori BSP, BSPT e Metrico

Adaptors

Quick-release couplings

Ball valves

Diverters

Swivel fittings

Multi-way couplings

Protections

## Codo 90° macho-macho BSP (60°) forja

90° Elbow BSP male (60°)-BSP male (60°) forge

Adapteur coude 90° mâle BSP x mâle BSP (60°) forge

Adattatore a 90° maschio-maschio BSP (60°) forgiato

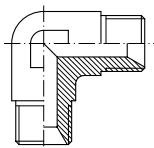

THREAD ROSCA		Part nº Referencia	€
1/8" BSP	1/8" BSP	<b>S119002</b>	<b>2,84</b>
1/4" BSP	1/4" BSP	<b>S119004</b>	<b>2,51</b>
3/8" BSP	3/8" BSP	<b>S119006</b>	<b>3,28</b>
1/2" BSP	1/2" BSP	<b>S119008</b>	<b>4,14</b>
3/4" BSP	3/4" BSP	<b>S119012</b>	<b>6,59</b>
1" BSP	1" BSP	<b>S119016</b>	<b>13,47</b>
1"1/4 BSP	1"1/4 BSP	<b>S119020</b>	<b>33,45</b>
1" 1/2 BSP	1" 1/2 BSP	<b>S119024</b>	<b>40,06</b>
2" BSP	2" BSP	<b>S119032</b>	<b>101,69</b>

## Codo 90° macho-macho Métrico (60°) forja

90° Elbow Metric adaptor male-male (60°) forge

Adapteur coude 90° mâle Métrique x mâle Métrique (60°) forge

Adattatore a 90° maschio-maschio Metrico

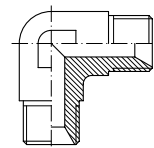

THREAD ROSCA		Part nº Referencia	€
M12x1.5	M12x1.5	<b>S86012</b>	<b>6,20</b>
M16x1.5	M16x1.5	<b>S86016</b>	<b>7,65</b>
M22x1.5	M22x1.5	<b>S86022</b>	<b>15,40</b>

## Codo 90° macho BSPT-hembra fija BSP forja

90° Elbow BSPT male-BSP fixed female forge

Adapteur coude 90° mâle gaz conique (BSPT) x femelle gaz conique (BSP) forge

Adattatore a 90° maschio BSPT - femmina fissa BSP (60°) forgiato

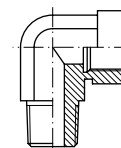

THREAD ROSCA		Part nº Referencia	€
M 1/8" BSPT	F 1/8" BSP	<b>S119402</b>	<b>3,44</b>
M 1/4" BSPT	F 1/4" BSP	<b>S119404</b>	<b>4,83</b>
M 3/8" BSPT	F 3/8" BSP	<b>S119406</b>	<b>4,73</b>
M 1/2" BSPT	F 1/2" BSP	<b>S119408</b>	<b>6,06</b>
M 3/4" BSPT	F 3/4" BSP	<b>S119412</b>	<b>11,04</b>
M 1" BSPT	F 1" BSP	<b>S119416</b>	<b>18,27</b>
M 1" 1/4 BSPT	F 1" 1/4 BSP	<b>S119420</b>	<b>54,07</b>
M 1" 1/2 BSPT	F 1" 1/2 BSP	<b>S119424</b>	<b>85,26</b>
M 2" BSPT	F 2" BSP	<b>S119432</b>	<b>143,49</b>

## Codo 90° macho BSP (60°) -macho BSPT forja

90° Elbow BSP male (60°)-BSPT male forge

Adapteur coude 90° mâle BSP x mâle gaz conique (BSPT) (60°) forge

Adattatore a 90° maschio BSP (60°) - maschio BSPT forgiato

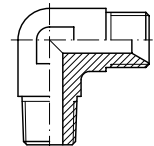

THREAD ROSCA		Part nº Referencia	€
1/8" BSP	1/8" BSPT	<b>S119202</b>	<b>2,08</b>
1/4" BSP	1/4" BSPT	<b>S119204</b>	<b>2,47</b>
3/8" BSP	3/8" BSPT	<b>S119206</b>	<b>3,55</b>
1/2" BSP	1/2" BSPT	<b>S119208</b>	<b>4,48</b>
3/4" BSP	3/4" BSPT	<b>S119212</b>	<b>7,02</b>
1" BSP	1" BSPT	<b>S119216</b>	<b>15,37</b>
1" 1/4 BSP	1" 1/4 BSPT	<b>S119220</b>	<b>43,06</b>
1" 1/2 BSP	1" 1/2 BSPT	<b>S119224</b>	<b>59,08</b>
2" BSP	2" BSPT	<b>S119232</b>	<b>130,18</b>

## Codo 90° macho-hembra giratoria BSP (60°) forja

90° Elbow BSP male-BSP swivel female forge

Adapteur coude 90° mâle BSP x femelle tournante BSP (60°) forge

Adattatore a 90° maschio-femmina girevole BSP (60°) forgiato

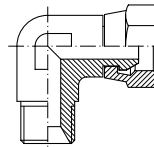

THREAD ROSCA		Part nº Referencia	€
1/8" BSP	1/8" BSP	<b>S119302</b>	<b>3,73</b>
1/4" BSP	1/4" BSP	<b>S119304</b>	<b>3,71</b>
3/8" BSP	3/8" BSP	<b>S119306</b>	<b>5,25</b>
1/2" BSP	1/2" BSP	<b>S119308</b>	<b>6,19</b>
3/4" BSP	3/4" BSP	<b>S119312</b>	<b>10,19</b>
1" BSP	1" BSP	<b>S119316</b>	<b>15,19</b>
1"1/4 BSP	1"1/4 BSP	<b>S119320</b>	<b>25,44</b>
1"1/2 BSP	1"1/2 BSP	<b>S119324</b>	<b>52,41</b>
2" BSP	2" BSP	<b>S119332</b>	<b>123,90</b>

## Codo 90° macho-macho BSPT forja

90° Elbow BSPT male-BSPT male forge

Adapteur coude 90° mâle gaz conique (BSPT) x mâle gaz conique (BSPT) forge

Adattatore a 90° maschio-maschio BSPT forgiato

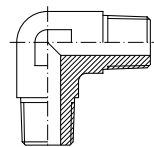

THREAD ROSCA		Part nº Referencia	€
1/4" BSPT	1/4" BSPT	<b>S119504</b>	<b>5,29</b>
3/8" BSPT	3/8" BSPT	<b>S119506</b>	<b>5,71</b>
1/2" BSPT	1/2" BSPT	<b>S119508</b>	<b>6,75</b>
3/4" BSPT	3/4" BSPT	<b>S119512</b>	<b>8,94</b>
1" BSPT	1" BSPT	<b>S119516</b>	<b>18,15</b>

## Codo 90° Macho BSP (60°) - Macho NPT (60°)

90° Elbow BSP adaptor male (60°) - NPT male (60°)

Adapteur coude 90° mâle BSP (60°) x mâle NPT (60°)

Adattatore a 90° maschio BSP (60°) - maschio NPT (60°)

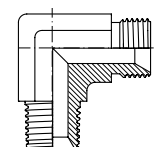

THREAD ROSCA		Part nº Referencia	€
1/4" BSP	1/4" NPT	<b>S11880404</b>	<b>4,15</b>
3/8" BSP	3/8" NPT	<b>S11880606</b>	<b>6,10</b>
1/2" BSP	1/2" NPT	<b>S11880808</b>	<b>8,05</b>
3/4" BSP	3/4" NPT	<b>S11881212</b>	<b>11,19</b>
1" BSP	1" NPT	<b>S11881616</b>	<b>19,41</b>

## Codo 90° macho BSPT-hembra giratoria BSP (60°) forja

90° Elbow BSPT male-BSP swivel female (60°) forge

Adapteur coude 90° mâle gaz conique (BSPT) x femelle tournante BSP (60°) forge

Adattatore a 90° maschio BSPT - femmina girevole BSP 60° forgiato

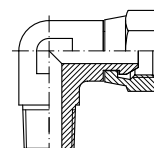

THREAD ROSCA		Part nº Referencia	€
M 1/4" BSPT	F 1/4" BSP	<b>S119904</b>	<b>7,57</b>
M 3/8" BSPT	F 3/8" BSP	<b>S119906</b>	<b>9,52</b>
M 1/2" BSPT	F 1/2" BSP	<b>S119908</b>	<b>12,40</b>
M 3/4" BSPT	F 3/4" BSP	<b>S119912</b>	<b>18,61</b>
M 1" BSPT	F 1" BSP	<b>S119916</b>	<b>30,18</b>

# Adaptadores BSP , BSPT y Métricos

Metric, BSP and BSPT Adaptors  
Adaptateurs BSP, BSPT et Métrique  
Adattatori BSP, BSPT e Metrico

## Codo 90° hembra giratoria-hembra giratoria BSP (60°) forja

90° Elbow BSP swivel female-BSP swivel female forge

Adapteur coude 90° femelle tournante BSP x femelle tournante BSP (60°) forge

Adattatore a 90° femmina girevole BSP (60°)-femmina girevole BSP (60°) forgiato

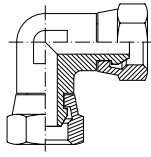

THREAD ROSCA		Part nº Referencia	€
1/8" BSP	1/8" BSP	<b>S118302</b>	<b>7,38</b>
1/4" BSP	1/4" BSP	<b>S118304</b>	<b>5,00</b>
3/8" BSP	3/8" BSP	<b>S118306</b>	<b>8,61</b>
1/2" BSP	1/2" BSP	<b>S118308</b>	<b>9,85</b>
3/4" BSP	3/4" BSP	<b>S118312</b>	<b>12,79</b>
1" BSP	1" BSP	<b>S118316</b>	<b>20,47</b>
1"1/4 BSP	1"1/4 BSP	<b>S118320</b>	<b>43,39</b>
1"1/2 BSP	1"1/2 BSP	<b>S118324</b>	<b>53,11</b>

## Codo 90° orientable macho-hembra giratoria BSP (60°) forja

90° Elbow male adjustable BSP-swivel female BSP forge

Adapteur coude 90° orientable mâle-femelle tournante (60°)

Adattatore a 90° orientabile maschio-femmina girevole BSP forgiato

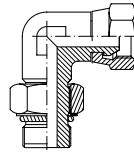

THREAD ROSCA		Part nº Referencia	€
1/4" BSP	1/4" BSP	<b>S119104</b>	<b>9,96</b>
3/8" BSP	3/8" BSP	<b>S119106</b>	<b>13,37</b>
1/2" BSP	1/2" BSP	<b>S119108</b>	<b>13,90</b>
3/4" BSP	3/4" BSP	<b>S119112</b>	<b>19,37</b>
1" BSP	1" BSP	<b>S119116</b>	<b>28,63</b>

## Codo 45° macho-hembra giratoria forja BSP 60° forja

45° Elbow BSP male-BSP swivel female forge

Adapteur coude 45° mâle-femelle tournante BSP forge

Adattatore a 45° maschio-femmina girevole BSP forgiato

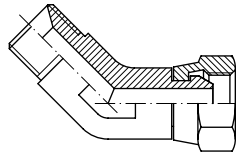

THREAD ROSCA		Part nº Referencia	€
1/8" BSP	1/8" BSP	<b>S118502</b>	<b>4,10</b>
1/4" BSP	1/4" BSP	<b>S118504</b>	<b>3,51</b>
3/8" BSP	3/8" BSP	<b>S118506</b>	<b>4,38</b>
1/2" BSP	1/2" BSP	<b>S118508</b>	<b>5,93</b>
3/4" BSP	3/4" BSP	<b>S118512</b>	<b>8,41</b>
1" BSP	1" BSP	<b>S118516</b>	<b>14,47</b>
1"1/4 BSP	1"1/4 BSP	<b>S118520</b>	<b>24,94</b>

## Codo 90° hembra fija-hembra fija BSP forja

90° Elbow BSP fixed female-BSP fixed female forge

Adapteur coude 90° femelle fixe gaz cyl forge

Adattatore a 90° maschio BSPT - femmina fissa BSP forgiato

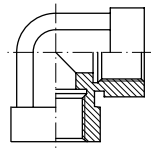

THREAD ROSCA		Part nº Referencia	€
1/8" BSP	1/8" BSP	<b>S119602</b>	<b>3,73</b>
1/4" BSP	1/4" BSP	<b>S119604</b>	<b>3,88</b>
3/8" BSP	3/8" BSP	<b>S119606</b>	<b>4,68</b>
1/2" BSP	1/2" BSP	<b>S119608</b>	<b>7,77</b>
3/4" BSP	3/4" BSP	<b>S119612</b>	<b>9,36</b>
1" BSP	1" BSP	<b>S119616</b>	<b>17,11</b>
1"1/4 BSP	1"1/4 BSP	<b>S119620</b>	<b>54,66</b>
1" 1/2 BSP	1" 1/2 BSP	<b>S119624</b>	<b>89,39</b>
2" BSP	2" BSP	<b>S119632</b>	<b>136,07</b>

## Codo 90° macho BSP (60°) -macho BSP regulable forja

90° Elbow BSP male-BSP male adjustable forge

Adapteur coude 90° mâle BSP x mâle gaz cyl orientable or + bae en forge

Adattatore a 90° maschio BSP 60° - maschio BSP regolabile forgiato

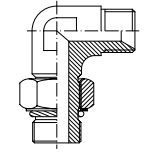

THREAD ROSCA		Part nº Referencia	€
1/8" BSP	1/8" BSP	<b>S11970202</b>	<b>3,54</b>
1/4" BSP	1/4" BSP	<b>S11970404</b>	<b>4,09</b>
3/8" BSP	1/4" BSP	<b>S11970604</b>	<b>5,66</b>
3/8" BSP	3/8" BSP	<b>S11970606</b>	<b>5,24</b>
1/2" BSP	3/8" BSP	<b>S11970806</b>	<b>6,11</b>
1/2" BSP	1/2" BSP	<b>S11970808</b>	<b>6,92</b>
3/4" BSP	1/2" BSP	<b>S11971208</b>	<b>11,80</b>
3/4" BSP	3/4" BSP	<b>S11971212</b>	<b>11,28</b>
1" BSP	3/4" BSP	<b>S11971612</b>	<b>20,09</b>
1" BSP	1" BSP	<b>S11971616</b>	<b>15,92</b>
1"1/4 BSP	1"1/4 BSP	<b>S11972020</b>	<b>31,25</b>
1" 1/2 BSP	1" 1/2 BSP	<b>S11972424</b>	<b>48,07</b>
2" BSP	2" BSP	<b>S11973232</b>	<b>132,50</b>

## Codo 90° Pasatabique Macho BSP (60°) - Macho BSP (60°)

90° Elbow bulkhead BSP adaptor male-male (60°)

Adapteur coude 90° passe cloison mâle BSP (60°) x mâle BSP (60°)

Adattatore a 90° pasaparete maschio-maschio BSP (60°)

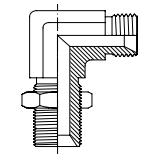

THREAD ROSCA		Part nº Referencia	€
1/4" BSP	1/4" BSP	<b>S11860404</b>	<b>6,61</b>
3/8" BSP	3/8" BSP	<b>S11860606</b>	<b>8,53</b>
1/2" BSP	1/2" BSP	<b>S11860808</b>	<b>11,32</b>
3/4" BSP	3/4" BSP	<b>S11861212</b>	<b>18,32</b>
1" BSP	1" BSP	<b>S11861616</b>	<b>28,48</b>

# Adaptadores BSP , BSPT y Métricos

Metric, BSP and BSPT Adaptors  
Adaptateurs BSP, BSPT et Métrique  
Adattatori BSP, BSPT e Metrico

## Codo 45° macho BSP (60°) - macho BSP regulable forja

45° Elbow BSP male-BSP male adjustable forge

Adapteur coude 45° mâle BSP x mâle gaz cyl orientable or + bae en forge

Adattatore a 45° maschio BSP 60° - maschio BSP regolabile forgiato

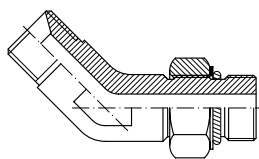

THREAD ROSCA		Part nº Referencia	€
M 1/8" BSP	MR 1/8" BSP	<b>S11980202</b>	<b>3,95</b>
M 1/4" BSP	MR 1/4" BSP	<b>S11980404</b>	<b>4,22</b>
M 3/8" BSP	MR 3/8" BSP	<b>S11980606</b>	<b>7,67</b>
M 1/2" BSP	MR 1/2" BSP	<b>S11980808</b>	<b>8,60</b>
M 3/4" BSP	MR 3/4" BSP	<b>S11981212</b>	<b>9,82</b>
M 1" BSP	MR 1" BSP	<b>S11981616</b>	<b>17,77</b>
M 1 1/4" BSP	MR 1 1/4" BSP	<b>S11982020</b>	<b>36,61</b>

## Codo 45° Macho BSP (60°) - Macho NPT (60°)

45° Elbow BSP adaptor male (60°) - NPT male (60°)

Adapteur coude 45° mâle BSP (60°) x mâle NPT (60°)

Adattatore a 45° maschio BSP (60°) - maschio NPT (60°)

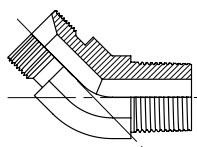

THREAD ROSCA		Part nº Referencia	€
1/4" BSP	1/4" NPT	<b>S11810404</b>	<b>4,15</b>
3/8" BSP	3/8" NPT	<b>S11810606</b>	<b>6,10</b>
1/2" BSP	1/2" NPT	<b>S11810808</b>	<b>8,05</b>
3/4" BSP	3/4" NPT	<b>S11811212</b>	<b>11,70</b>
1" BSP	1" NPT	<b>S11811616</b>	<b>20,09</b>

## Codo 45° Macho BSP (60°) - Macho BSPT

45° Elbow BSP adaptor male (60°) - BSPT male

Adapteur coude 45° mâle BSP (60°) x mâle BSPT

Adattatore a 45° maschio BSP (60°) - maschio BSPT

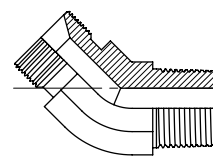

THREAD ROSCA		Part nº Referencia	€
1/4" BSP	1/4" BSPT	<b>S11870404</b>	<b>5,00</b>
3/8" BSP	3/8" BSPT	<b>S11870606</b>	<b>6,70</b>
1/2" BSP	1/2" BSPT	<b>S11870808</b>	<b>8,98</b>
3/4" BSP	3/4" BSPT	<b>S11871212</b>	<b>10,47</b>
1" BSP	1" BSPT	<b>S11871616</b>	<b>20,00</b>

## Codo 45° Regulable Macho BSP - H.G. BSP (60°)

45° Adjustable BSP elbow adaptor male (60°) - BSP female (60°)

Adapteur coude 45° réglable mâle BSP (60°) x femelle tournante BSP (60°)

Adattatore a 45° orientabile maschio BSP (60°) - femmina girevole BSP (60°)

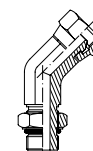

THREAD ROSCA		Part nº Referencia	€
1/4" BSP	1/4" BSP	<b>S11820404</b>	<b>7,54</b>
3/8" BSP	3/8" BSP	<b>S11820606</b>	<b>12,04</b>
1/2" BSP	1/2" BSP	<b>S11820808</b>	<b>15,17</b>
3/4" BSP	3/4" BSP	<b>S11821212</b>	<b>19,92</b>
1" BSP	1" BSP	<b>S11821616</b>	<b>32,80</b>

# Adaptadores BSP , BSPT y Métricos

Metric, BSP and BSPT Adaptors  
Adaptateurs BSP, BSPT et Métrique  
Adattatori BSP, BSPT e Metrico

## Te macho-macho-macho BSP forja

*Tee BSP Male (60°) forge*

Adaptateur Té mâle BSP-mâle BSP-mâle BSP (60°) forge

Adattatore a T maschio BSP (60°) forgiato

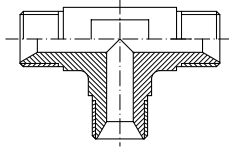

THREAD ROSCA			Part n° Referencia	€
1/8" BSP	1/8" BSP	1/8" BSP	<b>S122002</b>	<b>3,46</b>
1/4" BSP	1/4" BSP	1/4" BSP	<b>S122004</b>	<b>3,58</b>
3/8" BSP	3/8" BSP	3/8" BSP	<b>S122006</b>	<b>4,34</b>
1/2" BSP	1/2" BSP	1/2" BSP	<b>S122008</b>	<b>5,94</b>
3/4" BSP	3/4" BSP	3/4" BSP	<b>S122012</b>	<b>8,44</b>
1" BSP	1" BSP	1" BSP	<b>S122016</b>	<b>15,48</b>
1"1/4 BSP	1"1/4 BSP	1"1/4 BSP	<b>S122020</b>	<b>43,98</b>
1"1/2 BSP	1"1/2 BSP	1"1/2 BSP	<b>S122024</b>	<b>75,86</b>
2" BSP	2" BSP	2" BSP	<b>S122032</b>	<b>156,07</b>

## Te macho-macho-hembra giratoria BSP (60°) forja

*Barrel tee BSP Male-male-swivel female (60°) forge*

Adaptateur Té mâle BSP-mâle BSP-femelle tournante BSP (60°) forge

Adattatore a T maschio-maschio-femmine girevole BSP forgiato

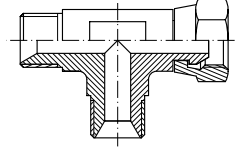

THREAD ROSCA			Part n° Referencia	€
1/8" BSP	1/8" BSP	1/8" BSP	<b>S122302</b>	<b>4,01</b>
1/4" BSP	1/4" BSP	1/4" BSP	<b>S122304</b>	<b>4,64</b>
3/8" BSP	3/8" BSP	3/8" BSP	<b>S122306</b>	<b>5,93</b>
1/2" BSP	1/2" BSP	1/2" BSP	<b>S122308</b>	<b>7,72</b>
3/4" BSP	3/4" BSP	3/4" BSP	<b>S122312</b>	<b>13,04</b>
1" BSP	1" BSP	1" BSP	<b>S122316</b>	<b>19,74</b>
1"1/4 BSP	1"1/4 BSP	1"1/4 BSP	<b>S122320</b>	<b>32,69</b>
1" 1/2 BSP	1" 1/2 BSP	1" 1/2 BSP	<b>S122324</b>	<b>82,65</b>
2" BSP	2" BSP	2" BSP	<b>S122332</b>	<b>185,69</b>

## Te macho-hembra giratoria-macho BSP (60°) forja

*Brunch tee BSP Male-swivel female-male (60°) forge*

Adaptateur Té mâle BSP-femelle tournante BSP-mâle BSP (60°) forge

Adattatore a T maschio-femmina girevole-maschio BSP forgiato

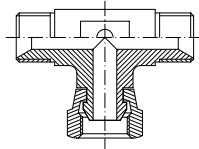

THREAD ROSCA			Part n° Referencia	€
1/8" BSP	1/8" BSP	1/8" BSP	<b>S122402</b>	<b>4,34</b>
1/4" BSP	1/4" BSP	1/4" BSP	<b>S122404</b>	<b>4,12</b>
3/8" BSP	3/8" BSP	3/8" BSP	<b>S122406</b>	<b>5,54</b>
1/2" BSP	1/2" BSP	1/2" BSP	<b>S122408</b>	<b>7,72</b>
3/4" BSP	3/4" BSP	3/4" BSP	<b>S122412</b>	<b>12,23</b>
1" BSP	1" BSP	1" BSP	<b>S122416</b>	<b>19,74</b>
1"1/4 BSP	1"1/4 BSP	1"1/4 BSP	<b>S122420</b>	<b>32,69</b>
1" 1/2 BSP	1" 1/2 BSP	1" 1/2 BSP	<b>S122424</b>	<b>90,35</b>
2" BSP	2" BSP	2" BSP	<b>S122432</b>	<b>202,99</b>

## Te macho-macho-macho Métrica (60°)

*Tee Metric male (60°)*

Adaptateur Té égal mâle-mâle-mâle Métrique (60°)

Adattatore a T maschio-maschio-maschio Metrico

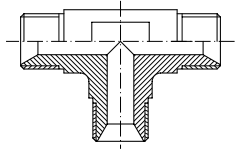

THREAD ROSCA			Part n° Referencia	€
M16x1.5	M16x1.5	M16x1.5	<b>S86516</b>	<b>10,05</b>
M18x1.5	M18x1.5	M18x1.5	<b>S86518</b>	<b>10,85</b>
M20x1.5	M20x1.5	M20x1.5	<b>S86520</b>	<b>13,13</b>
M22x1.5	M22x1.5	M22x1.5	<b>S86522</b>	<b>13,13</b>
M26x1.5	M26x1.5	M26x1.5	<b>S86526</b>	<b>21,44</b>
M30x1.5	M30x1.5	M30x1.5	<b>S86530</b>	<b>28,44</b>

## Te hembras giratorias BSP (60°) forja

*Tee BSP Swivel female (60°) forge*

Adaptateur Té femelle tournante BSP (60°) forge

Adattatore a T femmina girevole BSP forgiato

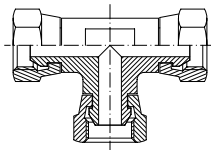

THREAD ROSCA			Part n° Referencia	€
1/8" BSP	1/8" BSP	1/8" BSP	<b>S122502</b>	<b>8,99</b>
1/4" BSP	1/4" BSP	1/4" BSP	<b>S122504</b>	<b>6,91</b>
3/8" BSP	3/8" BSP	3/8" BSP	<b>S122506</b>	<b>8,82</b>
1/2" BSP	1/2" BSP	1/2" BSP	<b>S122508</b>	<b>11,33</b>
3/4" BSP	3/4" BSP	3/4" BSP	<b>S122512</b>	<b>20,14</b>
1" BSP	1" BSP	1" BSP	<b>S122516</b>	<b>32,46</b>
1" 1/4 BSP	1" 1/4 BSP	1" 1/4 BSP	<b>S122520</b>	<b>67,84</b>

## Te hembras fijas BSP forja

*Tee BSP fixed female forge*

Adaptateur Té femelle fixe gaz (BSP) forge

Adattatore a T femmina fissa BSP

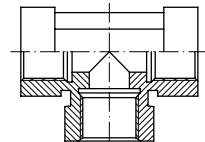

THREAD ROSCA			Part n° Referencia	€
1/8" BSP	1/8" BSP	1/8" BSP	<b>S122602</b>	<b>4,37</b>
1/4" BSP	1/4" BSP	1/4" BSP	<b>S122604</b>	<b>4,76</b>
3/8" BSP	3/8" BSP	3/8" BSP	<b>S122606</b>	<b>6,75</b>
1/2" BSP	1/2" BSP	1/2" BSP	<b>S122608</b>	<b>9,20</b>
3/4" BSP	3/4" BSP	3/4" BSP	<b>S122612</b>	<b>14,30</b>
1" BSP	1" BSP	1" BSP	<b>S122616</b>	<b>26,01</b>
1"1/4 BSP	1"1/4 BSP	1"1/4 BSP	<b>S122620</b>	<b>90,56</b>
1" 1/2 BSP	1" 1/2 BSP	1" 1/2 BSP	<b>S122624</b>	<b>130,10</b>
2" BSP	2" BSP	2" BSP	<b>S122632</b>	<b>236,09</b>

# Adaptadores BSP , BSPT y Métricos

Metric, BSP and BSPT Adaptors  
Adaptateurs BSP, BSPT et Métrique  
Adattatori BSP, BSPT e Metrico

## Te macho-macho-macho regulable BSP forja

Barrel tee BSP male-male-male adjustable forge

Adaptateur Té égal mâle (60°)-mâle (60°)-mâle orientable BSP forge

Adattatore a T maschio-maschio-maschio orientabile BSP

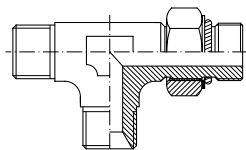

THREAD ROSCA			Part nº Referencia	€
1/4" BSP	1/4" BSP	1/4" BSP	<b>S12290404</b>	<b>5,95</b>
3/8" BSP	3/8" BSP	3/8" BSP	<b>S12290606</b>	<b>9,23</b>
1/2" BSP	3/8" BSP	1/2" BSP	<b>S12290806</b>	<b>15,76</b>
1/2" BSP	1/2" BSP	1/2" BSP	<b>S12290808</b>	<b>15,43</b>
3/4" BSP	1/2" BSP	3/4" BSP	<b>S12291208</b>	<b>24,66</b>
3/4" BSP	3/4" BSP	3/4" BSP	<b>S12291212</b>	<b>36,45</b>
1" BSP	3/4" BSP	1" BSP	<b>S12291612</b>	<b>41,36</b>
1" BSP	1" BSP	1" BSP	<b>S12291616</b>	<b>53,58</b>
1"1/4 BSP	1"1/4 BSP	1"1/4 BSP	<b>S12292020</b>	<b>54,58</b>

## Te macho-macho regulable-macho BSP forja

Brunch tee BSP male-male adjustable-male forge

Adaptateur Té égal mâle (60°)-mâle orientable-mâle (60°) BSP forge

Adattatore a T maschio-maschio orientabile-maschio forgiato

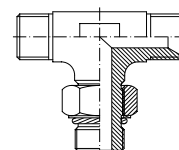

THREAD ROSCA			Part nº Referencia	€
1/4" BSP	1/4" BSP	1/4" BSP	<b>S12280404</b>	<b>5,95</b>
3/8" BSP	1/4" BSP	3/8" BSP	<b>S12280604</b>	<b>12,04</b>
3/8" BSP	3/8" BSP	3/8" BSP	<b>S12280606</b>	<b>12,72</b>
1/2" BSP	3/8" BSP	1/2" BSP	<b>S12280806</b>	<b>15,76</b>
1/2" BSP	1/2" BSP	1/2" BSP	<b>S12280808</b>	<b>15,69</b>
3/4" BSP	1/2" BSP	3/4" BSP	<b>S12281208</b>	<b>24,66</b>
3/4" BSP	3/4" BSP	3/4" BSP	<b>S12281212</b>	<b>25,26</b>
1" BSP	3/4" BSP	1" BSP	<b>S12281612</b>	<b>48,14</b>
1" BSP	1" BSP	1" BSP	<b>S12281616</b>	<b>51,33</b>
1"1/4 BSP	1" BSP	1"1/4 BSP	<b>S12282016</b>	<b>54,24</b>
1"1/4 BSP	1"1/4 BSP	1"1/4 BSP	<b>S12282020</b>	<b>60,35</b>

## Cruz hembra fija BSP

Cross fixed female BSP

Cross BSP femelle fixe

BSP femmina fisso a croce

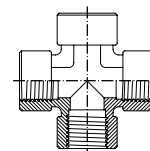

THREAD ROSCA	Part nº Referencia	€
1/8" BSP	<b>S122702</b>	<b>8,29</b>
1/4" BSP	<b>S122704</b>	<b>9,32</b>
3/8" BSP	<b>S122706</b>	<b>10,36</b>
1/2" BSP	<b>S122708</b>	<b>12,43</b>
3/4" BSP	<b>S122712</b>	<b>14,50</b>
1" BSP	<b>S122716</b>	<b>20,72</b>

# Adaptadores BSP , BSPT y Métricos

Metric, BSP and BSPT Adaptors  
Adaptateurs BSP, BSPT et Métrique  
Adattatori BSP, BSPT e Metrico

## Codo cuadrado 90° reductor macho-macho BSP (60°)

90° reducer elbow male-male BSP (60°) (square)

Adapteur carré coude 90° reducteur mâle BSP - mâle BSP (60°) en bloque

Adattatore a 90° maschio-maschio quadrato BSP (60°)

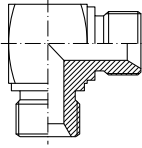

THREAD ROSCA		Part n° Referencia	€
1/8" BSP	1/4" BSP	<b>A11920204</b>	<b>5,75</b>
1/4" BSP	3/8" BSP	<b>A11920406</b>	<b>7,08</b>
3/8" BSP	1/2" BSP	<b>A11920608</b>	<b>10,40</b>
1/2" BSP	3/4" BSP	<b>A11920812</b>	<b>14,22</b>
3/4" BSP	1" BSP	<b>A11921216</b>	<b>33,31</b>

## Codo cuadrado 90° macho BSP

90° Elbow BSP male (square)

Adapteur carré Coude 90° mâle BSP

Adattatore a 90° maschio-maschio quadrato BSP (60°)

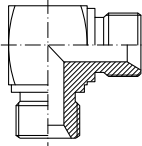

THREAD ROSCA		Part n° Referencia	€
1/4" BSP	1/4" BSP	<b>A21900400</b>	<b>3,79</b>
3/8" BSP	3/8" BSP	<b>A21900600</b>	<b>4,19</b>
1/2" BSP	1/2" BSP	<b>A21900800</b>	<b>6,05</b>
3/4" BSP	3/4" BSP	<b>A21901200</b>	<b>8,77</b>
1" BSP	1" BSP	<b>A21901600</b>	<b>16,95</b>

## Codo cuadrado 90° macho-hembra giratoria

90° Elbow BSP male-BSP swivel female (square)

Adapteur carré Coude 90° mâle BSP - femelle BSP

Adattatore a 90° maschio-femmina girevole quadrato BSP (60°)

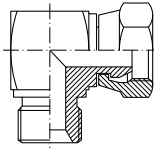

THREAD ROSCA		Part n° Referencia	€
1/4" BSP	1/4" BSP	<b>A21930400</b>	<b>4,67</b>
3/8" BSP	3/8" BSP	<b>A21930600</b>	<b>5,18</b>
1/2" BSP	1/2" BSP	<b>A21930800</b>	<b>7,49</b>
3/4" BSP	3/4" BSP	<b>A21931200</b>	<b>10,37</b>
1" BSP	1" BSP	<b>A21931600</b>	<b>30,03</b>

## Te cuadrado macho-macho-macho

Tee BSP male (square)

Adapteur carré Té mâle BSP-mâle BSP-mâle BSP

Adattatore a T maschio quadrato BSP 60°

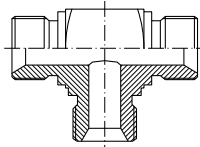

THREAD ROSCA			Part n° Referencia	€
1/4" BSP	1/4" BSP	1/4" BSP	<b>A22200400</b>	<b>4,85</b>
3/8" BSP	3/8" BSP	3/8" BSP	<b>A22200600</b>	<b>5,66</b>
1/2" BSP	1/2" BSP	1/2" BSP	<b>A22200800</b>	<b>8,44</b>
3/4" BSP	3/4" BSP	3/4" BSP	<b>A22201200</b>	<b>12,76</b>
1" BSP	1" BSP	1" BSP	<b>A22201600</b>	<b>24,29</b>

## Te cuadrado macho-hembra giratoria-macho

Branch tee BSP male-swivel female-male (square)

Adapteur carré Té mâle BSP-femelle tournante BSP-mâle BSP

Adattatore a T maschio-femmina girevole-maschio quadrato BSP (60°)

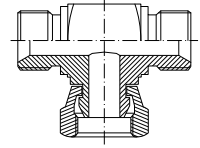

THREAD ROSCA			Part n° Referencia	€
1/4" BSP	1/4" BSP	1/4" BSP	<b>A22240400</b>	<b>5,05</b>
3/8" BSP	3/8" BSP	3/8" BSP	<b>A22240600</b>	<b>6,52</b>
1/2" BSP	1/2" BSP	1/2" BSP	<b>A22240800</b>	<b>9,17</b>
3/4" BSP	3/4" BSP	3/4" BSP	<b>A22241200</b>	<b>12,96</b>
1" BSP	1" BSP	1" BSP	<b>A22241600</b>	<b>24,80</b>

## Te cuadrado macho-macho-hembra giratoria

Barrel tee BSP male-male-swivel female (square)

Adapteur carré Té mâle BSP-mâle BSP-femelle tournante BSP

Adattatore a T maschio-maschio-femmina girevole quadrato BSP

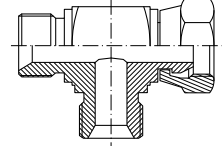

THREAD ROSCA			Part n° Referencia	€
1/4" BSP	1/4" BSP	1/4" BSP	<b>A22220400</b>	<b>5,25</b>
3/8" BSP	3/8" BSP	3/8" BSP	<b>A22220600</b>	<b>6,70</b>
1/2" BSP	1/2" BSP	1/2" BSP	<b>A22220800</b>	<b>8,71</b>
3/4" BSP	3/4" BSP	3/4" BSP	<b>A22221200</b>	<b>18,42</b>
1" BSP	1" BSP	1" BSP	<b>A22221600</b>	<b>23,58</b>

## Cruz cuadrada macho BSP

Cross BSP male (square)

Adapteur carré Croix égale mâle BSP

Groce maschio BSP 60°

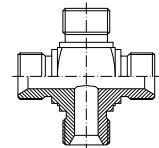

THREAD ROSCA		Part n° Referencia	€
1/4" BSP		<b>A22230400</b>	<b>7,24</b>
3/8" BSP		<b>A22230600</b>	<b>6,78</b>
1/2" BSP		<b>A22230800</b>	<b>12,76</b>
3/4" BSP		<b>A22231200</b>	<b>22,39</b>
1" BSP		<b>A22231600</b>	<b>22,39</b>

# Adaptadores BSP , BSPT y Métricos

Metric, BSP and BSPT Adaptors  
Adaptateurs BSP, BSPT et Métrique  
Adattatori BSP, BSPT e Metrico

Adaptors

Quick-release couplings

Ball valves

Diverters

Swivel fittings

Multi-way couplings

Protections

## Juntas Metal Buna BSP Autocentrantes

BSP Bonded Seal

Bague BS BSPz

Rondelle Bonded BSP

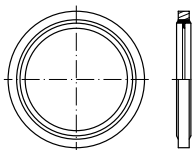

THREAD ROSCA	UNITS PER BAG CANTIDAD / BOLSA	Part nº Referencia	€
1/8" BSP	100	T21002	0,19
1/4" BSP	100	T21004	0,20
3/8" BSP	100	T21006	0,25
1/2" BSP	100	T21008	0,28
5/8" BSP	100	T21010	0,59
3/4" BSP	100	T21012	0,39
1" BSP	50	T21016	0,67
1" 1/4 BSP	25	T21020	1,01
1" 1/2 BSP	25	T21024	1,23
2" BSP	25	T21032	1,85
2" 1/2 BSP	25	T21040	20,79

Se venden en bolsas, precios por unidad. / Sold in bags, prices per unit / Vendu dans des sacs, prix par unité / Venduti in sacchetti, prezzo per unità

## Juntas Metal Buna Métricas Autocentrantes

Metric Bonded Seal

Bague BS Métrique

Rondelle Bonded Metriche

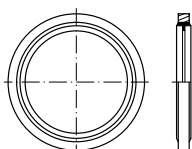

THREAD ROSCA	UNITS PER BAG CANTIDAD / BOLSA	Part nº Referencia	€
M6X1	100	T32006	0,28
M8x1	100	T32008	0,24
M10x1	100	T32010	0,24
M12x1.5	100	T32012	0,26
M14x1.5	100	T32014	0,27
M16x1.5	100	T32016	0,29
M18x1.5	100	T32018	0,33
M20x1.5	100	T32020	0,34
M22x1.5	100	T32022	0,37
M24x1.5	100	T32024	0,43
M26x1.5	100	T32026	0,62
M27X1,5	100	T32027	1,12
M30x2	50	T32030	0,68
M36x2	25	T32036	1,28
M42x2	25	T32042	2,64
M48X2	25	T32048	3,20

Se venden en bolsas, precios por unidad. / Sold in bags, prices per unit / Vendu dans des sacs, prix par unité / Venduti in sacchetti, prezzo per unità

## Arandelas Aluminio BSP

BSP Aluminium Collar Plate

Rondelle BSP Aluminium

Rondella in Alluminio BSP

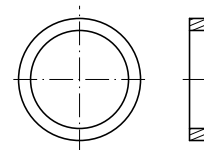

THREAD ROSCA	Ø OUTER Ø EXT.	Ø INNER Ø INT.	Part nº Referencia	€
1/8"	14	10	A133202	0,10
1/4"	19	13	A133204	0,13
3/8"	22	17	A133206	0,17
1/2"	27	21	A133208	0,27
3/4"	33	27	A133212	0,35
1"	41	33	A133216	0,51
1" 1/4	50	42	A133220	1,45
1" 1/2	60	48	A133224	0,93

## Arandelas plana Cobre recocido BSP

BSP Annealed Copper flat Plate

Rondelle plane BSP Cuivre recuit

Rondella in Rame BSP

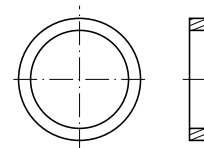

THREAD ROSCA	Ø OUTER Ø EXT.	Ø INNER Ø INT.	Part nº Referencia	€
1/8"	14	10	A133002	0,22
1/4"	19	13	A133004	0,34
3/8"	22	17	A133006	0,34
1/2"	27	21	A133008	0,55
3/4"	33	27	A133012	0,98
1"	41	33	A133016	1,09
1" 1/4	50	42	A133020	1,52
1" 1/2	56	48	A133024	2,89
2"	72	60	A133032	4,79

## Arandelas plana Acero BSP

BSP Steel flat Plate

Bague plate Acier BSP

Rondelle in Acciaio BSP

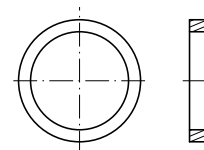

THREAD ROSCA	Ø OUTER Ø EXT.	Ø INNER Ø INT.	Part nº Referencia	€
1/8"	15	12.2	A13330200000	1,16
1/4"	19.5	16.15	A13330400000	1,14
3/8"	23.5	19.5	A13330600000	1,07
1/2"	28.5	23.3	A13330800000	1,17
3/4"	34.5	28.6	A13331200000	1,23
1"	43.5	36.6	A13331600000	1,35
1" 1/4	52.5	44.9	A13332000000	1,50

# Adaptadores NPT

NPT Adaptors  
Adaptateurs NPT  
Adattatori NPT

## Adaptor macho - macho NPT

Adaptor male NPT - male NPT

Adaptateur mâle NPT - mâle NPT

Nipples di congiunzione NPT

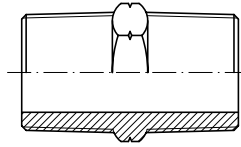

THREAD ROSCA		Part n° Referencia	€
1/8" NPT	1/8" NPT	<b>A10150202</b>	<b>1,06</b>
1/4" NPT	1/4" NPT	<b>A10150404</b>	<b>1,58</b>
3/8" NPT	3/8" NPT	<b>A10150606</b>	<b>2,00</b>
1/2" NPT	1/2" NPT	<b>A10150808</b>	<b>2,16</b>
3/4" NPT	3/4" NPT	<b>A10151212</b>	<b>4,12</b>
1" NPT	1" NPT	<b>A10151616</b>	<b>6,18</b>
1" 1/4 NPT	1" 1/4 NPT	<b>A10152020</b>	<b>11,11</b>
1" 1/2 NPT	1" 1/2 NPT	<b>A10152424</b>	<b>16,03</b>
2" NPT	2" NPT	<b>A10153232</b>	<b>35,74</b>

## Reductor macho - macho NPT

Reducer male NPT - male NPT

Réducteur mâle NPT - mâle NPT

Nipples di riduzione maschio - maschio NPT

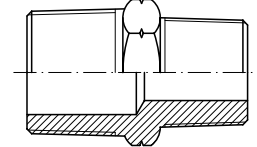

THREAD ROSCA		Part n° Referencia	€
1/4" NPT	1/8" NPT	<b>A10150402</b>	<b>1,07</b>
3/8" NPT	1/8" NPT	<b>A10150602</b>	<b>1,17</b>
3/8" NPT	1/4" NPT	<b>A10150604</b>	<b>1,80</b>
1/2" NPT	1/4" NPT	<b>A10150804</b>	<b>2,23</b>
1/2" NPT	3/8" NPT	<b>A10150806</b>	<b>2,10</b>
3/4" NPT	1/4" NPT	<b>A10151204</b>	<b>3,53</b>
3/4" NPT	3/8" NPT	<b>A10151206</b>	<b>3,53</b>
3/4" NPT	1/2" NPT	<b>A10151208</b>	<b>3,49</b>
1" NPT	1/2" NPT	<b>A10151608</b>	<b>6,67</b>
1" NPT	3/4" NPT	<b>A10151612</b>	<b>6,76</b>
1" 1/4 NPT	1" NPT	<b>A10152016</b>	<b>12,03</b>
1" 1/2 NPT	1" 1/4 NPT	<b>A10152420</b>	<b>16,03</b>
2" NPT	1" 1/2 NPT	<b>A10153224</b>	<b>35,74</b>

## Adaptador Macho NPT (60°) - H.G. NPSM (60°)

Adaptor male NPT (60°) - swivel female NPSM (60°)

Adaptateur mâle NPT (60°) - femelle tournante NPSM (60°)

Nipples di congiunzione maschio NPT (60°) - femmina girevole NPSM (60°)

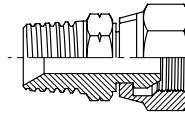

THREAD ROSCA		Part n° Referencia	€
M 1/4" NPT	F 1/4" NPSM	<b>N11700404</b>	<b>3,90</b>
M 3/8" NPT	F 3/8" NPSM	<b>N11700606</b>	<b>5,00</b>
M 1/2" NPT	F 1/2" NPSM	<b>N11700808</b>	<b>6,61</b>
M 3/4" NPT	F 3/4" NPSM	<b>N11701212</b>	<b>7,57</b>
M 1" NPT	F 1" NPSM	<b>N11701616</b>	<b>15,51</b>
M 1" 1/4 NPT	F 1" 1/4 NPSM	<b>N11702020</b>	<b>23,56</b>

## Adaptador Macho NPT (60°) - Hembra Fija NPT

Adaptor male NPT (60°) - fixed female NPT

Adaptateur mâle NPT (60°) - femelle fixe NPT

Nipples di congiunzione maschio NPT (60°) - femmina fissa NPT

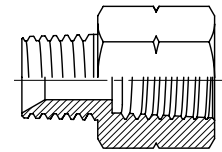

THREAD ROSCA		Part n° Referencia	€
M 1/4" NPT	F 1/4" NPT	<b>N10600404</b>	<b>3,09</b>
M 1/4" NPT	F 3/8" NPT	<b>N10600406</b>	<b>3,78</b>
M 3/8" NPT	F 1/4" NPT	<b>N10600604</b>	<b>2,64</b>
M 3/8" NPT	F 3/8" NPT	<b>N10600606</b>	<b>3,90</b>
M 3/8" NPT	F 1/2" NPT	<b>N10600608</b>	<b>6,19</b>
M 1/2" NPT	F 3/8" NPT	<b>N10600806</b>	<b>4,66</b>
M 1/2" NPT	F 1/2" NPT	<b>N10600808</b>	<b>6,36</b>
M 1/2" NPT	F 3/4" NPT	<b>N10600812</b>	<b>8,73</b>
M 3/4" NPT	F 3/4" NPT	<b>N10601212</b>	<b>9,07</b>
M 1" NPT	F 1" NPT	<b>N10601616</b>	<b>14,15</b>

# Adaptadores NPT

NPT Adaptors  
Adaptateurs NPT  
Adattatori NPT

## Adaptador Hembra Fija NPT - Hembra Fija NPT

NPT adaptor fixed female - fixed female NPT

Adaptateur femelle fixe NPT - femelle fixe NPT

Adattatore femmina fissa NPT - femmina fissa NPT

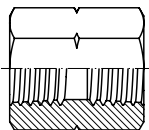

THREAD ROSCA	Part nº Referencia	€
1/4" NPT	<b>N103100404</b>	<b>2,40</b>
3/8" NPT	<b>N103100606</b>	<b>3,06</b>
1/2" NPT	<b>N103100808</b>	<b>5,21</b>
3/4" NPT	<b>N103101212</b>	<b>7,41</b>
1" NPT	<b>N103101616</b>	<b>11,21</b>

## Tapón HF NPT

NPT fixed female cap

Bouchon femelle fixe NPT

Tappo femmina fissa NPT

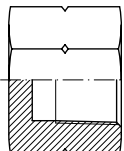

THREAD ROSCA	Part nº Referencia	€
1/8" NPT	<b>N107202</b>	<b>0,80</b>
1/4" NPT	<b>N107204</b>	<b>1,00</b>
3/8" NPT	<b>N107206</b>	<b>1,54</b>
1/2" NPT	<b>N107208</b>	<b>2,19</b>
3/4" NPT	<b>N107212</b>	<b>3,18</b>
1" NPT	<b>N107216</b>	<b>5,07</b>

## Tapón Allen NPT

NPT Allen plug

Bouchon Allen NPT

Tappo conico NPT

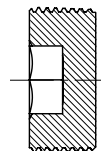

THREAD ROSCA	Part nº Referencia	€
1/4" NPT	<b>N107104</b>	<b>1,36</b>
3/8" NPT	<b>N107106</b>	<b>1,94</b>
1/2" NPT	<b>N107108</b>	<b>2,58</b>
3/4" NPT	<b>N107112</b>	<b>3,48</b>
1" NPT	<b>N107116</b>	<b>5,85</b>

## Tapón macho NPT

NPT male plug

Bouchon mâle NPT

Tappo maschio NPT

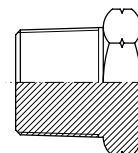

THREAD ROSCA	Part nº Referencia	€
1/4" NPT	<b>N107004</b>	<b>1,04</b>
3/8" NPT	<b>N107006</b>	<b>1,23</b>
1/2" NPT	<b>N107008</b>	<b>1,88</b>
3/4" NPT	<b>N107012</b>	<b>3,62</b>
1" NPT	<b>N107016</b>	<b>5,56</b>

Quick-release couplings

Ball valves

Diverter

Swivel fittings

Multi-way couplings

Protections

# Adaptadores NPT

NPT Adaptors  
Adapteurs NPT  
Adattatori NPT

## Codo 45 Macho NPT (60°) - Macho NPT (60°)

45° elbow male NPT 60 - male NPT 60

Coude 45° mâle NPT 60° - mâle NPT 60°

Adattatore a 45° maschio 60 - maschio NPT 60

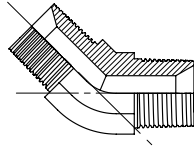

THREAD ROSCA	Part n° Referencia	€
1/4" NPT	<b>N11980404</b>	<b>3,81</b>
3/8" NPT	<b>N11980606</b>	<b>5,17</b>
1/2" NPT	<b>N11980808</b>	<b>7,37</b>
3/4" NPT	<b>N11981212</b>	<b>11,27</b>
1" NPT	<b>N11981616</b>	<b>17,88</b>

## Codo 90° HF-HF NPT

90° elbow fixed female NPT - fixed female NPT

Coude 90° femelle fixe NPT - femelle fixe NPT

Adattatore a 90° femmina fissa - femmina fissa NPSM

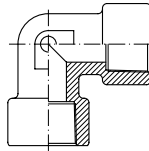

THREAD ROSCA	Part n° Referencia	€
1/8" NPT	<b>N119602</b>	<b>2,53</b>
1/4" NPT	<b>N119604</b>	<b>3,92</b>
3/8" NPT	<b>N119606</b>	<b>5,09</b>
1/2" NPT	<b>N119608</b>	<b>7,98</b>
3/4" NPT	<b>N119612</b>	<b>13,26</b>
1" NPT	<b>N119616</b>	<b>19,70</b>
1 1/4" NPT	<b>N119620</b>	<b>29,17</b>
1 1/2" NPT	<b>N119624</b>	<b>53,56</b>
2" NPT	<b>N119632</b>	<b>95,35</b>

## Codo 90° M-M NPT

90° elbow male NPT - male NPT

Coude 90° mâle NPT - mâle NPT

Adattatore a 90° maschio - maschio NPT

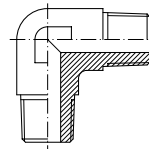

THREAD ROSCA	Part n° Referencia	€
1/8" NPT	<b>N119002</b>	<b>2,47</b>
1/4" NPT	<b>N119004</b>	<b>3,08</b>
3/8" NPT	<b>N119006</b>	<b>4,02</b>
1/2" NPT	<b>N119008</b>	<b>5,71</b>
3/4" NPT	<b>N119012</b>	<b>9,04</b>
1" NPT	<b>N119016</b>	<b>14,75</b>
1 1/4" NPT	<b>N119020</b>	<b>25,24</b>
1 1/2" NPT	<b>N119024</b>	<b>35,65</b>
2" NPT	<b>N119032</b>	<b>73,86</b>

## Codo 90 Macho NPT (60°) - H.G. NPSM (60°)

90° elbow male NPT 60 - swivel female NPSM 60

Coude 90° mâle NPT 60° - femelle tournante NPSM 60°

Adattatore a 90° maschio NPT 60 - femmina girevole NPSM 60

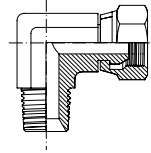

THREAD ROSCA		Part n° Referencia	€
M 1/4" NPT	F 1/4" NPSM	<b>N11930404</b>	<b>5,34</b>
M 3/8" NPT	F 3/8" NPSM	<b>N11930606</b>	<b>7,04</b>
M 1/2" NPT	F 1/2" NPSM	<b>N11930808</b>	<b>8,21</b>
M 3/4" NPT	F 3/4" NPSM	<b>N11931212</b>	<b>13,31</b>
M 1" NPT	F 1" NPSM	<b>N11931616</b>	<b>21,02</b>
M 1 1/4" NPT	F 1 1/4" NPSM	<b>N11932020</b>	<b>35,26</b>

## Codo 45 Hembra Fija NPT - Hembra Fija NPT

45° elbow fixed female NPT - fixed female NPT

Coude 45° femelle fixe NPT - femelle fixe NPT

Adattatore a 45° femmina fissa 60 - femmina fissa NPT 60

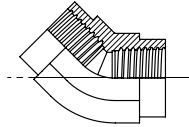

THREAD ROSCA	Part n° Referencia	€
1/4" NPT	<b>N11960404</b>	<b>5,85</b>
3/8" NPT	<b>N11960606</b>	<b>7,04</b>
1/2" NPT	<b>N11960808</b>	<b>9,49</b>
3/4" NPT	<b>N11961212</b>	<b>13,99</b>
1" NPT	<b>N11961616</b>	<b>23,39</b>

## Codo 45 Macho NPT (60°) - H.G. NPSM (60°)

45° elbow male NPT 60° - swivel female NPSM 60°

Coude 45° mâle NPT 60° - swivel female NPSM 60°

Adattatore a 45° maschio NPT 60 - femmina girevole NPSM 60

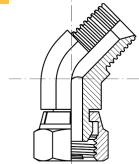

THREAD ROSCA		Part n° Referencia	€
M 1/4" NPT	F 1/4" NPSM	<b>N13930404</b>	<b>5,58</b>
M 3/8" NPT	F 3/8" NPSM	<b>N13930606</b>	<b>7,35</b>
M 1/2" NPT	F 1/2" NPSM	<b>N13930808</b>	<b>9,39</b>
M 3/4" NPT	F 3/4" NPSM	<b>N13931212</b>	<b>13,90</b>
M 1" NPT	F 1" NPSM	<b>N13931616</b>	<b>21,96</b>
M 1 1/4" NPT	F 1 1/4" NPSM	<b>N13932020</b>	<b>38,87</b>

# Adaptadores NPT

NPT Adaptors  
Adapteurs NPT  
Adattatori NPT

## T M-M-M NPT

NPT male tee

Té mâle NPT

Adattatore a T maschio-maschio-maschio NPT

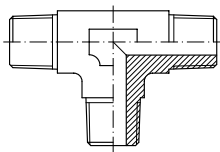

THREAD ROSCA	Part n° Referencia	€
1/8" NPT	<b>N122002</b>	<b>3,80</b>
1/4" NPT	<b>N122004</b>	<b>4,01</b>
3/8" NPT	<b>N122006</b>	<b>5,06</b>
1/2" NPT	<b>N122008</b>	<b>9,89</b>
3/4" NPT	<b>N122012</b>	<b>16,36</b>
1" NPT	<b>N122016</b>	<b>22,09</b>
1" 1/4 NPT	<b>N122020</b>	<b>52,29</b>
3/4" NPT	<b>N122024</b>	<b>84,59</b>
2" NPT	<b>N122032</b>	<b>188,58</b>

## T HF-HF-HF NPT

NPT fixed female tee

Té femelle fixe NPT

Adattatore a T femmina fissa-femmina fissa-femmina fissa NPT

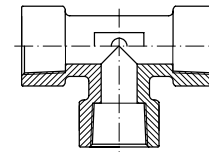

THREAD ROSCA	Part n° Referencia	€
1/8" NPT	<b>N122602</b>	<b>4,44</b>
1/4" NPT	<b>N122604</b>	<b>5,16</b>
3/8" NPT	<b>N122606</b>	<b>7,59</b>
1/2" NPT	<b>N122608</b>	<b>12,93</b>
3/4" NPT	<b>N122612</b>	<b>18,08</b>
1" NPT	<b>N122616</b>	<b>28,18</b>
1" 1/4 NPT	<b>N122620</b>	<b>53,65</b>
1" 1/2 NPT	<b>N122624</b>	<b>121,03</b>
2" NPT	<b>N122632</b>	<b>200,45</b>

# Thread data table

Tabla de roscas  
Tableau de raccords  
Tableau de raccords

## METRICA

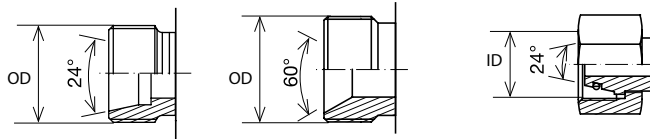

## JIC

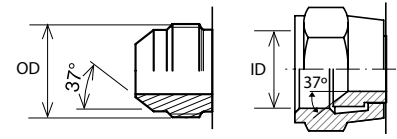

Métrica Metricale Métrique Metrica	Cono 24° 24° cone Cone 24° Cono 24°	Cono 60° 60° cone Cone 60° Cono 60°	Male thread OD	Female thread ID
12 x 1,5			12	10,5
14 x 1,5			14	12,5
16 x 1,5			16	14,5
18 x 1,5			18	16,5
20 x 1,5			20	18,5
22 x 1,5			22	20,5
24 x 1,5			24	22,5
26 x 1,5			26	24,5
30 x 1,5			30	28,5
30 x 2			30	28,00
36 x 2			36	34,00
38 x 1,5			38	36,5
42 x 2			42	40,00
45 x 1,5			45	43,5
45 x 2			45	43
52 x 1,5			52	50,5
52 x 2			52	50
65 x 2			65	63
78 x 2			78	76

SAE	Male thread OD	Female thread ID
7/16-20	11,07	10,00
1/2-20	12,70	11,60
9/16-18	14,25	13,00
5/8-18	15,85	14,70
3/4-16	19,00	17,60
7/8-14	22,17	20,50
1 1/16-12	26,95	25,00
1 1/16-14	26,95	25,30
1 5/16-12	33,30	31,30
1 5/16-14	33,30	31,60
1 5/8-12	41,42	39,20
1 5/8-14	41,22	39,50
1 7/8-12	47,57	45,60
1 7/8-14	47,57	45,90
2 1/2-12	63,45	61,50
3-12	76,20	74,30

## BSP

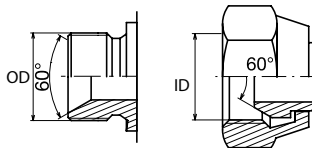

## NPT-BSPT-NPSM

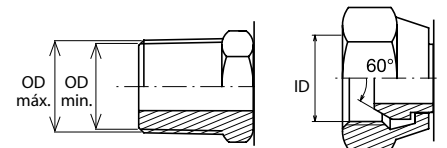

BSP	Male thread OD	Female thread iD
1/4-19	13,16	11,50
3/8-19	16,66	14,90
1/2-14	20,96	18,60
5/8-14	22,91	20,60
3/4-14	26,44	24,10
1-11	33,25	30,30
1 1/4-11	41,91	38,90
1 1/2-11	47,80	44,90
2-11	59,62	56,70

NPT cónicas Conical NPT NPT conique NPT conico	Male thread máx. OD	Male thread mín. OD	Female thread iD	BSPT cónicas Conical BSPT BSPT conique BSPT conico	Male thread máx. OD	Male thread mín. OD
1/8-27	10,59	9,98	8,6	1/8-28	10,20	9,48
1/4-18	14,12	13,28	11,9	1/4-19	13,90	12,85
3/8-18	17,55	16,71	15,0	3/8-19	17,31	16,26
1/2-14	21,84	21,08	19,1	1/2-14	21,89	20,55
3/4-14	27,17	26,13	24,6	3/4-14	27,30	25,84
1-11,5	33,96	32,74	30,5	1-11	34,41	32,65
1 1/4-11,5	42,72	41,47	39,4	1 1/4-11	42,91	41,11
1 1/2-11,5	48,81	47,54	45,5	1 1/2-11	48,83	47,08
2-11,5	60,88	59,56	57,4	2-11	60,94	58,62

## ORFS

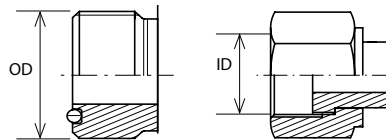

## BRIDAS

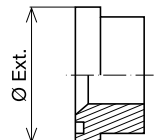

ORFS	Male thread OD	Female thread iD
9/16" 18h	14,25	13,0
11/16" 16h	17,40	15,4
13/16" 16h	20,05	18,6
1" 14h	25,30	23,1
1" 3/16 12h	30,10	27,5
1" 7/16 12h	36,40	33,8
1" 11/16 12h	42,80	40,2
2" 12h	50,70	48,1

Brida SAE	Ø ext. 3000 PSI	Ø ext. 6000 PSI
1/2"	30,2	31,8
3/4"	38,1	41,3
1"	44,5	47,6
1" 1/4	50,8	54,0
1" 1/2	60,3	63,5
2"	71,4	79,4

\* 9000 PSI flanges have the same Ø as 6000 PSI, but with thickness deck 14,3 / Las bridas 9000 PSI son iguales en Ø a las 6000 PSI, pero con espesor de pletina 14,3 / Die Flansche 9000 PSI sind im Ø gleich denen von 6000 PSI, aber mit der Plattendicke 14,3. / Les brides 9000 PSI son égales en Ø aux brides 6000 PSI, mais l'épaisseur est de 14,3 mm.

# Adaptadores ORFS

ORFS Adaptors  
Adapteurs ORFS  
Adattatori ORFS

## Tuerca ORFS

ORFS Nut

Ecrou ORFS

Dado ORFS

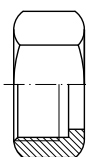

THREAD ROSCA	Part nº Referencia	€
ORFS 9/16"-18h	<b>OR1020400</b>	<b>0,83</b>
ORFS 11/16"-16h	<b>OR1020600</b>	<b>1,17</b>
ORFS 13/16"-16h	<b>OR1020800</b>	<b>1,37</b>
ORFS 1"-14h	<b>OR1021000</b>	<b>1,84</b>
ORFS 1"3/16-12h	<b>OR1021200</b>	<b>5,02</b>
ORFS 1"7/16-12h	<b>OR1021600</b>	<b>5,49</b>
ORFS 1"11/16-12h	<b>OR1022000</b>	<b>10,33</b>
ORFS 2"-12h	<b>OR1022400</b>	<b>11,91</b>

## Tapón macho ORFS

ORFS Male plug

Bouchon mâle ORFS

Tappo maschio ORFS

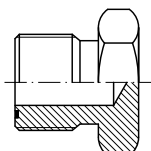

THREAD ROSCA	Part nº Referencia	€
ORFS 9/16"-18h	<b>OR1040400</b>	<b>1,36</b>
ORFS 11/16"-16h	<b>OR1040600</b>	<b>1,67</b>
ORFS 13/16"-16h	<b>OR1040800</b>	<b>2,21</b>
ORFS 1"-14h	<b>OR1041000</b>	<b>2,75</b>
ORFS 1"3/16-12h	<b>OR1041200</b>	<b>4,17</b>
ORFS 1"7/16-12h	<b>OR1041600</b>	<b>6,32</b>
ORFS 1"11/16-12h	<b>OR1042000</b>	<b>8,17</b>
ORFS 2"-12h	<b>OR1042400</b>	<b>20,19</b>

## Adaptador macho ORFS

ORFS-ORFS Male

Mâle ORFS-ORFS

Adattatore maschio ORFS

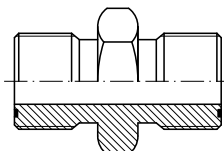

THREAD ROSCA	Part nº Referencia	€	
ORFS 9/16"-18h	ORFS 9/16"-18h	<b>OR2000404</b>	<b>2,35</b>
ORFS 11/16"-16h	ORFS 9/16"-18h	<b>OR2000604</b>	<b>2,61</b>
ORFS 11/16"-16h	ORFS 11/16"-16h	<b>OR2000606</b>	<b>3,00</b>
ORFS 13/16"-16h	ORFS 11/16"-16h	<b>OR2000806</b>	<b>3,91</b>
ORFS 13/16"-16h	ORFS 13/16"-16h	<b>OR2000808</b>	<b>3,91</b>
ORFS 1"-14h	ORFS 13/16"-16h	<b>OR2001008</b>	<b>5,21</b>
ORFS 1"-14h	ORFS 1"-14h	<b>OR2001010</b>	<b>5,27</b>
ORFS 1"3/16-12h	ORFS 1"-14h	<b>OR2001210</b>	<b>6,18</b>
ORFS 1"3/16-12h	ORFS 1"3/16-12h	<b>OR2001212</b>	<b>7,17</b>
ORFS 1"7/16-12h	ORFS 1"3/16-12h	<b>OR2001612</b>	<b>13,89</b>
ORFS 1"7/16-12h	ORFS 1"7/16-12h	<b>OR2001616</b>	<b>10,21</b>
ORFS 1"11/16-12h	ORFS 1"7/16-12h	<b>OR2002016</b>	<b>17,70</b>
ORFS 1"11/16-12h	ORFS 1"11/16-12h	<b>OR2002020</b>	<b>21,78</b>
ORFS 2"-12h	ORFS 2"-12h	<b>OR2002424</b>	<b>30,31</b>

## Cono soldar

ORFS Welding cone

Collet à souder ORFS

Ogiva a saldare ORFS

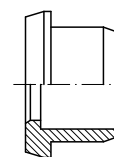

THREAD ROSCA	Part nº Referencia	€
ORFS 9/16"-18h	<b>OR12730406</b>	<b>1,62</b>
ORFS 11/16"-16h	<b>OR12730610</b>	<b>1,47</b>
ORFS 13/16"-16h	<b>OR12730812</b>	<b>1,79</b>
ORFS 1"-14h	<b>OR12731014</b>	<b>2,30</b>
ORFS 1"-14h	<b>OR12731015</b>	<b>2,30</b>
ORFS 1"-14h	<b>OR12731016</b>	<b>2,30</b>
ORFS 1"3/16-12h	<b>OR12731218</b>	<b>2,64</b>
ORFS 1"3/16-12h	<b>OR12731220</b>	<b>2,17</b>
ORFS 1"11/16-12h	<b>OR12732030</b>	<b>10,64</b>
ORFS 2"-12h	<b>OR12732438</b>	<b>11,06</b>

## Tapón hembra giratoria ORFS

ORFS Female cap

Bouchon femelle ORFS

Tappo femmina ORFS

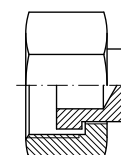

THREAD ROSCA	Part nº Referencia	€
ORFS 9/16"-18h	<b>OR1050400</b>	<b>1,65</b>
ORFS 11/16"-16h	<b>OR1050600</b>	<b>2,15</b>
ORFS 13/16"-16h	<b>OR1050800</b>	<b>2,62</b>
ORFS 1"-14h	<b>OR1051000</b>	<b>3,87</b>
ORFS 1"3/16-12h	<b>OR1051200</b>	<b>5,37</b>
ORFS 1"7/16-12h	<b>OR1051600</b>	<b>6,56</b>
ORFS 1"11/16-12h	<b>OR1052000</b>	<b>13,61</b>
ORFS 2"-12h	<b>OR1052400</b>	<b>19,36</b>

## Adaptador reductor hembra giratoria ORFS-macho ORFS

ORFS Swivel female-ORFS Male

Femelle tournante ORFS-mâle ORFS

Adattatore femmina girevole ORFS-maschio ORFS

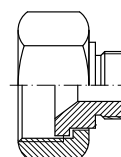

THREAD ROSCA	Part nº Referencia	€	
ORFS 11/16"-16h	ORFS 9/16"-18h	<b>OR3010604</b>	<b>4,36</b>
ORFS 13/16"-16h	ORFS 9/16"-18h	<b>OR3010804</b>	<b>5,72</b>
ORFS 13/16"-16h	ORFS 11/16"-16h	<b>OR3010806</b>	<b>5,47</b>
ORFS 1"-14h	ORFS 9/16"-18h	<b>OR3011004</b>	<b>9,07</b>
ORFS 1"-14h	ORFS 13/16"-16h	<b>OR3011008</b>	<b>9,07</b>
ORFS 1"3/16-12h	ORFS 11/16"-16h	<b>OR3011206</b>	<b>8,17</b>
ORFS 1"3/16-12h	ORFS 13/16"-16h	<b>OR3011208</b>	<b>8,85</b>
ORFS 1"3/16-12h	ORFS 1"-14h	<b>OR3011210</b>	<b>10,93</b>
ORFS 1"7/16-12h	ORFS 13/16"-16h	<b>OR3011608</b>	<b>14,58</b>
ORFS 1"7/16-12h	ORFS 1"-14h	<b>OR3011610</b>	<b>14,58</b>
ORFS 1"11/16-12h	ORFS 1"3/16-12h	<b>OR3012012</b>	<b>19,63</b>
ORFS 1"11/16-12h	ORFS 1"7/16-12h	<b>OR3012016</b>	<b>19,63</b>

# Adaptadores ORFS

ORFS Adaptors  
Adaptateurs ORFS  
Adattatori ORFS

## Adaptador macho ORFS-BSP

ORFS-BSP Male

Mâle ORFS-BSP

Adattatore maschio ORFS-BSP

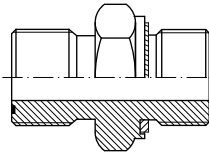

THREAD ROSCA		Part n° Referencia	€
ORFS 9/16"-18h	BSP 1/8"	<b>OR2020402</b>	<b>2,65</b>
ORFS 9/16"-18h	BSP 1/4"	<b>OR2020404</b>	<b>2,62</b>
ORFS 11/16"-16h	BSP 1/4"	<b>OR2020604</b>	<b>2,94</b>
ORFS 11/16"-16h	BSP 3/8"	<b>OR2020606</b>	<b>3,08</b>
ORFS 13/16"-16h	BSP 3/8"	<b>OR2020806</b>	<b>4,07</b>
ORFS 13/16"-16h	BSP 1/2"	<b>OR2020808</b>	<b>4,77</b>
ORFS 1"-14h	BSP 1/2"	<b>OR2021008</b>	<b>5,47</b>
ORFS 1"3/16-12h	BSP 3/4"	<b>OR2021212</b>	<b>7,17</b>
ORFS 1"7/16-12h	BSP 1"	<b>OR2021616</b>	<b>10,89</b>
ORFS 1"11/16-12h	BSP 1"1/4	<b>OR2022020</b>	<b>20,07</b>
ORFS 2"-12h	BSP 1"1/2	<b>OR2022424</b>	<b>45,37</b>

## Adaptador macho ORFS-hembra giratoria JIC

ORFS Male-JIC Swivel female

Mâle ORFS-femelle tournante JIC

Adattatore maschio ORFS-femmina girevole JIC

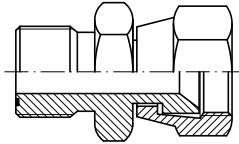

THREAD ROSCA		Part n° Referencia	€
ORFS 9/16"-18h	JIC 7/16"	<b>OR3020404</b>	<b>3,86</b>
ORFS 11/16"-16h	JIC 9/16"	<b>OR3020606</b>	<b>4,64</b>
ORFS 13/16"-16h	JIC 3/4"	<b>OR3020808</b>	<b>4,97</b>
ORFS 1"-14h	JIC 7/8"	<b>OR3021010</b>	<b>12,24</b>
ORFS 1"3/16-12h	JIC 1"1/16	<b>OR3021212</b>	<b>6,70</b>
ORFS 1"7/16-12h	JIC 1"5/16	<b>OR3021616</b>	<b>13,69</b>
ORFS 1"11/16-12h	JIC 1"5/8	<b>OR3022020</b>	<b>24,12</b>
ORFS 2"-12h	JIC 1"7/8	<b>OR3022424</b>	<b>45,80</b>

## Macho ORFS-Métrico

ORFS Metric Male

Mâle ORFS Métrique

Maschio ORFS Metrico

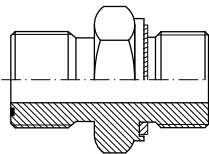

THREAD ROSCA		Part n° Referencia	€
ORFS 9/16"-18h	M12x1.5	<b>OR10170412</b>	<b>5,65</b>
ORFS 11/16"-16h	M14x1.5	<b>OR10170614</b>	<b>4,36</b>
ORFS 11/16"-16h	M16x1.5	<b>OR10170616</b>	<b>4,36</b>
ORFS 13/16"-16h	M18x1.5	<b>OR10170818</b>	<b>4,69</b>
ORFS 1"-14h	M22x1.5	<b>OR10171022</b>	<b>6,08</b>
ORFS 1"7/16-12h	M33x2	<b>OR10171633</b>	<b>12,57</b>
ORFS 1"11/16-12h	M42x2	<b>OR10172042</b>	<b>23,73</b>
ORFS 2"-12h	M48x2	<b>OR10172448</b>	<b>37,02</b>

## Adaptador macho ORFS-JIC

ORFS-JIC Male

Mâle ORFS-JIC

Adattatore maschio ORFS-JIC

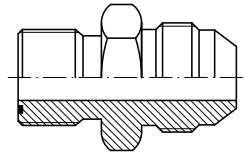

THREAD ROSCA		Part n° Referencia	€
ORFS 9/16"-18h	JIC 7/16"	<b>OR2040404</b>	<b>2,45</b>
ORFS 11/16"-16h	JIC 9/16"	<b>OR2040606</b>	<b>2,65</b>
ORFS 13/16"-16h	JIC 3/4"	<b>OR2040808</b>	<b>3,24</b>
ORFS 1"-14h	JIC 7/8"	<b>OR2041010</b>	<b>4,71</b>
ORFS 1"3/16-12h	JIC 1"1/16	<b>OR2041212</b>	<b>7,06</b>
ORFS 1"7/16-12h	JIC 1"5/16	<b>OR2041616</b>	<b>9,15</b>

## Pasatabiques ORFS

ORFS Bulkhead

Passe-doisson ORFS

Passaparete ORFS

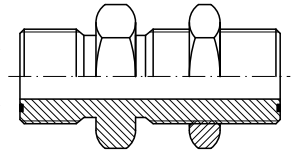

PIPE TUBO	THREAD ROSCA	Part n° Referencia	€
5	ORFS 9/16"-18h	<b>OR1060404</b>	<b>4,77</b>
6,5	ORFS 11/16"-16h	<b>OR1060606</b>	<b>6,13</b>
9,5	ORFS 13/16"-16h	<b>OR1060808</b>	<b>8,17</b>
12,5	ORFS 1"-14h	<b>OR1061010</b>	<b>9,52</b>
15,5	ORFS 1"3/16-12h	<b>OR1061212</b>	<b>14,30</b>
20,5	ORFS 1"7/16-12h	<b>OR1061616</b>	<b>24,22</b>
26	ORFS 1"11/16-12h	<b>OR1062020</b>	<b>33,27</b>
32	ORFS 2"-12h	<b>OR1062424</b>	<b>53,99</b>

## Hembra Giratoria ORFS - Racor Recto Macho BSP

ORFS swivel female - BSP male

Femelle tournante ORFS - Mâle BSP

Femmina girevole ORFS- Adattatore maschio BSP

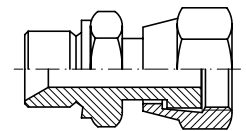

PIPE TUBO		THREAD ROSCA	Part n° Referencia	€
3,5	1/8" BSP	ORFS 9/16" 18h	<b>OR3030402</b>	<b>10,53</b>
6	1/4" BSP	ORFS 9/16" - 18h	<b>OR3030404</b>	<b>10,63</b>
6	1/4" BSP	ORFS 11/16" - 16h	<b>OR3030604</b>	<b>12,17</b>
8	3/8" BSP	ORFS 11/16" - 16h	<b>OR3030606</b>	<b>13,32</b>
8	3/8" BSP	ORFS 13/16" - 16h	<b>OR3030806</b>	<b>14,92</b>
11	1/2" BSP	ORFS 13/16" - 16h	<b>OR3030808</b>	<b>15,48</b>
11	1/2" BSP	ORFS 1" - 14h	<b>OR3031008</b>	<b>18,89</b>
16	3/4" BSP	ORFS 1"3/16 - 12h	<b>OR3031212</b>	<b>24,62</b>
22	1" BSP	ORFS 1"7/16 - 12h	<b>OR3031616</b>	<b>30,19</b>
28,5	1"1/4 BSP	ORFS 1"11/16 - 12h	<b>OR3032020</b>	<b>38,69</b>
33	1"1/2 BSP	ORFS 2" - 12h	<b>OR3032424</b>	<b>67,84</b>

# Adaptadores ORFS

ORFS Adaptors  
Adapteurs ORFS  
Adattatori ORFS

Adaptors

## Hembra Giratoria ORFS - Racor Recto Macho BSP con junta

ORFS swivel female - BSP male with o'ring

Femelle tournante ORFS - Mâle BSP avec o'ring

Femmina girevole ORFS- Adattatore maschio BSP + o'ring

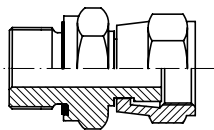

THREAD ROSCA		Part nº Referencia	€
3/8" BSP	ORFS 11/16" - 16h	<b>OR3130606</b>	<b>13,88</b>
1/2" BSP	ORFS 13/16" - 16h	<b>OR3130808</b>	<b>18,36</b>
3/4" BSP	ORFS 1"3/16 - 12h	<b>OR3131212</b>	<b>23,05</b>
1" BSP	ORFS 1"7/16 - 12h	<b>OR3131616</b>	<b>37,91</b>

## Adaptador Macho ORFS - Hembra Fija BSP

ORFS male adaptor - BSP fixed female

Adapteur mâle ORFS - femelle fixe BSP

Adattatore maschio ORFS - femmina fissa BSP

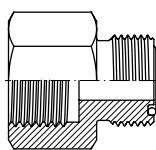

THREAD ROSCA		Part nº Referencia	€
ORFS 9/16"-18 h	BSP 1/4"	<b>OR3040404</b>	<b>3,33</b>
ORFS 11/16"-16h	BSP 3/8"	<b>OR3040606</b>	<b>4,03</b>
ORFS 13/16"-16 h	BSP 1/2"	<b>OR3040808</b>	<b>4,73</b>
ORFS 1"3/16-12 h	BSP 3/4"	<b>OR3041212</b>	<b>8,45</b>
ORFS 1"7/16-12 h	BSP 1"	<b>OR3041616</b>	<b>12,10</b>

## Codo 45° regulable ORFS-BSP

45° elbow ORFS male-Adjustable BSP male

Coude 45° mâle ORFS-mâle gaz cyl. +o'ring

Raccordo a 45° orientabile ORFS-BSP

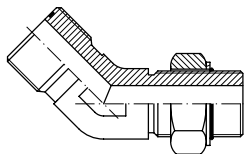

THREAD ROSCA		Part nº Referencia	€
ORFS 9/16"-18h	BSP 1/8"	<b>OR5010402</b>	<b>6,08</b>
ORFS 9/16"-18h	BSP 1/4"	<b>OR5010404</b>	<b>5,96</b>
ORFS 11/16"-16h	BSP 1/4"	<b>OR5010604</b>	<b>7,26</b>
ORFS 11/16"-16h	BSP 3/8"	<b>OR5010606</b>	<b>7,75</b>
ORFS 11/16"-16h	BSP 1/2"	<b>OR5010608</b>	<b>9,71</b>
ORFS 13/16"-16h	BSP 3/8"	<b>OR5010806</b>	<b>8,85</b>
ORFS 1"-14h	BSP 1/2"	<b>OR5011008</b>	<b>13,44</b>
ORFS 1"-14h	BSP 3/4"	<b>OR5011012</b>	<b>17,16</b>
ORFS 1"3/16-12h	BSP 3/4"	<b>OR5011212</b>	<b>19,07</b>
ORFS 1"3/16-12h	BSP 1"	<b>OR5011216</b>	<b>26,29</b>
ORFS 1"7/16-12h	BSP 1"	<b>OR5011616</b>	<b>29,77</b>

## Adaptador H.G. ORFS - Macho JIC

ORFS swivel female adaptor - JIC male

Adapteur femelle tournante ORFS - mâle JIC

Adattatore femmina girevole ORFS - maschio JIC

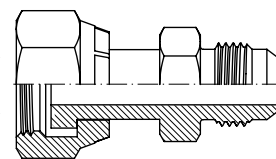

THREAD ROSCA		Part nº Referencia	€
JIC 7/16	ORFS 9/16"-18 h	<b>OR3050404</b>	<b>3,95</b>
JIC 9/16	ORFS 11/16"-16h	<b>OR3050606</b>	<b>5,04</b>
JIC 3/4"	ORFS 13/16"-16 h	<b>OR3050808</b>	<b>6,36</b>
JIC 1"1/16	ORFS 1"3/16-12 h	<b>OR3051212</b>	<b>11,55</b>
JIC 1" 5/16	ORFS 1"7/16-12 h	<b>OR3051616</b>	<b>17,14</b>

Quick-release couplings

Ball valves

Diverter

Swivel fittings

Multi-way couplings

Protections

## Codo 45° macho ORFS-hembra giratoria ORFS

45° elbow ORFS swivel female-ORFS male

Coude 45° mâle ORFS-femelle tournante ORFS

Raccordo a 45° maschio-femmina girevole ORFS

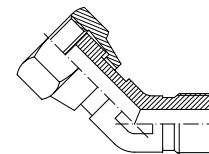

THREAD ROSCA		Part nº Referencia	€
ORFS 9/16"-18h	ORFS 9/16"-18h	<b>OR6010404</b>	<b>6,52</b>
ORFS 11/16"-16h	ORFS 11/16"-16h	<b>OR6010606</b>	<b>8,44</b>
ORFS 13/16"-16h	ORFS 13/16"-16h	<b>OR6010808</b>	<b>10,42</b>
ORFS 1"-14h	ORFS 1"-14h	<b>OR6011010</b>	<b>13,61</b>
ORFS 1"3/16-12h	ORFS 1"3/16-12h	<b>OR6011212</b>	<b>19,55</b>
ORFS 1"7/16-12h	ORFS 1"7/16-12h	<b>OR6011616</b>	<b>32,87</b>
ORFS 1"11/16	ORFS 1"11/16	<b>OR6012020</b>	<b>44,63</b>
ORFS 2"-12h	ORFS 2"-12h	<b>OR6012424</b>	<b>52,18</b>

# Adaptadores ORFS

ORFS Adaptors  
Adapteurs ORFS  
Adattatori ORFS

## Codo 90° ORFS-ORFS

90° Elbow ORFS male-ORFS male

Coude 90° mâle ORFS-mâle ORFS

Raccordo a 90° ORFS-ORFS

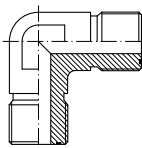

THREAD ROSCA		Part n° Referencia	€
ORFS 9/16"-18h	ORFS 9/16"-18h	<b>OR4050404</b>	<b>8,18</b>
ORFS 11/16"-16h	ORFS 11/16"-16h	<b>OR4050606</b>	<b>8,72</b>
ORFS 13/16"-16h	ORFS 13/16"-16h	<b>OR4050808</b>	<b>10,65</b>
ORFS 1"-14h	ORFS 1"-14h	<b>OR4051010</b>	<b>13,53</b>
ORFS 1"3/16-12h	ORFS 1"3/16-12h	<b>OR4051212</b>	<b>15,94</b>
ORFS 1"7/16-12h	ORFS 1"7/16-12h	<b>OR4051616</b>	<b>47,94</b>
ORFS 1"11/16-12h	ORFS 1"11/16-12h	<b>OR4052020</b>	<b>46,61</b>
ORFS 2"-12h	ORFS 2"-12h	<b>OR4052424</b>	<b>56,33</b>

## Codo 90° macho-hembra giratoria ORFS

90° Elbow ORFS Swivel female-ORFS male

Coude 90° femelle tournante-mâle ORFS

Raccordo a 90° maschio-femmina girevole ORFS

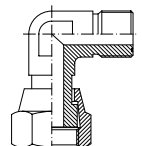

THREAD ROSCA		Part n° Referencia	€
ORFS 9/16"-18h	ORFS 9/16"-18h	<b>OR6000404</b>	<b>5,72</b>
ORFS 11/16"-16h	ORFS 11/16"-16h	<b>OR6000606</b>	<b>7,49</b>
ORFS 13/16"-16h	ORFS 13/16"-16h	<b>OR6000808</b>	<b>8,10</b>
ORFS 1"-14h	ORFS 1"-14h	<b>OR6001010</b>	<b>11,92</b>
ORFS 1"3/16-12h	ORFS 1"3/16-12h	<b>OR6001212</b>	<b>17,43</b>
ORFS 1"7/16-12h	ORFS 1"7/16-12h	<b>OR6001616</b>	<b>20,82</b>
ORFS 1"11/16-12h	ORFS 1"11/16-12h	<b>OR6002020</b>	<b>40,76</b>

## Codo 90° pasatabique ORFS

90° Elbow ORFS Bulkhead

Coude 90° passe-cloison ORFS

Raccordo a 90° passaparete ORFS

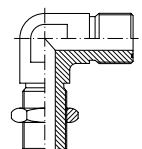

THREAD ROSCA		Part n° Referencia	€
ORFS 9/16"-18h	ORFS 9/16"-18h	<b>OR4030404</b>	<b>17,57</b>
ORFS 11/16"-16h	ORFS 11/16"-16h	<b>OR4030606</b>	<b>16,83</b>
ORFS 1"-14h	ORFS 1"-14h	<b>OR4031010</b>	<b>28,48</b>
ORFS 1"3/16-12h	ORFS 1"3/16-12h	<b>OR4031212</b>	<b>36,10</b>
ORFS 1"7/16-12h	ORFS 1"7/16-12h	<b>OR4031616</b>	<b>58,55</b>
ORFS 1"11/16-12h	ORFS 1"11/16-12h	<b>OR4032020</b>	<b>53,75</b>
ORFS 2"-12h	ORFS 2"-12h	<b>OR4032424</b>	<b>89,97</b>

## Codo 90° ORFS-BSP macho regulable

90° elbow ORFS male-Adjustable BSP male

Coude 90° mâle ORFS + mâle gaz cyl. +o'ring

Raccordo a 90° regolabile ORFS-BSP

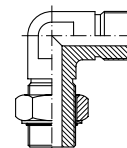

THREAD ROSCA		Part n° Referencia	€
ORFS 9/16"-18h	BSP 1/8"	<b>OR4010402</b>	<b>11,01</b>
ORFS 9/16"-18h	BSP 1/4"	<b>OR4010404</b>	<b>10,86</b>
ORFS 9/16"-18h	BSP 3/8"	<b>OR4010406</b>	<b>18,95</b>
ORFS 11/16"-16h	BSP 1/4"	<b>OR4010604</b>	<b>10,16</b>
ORFS 11/16"-16h	BSP 3/8"	<b>OR4010606</b>	<b>11,34</b>
ORFS 13/16"-16h	BSP 1/4"	<b>OR4010804</b>	<b>10,75</b>
ORFS 13/16"-16h	BSP 1/2"	<b>OR4010808</b>	<b>15,70</b>
ORFS 1"-14h	BSP 3/8"	<b>OR4011006</b>	<b>15,34</b>
ORFS 1"-14h	BSP 1/2"	<b>OR4011008</b>	<b>14,98</b>
ORFS 1"3/16-12h	BSP 1/2"	<b>OR4011208</b>	<b>18,95</b>
ORFS 1"3/16-12h	BSP 3/4"	<b>OR4011212</b>	<b>19,94</b>
ORFS 1"3/16-12h	BSP 1"	<b>OR4011216</b>	<b>42,28</b>
ORFS 1"7/16-12h	BSP 1"	<b>OR4011616</b>	<b>34,10</b>
ORFS 1"7/16-12h	BSP 1" 1/4	<b>OR4011620</b>	<b>55,73</b>
ORFS 1"11/16-12h	BSP 1"	<b>OR4012016</b>	<b>48,18</b>
ORFS 1"11/16-12h	BSP 1"1/4	<b>OR4012020</b>	<b>55,73</b>
ORFS 2"-12h	BSP 1"1/2	<b>OR4012424</b>	<b>71,21</b>

## Codo 90° Macho ORFS - Macho NPT (60°)

90° Elbow ORFS male - NPT male (60°)

Coude 90° mâle ORFS - mâle NPT (60°)

Raccordo a 90° maschio ORFS - maschio NPT (60°)

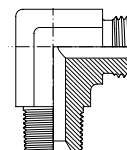

THREAD ROSCA		Part n° Referencia	€
ORFS 9/16"-18 h	1/4" NPT	<b>OR4040404</b>	<b>4,27</b>
ORFS 11/16"-16h	3/8" NPT	<b>OR4040606</b>	<b>5,82</b>
ORFS 13/16"-16 h	1/2" NPT	<b>OR4040808</b>	<b>8,92</b>
ORFS 1"3/16-12 h	3/4" NPT	<b>OR4041212</b>	<b>18,22</b>
ORFS 1"7/16-12 h	1" NPT	<b>OR4041616</b>	<b>27,29</b>

# Adaptadores ORFS

ORFS Adaptors  
Adapteurs ORFS  
Adattatori ORFS

Adaptors

Quick-release couplings

Ball valves

Diverter

Swivel fittings

Multi-way couplings

Protections

## Te Macho ORFS

*Tee ORFS male*

Té égal mâle ORFS

*Raccordo a T maschio ORFS*

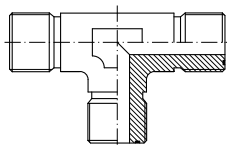

THREAD ROSCA	Part nº Referencia	€
ORFS 9/16"-18h	<b>OR7000404</b>	<b>9,44</b>
ORFS 11/16"-16h	<b>OR7000606</b>	<b>12,33</b>
ORFS 13/16"-16h	<b>OR7000808</b>	<b>13,18</b>
ORFS 1"-14h	<b>OR7001010</b>	<b>17,50</b>
ORFS 1"3/16-12h	<b>OR7001212</b>	<b>19,19</b>
ORFS 1"7/16-12h	<b>OR7001616</b>	<b>45,89</b>
ORFS 1"11/16-12h	<b>OR7002020</b>	<b>45,48</b>
ORFS 2"-12h	<b>OR7002424</b>	<b>85,42</b>

## Te macho-hembra giratoria-macho ORFS

*ORFS Brunch tee male-swivel female-male*

Té mâle-femelle tournante-mâle ORFS

*Raccordo a T maschio-maschio-femmina girevole centrale ORFS*

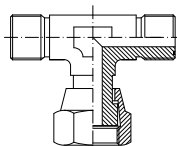

THREAD ROSCA	Part nº Referencia	€
ORFS 9/16"-18h	<b>OR7010404</b>	<b>15,88</b>
ORFS 11/16"-16h	<b>OR7010606</b>	<b>18,95</b>
ORFS 13/16"-16h	<b>OR7010808</b>	<b>17,19</b>
ORFS 1"-14h	<b>OR7011010</b>	<b>26,07</b>
ORFS 1"3/16-12h	<b>OR7011212</b>	<b>34,34</b>
ORFS 1"7/16-12h	<b>OR7011616</b>	<b>64,90</b>
ORFS 1"11/16-12h	<b>OR7012020</b>	<b>94,49</b>
ORFS 2"-12h	<b>OR7012424</b>	<b>142,53</b>

## Te macho-macho-hembra giratoria ORFS

*ORFS Barrel tee male-male-swivel female*

Té mâle-mâle-femelle tournante ORFS

*Raccordo a T maschio-maschio-femmina girevole laterale ORFS*

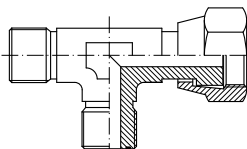

THREAD ROSCA	Part nº Referencia	€
ORFS 9/16"-18h	<b>OR7020404</b>	<b>7,39</b>
ORFS 11/16"-16h	<b>OR7020606</b>	<b>7,99</b>
ORFS 13/16"-16h	<b>OR7020808</b>	<b>12,72</b>
ORFS 1"-14h	<b>OR7021010</b>	<b>15,05</b>
ORFS 1"3/16-12h	<b>OR7021212</b>	<b>21,28</b>
ORFS 1"7/16-12h	<b>OR7021616</b>	<b>36,48</b>
ORFS 1"11/16-12h	<b>OR7022020</b>	<b>62,86</b>

## Te macho ORFS-macho BSP-macho ORFS

*Brunch tee ORFS male- Adjustable BSP male- ORFS male*

Té mâle ORFS-mâle BSP-mâle ORFS

*Raccordo a T maschio ORFS-maschio BSP-maschio ORFS*

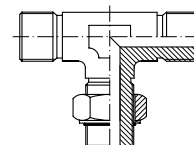

THREAD ROSCA		Part nº Referencia	€
ORFS 9/16"-18h	BSP 1/8"	<b>OR7030402</b>	<b>6,26</b>
ORFS 9/16"-18h	BSP 1/4"	<b>OR7030404</b>	<b>9,52</b>
ORFS 11/16"-16h	BSP 1/4"	<b>OR7030604</b>	<b>9,34</b>
ORFS 11/16"-16h	BSP 3/8"	<b>OR7030606</b>	<b>10,97</b>
ORFS 13/16"-16h	BSP 3/8"	<b>OR7030806</b>	<b>10,06</b>
ORFS 1"-14h	BSP 1/2"	<b>OR7031008</b>	<b>14,96</b>
ORFS 1"-14h	BSP 3/4"	<b>OR7031012</b>	<b>20,49</b>
ORFS 1"3/16-12h	BSP 3/4"	<b>OR7031212</b>	<b>24,13</b>
ORFS 1"7/16-12h	BSP 1"	<b>OR7031616</b>	<b>34,72</b>
ORFS 1"11/16-12h	BSP 1"1/4"	<b>OR7032020</b>	<b>49,23</b>

## Te macho ORFS-macho ORFS-macho BSP

*Barrel tee ORFS male-ORFS male- Adjustable BSP male*

Té mâle ORFS-mâle ORFS-mâle BSP

*Raccordo a T maschio ORFS-maschio ORFS-maschio BSP*

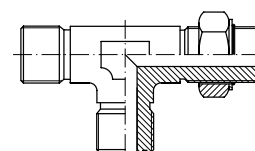

THREAD ROSCA		Part nº Referencia	€
ORFS 9/16"-18h	BSP 1/8"	<b>OR7040402</b>	<b>17,22</b>
ORFS 9/16"-18h	BSP 1/4"	<b>OR7040404</b>	<b>11,50</b>
ORFS 11/16"-16h	BSP 1/4"	<b>OR7040604</b>	<b>14,98</b>
ORFS 11/16"-16h	BSP 3/8"	<b>OR7040606</b>	<b>16,74</b>
ORFS 1"-14h	BSP 3/4"	<b>OR7041012</b>	<b>27,30</b>
ORFS 1"11/16-12h	BSP 1"1/4"	<b>OR7042020</b>	<b>65,71</b>
ORFS 2"-12h	BSP 1"1/2"	<b>OR7042424</b>	<b>65,35</b>

## Enchufes rápidos

*Quick-release couplings*

Coupleurs rapides

*Innesti rapidi*

### Enchufes rápidos DNP

*DNP Quick-release couplings*

Coupleurs rapides DNP

*Innesti rapidi DNP*

317

### Enchufes rápidos TrΔle

*TrΔle quick-release couplings*

Coupleurs rapides TrΔle

*Innesti rapidi TrΔle*

325

2

# Enchufes rápidos DNP

DNP Quick-release couplings  
Coupleurs rapides DNP  
Innesti rapidi DNP

## ■ Enchufes cara plana / Flat face quick release couplings / Coupleurs rapides à clapet face plane / Innesti a faccia piana | 317

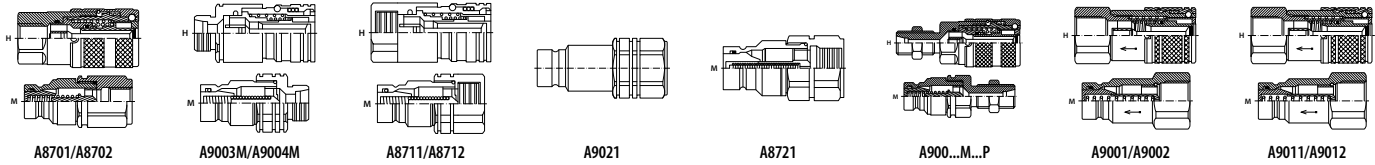

## ■ Enchufes autorroscantes / Quick release screw couplings / Coupleurs rapides à visser / Innesti a vite | 318

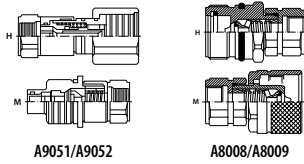

## ■ Enchufes punzón / Quick release couplings / Coupleurs rapides à clapet / Innesti a valvola | 319

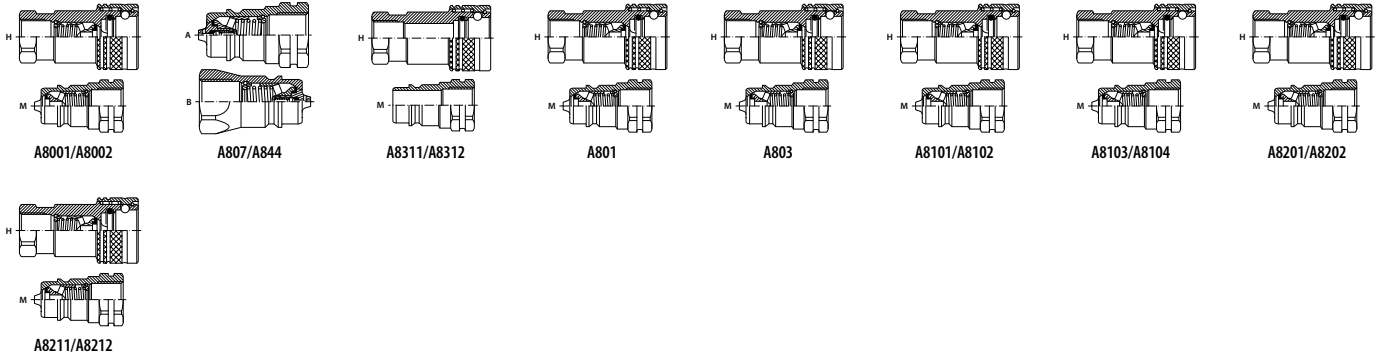

## ■ Enchufes Push-Pull / Push-Pull couplings / Coupleurs Push-Pull / Innesti Push-Pull | 321

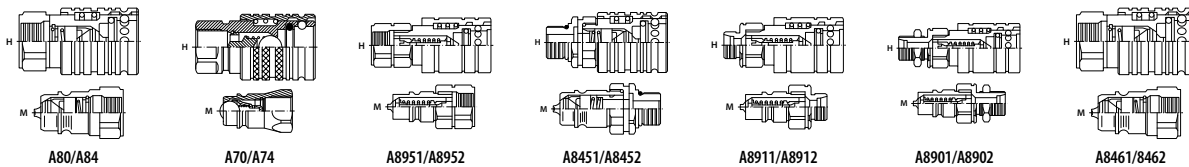

## ■ Enchufes de bola / Quick release couplings ball type / Coupleurs rapides à bille / Innesti a sfera | 322

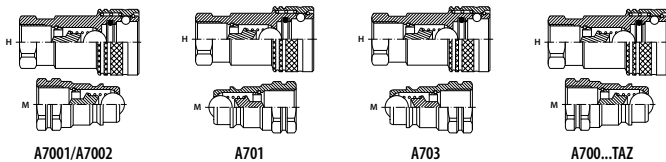

## ■ Enchufes altísima presión / Couplings 1500 bar / Coupleurs 1500 bar / Innesti 1500 bar | 322

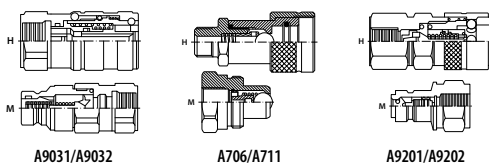

## ■ Válvulas de frenado / Brake valves / Valves freinaje / Valvole di frenaggio | 323

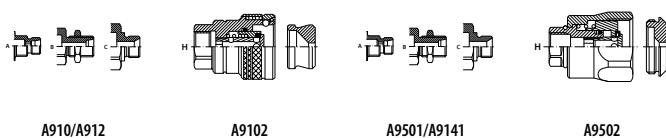

# Enchufes rápidos DNP

*DNP Quick-release couplings*

*Coupleurs rapides DNP*

*Innesti rapidi DNP*

## ■ Enchufes latón / Brass couplings / Coupleurs laiton / Innesti ottone

| 323

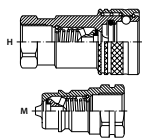

A850



PTFEA



NBRA

## ■ Accesorios para enchufes / Accessories for couplings / Accessoires pour coupleurs rapides / Accessori per innesto rapido

| 324



A9901/A9902



A9911/A9912



A9931/A9932



A9941/A9942



A9921



A9951/A9952

# Enchufes rápidos TrΔle

*TrΔle quick-release couplings*

*Coupleurs rapides TrΔle*

*Innesti rapidi TrΔle*

- Enchufes punzón TrΔle / TrΔle quick release couplings / Coupleurs rapides à clapet TrΔle / Innesti a valvola TrΔle | 325

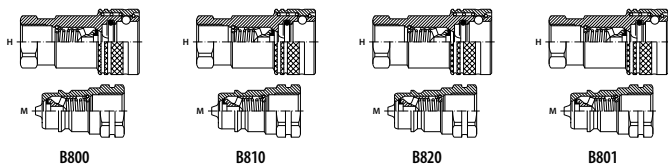

B800

B810

B820

B801

- Enchufes válvula plana y válvulas de frenado TrΔle / TrΔle flat face quick release couplings and brake valves / Coupleurs rapides à clapet face plane TrΔle / Innesti a faccia piana e valvole di frenaggio TrΔle | 325

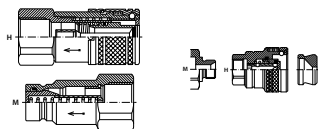

B900

B910

- Enchufes Push-Pull TrΔle / TrΔle Push-Pull couplings / Coupleurs Push-Pull TrΔle / Innesti Push-Pull TrΔle | 326

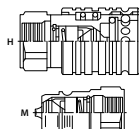

B840

- Accesorios para enchufes TrΔle / Accessories for TrΔle couplings / Accessoires pour coupleurs rapides TrΔle / Accessori per innesto rapido TrΔle | 326



B990

B991

# Enchufes rápidos DNP

DNP Quick-release couplings  
Coupleurs rapides DNP  
Innesti rapidi DNP

## E.R. cara plana para martillos BSP

Flat face quick release coupling inner threads BSP

Coupleur rapide à clapet face plane (marteau) BSP

Innesto rapido a faccia piana per martelli BSP

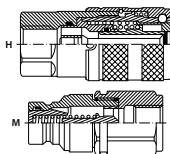

THREAD ROSCA	ISO SIZE TAMAÑO ISO	BG SIZE TAMAÑO BG	C. E.	Part nº Referencia	€
1/4" BSP	6.3	1	M	<b>A870104</b>	<b>17,47</b>
3/8" BSP	10	2	M	<b>A870106</b>	<b>18,86</b>
1/2" BSP	10	2	M	<b>A870108</b>	<b>19,24</b>
1/2" BSP	12.5	3	M	<b>A87011208</b>	<b>33,28</b>
3/4" BSP	12.5	3	M	<b>A870112</b>	<b>34,94</b>
3/4" BSP	16	4A	M	<b>A87011612</b>	<b>33,28</b>
1" BSP	19	4	M	<b>A870116</b>	<b>67,11</b>
1" 1/4 BSP	25	5	M	<b>A870120</b>	<b>110,92</b>
1/4" BSP	6.3	1	F	<b>A870204</b>	<b>36,71</b>
3/8" BSP	10	2	F	<b>A870206</b>	<b>44,76</b>
1/2" BSP	10	2	F	<b>A870208</b>	<b>44,76</b>
1/2" BSP	12.5	3	F	<b>A87021208</b>	<b>68,88</b>
3/4" BSP	12.5	3	F	<b>A870212</b>	<b>60,73</b>
3/4" BSP	16	4A	F	<b>A87021612</b>	<b>83,19</b>
1" BSP	19	4	F	<b>A870216</b>	<b>126,45</b>
1" 1/4 BSP	25	5	F	<b>A870220</b>	<b>206,92</b>

## E.R. cara plana para martillos (rosca Métrica)

Flat face coupling (Metric thread)

Coupleur rapide à clapet face plane (filetage Métrique)

Innesto a faccia piana (Metrico)

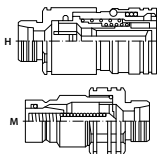

THREAD ROSCA	ISO SIZE TAMAÑO ISO	BG SIZE TAMAÑO BG	C. E.	Part nº Referencia	€
M16X1.5-10L	6.3	1	M	<b>A9003M16</b>	<b>18,84</b>
M18X1.5-12L	10	2	M	<b>A9003M18</b>	<b>19,74</b>
M22X1.5-15L	10	2	M	<b>A9003M22</b>	<b>20,75</b>
M26X1.5-18L	12.5	3	M	<b>A9003M26</b>	<b>41,87</b>
M16X1.5-10L	6.3	1	F	<b>A9004M16</b>	<b>51,08</b>
M18X1.5-12L	10	2	F	<b>A9004M18</b>	<b>57,42</b>
M22X1.5-15L	10	2	F	<b>A9004M22</b>	<b>60,41</b>
M26X1.5-18L	12.5	3	F	<b>A9004M26</b>	<b>86,12</b>

## E.R. cara plana para martillos (rosca UNF)

Flat face quick release coupling inner threads (UNF thread)

Coupleur rapide à clapet face plane pour marteau (filetage UNF)

Innesto rapido a faccia piana per martelli (filetatura UNF)

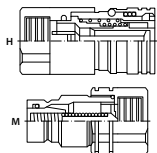

THREAD ROSCA	ISO SIZE TAMAÑO ISO	BG SIZE TAMAÑO BG	C. E.	Part nº Referencia	€
9/16"-18h UNF	6.3	1	M	<b>A87110906</b>	<b>17,47</b>
9/16"-18h UNF	10	2	M	<b>A87110913</b>	<b>18,58</b>
3/4"-16h UNF	10	2	M	<b>A87111213</b>	<b>26,62</b>
7/8"-14h UNF	12.5	3	M	<b>A87111420</b>	<b>38,82</b>
1"1/16-12h UNF	16	3	M	<b>A87111722</b>	<b>40,76</b>
1"1/16-12h UNF	19	4	M	<b>A87111725</b>	<b>67,11</b>
9/16"-18h UNF	6.3	1	F	<b>A87120906</b>	<b>46,59</b>
9/16"-18h UNF	10	2	F	<b>A87120913</b>	<b>56,01</b>
3/4"-16h UNF	10	2	F	<b>A87121213</b>	<b>59,90</b>
7/8"-14h UNF	12.5	3	F	<b>A87121420</b>	<b>84,85</b>
1"1/16-12h UNF	16	3	F	<b>A87121722</b>	<b>93,17</b>
1"1/16-12h UNF	19	4	F	<b>A87121725</b>	<b>139,76</b>

## E.R. cara plana Ecológico acoplamiento en presión BSP

Flat face quick release coupling connectable w/ pressure BSP

Coupleur rapide à clapet face plane "Ecologique" pression BSP

Innesto rapido a faccia piana Ecologica innestabile in pressione BSP

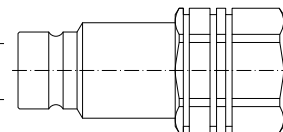

THREAD ROSCA	ISO SIZE TAMAÑO ISO	BG SIZE TAMAÑO BG	C. E.	Part nº Referencia	€
1/4" BSP	6.3	1	M	<b>A902104</b>	<b>69,32</b>
3/8" BSP	10	2	M	<b>A902106</b>	<b>66,55</b>
1/2" BSP	10	2	M	<b>A902108</b>	<b>66,55</b>
1/2" BSP	12.5	3	M	<b>A90211208</b>	<b>108,14</b>
3/4" BSP	12.5	3	M	<b>A902112</b>	<b>108,14</b>
3/4" BSP	19	4	M	<b>A90211612</b>	<b>151,40</b>
1" BSP	19	4	M	<b>A902116</b>	<b>154,73</b>

Se montan con enchufe hembra A870 / To assemble with female coupling A870 / À monter avec coupleur femelle A870 / Per montare con innesto femmina A870

## E.R. cara plana para martillos altas pulsaciones BSP

Flat face quick release coupling inner threads high pulsations BSP

Coupleur rapide à clapet face plane (marteau) hautes pulsations BSP

Innesto rapido a faccia piana per martelli alti pulsazioni BSP

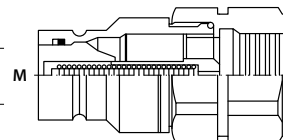

THREAD ROSCA	ISO SIZE TAMAÑO ISO	BG SIZE TAMAÑO BG	C. E.	Part nº Referencia	€
3/4" BSP	19	4	M	<b>A872112</b>	<b>88,73</b>
1" BSP	25	4	M	<b>A872116</b>	<b>88,73</b>

Se montan con enchufe hembra A870 / To assemble with female coupling A870 / À monter avec coupleur femelle A870 / Per montare con innesto femmina A870

## E.R. cara plana pasatabique para martillos (rosca Métrica)

Flat face coupling bulkhead (Metric thread)

Coupleur rapide à clapet face plane passe cloison (filetage Métrique)

Innesto a faccia piana passaparete (Metrico)

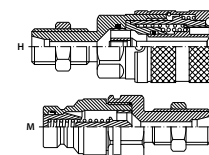

THREAD ROSCA	ISO SIZE TAMAÑO ISO	BG SIZE TAMAÑO BG	C. E.	Part nº Referencia	€
M16x1.5	6.3	1	M	<b>A9001M16P</b>	<b>20,41</b>
M18x1.5	10	2	M	<b>A9001M18P</b>	<b>22,18</b>
M22X1.5	10	2	M	<b>A9001M22P</b>	<b>22,18</b>
M26x1.5	12.5	3	M	<b>A9001M26P</b>	<b>51,85</b>
M16x1.5	6.3	1	F	<b>A9002M16P</b>	<b>54,18</b>
M18x1.5	10	2	F	<b>A9002M18P</b>	<b>61,01</b>
M22X1.5	10	2	F	<b>A9002M22P</b>	<b>64,89</b>
M26x1.5	12.5	3	F	<b>A9002M26P</b>	<b>93,17</b>

# Enchufes rápidos DNP

DNP Quick-release couplings  
Coupleurs rapides DNP  
Innesti rapidi DNP

## E.R. cara plana Ecológico (rosca BSP) - ISO16028

BSP Ecological flat face coupling-- ISO16028

Coupleur rapide à clapet face plane  
"Ecologique" filetage BSP- ISO16028

Innesto rapido a faccia piana Ecologico BSP--  
ISO16028

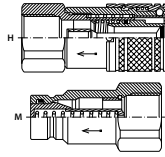

THREAD ROSCA	ISO SIZE TAMAÑO ISO	BG SIZE TAMAÑO BG	C. E.	Part nº Referencia	€
1/4" BSP	6.3	1	M	<b>A900104</b>	<b>16,36</b>
3/8" BSP	10	2	M	<b>A900106</b>	<b>16,64</b>
1/2" BSP	10	2	M	<b>A900108</b>	<b>16,64</b>
1/2" BSP	12.5	3	M	<b>A90011208</b>	<b>37,26</b>
3/4" BSP	12.5	3	M	<b>A900112</b>	<b>35,49</b>
1" BSP	19	4	M	<b>A900116</b>	<b>61,01</b>
1" 1/4 BSP	25	5	M	<b>A900120</b>	<b>116,46</b>
1" 1/2 BSP	40	7	M	<b>A900124</b>	<b>269,53</b>
2" BSP	50	8	M	<b>A900132</b>	<b>686,58</b>
1/4" BSP	6.3	1	F	<b>A900204</b>	<b>34,33</b>
3/8" BSP	10	2	F	<b>A900206</b>	<b>38,82</b>
1/2" BSP	10	2	F	<b>A900208</b>	<b>38,82</b>
1/2" BSP	12.5	3	F	<b>A90021208</b>	<b>70,01</b>
3/4" BSP	12.5	3	F	<b>A900212</b>	<b>55,40</b>
1" BSP	19	4	F	<b>A900216</b>	<b>128,66</b>
1" 1/4 BSP	25	5	F	<b>A900220</b>	<b>205,75</b>
1" 1/2 BSP	40	7	F	<b>A900224</b>	<b>454,76</b>
2" BSP	50	8	F	<b>A900232</b>	<b>987,16</b>

## E.R. cara plana Ecológico (rosca NPT)

NPT Ecological flat face coupling

Coupleur rapide à clapet face plane  
"Ecologique" filetage NPT

Innesto rapido a faccia piana Ecologico NPT

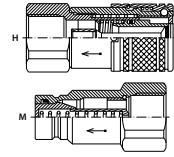

THREAD ROSCA	ISO SIZE TAMAÑO ISO	BG SIZE TAMAÑO BG	C. E.	Part nº Referencia	€
1/4" NPT	6.3	1	M	<b>A901104</b>	<b>16,36</b>
3/8" NPT	10	2	M	<b>A901106</b>	<b>16,64</b>
1/2" NPT	10	2	M	<b>A901108</b>	<b>16,64</b>
3/4" NPT	12.5	3	M	<b>A901112</b>	<b>35,49</b>
1" NPT	19	4	M	<b>A901116</b>	<b>61,01</b>
1" 1/4 NPT	25	5	M	<b>A901120</b>	<b>116,46</b>
1" 1/2 NPT	40	7	M	<b>A901124</b>	<b>232,93</b>
2" NPT	50	8	M	<b>A901132</b>	<b>686,58</b>
1/4" NPT	6.3	1	F	<b>A901204</b>	<b>38,82</b>
3/8" NPT	10	2	F	<b>A901206</b>	<b>40,49</b>
1/2" NPT	10	2	F	<b>A901208</b>	<b>40,49</b>
3/4" NPT	12.5	3	F	<b>A901212</b>	<b>62,11</b>
1" NPT	19	4	F	<b>A901216</b>	<b>146,41</b>
1" 1/4 NPT	25	5	F	<b>A901220</b>	<b>205,75</b>
1" 1/2 NPT	40	7	F	<b>A901224</b>	<b>410,39</b>
2" NPT	50	8	F	<b>A901232</b>	<b>987,16</b>

## E.R. cara plana Autorroscantes acoplamiento en presión (rosca BSP)

BSP flat face screw coupling u/pressure

Coupleur rapide à clapet face plane à visser  
pression (filetage BSP)

Innesto rapido faccia piana a vite in pressione

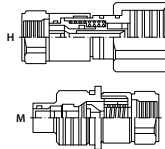

THREAD ROSCA	ISO SIZE TAMAÑO ISO	BG SIZE TAMAÑO BG	C. E.	Part nº Referencia	€
1/4" BSP	6.3	1	M	<b>A905104</b>	<b>117,30</b>
3/8" BSP	10	2	M	<b>A905106</b>	<b>103,15</b>
1/2" BSP	12.5	3	M	<b>A905108</b>	<b>129,22</b>
3/4" BSP	16	4	M	<b>A905112</b>	<b>134,76</b>
1" BSP	19	5	M	<b>A905116</b>	<b>165,27</b>
1" 1/4 BSP	25	6	M	<b>A905120</b>	<b>278,96</b>
1" 1/2 BSP	40	7	M	<b>A905124</b>	<b>561,96</b>
1/4" BSP	6.3	1	F	<b>A905204</b>	<b>88,73</b>
3/8" BSP	10	2	F	<b>A905206</b>	<b>73,76</b>
1/2" BSP	12.5	3	F	<b>A905208</b>	<b>88,73</b>
3/4" BSP	16	4	F	<b>A905212</b>	<b>98,72</b>
1" BSP	19	5	F	<b>A905216</b>	<b>124,78</b>
1" 1/4 BSP	25	6	F	<b>A905220</b>	<b>193,00</b>
1" 1/2 BSP	40	7	F	<b>A905224</b>	<b>640,55</b>

## E.R. Punzón Autorroscantes acoplamiento en presión (rosca BSP)

BSP Quick release screw coupling

Coupleur rapide à visser taraudage norme DIN  
forme y filetage BSP

Innesto rapido a vite (BSP)

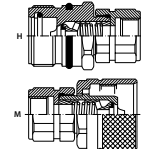

THREAD ROSCA	ISO SIZE TAMAÑO ISO	BG SIZE TAMAÑO BG	C. E.	Part nº Referencia	€
1/4" BSP	M28x2	10	2	M <b>A800804</b>	<b>20,24</b>
3/8" BSP	M28x2	10	2	M <b>A800806</b>	<b>20,24</b>
1/2" BSP	M36x2	12.5	3	M <b>A800808</b>	<b>21,08</b>
3/4" BSP	M42x2	19	4	M <b>A800812</b>	<b>49,36</b>
1" BSP	M48x3	25	5	M <b>A800816</b>	<b>61,56</b>
1" 1/4 BSP	M70x3	31.5T	6	M <b>A805820</b>	<b>227,38</b>
1" 1/2 BSP	M70x3	31.5T	6	M <b>A805824</b>	<b>221,83</b>
1/4" BSP	M28x2	10	2	F <b>A800904</b>	<b>20,24</b>
3/8" BSP	M28x2	10	2	F <b>A800906</b>	<b>20,24</b>
1/2" BSP	M36x2	12.5	3	F <b>A800908</b>	<b>20,35</b>
3/4" BSP	M42x2	19	4	F <b>A800912</b>	<b>47,81</b>
1" BSP	M48x3	25	5	F <b>A800916</b>	<b>52,13</b>
1" 1/4 BSP	M70x3	31.5T	6	F <b>A805920</b>	<b>204,75</b>
1" 1/2 BSP	M70x3	31.5T	6	F <b>A805924</b>	<b>177,47</b>

# Enchufes rápidos DNP

DNP Quick-release couplings  
Coupleurs rapides DNP  
Innesti rapidi DNP

## E.R. Punzón ISO A

ISO A Quick release coupling

Coupleur rapide à clapet norme ISO A

Innesto rapido a valvola ISO A

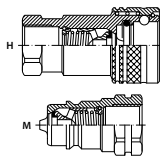

THREAD ROSCA	ISO SIZE TAMAÑO ISO	BG SIZE TAMAÑO BG	C. E.	Part n° Referencia	€
1/4" BSP	6.3	1	M	<b>A800104</b>	<b>6,38</b>
3/8" BSP	10	2	M	<b>A800106</b>	<b>6,71</b>
1/2" BSP	12.5	3	M	<b>A800108</b>	<b>6,71</b>
M22X1.5	12.5	3	M	<b>A802122</b>	<b>7,49</b>
3/4" BSP	20	4	M	<b>A800112</b>	<b>12,76</b>
1" BSP	25	5	M	<b>A800116</b>	<b>29,39</b>
1"1/4 BSP	31.5	6	M	<b>A800120</b>	<b>85,41</b>
1"1/2 BSP	40	7	M	<b>A800124</b>	<b>115,91</b>
2" BSP	50	8	M	<b>A800132</b>	<b>197,43</b>
1/4" BSP	6.3	1	F	<b>A800204</b>	<b>13,31</b>
3/8" BSP	10	2	F	<b>A800206</b>	<b>14,97</b>
1/2" BSP	12.5	3	F	<b>A800208</b>	<b>18,30</b>
3/4" BSP	20	4	F	<b>A800212</b>	<b>27,73</b>
M22X1.5	12.5	3	F	<b>A802222</b>	<b>19,41</b>
1" BSP	25	5	F	<b>A800216</b>	<b>61,01</b>
1"1/4 BSP	31.5	6	F	<b>A800220</b>	<b>175,25</b>
1"1/2 BSP	40	7	F	<b>A800224</b>	<b>236,25</b>
2" BSP	50	8	F	<b>A800232</b>	<b>547,38</b>

## E.R. Punzón ISO A -acoplamiento a presión residual

ISO A Quick release coupling (coupling under residual pressure)

Coupleur rapide à clapet accouplable sous pression résiduelle

Innesto rapido a valvole ISO a innestabili in pressione residua

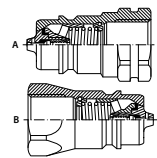

THREAD ROSCA	ISO SIZE TAMAÑO ISO	BG SIZE TAMAÑO BG	C. E.	Part n° Referencia	€
1/2" BSP	12.5	3	M (Tipo B)	<b>A807108</b>	<b>14,97</b>
1/2" BSP	12.5	3	M (Tipo A)	<b>A844108</b>	<b>14,97</b>
1/2" NPT	12.5	3	M (Tipo A)	<b>A806108</b>	<b>14,97</b>

## E.R. ISO A Paso total BSP

ISO A Quick release coupling free flow BSP

Coupleur rapide à clapet ISO A pass.total BSP

innesto rapido ISO A passaggio libero BSP

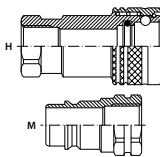

THREAD ROSCA	ISO SIZE TAMAÑO ISO	BG SIZE TAMAÑO BG	C. E.	Part n° Referencia	€
1/4" BSP	6.3	1	M	<b>A831104</b>	<b>3,05</b>
3/8" BSP	10	2	M	<b>A831106</b>	<b>4,99</b>
1/2" BSP	12.5	3	M	<b>A831108</b>	<b>5,82</b>
3/4" BSP	20	4	M	<b>A831112</b>	<b>12,48</b>
1" BSP	25	5	M	<b>A831116</b>	<b>29,39</b>
1"1/4 BSP	31.5	6	M	<b>A831120</b>	<b>61,01</b>
1/4" BSP	6.3	1	F	<b>A831204</b>	<b>11,09</b>
3/8" BSP	10	2	F	<b>A831206</b>	<b>13,20</b>
1/2" BSP	12.5	3	F	<b>A831208</b>	<b>18,86</b>
3/4" BSP	20	4	F	<b>A831212</b>	<b>31,33</b>
1" BSP	25	5	F	<b>A831216</b>	<b>60,45</b>
1"1/4 BSP	31.5	6	F	<b>A831220</b>	<b>133,10</b>

## E.R. Punzón ISO A (rosca NPT)

ISO A NPT Quick release coupling

Coupleur rapide à clapet norme ISO A filetage NPT

Innesto rapido a valvola ISO A NPT

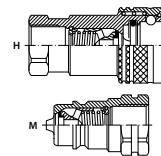

THREAD ROSCA	ISO SIZE TAMAÑO ISO	BG SIZE TAMAÑO BG	C. E.	Part n° Referencia	€
1/4" NPT	6.3	1	M	<b>A801104</b>	<b>6,38</b>
3/8" NPT	10	2	M	<b>A801106</b>	<b>6,71</b>
1/2" NPT	12.5	3	M	<b>A801108</b>	<b>7,43</b>
3/4" NPT	20	4	M	<b>A801112</b>	<b>14,59</b>
1" NPT	25	5	M	<b>A801116</b>	<b>34,39</b>
1"1/4 NPT	31.5	6	M	<b>A801120</b>	<b>83,19</b>
1"1/2 NPT	40	7	M	<b>A801124</b>	<b>115,91</b>
2" NPT	50	8	M	<b>A801132</b>	<b>197,43</b>
1/4" NPT	6.3	1	F	<b>A801204</b>	<b>13,31</b>
3/8" NPT	10	2	F	<b>A801206</b>	<b>14,97</b>
1/2" NPT	12.5	3	F	<b>A801208</b>	<b>19,41</b>
3/4" NPT	20	4	F	<b>A801212</b>	<b>31,61</b>
1" NPT	25	5	F	<b>A801216</b>	<b>63,78</b>
1"1/4 NPT	31.5	6	F	<b>A801220</b>	<b>186,90</b>
1"1/2 NPT	40	7	F	<b>A801224</b>	<b>252,89</b>
2" NPT	50	8	F	<b>A801232</b>	<b>547,38</b>

## E.R. Punzón ISO A (rosca UNF)

ISO A UNF Quick release coupling

Coupleur rapide à clapet norme ISO A filetage UNF

Innesto rapido a valvola ISO B UNF

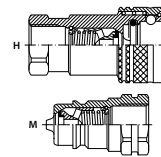

THREAD ROSCA	ISO SIZE TAMAÑO ISO	BG SIZE TAMAÑO BG	C. E.	Part n° Referencia	€
3/4" UNF	12.5	3	M	<b>A803112</b>	<b>7,21</b>
3/4" UNF	12.5	3	F	<b>A803212</b>	<b>19,41</b>

## E.R. Punzón ISO B (rosca BSP)

ISO B Quick release coupling (BSP)

Coupleur rapide à clapet norme ISO B (BSP)

Innesto rapido a valvola ISO B (BSP)

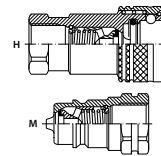

THREAD ROSCA	ISO SIZE TAMAÑO ISO	BG SIZE TAMAÑO BG	C. E.	Part n° Referencia	€
1/8" BSP	5	0	M	<b>A810102</b>	<b>7,21</b>
1/4" BSP	6.3	1	M	<b>A810104</b>	<b>7,21</b>
3/8" BSP	10	2	M	<b>A810106</b>	<b>6,77</b>
1/2" BSP	12.5	3	M	<b>A810108</b>	<b>8,54</b>
3/4" BSP	20	4	M	<b>A810112</b>	<b>17,19</b>
1" BSP	25	5	M	<b>A810116</b>	<b>39,71</b>
1"1/4 BSP	40	7	M	<b>A810120</b>	<b>183,01</b>
1"1/2 BSP	40	7	M	<b>A810124</b>	<b>183,01</b>
2" BSP	50	8	M	<b>A810132</b>	<b>499,13</b>
1/8" BSP	5	0	F	<b>A810202</b>	<b>16,36</b>
1/4" BSP	6.3	1	F	<b>A810204</b>	<b>16,08</b>
3/8" BSP	10	2	F	<b>A810206</b>	<b>18,58</b>
1/2" BSP	12.5	3	F	<b>A810208</b>	<b>28,84</b>
3/4" BSP	20	4	F	<b>A810212</b>	<b>54,46</b>
1" BSP	25	5	F	<b>A810216</b>	<b>92,06</b>
1"1/4 BSP	40	7	F	<b>A810220</b>	<b>246,79</b>
1"1/2 BSP	40	7	F	<b>A810224</b>	<b>248,45</b>
2" BSP	50	8	F	<b>A810232</b>	<b>704,32</b>

# Enchufes rápidos DNP

DNP Quick-release couplings  
Coupleurs rapides DNP  
Innesti rapidi DNP

## E.R. Punzón ISO B (rosca NPT)

ISO B NPT Quick release couplings

Coupleur rapide à clapet norme ISO B NPT

Innesto rapido a valvola ISO B NPT

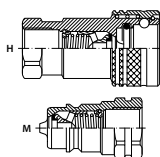

THREAD ROSCA	ISO SIZE TAMAÑO ISO	BG SIZE TAMAÑO BG	C. E.	Part n° Referencia	€
1/8" NPT	5	0	M	<b>A810302</b>	<b>6,66</b>
1/4" NPT	6.3	1	M	<b>A810304</b>	<b>7,21</b>
3/8" NPT	10	2	M	<b>A810306</b>	<b>6,77</b>
1/2" NPT	12.5	3	M	<b>A810308</b>	<b>8,54</b>
3/4" NPT	20	4	M	<b>A810312</b>	<b>17,19</b>
1" NPT	25	5	M	<b>A810316</b>	<b>39,71</b>
1"1/4 NPT	40	7	M	<b>A810320</b>	<b>183,01</b>
1"1/2 NPT	40	7	M	<b>A810324</b>	<b>183,01</b>
2" NPT	50	8	M	<b>A810332</b>	<b>488,04</b>
1/8" NPT	5	0	F	<b>A810402</b>	<b>15,25</b>
1/4" NPT	6.3	1	F	<b>A810404</b>	<b>16,08</b>
3/8" NPT	10	2	F	<b>A810406</b>	<b>18,58</b>
1/2" NPT	12.5	3	F	<b>A810408</b>	<b>28,84</b>
3/4" NPT	20	4	F	<b>A810412</b>	<b>54,46</b>
1" NPT	25	5	F	<b>A810416</b>	<b>92,06</b>
1"1/4 NPT	40	7	F	<b>A810420</b>	<b>249,56</b>
1"1/2 NPT	40	7	F	<b>A810424</b>	<b>249,56</b>
2" NPT	50	8	F	<b>A810432</b>	<b>704,32</b>

## E.R. Punzón Serie NV (rosca BSP)

Quick release coupling NV serie

Coupleur rapide à clapet serie NV

Innesto rapido valvola Serie NV

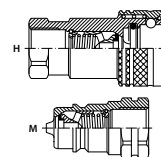

THREAD ROSCA	ISO SIZE TAMAÑO ISO	BG SIZE TAMAÑO BG	C. E.	Part n° Referencia	€
1/4" BSP	6.3	1	M	<b>A820104</b>	<b>6,27</b>
3/8" BSP	10	2	M	<b>A820106</b>	<b>6,88</b>
3/4" BSP	19	4	M	<b>A820112</b>	<b>15,53</b>
1" BSP	25	5	M	<b>A820116</b>	<b>37,71</b>
1"1/4 BSP	31.5	6	M	<b>A820120</b>	<b>81,52</b>
1"1/2 BSP	40	7	M	<b>A820124</b>	<b>115,63</b>
2" BSP	50	8	M	<b>A820132</b>	<b>368,80</b>
1/4" BSP	6.3	1	F	<b>A820204</b>	<b>14,97</b>
3/8" BSP	10	2	F	<b>A820206</b>	<b>17,30</b>
3/4" BSP	19	4	F	<b>A820212</b>	<b>38,82</b>
1" BSP	25	5	F	<b>A820216</b>	<b>72,10</b>
1"1/4 BSP	31.5	6	F	<b>A820220</b>	<b>177,47</b>
1"1/2 BSP	40	7	F	<b>A820224</b>	<b>232,93</b>
2" BSP	50	8	F	<b>A820232</b>	<b>626,68</b>

## E.R. Punzón Serie NV (rosca NPT)

NPT Quick release couplings NV1 serie

Coupleur rapide à clapet serie NV 1 NPT

Innesto rapido a valvola serie NV 1 NPT

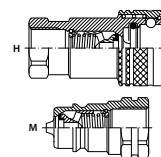

THREAD ROSCA	ISO SIZE TAMAÑO ISO	BG SIZE TAMAÑO BG	C. E.	Part n° Referencia	€
1/4" NPT	6.3	1	M	<b>A821104</b>	<b>7,10</b>
3/8" NPT	10	2	M	<b>A821106</b>	<b>7,10</b>
3/4" NPT	19	4	M	<b>A821112</b>	<b>17,19</b>
1" NPT	25	5	M	<b>A821116</b>	<b>40,21</b>
1"1/4 NPT	31.5	6	M	<b>A821120</b>	<b>81,52</b>
1"1/2 NPT	40	7	M	<b>A821124</b>	<b>115,63</b>
2" NPT	50	8	M	<b>A821132</b>	<b>368,80</b>
1/4" NPT	6.3	1	F	<b>A821204</b>	<b>15,25</b>
3/8" NPT	10	2	F	<b>A821206</b>	<b>17,36</b>
3/4" NPT	19	4	F	<b>A821212</b>	<b>42,15</b>
1" NPT	25	5	F	<b>A821216</b>	<b>72,10</b>
1"1/4 NPT	31.5	6	F	<b>A821220</b>	<b>177,75</b>
1"1/2 NPT	40	7	F	<b>A821224</b>	<b>236,25</b>
2" NPT	50	8	F	<b>A821232</b>	<b>626,68</b>

# Enchufes rápidos DNP

DNP Quick-release couplings  
Coupleurs rapides DNP  
Innesti rapidi DNP

## E.R. Push-Pull Punzón ISO A

Push-Pull quick release ISO A

Coupleurs Push-Pull ISO A

Innesto rapido a valvola ISO A

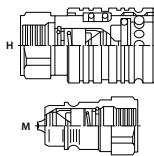

THREAD ROSCA	ISO SIZE TAMAÑO ISO	BG SIZE TAMAÑO BG	C. E.	Part nº Referencia	€
1/2" BSP	12.5	3	M	<b>A840108</b>	<b>7,21</b>
1/2" BSP	12.5	3	F	<b>A840208</b>	<b>20,67</b>
1/2" NPT	12.5	3	F	<b>A841208</b>	<b>20,67</b>
M22X1.5	12.5	3	F	<b>A842222</b>	<b>20,67</b>
3/4" UNF	12.5	3	F	<b>A843234</b>	<b>20,67</b>

## E.R. Push-Pull bola ISO A

Push-Pull coupling ball type ISO A

Coupleurs Push-Pull à bille ISO A

Innesto rapido a sfera ISO A

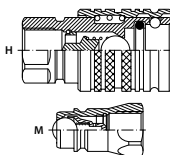

THREAD ROSCA	ISO SIZE TAMAÑO ISO	BG SIZE TAMAÑO BG	C. E.	Part nº Referencia	€
1/2" BSP	12.5	3	M	<b>A704108</b>	<b>9,76</b>
1/2" NPT	12.5	3	M	<b>A705108</b>	<b>9,76</b>
1/2" BSP	12.5	3	F	<b>A740208</b>	<b>22,13</b>
1/2" NPT	12.5	3	F	<b>A741208</b>	<b>22,13</b>
3/4" UNF	12.5	3	F	<b>A702212</b>	<b>22,13</b>

## E.R. Push-Pull Punzón aplic.agric. BSP ISO A

Push-Pull quick release coupling agric.application BSP ISO A

Coupleurs Push-Pull à clapet application agricole BSP ISO A

Innesto rapido a valvola applicazioni agricole BSP ISO A

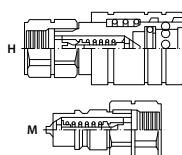

THREAD ROSCA	ISO SIZE TAMAÑO ISO	BG SIZE TAMAÑO BG	C. E.	Part nº Referencia	€
1/4" BSP	6.3	1	M	<b>A895104</b>	<b>28,40</b>
3/8" BSP	10	2	M	<b>A895106</b>	<b>11,65</b>
1/2" BSP	12.5	3	M	<b>A895108</b>	<b>9,15</b>
3/4" BSP	19	4	M	<b>A895112</b>	<b>31,06</b>
1" BSP	25	5	M	<b>A895116</b>	<b>38,27</b>
1/4" BSP	6.3	1	F	<b>A895204</b>	<b>64,22</b>
3/8" BSP	10	2	F	<b>A895206</b>	<b>23,29</b>
1/2" BSP	12.5	3	F	<b>A895208</b>	<b>20,80</b>
3/4" BSP	19	4	F	<b>A895212</b>	<b>95,94</b>
1" BSP	25	5	F	<b>A895216</b>	<b>94,28</b>

## E.R. Push-Pull Punzón aplic. agric. SAE ISO A

Push-Pull quick release coupling agric.application SAE ISO A

Coupleurs Push-Pull à clapet application agricole SAE ISO A

Innesto rapido a valvola applicazioni agricole SAE ISO A

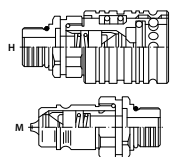

THREAD ROSCA	ISO SIZE TAMAÑO ISO	BG SIZE TAMAÑO BG	C. E.	Part nº Referencia	€
3/4" SAE	12.5	3	M	<b>A845112</b>	<b>10,54</b>
3/4" SAE	12.5	3	F	<b>A845212</b>	<b>24,51</b>

## E.R. Push-Pull Punzón aplic. agric. M mét. ISO A

Push-Pull quick release coupling agric.application Met. M ISO A

Coupleurs Push-Pull à clapet application agricole M mét. ISO A

Innesto rapido a valvola applicazioni agricole M Met ISO A

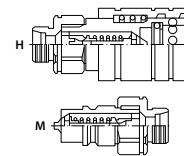

THREAD ROSCA	ISO SIZE TAMAÑO ISO	BG SIZE TAMAÑO BG	C. E.	Part nº Referencia	€
M14X1.5-8L	10	2	M	<b>A89111408</b>	<b>12,20</b>
M16X1.5-10L	10	2	M	<b>A89111610</b>	<b>11,65</b>
M18X1.5-12L	12.5	3	M	<b>A89111812</b>	<b>9,10</b>
M20X1.5-12S	12.5	3	M	<b>A89112012</b>	<b>9,04</b>
M22X1.5-15L	12.5	3	M	<b>A89112215</b>	<b>9,21</b>
M26X1.5-18L	19	4	M	<b>A89112618</b>	<b>31,06</b>
M30X2-22L	19	4	M	<b>A89113022</b>	<b>31,06</b>
M14X1.5-8L	10	2	F	<b>A89121408</b>	<b>23,29</b>
M16X1.5-10L	10	2	F	<b>A89121610</b>	<b>23,29</b>
M18X1.5-12L	12.5	3	F	<b>A89121812</b>	<b>20,41</b>
M20X1.5-12S	12.5	3	F	<b>A89122012</b>	<b>20,41</b>
M22X1.5-15L	12.5	3	F	<b>A89122215</b>	<b>20,41</b>
M26X1.5-18L	19	4	F	<b>A89122618</b>	<b>99,27</b>
M30X2-22L	19	4	F	<b>A89123022</b>	<b>99,27</b>

## E.R. Push-Pull Punzón aplic. agric. M mét. pasat ISO A

Push-Pull quick release coupling agric.application Met. M bulkhead ISO A

Coupleurs Push-Pull à clapet application agricole M mét. passe-doisson ISO A

Innesto rapido a valvola applicazioni agricole M Met. pasaparte ISO A

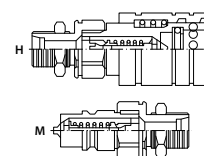

THREAD ROSCA	ISO SIZE TAMAÑO ISO	BG SIZE TAMAÑO BG	C. E.	Part nº Referencia	€
M16X1.5-10L	10	2	M	<b>A89011610</b>	<b>12,20</b>
M18X1.5-12L	12.5	3	M	<b>A89011812</b>	<b>11,42</b>
M22X1.5-15L	12.5	3	M	<b>A89012215</b>	<b>11,42</b>
M16X1.5-10L	10	2	F	<b>A89021610</b>	<b>23,57</b>
M18X1.5-12L	12.5	3	F	<b>A89021812</b>	<b>22,74</b>
M22X1.5-15L	12.5	3	F	<b>A89022215</b>	<b>22,91</b>

## E.R. Push-Pull Punzón acoplamiento en presión ISO A

Push-Pull quick release coupling u/ pressure ISO A

Coupleurs Push-Pull à clapet pression ISO A

Innesto rapido a valvola in pressione ISO A

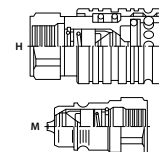

THREAD ROSCA	ISO SIZE TAMAÑO ISO	BG SIZE TAMAÑO BG	C. E.	Part nº Referencia	€
1/2" BSP	12.5	3	M	<b>A8461108</b>	<b>17,19</b>
1/2" NPT	12.5	3	M	<b>A8462108</b>	<b>17,19</b>
M22X1.5	12.5	3	M	<b>A8463122</b>	<b>16,64</b>
3/4" UNF	12.5	3	M	<b>A8464134</b>	<b>23,85</b>
1/2" BSP	12.5	3	F	<b>A8461208</b>	<b>30,50</b>
1/2" NPT	12.5	3	F	<b>A8462208</b>	<b>30,50</b>
M22X1.5	12.5	3	F	<b>A8463222</b>	<b>29,67</b>
3/4" UNF	12.5	3	F	<b>A8464234</b>	<b>37,16</b>

# Enchufes rápidos DNP

DNP Quick-release couplings  
Coupleurs rapides DNP  
Innesti rapidi DNP

## E.R. Bola Serie NS (rosca BSP)

BSP Quick release coupling ball type NS Serie

Coupleur rapide à bille série NS

Innesto rapido a sfera BSP Serie NS

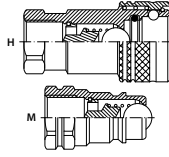

THREAD ROSCA	ISO SIZE TAMAÑO ISO	BG SIZE TAMAÑO BG	C. E.	Part nº Referencia	€
1/4" BSP	6.3	1	M	<b>A700104</b>	<b>6,66</b>
3/8" BSP	10	2	M	<b>A700106</b>	<b>8,43</b>
1/2" BSP	12.5	3	M	<b>A700108</b>	<b>9,43</b>
3/4" BSP	19	4	M	<b>A700112</b>	<b>19,02</b>
1" BSP	25	5	M	<b>A700116</b>	<b>44,64</b>
1/4" BSP	6.3	1	F	<b>A700204</b>	<b>13,42</b>
3/8" BSP	10	2	F	<b>A700206</b>	<b>18,58</b>
1/2" BSP	12.5	3	F	<b>A700208</b>	<b>21,52</b>
3/4" BSP	19	4	F	<b>A700212</b>	<b>42,70</b>
1" BSP	25	5	F	<b>A700216</b>	<b>79,58</b>

## E.R. Bola Serie NS (rosca UNF)

UNF Quick release coupling ball type NS Serie

Coupleur rapide à bille filetage UNF série NS

Innesto rapido a sfera UNF serie NS

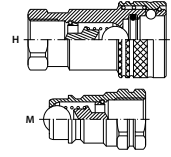

THREAD ROSCA	ISO SIZE TAMAÑO ISO	BG SIZE TAMAÑO BG	C. E.	Part nº Referencia	€
3/4" UNF	12.5	3	M	<b>A703112</b>	<b>9,93</b>
3/4" UNF	12.5	3	F	<b>A703212</b>	<b>21,63</b>

## E.R. Bola Tipo Taz (gondolas y semirem.) BSP

Quick release coupling ball type Type Taz (gondolas and semi-tows) BSP

Coupleur rapide à bille Type Taz spécial carrocieres BSP

Innesto rapido a sfera tipo Taz per semirimorchio BSP

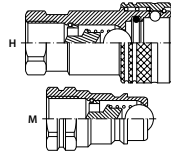

THREAD ROSCA	ISO SIZE TAMAÑO ISO	C. E.	Part nº Referencia	€
3/4" BSP	19	M	<b>A700112TAZ</b>	<b>15,59</b>
1" BSP	25	M	<b>A700116TAZ</b>	<b>23,59</b>
3/4" BSP	19	F	<b>A700212TAZ</b>	<b>36,40</b>
1" BSP	25	F	<b>A700216TAZ</b>	<b>55,04</b>

## E.R. Bola Serie NS (rosca NPT)

NPT Quick release coupling ball type NS Serie

Coupleur rapide à bille filetage NPT série NS

Innesto rapido a sfera NPT serie NS

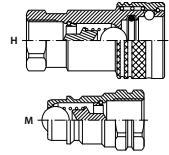

THREAD ROSCA	ISO SIZE TAMAÑO ISO	BG SIZE TAMAÑO BG	C. E.	Part nº Referencia	€
1/4" NPT	6.3	1	M	<b>A701104</b>	<b>6,66</b>
3/8" NPT	10	2	M	<b>A701106</b>	<b>8,43</b>
1/2" NPT	12.5	3	M	<b>A701108</b>	<b>9,43</b>
3/4" NPT	19	4	M	<b>A701112</b>	<b>19,02</b>
1" NPT	25	5	M	<b>A701116</b>	<b>44,64</b>
1/4" NPT	6.3	1	F	<b>A701204</b>	<b>13,42</b>
3/8" NPT	10	2	F	<b>A701206</b>	<b>18,58</b>
1/2" NPT	12.5	3	F	<b>A701208</b>	<b>21,52</b>
3/4" NPT	19	4	F	<b>A701212</b>	<b>42,70</b>
1" NPT	25	5	F	<b>A701216</b>	<b>79,58</b>

## E.R. Válvula plana altísima presión 700 bar

Flat face quick release coupling inner threads high pressure 700 bar

Coupleur rapide à clapet face plane (marteau) haute pression 700 bar

Innesto rapido faccia piana altissima presione 700 bar

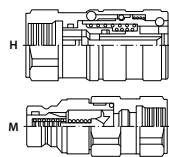

THREAD ROSCA	ISO SIZE TAMAÑO ISO	BG SIZE TAMAÑO BG	C. E.	Part nº Referencia	€
1/4" BSP	6.3	1	M	<b>A903104</b>	<b>38,27</b>
3/8" BSP	6.3	1	M	<b>A903106</b>	<b>56,29</b>
1/4" BSP	6.3	1	F	<b>A903204</b>	<b>69,32</b>
3/8" BSP	6.3	1	F	<b>A903206</b>	<b>119,24</b>

## E.R. Bola altísima presión 700 bar

Quick release coupling ball type very high pressure (700 bar)

Coupleur rapide à verrouillage vissé haute pression-700 bar

Innesto rapido a sfera 700 bar

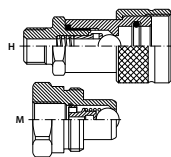

THREAD ROSCA	ISO SIZE TAMAÑO ISO	BG SIZE TAMAÑO BG	C. E.	Part nº Referencia	€
3/8" BSP	10	2	M	<b>A706106</b>	<b>12,20</b>
1/4" NPT	6.3	1	M	<b>A711104</b>	<b>12,26</b>
3/8" NPT	10	2	M	<b>A711106</b>	<b>12,20</b>
3/8" BSP	10	2	F	<b>A706206</b>	<b>30,50</b>
1/4" NPT	6.3	1	F	<b>A711204</b>	<b>18,63</b>
3/8" NPT	10	2	F	<b>A711206</b>	<b>18,23</b>

## Enchufes altísima presión 1500 bar BSP

Couplings 1500 bar BSP

Coupleurs 1500 bar BSP

Innesti 1500 bar BSP

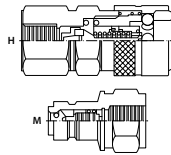

THREAD ROSCA	ISO SIZE TAMAÑO ISO	BG SIZE TAMAÑO BG	C. E.	Part nº Referencia	€
1/4" BSP	6.3	1	M	<b>A920104</b>	<b>46,59</b>
1/4" BSP	6.3	1	F	<b>A920204</b>	<b>120,90</b>

# Enchufes rápidos DNP

DNP Quick-release couplings  
Coupleurs rapides DNP  
Innesti rapidi DNP

## Válvula de frenado macho

Male brake valve

Valve freinage mâle

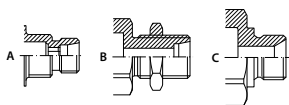

Valvola di frenaggio maschio

THREAD ROSCA	ISO SIZE TAMAÑO ISO	BG SIZE TAMAÑO BG	C. E.	Part nº Referencia	€
1/2" BSP	-	12.5	3	M (Type C) <b>A910508</b>	<b>15,53</b>
M18X1,5	-	12.5	3	M (Type B) <b>A912118</b>	<b>16,69</b>
M20X1,5	-	12.5	3	M (Type B) <b>A912120</b>	<b>17,03</b>
M22X1,5	-	12.5	3	M (Type B) <b>A912122</b>	<b>17,30</b>
M16x1,5	M20x1,5	12.5	3	M (Type A) <b>A912316</b>	<b>17,47</b>
M18x1,5	M20x1,5	12.5	3	M (Type A) <b>A912318</b>	<b>17,47</b>

## Válvula de frenado hembra

Female brake valve

Valve freinage femelle

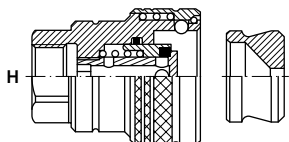

Valvola di frenaggio femmina

THREAD ROSCA	ISO SIZE TAMAÑO ISO	BG SIZE TAMAÑO BG	C. E.	Part nº Referencia	€
3/8" BSP	12.5	3	F	<b>A910206</b>	<b>30,95</b>
1/2" BSP	12.5	3	F	<b>A910208</b>	<b>30,28</b>
M18X1.5	12.5	3	F	<b>A910218</b>	<b>31,50</b>

## E.R. Puzón ISO B (rosca BSP) latón

ISO B Quick release coupling brass

Coupleur rapide à clapet norme ISO B laiton

Innesto rapido a valvola ISO B ottone

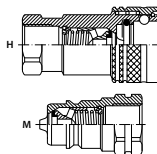

THREAD ROSCA	ISO SIZE TAMAÑO ISO	BG SIZE TAMAÑO BG	C. E.	Part nº Referencia	€
1/4" BSP	6.3	1	M	<b>A850104</b>	<b>12,20</b>
3/8" BSP	10	2	M	<b>A850106</b>	<b>15,53</b>
1/2" BSP	12.5	3	M	<b>A850108</b>	<b>21,63</b>
3/4" BSP	19	4	M	<b>A850112</b>	<b>38,82</b>
1" BSP	25	5	M	<b>A850116</b>	<b>69,88</b>
1"1/4 BSP	40	7	M	<b>A850120</b>	<b>388,21</b>
1"1/2 BSP	40	7	M	<b>A850124</b>	<b>388,21</b>
2" BSP	50	8	M	<b>A850132</b>	<b>909,52</b>
1/4" BSP	6.3	1	F	<b>A850204</b>	<b>31,06</b>
3/8" BSP	10	2	F	<b>A850206</b>	<b>44,37</b>
1/2" BSP	12.5	3	F	<b>A850208</b>	<b>72,10</b>
3/4" BSP	19	4	F	<b>A850212</b>	<b>124,78</b>
1" BSP	25	5	F	<b>A850216</b>	<b>184,68</b>
1"1/4 BSP	40	7	F	<b>A850220</b>	<b>510,22</b>
1"1/2 BSP	40	7	F	<b>A850224</b>	<b>510,22</b>
2" BSP	50	8	F	<b>A850232</b>	<b>1.425,29</b>

## Válvula agrícola macho acoplamiento en presión

Male agricultural valve

Valve agricole à visser mâle

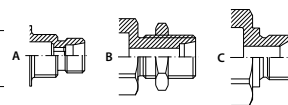

Valvola agricola maschio

THREAD ROSCA	ISO SIZE TAMAÑO ISO	BG SIZE TAMAÑO BG	C. E.	Part nº Referencia	€	
1/2" BSP	-	M36x2	12.5	3	M (Type C) <b>A950108</b>	<b>16,31</b>
M18x1,5	-	M36x2	12.5	3	M (Type B) <b>A950118</b>	<b>18,08</b>
M20x1,5	-	M36x2	12.5	3	M (Type B) <b>A950120</b>	<b>18,08</b>
M22x1,5	-	M36x2	12.5	3	M (Type B) <b>A950122</b>	<b>18,08</b>
M16x1,5	M20x1,5	M36x2	12.5	3	M (Type A) <b>A9141620</b>	<b>18,41</b>
M18x1,5	M20x1,5	M36x2	12.5	3	M (Type A) <b>A9141820</b>	<b>18,41</b>

## Válvula agrícola hembra acoplamiento en presión

Female agricultural valve

Valve agricole à visser femelle

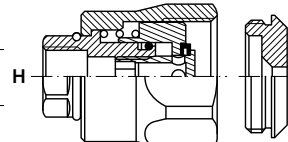

Valvola agricola femmina

THREAD ROSCA	ISO SIZE TAMAÑO ISO	BG SIZE TAMAÑO BG	C. E.	Part nº Referencia	€
M18X1.5	M36x2	12.5	3	F <b>A950218</b>	<b>27,40</b>

## Arandelas PTFE

PTFE seals

Rondelles PTFE

Rondelle a PTFE



ISO SIZE TAMAÑO ISO	BG SIZE TAMAÑO BG	Part nº Referencia	€
6.3	1	<b>PTFEA04</b>	<b>0,78</b>
10	2	<b>PTFEA06</b>	<b>0,91</b>
12.5	3	<b>PTFEA08</b>	<b>0,97</b>
19	4	<b>PTFEA12</b>	<b>1,62</b>
25	5	<b>PTFEA16</b>	<b>1,62</b>

## Juego de juntas de reparación e.r. ISO A

Kit of seals to repair for ISO A quick release coupling

Jeu de joints pour coupleur ISO A



Guarnizioni per innesto ISO A

Ø INT.	THICK. ESPESES.	ISO SIZE TAMAÑO ISO	BG SIZE TAMAÑO BG	Part nº Referencia	€
11.91	2.62	6.3	1	<b>NBRA04</b>	<b>0,45</b>
17.12	2.62	10	2	<b>NBRA06</b>	<b>0,58</b>
20.24	2.62	12.5	3	<b>NBRA08</b>	<b>0,71</b>
28.24	2.62	19	4	<b>NBRA12</b>	<b>0,78</b>
34.59	2.62	25	5	<b>NBRA16</b>	<b>0,84</b>

# Enchufes rápidos DNP

DNP Quick-release couplings  
Coupleurs rapides DNP  
Innesti rapidi DNP

## Tapones para enchufes rápidos ISO A

Plugs and caps for ISO A quick release couplings

Bouchons et capuchons de plastique pour coupleurs norme ISO A



Tappi per ISO A

ISO SIZE TAMAÑO ISO	BG SIZE TAMAÑO BG	DESCRIPTION DESCRIPCIÓN	C. E.	Part nº Referencia	€
6,3	1	Male plug for female coupling	F	<b>A990104</b>	<b>1,89</b>
10	2	Male plug for female coupling	F	<b>A990106</b>	<b>1,89</b>
12,5	3	Male plug for female coupling	F	<b>A990108</b>	<b>1,55</b>
19	4	Male plug for female coupling	F	<b>A990112</b>	<b>3,49</b>
25	5	Male plug for female coupling	F	<b>A990116</b>	<b>5,82</b>
6,3	1	Cap for male coupling	M	<b>A990204</b>	<b>1,89</b>
10	2	Cap for male coupling	M	<b>A990206</b>	<b>1,89</b>
12,5	3	Cap for male coupling	M	<b>A990208</b>	<b>1,55</b>
19	4	Cap for male coupling	M	<b>A990212</b>	<b>3,49</b>
25	5	Cap for male coupling	M	<b>A990216</b>	<b>5,82</b>

## Tapones para enchufes ISO B

Plugs and caps for ISO B quick release coupling

Bouchons et capuchons de plastique pour coupleurs ISO B



Tappi per ISO B

ISO SIZE TAMAÑO ISO	BG SIZE TAMAÑO BG	DESCRIPTION DESCRIPCIÓN	C. E.	Part nº Referencia	€
6,3	1	Male plug for female coupling	F	<b>A991104</b>	<b>2,97</b>
10	2	Male plug for female coupling	F	<b>A991106</b>	<b>2,97</b>
12,5	3	Male plug for female coupling	F	<b>A991108</b>	<b>3,25</b>
19	4	Male plug for female coupling	F	<b>A991112</b>	<b>3,53</b>
25	5	Male plug for female coupling	F	<b>A991116</b>	<b>4,95</b>
6,3	1	Cap for male coupling	M	<b>A991204</b>	<b>2,97</b>
10	2	Cap for male coupling	M	<b>A991206</b>	<b>2,97</b>
12,5	3	Cap for male coupling	M	<b>A991208</b>	<b>3,25</b>
19	4	Cap for male coupling	M	<b>A991212</b>	<b>3,53</b>
25	5	Cap for male coupling	M	<b>A991216</b>	<b>4,95</b>

## Tapones para enchufes de válvula plana ISO 16028

Plugs and caps for flat face quick release couplings ISO 16028

Bouchons et capuchons de plastique pour coupleurs face plane ISO 16028



Tappi per innesti a faccia piana ISO 16028

ISO SIZE TAMAÑO ISO	BG SIZE TAMAÑO BG	DESCRIPTION DESCRIPCIÓN	C. E.	Part nº Referencia	€
6,3	1	Male plug for female coupling	H	<b>A993104</b>	<b>3,71</b>
10	2	Male plug for female coupling	H	<b>A993106</b>	<b>2,97</b>
10	2	Male plug for female coupling	H	<b>A993108</b>	<b>2,97</b>
19	3	Male plug for female coupling	H	<b>A993112</b>	<b>3,77</b>
25	4	Male plug for female coupling	H	<b>A993116</b>	<b>5,23</b>
30	5	Male plug for female coupling	H	<b>A993120</b>	<b>7,07</b>
6,3	1	Cap for male coupling	M	<b>A993204</b>	<b>3,75</b>
10	2	Cap for male coupling	M	<b>A993206</b>	<b>2,97</b>
12,5	2	Cap for male coupling	M	<b>A993208</b>	<b>2,97</b>
19	3	Cap for male coupling	M	<b>A993212</b>	<b>3,77</b>
25	4	Cap for male coupling	M	<b>A993216</b>	<b>4,95</b>
30	5	Cap for male coupling	M	<b>A993220</b>	<b>7,07</b>

## Tapones para enchufes autorroscantes ISO 14541

Plugs and caps for quick release screw coupling ISO 14541

Bouchon pour coupleur rapide à visser ISO 14541



Tappi per innesti rapidi a vite ISO 14541

ISO SIZE TAMAÑO ISO	BG SIZE TAMAÑO BG	DESCRIPTION DESCRIPCIÓN	C. E.	Part nº Referencia	€
6,3	1	Male plug for female coupling	F	<b>A994104</b>	<b>5,55</b>
10	2	Male plug for female coupling	F	<b>A994106</b>	<b>5,55</b>
12,5	3	Male plug for female coupling	F	<b>A994108</b>	<b>4,99</b>
19	4	Male plug for female coupling	F	<b>A994112</b>	<b>6,43</b>
25	5	Male plug for female coupling	F	<b>A994116</b>	<b>5,55</b>
6,3	1	Cap for male coupling	M	<b>A994204</b>	<b>5,55</b>
10	2	Cap for male coupling	M	<b>A994206</b>	<b>5,55</b>
12,5	3	Cap for male coupling	M	<b>A994208</b>	<b>5,82</b>
19	4	Cap for male coupling	M	<b>A994212</b>	<b>6,43</b>
25	5	Cap for male coupling	M	<b>A994216</b>	<b>5,55</b>

## Tapones para enchufes altísima presión ISO 14540

Plugs and caps for quick release coupling very high pressure ISO 14540

Bouchon pour coupleur rapide très haute pression ISO 14540



Tappi per innesti rapidi alta pressione ISO 14540

ISO SIZE TAMAÑO ISO	BG SIZE TAMAÑO BG	Part nº Referencia	€
10	2	<b>A992106</b>	<b>7,21</b>

## Tapones para enchufes NV

Plugs and caps for NV quick release coupling

Bouchons et capuchons de plastique pour coupleurs NV



Tappi per ISO NV

ISO SIZE TAMAÑO ISO	BG SIZE TAMAÑO BG	DESCRIPTION DESCRIPCIÓN	Part nº Referencia	€
6,3	1	Male plug for female coupling	<b>A995104</b>	<b>2,50</b>
10	2	Male plug for female coupling	<b>A995106</b>	<b>2,50</b>
19	4	Male plug for female coupling	<b>A995112</b>	<b>1,94</b>
25	5	Male plug for female coupling	<b>A995116</b>	<b>1,66</b>
6,3	1	Cap for male coupling	<b>A995204</b>	<b>2,50</b>
10	2	Cap for male coupling	<b>A995206</b>	<b>2,50</b>
19	4	Cap for male coupling	<b>A995212</b>	<b>1,94</b>
25	5	Cap for male coupling	<b>A995216</b>	<b>1,66</b>

# Enchufes rápidos TrΔle

TrΔle quick-release couplings

Coupleurs rapides TrΔle

Innesti rapidi TrΔle

Adaptors

Quick-release couplings

Ball valves

Diverters

Swivel fittings

Multi-way couplings

Protections

## E.R. Punzón ISO A BSP

ISO A Quick release coupling BSP

Coupleur rapide à clapet norme ISO A BSP

Innesto rapido a valvula ISO A BSP

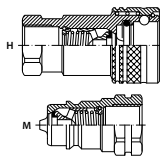

THREAD ROSCA	ISO SIZE TAMAÑO ISO	BG SIZE TAMAÑO BG	C. E.	Part nº Referencia	€
1/4" BSP	6.3	1	M	<b>B800104</b>	<b>4,40</b>
3/8" BSP	10	2	M	<b>B800106</b>	<b>5,03</b>
1/2" BSP	12.5	3	M	<b>B800108</b>	<b>5,84</b>
3/4" BSP	20	4	M	<b>B800112</b>	<b>9,61</b>
1" BSP	25	5	M	<b>B800116</b>	<b>16,34</b>
1/4" BSP	6.3	1	F	<b>B800204</b>	<b>9,43</b>
3/8" BSP	10	2	F	<b>B800206</b>	<b>11,00</b>
1/2" BSP	12.5	3	F	<b>B800208</b>	<b>13,58</b>
3/4" BSP	20	4	F	<b>B800212</b>	<b>22,50</b>
1" BSP	25	5	F	<b>B800216</b>	<b>38,72</b>

## E.R. Punzón ISO B BSP

ISO B Quick release coupling BSP

Coupleur rapide à clapet norme ISO B BSP

Innesto rapido a valvula ISO B BSP

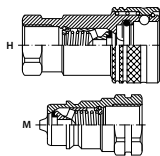

THREAD ROSCA	ISO SIZE TAMAÑO ISO	BG SIZE TAMAÑO BG	C. E.	Part nº Referencia	€
1/4" BSP	06	1	M	<b>B810104</b>	<b>4,84</b>
3/8" BSP	10	2	M	<b>B810106</b>	<b>5,53</b>
1/2" BSP	13	3	M	<b>B810108</b>	<b>6,41</b>
3/4" BSP	19	4	M	<b>B810112</b>	<b>10,62</b>
1" BSP	25	5	M	<b>B810116</b>	<b>16,72</b>
1/4" BSP	06	1	F	<b>B810204</b>	<b>10,37</b>
3/8" BSP	10	2	F	<b>B810206</b>	<b>12,13</b>
1/2" BSP	13	3	F	<b>B810208</b>	<b>14,96</b>
3/4" BSP	19	4	F	<b>B810212</b>	<b>24,76</b>
1" BSP	25	5	F	<b>B810216</b>	<b>38,97</b>

## E.R. Válvula plana Ecológico BSP

Ecological flat face coupling BSP

Coupleur rapide à clapet face plane  
"Ecologique" BSP

Innesto rapido a faccia piana Ecologico BSP

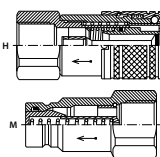

THREAD ROSCA	ISO SIZE TAMAÑO ISO	BG SIZE TAMAÑO BG	C. E.	Part nº Referencia	€
1/4" BSP	06	1	M	<b>B900104</b>	<b>10,12</b>
3/8" BSP	10	2	M	<b>B900106</b>	<b>15,09</b>
1/2" BSP	12	3	M	<b>B900108</b>	<b>22,63</b>
3/4" BSP	-	-	M	<b>B900112</b>	<b>27,66</b>
1" BSP	19	4	M	<b>B900116</b>	<b>42,56</b>
1/4" BSP	06	1	F	<b>B900204</b>	<b>26,34</b>
3/8" BSP	10	2	F	<b>B900206</b>	<b>35,20</b>
1/2" BSP	12	3	F	<b>B900208</b>	<b>46,52</b>
3/4" BSP	-	-	F	<b>B900212</b>	<b>64,42</b>
1" BSP	19	4	F	<b>B900216</b>	<b>99,37</b>

## E.R. Punzón Serie NV BSP

Quick release coupling NV Serie BSP

Coupleur rapide à clapet Serie NV BSP

Innesto rapido a valvula Serie NV BSP

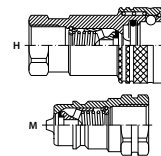

THREAD ROSCA	ISO SIZE TAMAÑO ISO	BG SIZE TAMAÑO BG	C. E.	Part nº Referencia	€
1/4" BSP	6.3	1	M	<b>B820104</b>	<b>4,72</b>
3/8" BSP	10	2	M	<b>B820106</b>	<b>5,41</b>
3/4" BSP	20	4	M	<b>B820112</b>	<b>10,31</b>
1" BSP	25	5	M	<b>B820116</b>	<b>16,28</b>
1/4" BSP	6.3	1	F	<b>B820204</b>	<b>10,12</b>
3/8" BSP	10	2	F	<b>B820206</b>	<b>11,75</b>
3/4" BSP	20	4	F	<b>B820212</b>	<b>24,07</b>
1" BSP	25	5	F	<b>B820216</b>	<b>37,90</b>

## E.R. Punzón ISO A (rosca NPT)

ISO A Quick release coupling NPT

Coupleur rapide à clapet norme ISO A NPT

Innesto rapido a valvula ISO A NPT

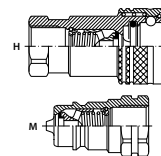

THREAD ROSCA	ISO SIZE TAMAÑO ISO	BG SIZE TAMAÑO BG	C. E.	Part nº Referencia	€
1/4" NPT	6.3	1	M	<b>B801104</b>	<b>4,40</b>
3/8" NPT	10	2	M	<b>B801106</b>	<b>5,03</b>
1/2" NPT	12.5	3	M	<b>B801108</b>	<b>6,17</b>
3/4" NPT	20	4	M	<b>B801112</b>	<b>9,62</b>
1" NPT	25	5	M	<b>B801116</b>	<b>16,34</b>
1/4" NPT	6.3	1	F	<b>B801204</b>	<b>9,43</b>
3/8" NPT	10	2	F	<b>B801206</b>	<b>11,00</b>
1/2" NPT	12.5	3	F	<b>B801208</b>	<b>13,58</b>
3/4" NPT	20	4	F	<b>B801212</b>	<b>22,50</b>
1" NPT	25	5	F	<b>B801216</b>	<b>38,72</b>

## Válvulas de frenado BSP

Brake valves BSP

Valves freinage BSP

Valvole di frenaggio BSP

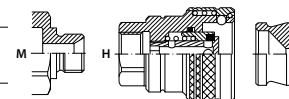

THREAD ROSCA	ISO SIZE TAMAÑO ISO	BG SIZE TAMAÑO BG	C. E.	Part nº Referencia	€
1/2" BSP	10	3	M	<b>B910508</b>	<b>10,18</b>
1/2" BSP	10	3	F	<b>B910208</b>	<b>22,63</b>

# Enchufes rápidos TrΔle

*TrΔle quick-release couplings*

*Coupleurs rapides TrΔle*

*Innesti rapidi TrΔle*

## E.R. Push-Pull Punzón TrΔle BSP

*TrΔle Push-Pull couplings BSP*

*Coupleurs Push-Pull TrΔle BSP*

*Innesti Push-Pull TrΔle BSP*

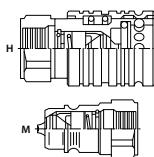

THREAD ROSCA	ISO SIZE TAMAÑO ISO	BG SIZE TAMAÑO BG	C. E.	Part nº Referencia	€
1/2" BSP	12.5	3	M	<b>B840108</b>	<b>5,53</b>
1/2" BSP	12.5	3	H	<b>B840208</b>	<b>15,46</b>

## Tapones para enchufes rápidos ISO A

*Plugs and caps for ISO A quick release couplings*

*Bouchons et capuchons de plastique pour coupleurs norme ISO A*

*Tappi per ISO A*



ISO SIZE TAMAÑO ISO	BG SIZE TAMAÑO BG	DESCRIPTION DESCRIPCIÓN	C. E.	Part nº Referencia	€
6.3	1	Male plug for female coupling	H	<b>B990104</b>	<b>0,50</b>
10	2	Male plug for female coupling	H	<b>B990106</b>	<b>0,64</b>
12.5	3	Male plug for female coupling	H	<b>B990108</b>	<b>1,07</b>
20	4	Male plug for female coupling	H	<b>B990112</b>	<b>1,43</b>
25	5	Male plug for female coupling	H	<b>B990116</b>	<b>1,65</b>
6.3	1	Cap for male coupling	M	<b>B990204</b>	<b>0,50</b>
10	2	Cap for male coupling	M	<b>B990206</b>	<b>0,64</b>
12.5	3	Cap for male coupling	M	<b>B990208</b>	<b>1,07</b>
20	4	Cap for male coupling	M	<b>B990212</b>	<b>1,43</b>
25	5	Cap for male coupling	M	<b>B990216</b>	<b>1,65</b>

## Tapones para enchufes rápidos ISO B

*Plugs and caps for ISO B quick release couplings*

*Bouchons et capuchons de plastique pour coupleurs norme ISO B*

*Tappi per ISO B*



ISO SIZE TAMAÑO ISO	BG SIZE TAMAÑO BG	DESCRIPTION DESCRIPCIÓN	C. E.	Part nº Referencia	€
6.3	1	Male plug for female coupling	H	<b>B991104</b>	<b>0,57</b>
10	2	Male plug for female coupling	H	<b>B991106</b>	<b>0,72</b>
12.5	3	Male plug for female coupling	H	<b>B991108</b>	<b>1,22</b>
20	4	Male plug for female coupling	H	<b>B991112</b>	<b>1,58</b>
25	5	Male plug for female coupling	H	<b>B991116</b>	<b>1,86</b>
6.3	1	Cap for male coupling	M	<b>B991204</b>	<b>0,57</b>
10	2	Cap for male coupling	M	<b>B991206</b>	<b>0,72</b>
12.5	3	Cap for male coupling	M	<b>B991208</b>	<b>1,22</b>
20	4	Cap for male coupling	M	<b>B991212</b>	<b>1,58</b>
25	5	Cap for male coupling	M	<b>B991216</b>	<b>1,86</b>

## Llaves de paso

*Ball valves*

Robinets

*Rubinetti*

### Llaves de paso alta presión

*Ball valves high pressure*  
Robinets haute pression  
*Rubinetti a sfera alta pressione*

333

### Llaves de paso baja presión

*Low pressure Ball valves*  
Robinets Basse pression  
*Rubinetti Bassa pressione*

337

### Llaves de paso alta presión TrΔle

*TrΔle Ball Valves*  
Robinets TrΔle haute pression  
*Rubinetti a sfera TrΔle*

338

3

## Llaves de paso alta presión

Ball valves high pressure  
 Robinets haute pression  
 Rubinetti a sfera alta pressione

- De 2 vías / 2 Ways ball valve / Robinets haute pression 2 voies / Rubinetti a sfera 2 vie

| 333



BKH G

BKH L

BKH S

BKH G NPT

BKH L DN

BKH S DN

BKH G DN

- De 3 vías / 3 Ways ball valve / Robinets haute pression 3 voies / Rubinetti a sfera 3 vie

| 334



BK3 G

3KH G

BK3 GT

BK3 NPT

A600

- De 4 vías / 4 Ways ball valve / Robinets haute pression 4 voies / Rubinetti a sfera 4 vie

| 334



4KH G

- Útil para cierre con candado / Locking devices / Dispositifs de verrouillage / Dispositivi di bloccaggio

| 335



CANDT2

CANDT4

- Llaves especiales y complementos / Special ball valves and accessories / Robinets spéciaux et compléments / Rubinetti speciali e accessori

| 335



A60013/LR

## Llaves de paso baja presión

*Low pressure Ball valves*  
 Robinets Basse pression  
 Rubinetti Bassa pressione

- Llave de esfera baja presión / 2 Ways ball valve low pressure / Robinet basse pression 2 voies boisseau sphérique pn 16/25 / Rubinetto a sfera bassa pressione

337



BP2V

- Llave de esfera baja presión anti-hielo / 2 Ways ball valve low pressure non frozen / Robinet basse pression 2 voies boisseau sphérique pn 25 anti-gel / Rubinetto a sfera, anti-gelo

337



BP2VA

Adaptors

Quick-release couplings

Ball valves

Diverters

Swivel fittings

Multi-way couplings

Protections

# Llaves de paso alta presión TrΔle

*TrΔle Ball Valves*

Robinets TrΔle haute pression

Rubinetti a sfera TrΔle

- De 2 vías / 2 ways / 2 voies / Due vie

| 338



GB2V



GB2V\_NPT



GB2V\_L



GB2V\_S

- De 3 vías / 3 ways / 3 voies / Tre vie

| 338



GB3V



GB3VH

# Llaves de paso alta presión

Ball valves high pressure  
Robinetts haute pression  
Rubinetti a sfera alta pressione

## Llave 2 vías rosca hembra BSP

2 Ways ball valve BSP female

Robinet haute pression 2 voies boisseau sphérique BSP

Rubinetto a sfera femmina-femmina BSP



DN	THREAD ROSCA	Part nº Referencia	€
4	1/8" BSP	<b>BKH G 1/8</b>	<b>42,58</b>
6	1/4" BSP	<b>BKH G 1/4</b>	<b>31,26</b>
10	3/8" BSP	<b>BKH G 3/8</b>	<b>29,05</b>
13	1/2" BSP	<b>BKH G 1/2</b>	<b>32,95</b>
20	3/4" BSP	<b>BKH G 3/4</b>	<b>67,69</b>
25	1" BSP	<b>BKH G 1</b>	<b>76,75</b>
25	1"1/4 BSP	<b>BKH G 1 1/4 DN25</b>	<b>82,23</b>
25	1"1/2 BSP	<b>BKH G 1 1/2 DN25</b>	<b>146,55</b>

Orificios de fijación incluidos desde 1/8" BSP hasta 1" BSP / Fixation holes included from 1/8" BSP to 1" BSP / Trous de fixation inclus depuis 1/8" BSP jusqu'à 1" BSP / Fori di fissaggio inclusi da 1/8" BSP fino a 1" BSP

## Llave 2 vías tubo rígido Serie Ligera

2 Ways ball valve: tube connection Light Series

Robinet haute pression 2 voies boisseau sphérique sortie pour tube rigide DIN Série Légère

Rubinetto a sfera maschio DIN 2353 Serie L



DN	PIPE TUBO	THREAD ROSCA	Part nº Referencia	€
4	6L	M12x1.5	<b>BKH 6 L</b>	<b>39,78</b>
6	8L	M14x1.5	<b>BKH 8 L</b>	<b>30,46</b>
8	10L	M16x1.5	<b>BKH 10 L</b>	<b>31,66</b>
10	12L	M18x1.5	<b>BKH 12 L</b>	<b>36,24</b>
13	15L	M22x1.5	<b>BKH 15 L</b>	<b>35,80</b>
16	18L	M26x1.5	<b>BKH 18 L</b>	<b>47,88</b>
20	22L	M30x2	<b>BKH 22 L</b>	<b>79,61</b>
25	28L	M36x2	<b>BKH 28 L</b>	<b>127,61</b>
25/32	35L	M45X2	<b>BKH 35 L</b>	<b>133,60</b>
25/40	42L	M52x2	<b>BKH 42 L</b>	<b>215,72</b>

## Llave 2 vías tubo rígido Serie Pesada

2 Ways ball valve: tube connection Heavy Series

Robinet haute pression 2 voies boisseau sphérique sortie pour tube rigide din Série Lourde

Rubinetto a sfera maschio DIN Serie S



DN	PIPE TUBO	THREAD ROSCA	Part nº Referencia	€
4	8S	M16x1.5	<b>BKH 8 S</b>	<b>44,16</b>
6	10S	M18x1.5	<b>BKH 10 S</b>	<b>36,97</b>
8	12S	M20x1.5	<b>BKH 12 S</b>	<b>33,75</b>
10	14S	M22x1.5	<b>BKH 14 S</b>	<b>48,73</b>
13	16S	M24x1.5	<b>BKH 16 S</b>	<b>42,03</b>
16	20S	M30x2	<b>BKH 20 S</b>	<b>94,18</b>
13	20S	M30x2	<b>BKH 20 S DN13</b>	<b>56,34</b>
20	25S	M36x2	<b>BKH 25 S</b>	<b>87,71</b>
25	30S	M42x2	<b>BKH 30 S</b>	<b>123,04</b>

## Llave 2 vías rosca hembra NPT

2 Ways ball valve NPT female

Robinet haute pression 2 voies boisseau sphérique sortie femelle briggs (NPT)

Rubinetto a sfera 2 vie femmina NPT



DN	THREAD ROSCA	Part nº Referencia	€
6	1/4" NPT	<b>BKH G 1/4 NPT</b>	<b>47,57</b>
10	3/8" NPT	<b>BKH G 3/8 NPT</b>	<b>55,13</b>
13	1/2" NPT	<b>BKH G 1/2 NPT</b>	<b>59,63</b>
20	3/4" NPT	<b>BKH G 3/4 NPT</b>	<b>104,95</b>
25	1" NPT	<b>BKH G 1 NPT</b>	<b>135,59</b>
25	1"1/4 NPT	<b>BKH G 1 1/4 NPT</b>	<b>181,03</b>
25	1"1/2 NPT	<b>BKH G 1 1/2 NPT</b>	<b>237,79</b>
50	2" NPT	<b>BKH G 2 NPT</b>	<b>481,55</b>

## Llave 2 vías tubo rígido L paso total

Ball-valves: tube connection L serie DIN 2353 full bore

Robinetts haute pression 2 voies boisseau sphérique femelle ISO 228

Rubinetto a sfera maschio DIN 2353 -L-



DN	PIPE TUBO	THREAD ROSCA	Part nº Referencia	€
32	35L	M45X2	<b>BKH 35 L DN32</b>	<b>325,75</b>
40	40L	M52x2	<b>BKH 42 L DN40</b>	<b>430,28</b>

## Llave 2 vías tubo rígido S paso total

Ball-valves: tube connection S serie DIN 2353 full bore

Robinetts haute pression 2 voies boisseau sphérique métrique Série Lourde passage total

Rubinetto a sfera maschio DIN 2353 -S-



DN	PIPE TUBO	THREAD ROSCA	Part nº Referencia	€
32	38S	M52x2	<b>BKH 38 S DN32</b>	<b>330,51</b>

## Llave de paso BSP hembra ISO 228 paso total

Ball-valves BSP female ISO 228

Robinetts haute pression 2 voies boisseau sphérique femelle ISO 228

Rubinetto a sfera femmina BSP ISO228



DN	THREAD ROSCA	Part nº Referencia	€
32	1"1/4 BSP	<b>BKH G 1 1/4 DN32</b>	<b>322,95</b>
40	1"1/2 BSP	<b>BKH G 1 1/2 DN40</b>	<b>373,81</b>
50	2" BSP	<b>BKH G 2 DN50</b>	<b>485,46</b>

# Llaves de paso alta presión

Ball valves high pressure  
Robinetts haute pression  
Rubinetti a sfera alta pressione

## Llave 3 vías hembra-hembra-hembra BSP (Tipo L)

3 Ways ball valve BSP female-female-female (Type L)

Robinet haute pression 3 voies série "L" boisseau sphérique femelle-femelle-femelle BSP

Rubinetto a sfera 3 vie femmina (Tipo L)



DN	THREAD ROSCA	Part nº Referencia	€
6	1/4" BSP	<b>BK3 G 1/4</b>	<b>76,20</b>
10	3/8" BSP	<b>BK3 G 3/8</b>	<b>76,20</b>
13	1/2" BSP	<b>BK3 G 1/2</b>	<b>88,87</b>
20	3/4" BSP	<b>BK3 G 3/4</b>	<b>174,98</b>
25	1" BSP	<b>BK3 G 1</b>	<b>240,26</b>

La entrada del caudal es solamente por la vía central / The input flow is only through the central way / L'entrée du débit est seulement par la voie centrale / L'ingresso al flusso è solo la linea centrale

## Llave 3 vías hembra multivía (Tipo L)

Multi-way ball valves female 3 ways (Type L)

Robinet haute pression 3 voies série "L" boisseau sphérique femelle gaz

Rubinetto a sfera 3 vie femmina (Tipo L)



DN	THREAD ROSCA	Part nº Referencia	€
4	1/8" BSP	<b>3KH G 1/8</b>	<b>434,97</b>
6	1/4" BSP	<b>3KH G 1/4</b>	<b>337,63</b>
10	3/8" BSP	<b>3KH G 3/8</b>	<b>381,06</b>
13	1/2" BSP	<b>3KH G 1/2</b>	<b>489,85</b>
20	3/4" BSP	<b>3KH G 3/4</b>	<b>840,82</b>
25	1" BSP	<b>3KH G 1</b>	<b>880,35</b>
25/32	1"1/4 BSP	<b>3KH G 1 1/4</b>	<b>957,53</b>
25/40	1"1/2 BSP	<b>3KH G 1 1/2</b>	<b>984,09</b>

La entrada del caudal puede ser por cualquiera de las 3 vías / The input flow can be done through any of the 3 ways / L'entrée du débit peut être par l'un des 3 voies / Il flusso in ingresso può essere da qualsiasi dei 3 vie

## Llave 4 vías rosca hembra BSP (Tipo X)

Multi-way ball valves female 4 ways (Type X)

Robinet haute pression 4 voies série "X" boisseau sphérique femelle gaz

Rubinetto 4 vie femmina BSP (Tipo X)



DN	THREAD ROSCA	Part nº Referencia	€
4	1/8" BSP	<b>4KH G 1/8</b>	<b>408,41</b>
6	1/4" BSP	<b>4KH G 1/4</b>	<b>471,46</b>
10	3/8" BSP	<b>4KH G 3/8</b>	<b>386,79</b>
13	1/2" BSP	<b>4KH G 1/2</b>	<b>460,49</b>
20	3/4" BSP	<b>4KH G 3/4</b>	<b>931,95</b>
25	1" BSP	<b>4KH G 1</b>	<b>968,49</b>
25/32	1"1/4 BSP	<b>4KH G 1 1/4</b>	<b>1.084,22</b>
25/40	1"1/2 BSP	<b>4KH G 1 1/2</b>	<b>1.139,04</b>

## Llave 3 vías hembra-hembra-hembra BSP (Tipo T)

3 Ways ball valve BSP female-female-female (Type T)

Robinet haute pression 3 voies série "T" boisseau sphérique femelle-femelle-femelle BSP

Rubinetto a sfera 3 vie femmina (Tipo T)



DN	THREAD ROSCA	Part nº Referencia	€
6	1/4" BSP	<b>BK3 G 1/4 T</b>	<b>76,20</b>
10	3/8" BSP	<b>BK3 G 3/8 T</b>	<b>76,20</b>
13	1/2" BSP	<b>BK3 G 1/2 T</b>	<b>88,87</b>
20	3/4" BSP	<b>BK3 G 3/4 T</b>	<b>174,98</b>
25	1" BSP	<b>BK3 G 1 T</b>	<b>240,26</b>

La entrada del caudal es solamente por la vía central / The input flow is only through the central way / L'entrée du débit est seulement par la voie centrale / L'ingresso al flusso è solo la linea centrale

## Llave 3 vías hembra-hembra-hembra NPT (Tipo L)

3 Ways ball valve NPT female-female-female (Type L)

Robinet haute pression 3 voies série "L" boisseau sphérique femelle-femelle-femelle NPT

Rubinetto a sfera 3 vie NPT femmina (Tipo L)



DN	THREAD ROSCA	Part nº Referencia	€
6	1/4" NPT	<b>BK3 1/4 NPT</b>	<b>110,62</b>
6	3/8" NPT	<b>BK3 3/8 NPT</b>	<b>115,50</b>
6	1/2" NPT	<b>BK3 1/2 NPT</b>	<b>94,87</b>
6	3/4" NPT	<b>BK3 3/4 NPT</b>	<b>192,04</b>
6	1" NPT	<b>BK3 1 NPT</b>	<b>264,68</b>

## Llaves especiales 3 vías macho-macho-macho (Tipo L)

Special 3 way valves male-male-male (Type L)

Robinetts spéciaux 3 voies série "L" mâle-mâle-mâle

Rubinetti speciali 3 vie maschio-maschio-maschio



THREAD ROSCA	DESCRIPTION DESCRIPCIÓN	Part nº Referencia	€
1/2" BSP	3 Ways	<b>A60030810</b>	<b>266,10</b>

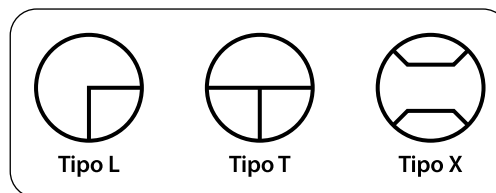

# Llaves de paso alta presión

Ball valves high pressure  
Robinets haute pression  
Rubinetti a sfera alta pressione

## Útil para cierre con candado tipo 2

Locking devices type 2

Dispositifs de verrouillage type 2

Dispositivo di bloccaggio tipo 2



DESCRIPTION DESCRIPCIÓN	Part nº Referencia	€
For ball valves: hex.9, DN4-8	<b>CANDT2-9A</b>	<b>35,27</b>
For ball valves: hex.9, DN10-13	<b>CANDT2-9B</b>	<b>35,27</b>
For ball valves: hex.14, DN20-25	<b>CANDT2-14</b>	<b>60,97</b>

## Útil para cierre con candado tipo 4

Locking devices type 4

Dispositifs de verrouillage type 4

Dispositivo di bloccaggio tipo 4



DESCRIPTION DESCRIPCIÓN	Part nº Referencia	€
For ball valves: Hex.9	<b>CANDT4-9</b>	<b>44,80</b>
For ball valves: Hex.14	<b>CANDT4-14</b>	<b>58,04</b>

## Manetas para llaves

Levers for ball valves

Leviers pour robinets

Manopole per rubinetti a sfera



SIZE TAMAÑO	Part nº Referencia	€
9	<b>AR603722</b>	<b>6,38</b>
9	<b>C600063</b>	<b>9,14</b>
9	<b>A60013155330</b>	<b>11,69</b>
12	<b>L501741</b>	<b>15,23</b>
14	<b>A60013155331</b>	<b>11,21</b>
14	<b>C708618</b>	<b>14,01</b>
14	<b>LR606745</b>	<b>14,02</b>
17	<b>LR801799</b>	<b>30,00</b>

Ver tabla de dimensiones en pág 336 / See dimension table in page 336 / Voir table de dimensions à la page 336 / Vedere tabella di dimensioni a pagina 336

Adaptors

Quick-release  
couplings

Ball valves

Diverters

Swivel fittings

Multi-way couplings

Protections

# Llaves de paso

Ball valves  
Robinets  
Rubinetti a sfera

## Manetas 1

Handles for ball-valves  
Leviers pour robinets  
Maniglia

## Manetas 2

Handles for ball-valves  
Leviers pour robinets  
Maniglia

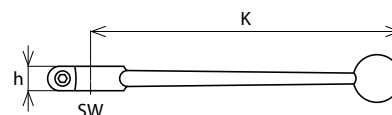
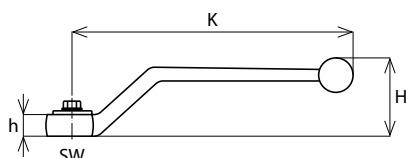

	SW	Zinc Zinc Zinco Zinc						Aluminio Aluminum Alluminio Aluminium			INOX/SS316L			Acero Steel Acier Acciaio		
Serie BSP 1/8 - 1/4 - 3/8 - 1/2 - 5/8	9	A60013155330* (1)			AR603722*						Z60013155330 *			C600063*		
Serie DIN 6 - 8 - 10 - 12 - 14 - 15 - 16		H	J	K	H	J	K	H	J	K	H	J	K	H	J	K
		45	8.7	155	-	10	155	45	8.7	155	47	9	155			
Serie BSP 3/8	12							L501741* (1)								
Serie DIN 18		H	J	K	H	J	K	H	J	K	H	J	K	H	J	K
		55	12	160												
Serie BSP 3/4 - 1 - 1 1/4	14	A60013155331* (1)						LR606745 *			Z60013155331*			C708618*		
Serie DIN 22 - 25 - 28 - 30 - 35 - 38		H	J	K	H	J	K	H	J	K	H	J	K	H	J	K
		-	13	200	-	12	200	-	13	200	64	12	171			
Serie BSP 1 1/4 - 1 1/2 - 2	17							LR801799* (1)			Z60013155332*					
Serie DIN 3 3-5 - 38 - 42		H	J	K	H	J	K	H	J	K	H	J	K	H	J	K
		-	16	320	-	15	90									

## Las llaves se suministran con maneta de zinc o aluminio

Handles for ball-valves are supplied with zinc or aluminum  
Leviers pour robinets fournis avec une poignée en zinc ou en aluminium  
I rubinetti sono forniti con maniglia dincate o alluminio

(1) Maneta sumistrada junto a la llave / Handles are supplied for ball-valves / Leviers sont fournies pour robinets / I rubinetti sono fornite con maniglia

# Llaves de paso baja presión

Low pressure Ball valves  
Robinets Basse pression  
Rubinetti Bassa pressione

## Llave de esfera baja presión

2 Ways ball valve low pressure

Robinet basse pression 2 voies boisseau  
sphérique pn 16/25



Rubinetti a sfera bassa pressione

PIPE TUBO	THREAD ROSCA	Part n° Referencia	€
10	1/4" BSP	<b>BP2V14</b>	<b>8,97</b>
10	3/8" BSP	<b>BP2V38</b>	<b>8,97</b>
15	1/2" BSP	<b>BP2V12</b>	<b>7,33</b>
20	3/4" BSP	<b>BP2V34</b>	<b>10,34</b>
25	1" BSP	<b>BP2V1</b>	<b>16,89</b>
32	1"1/4 BSP	<b>BP2V114</b>	<b>25,62</b>
40	1"1/2 BSP	<b>BP2V112</b>	<b>37,68</b>
50	2" BSP	<b>BP2V2</b>	<b>55,08</b>
74	3" BSP	<b>BP2V3</b>	<b>190,79</b>
92	4" BSP	<b>BP2V4</b>	<b>321,61</b>

## Llave de esfera baja presión anti-hielo

2 Ways ball valve low pressure non frozen

Robinet basse pression 2 voies boisseau  
sphérique pn 25 anti-gel



Rubinetti a sfera, anti-gelo

PIPE TUBO	THREAD ROSCA	Part n° Referencia	€
10	1/4" BSP	<b>BP2VA14</b>	<b>6,43</b>
10	3/8" BSP	<b>BP2VA38</b>	<b>6,54</b>
14,5	1/2" BSP	<b>BP2VA12</b>	<b>10,29</b>
19	3/4" BSP	<b>BP2VA34</b>	<b>14,71</b>
24	1" BSP	<b>BP2VA1</b>	<b>22,66</b>
30	1"1/4 BSP	<b>BP2VA114</b>	<b>38,04</b>
37	1"1/2 BSP	<b>BP2VA112</b>	<b>54,10</b>
47	2" BSP	<b>BP2VA2</b>	<b>86,64</b>
59	2"1/2 BSP	<b>BP2VA212</b>	<b>158,01</b>
70	3" BSP	<b>BP2VA3</b>	<b>244,76</b>
85,5	4" BSP	<b>BP2VA4</b>	<b>362,21</b>

# Llaves de paso alta presión TrΔle

TrΔle Ball Valves

Robinets TrΔle haute pression

Rubinetti a sfera TrΔle

## Llaves 2 vías hembra BSP con agujeros

2 Ways ball valve BSP female with holes

Robinet 2 voies boisseau sphérique BSP avec trous de fixation

Rubinetto a due vie con fori fissaggio



DN	THREAD ROSCA	Part nº Referencia	€
6	1/4" BSP	<b>GB2V 1/4</b>	<b>22,62</b>
10	3/8" BSP	<b>GB2V 3/8</b>	<b>27,60</b>
13	1/2" BSP	<b>GB2V 1/2</b>	<b>30,63</b>
20	3/4" BSP	<b>GB2V 3/4</b>	<b>46,89</b>
25	1" BSP	<b>GB2V 1</b>	<b>64,87</b>

## Llaves 2 vías rosca hembra NPT

2 Ways ball valve NPT female

Robinet 2 voies boisseau sphérique sortie femelle briggs (NPT)

Rubinetto a sfera 2 vie femmina NPT



DN	THREAD ROSCA	Part nº Referencia	€
6	1/4" NPT	<b>GB2V 1/4 NPT</b>	<b>22,62</b>
10	3/8" NPT	<b>GB2V 3/8 NPT</b>	<b>27,60</b>
13	1/2" NPT	<b>GB2V 1/2 NPT</b>	<b>30,63</b>
20	3/4" NPT	<b>GB2V 3/4 NPT</b>	<b>46,89</b>
25	1" NPT	<b>GB2V 1 NPT</b>	<b>64,87</b>

## Llaves paso 3 vías hembra-macho(60°)-hembra (tipo L)

3 Ways ball valve female-male(60°)-female (L type)

Robinet 3 voies femelle-mâle (60°)-femelle (type L)

Rubinetto a tre vie fem-maschio (60°)-fem (tipo L)



DN	THREAD ROSCA	Part nº Referencia	€
6	1/4" BSP	<b>GB3V 1/4</b>	<b>30,09</b>
10	3/8" BSP	<b>GB3V 3/8</b>	<b>47,79</b>
13	1/2" BSP	<b>GB3V 1/2</b>	<b>55,57</b>
20	3/4" BSP	<b>GB3V 3/4</b>	<b>72,25</b>
25	1" BSP	<b>GB3V 1</b>	<b>97,67</b>

## Llaves 2 vías tubo rígido Serie Ligera

2 Ways ball valve: tube connection Light Serie

Robinet 2 voies boisseau sphérique sortie pour tube rigide DIN Série Légère

Rubinetto a sfera maschio DIN 2353 Serie L



DN	PIPE TUBO	THREAD ROSCA	Part nº Referencia	€
6	6L	M12x1.5	<b>GB2V 6 L</b>	<b>22,62</b>
6	8L	M14x1.5	<b>GB2V 8 L</b>	<b>25,40</b>
8	10L	M16x1.5	<b>GB2V 10 L</b>	<b>24,74</b>
10	12L	M18x1.5	<b>GB2V 12 L</b>	<b>27,14</b>
13	15L	M22x1.5	<b>GB2V 15 L</b>	<b>28,98</b>
13	18L	M26x1.5	<b>GB2V 18 L</b>	<b>29,14</b>
20	22L	M30x2	<b>GB2V 22 L</b>	<b>58,22</b>
25	28L	M36x2	<b>GB2V 28 L</b>	<b>75,34</b>

## Llaves 2 vías tubo rígido Serie Pesada

2 Ways ball valve: tube connection Heavy Serie

Robinet 2 voies boisseau sphérique sortie pour tube rigide DIN Série Lourde

Rubinetto a sfera maschio DIN 2353 Serie S



DN	PIPE TUBO	THREAD ROSCA	Part nº Referencia	€
4	8S	M16x1.5	<b>GB2V 8 S</b>	<b>30,14</b>
6	10S	M18x1.5	<b>GB2V 10 S</b>	<b>25,91</b>
8	12S	M20x1.5	<b>GB2V 12 S</b>	<b>25,71</b>
13	16S	M24x1.5	<b>GB2V 16 S</b>	<b>40,68</b>
16	20S	M30x2	<b>GB2V 20 S</b>	<b>48,76</b>
20	25S	M36x2	<b>GB2V 25 S</b>	<b>65,06</b>
25	30S	M42x2	<b>GB2V 30 S</b>	<b>75,34</b>

## Llaves paso 3 vías hembra-hembra-hembra (tipo L)

3 Ways ball valve female-female-female (L type)

Robinet 3 voies femelle-femelle-femelle (type L)

Rubinetto a tre vie fem.-fem.-fem. (tipo L)



DN	THREAD ROSCA	Part nº Referencia	€
6	1/4" BSP	<b>GB3VH 1/4</b>	<b>34,66</b>
10	3/8" BSP	<b>GB3VH 3/8</b>	<b>47,79</b>
13	1/2" BSP	<b>GB3VH 1/2</b>	<b>55,57</b>
20	3/4" BSP	<b>GB3VH 3/4</b>	<b>72,25</b>
25	1" BSP	<b>GB3VH 1</b>	<b>97,67</b>

## Desviadores

*Diverters*

Déviateurs

*Deviatori di flusso*

## Desviadores manuales

*Diverters manual*

Déviateurs manuels

*Deviatori di flusso manuali*

343

4

## Desviadores manuales

*Diverters manual*

*Déviateurs manuels*

*Deviatori di flusso manuali*

- De 3 vías / 3 Way / 3 voies / 3 vie

| 343



D3V



D3VAP



D3V...CC

- De 4 vías / 4 Way / 4 voies / 4 vie

| 343



D4V

- De 6 vías / 6 Way / 6 voies / 6 vie

| 343



D6V



D6VAP

# Desviadores manuales

*Diverters manual*  
*Déviateurs manuels*  
*Deviatori di flusso manuali*

## Desviador de 3 vías rosca hembra BSP

*3 Way diverter BSP female*

*Déviateur manuel 3 voies femelle BSP*

*Deviatore di flusso 3 vie femmina*



THREAD ROSCA	Part nº Referencia	€
1/4" BSP	<b>D3V14</b>	<b>60,03</b>
3/8" BSP	<b>D3V38</b>	<b>53,87</b>
1/2" BSP	<b>D3V12</b>	<b>64,31</b>
3/4" BSP	<b>D3V34</b>	<b>75,31</b>
1" BSP	<b>D3V10</b>	<b>110,40</b>
1 1/2" BSP	<b>D3V112</b>	<b>343,00</b>

## Desviador 3 vías alta presión (400 bar)

*High pressure 3 way flow diverter (400 bar)*

*Déviateur manuel 3 voies haute pression (400 bar)*

*Deviatore di flusso 3 vie alta pressione (400 bar)*



DN	Part nº Referencia	€
3/8" BSP	<b>D3VAP38</b>	<b>69,26</b>
1/2" BSP	<b>D3VAP12</b>	<b>69,26</b>
3/4" BSP	<b>D3VAP34</b>	<b>91,25</b>

## Desviador de 3 vías centros cerrados

*3 Way closed centers diverter*

*Déviateur manuel 3 voies centres fermés*

*Deviatore di flusso 3 vie femmina centri chiusi*



THREAD ROSCA	MAX. FLOW (l/min) CAUDAL MÁX.	Part nº Referencia	€
1/2" BSP	90	<b>D3V12CC</b>	<b>72,67</b>
3/4" BSP	120	<b>D3V34CC</b>	<b>82,11</b>
3/8" BSP	60	<b>D3V38CC</b>	<b>60,03</b>

## Desviador de 4 vías

*4 Way diverter BSP female*

*Déviateur manuel 4 voies femelle BSP*

*Deviatore di flusso 4 vie femmina*



THREAD ROSCA	Part nº Referencia	€
1/4" BSP	<b>D4V14</b>	<b>75,46</b>
3/4" BSP	<b>D4V34</b>	<b>115,76</b>
1/2" BSP	<b>D4V12</b>	<b>92,18</b>
3/8" BSP	<b>D4V38</b>	<b>75,46</b>

## Desviador de 6 vías

*6 Way diverter BSP female*

*Déviateur manuel 6 voies femelle BSP*

*Deviatore di flusso 6 vie femmina*



THREAD ROSCA	Part nº Referencia	€
1/4" BSP	<b>D6V14</b>	<b>131,84</b>
3/8" BSP	<b>D6V38</b>	<b>120,38</b>
1/2" BSP	<b>D6V12</b>	<b>159,71</b>
3/4" BSP	<b>D6V34</b>	<b>177,93</b>

## Desviador 6 vías alta presión (400 bar)

*High pressure 6 way flow diverter (400 bar)*

*Déviateur manuel 6 voies haute pression (400 bar)*

*Deviatore di flusso 6 vie alta pressione (400 bar)*



DN	Part nº Referencia	€
3/8" BSP	<b>D6VAP38</b>	<b>111,03</b>
1/2" BSP	<b>D6VAP12</b>	<b>111,03</b>
3/4" BSP	<b>D6VAP34</b>	<b>153,91</b>

## Racores giratorios

*Swivel fittings*

Raccords tournants

*Raccordi girevoli*

### **Racores giratorios Serie Italiana**

*Swivel fittings Italian series*

Raccords tournants série Italienne

*Raccordi girevoli serie italiana*

347

### **Racores giratorios Serie TrΔle**

*TrΔle series Swivel fittings*

Raccords tournants série TrΔle

*Raccordi girevoli TrΔle*

348

5

## Racores giratorios Serie Italiana

*Swivel fittings Italian series*  
*Raccords tournants série Italienne*  
*Raccordi girevoli serie italiana*

■ BSP / BSP / BSP / BSP

| 347



GGL

GG90

■ NPT / NPT / NPT / NPT

| 347



GGL...NPT

GG90...NPT

## Racores giratorios Serie TrΔle

*TrΔle series Swivel fittings*  
*Raccords tournants série TrΔle*  
*Raccordi girevoli TrΔle*

■ BSP / BSP / BSP / BSP

| 348



RGR

RG90

# Racores giratorios Serie Italiana

Swivel fittings Italian series

Raccords tournants série Italienne

Raccordi girevoli serie italiana

## Racor giratorio recto BSP

*Straight swivel fittings BSP*

Raccord tournant droit BSP



*Giunto girevole BSP*

THREAD ROSCA	Part n° Referencia	€
1/4" BSP	<b>GGL 1/4</b>	<b>23,83</b>
3/8" BSP	<b>GGL 3/8</b>	<b>25,57</b>
1/2" BSP	<b>GGL 1/2</b>	<b>29,83</b>
3/4" BSP	<b>GGL 3/4</b>	<b>50,55</b>
1" BSP	<b>GGL 1</b>	<b>64,45</b>
1"1/4 BSP	<b>GGL 1 1/4</b>	<b>105,13</b>
1"1/2 BSP	<b>GGL 1 1/2</b>	<b>160,06</b>
2" BSP	<b>GGL 2</b>	<b>259,99</b>

## Racor giratorio 90° BSP

*Elbow 90° swivel fitting BSP*

Raccord tournant coude 90° BSP



*Giunto girevole a 90° BSP*

THREAD ROSCA	Part n° Referencia	€
1/4" BSP	<b>GG90 1/4</b>	<b>26,76</b>
3/8" BSP	<b>GG90 3/8</b>	<b>29,79</b>
1/2" BSP	<b>GG90 1/2</b>	<b>35,72</b>
3/4" BSP	<b>GG90 3/4</b>	<b>62,70</b>
1" BSP	<b>GG90 1</b>	<b>81,54</b>
1"1/4 BSP	<b>GG90 1 1/4</b>	<b>160,37</b>
1"1/2 BSP	<b>GG90 1 1/2</b>	<b>244,30</b>
2" BSP	<b>GG90 2</b>	<b>342,85</b>

## Racor giratorio recto NPT

*Straight swivel fittings NPT*

Raccord tournant droit NPT



*Giunto girevole NPT*

THREAD ROSCA	Part n° Referencia	€
1/4" NPT	<b>GGL 1/4 NPT</b>	<b>26,21</b>
3/8" NPT	<b>GGL 3/8 NPT</b>	<b>28,11</b>
1/2" NPT	<b>GGL 1/2 NPT</b>	<b>32,74</b>
3/4" NPT	<b>GGL 3/4 NPT</b>	<b>57,58</b>
1" NPT	<b>GGL 1 NPT</b>	<b>70,91</b>

## Racor giratorio 90° NPT

*Elbow 90° swivel fitting NPT*

Raccord tournant coude 90° NPT



*Giunto girevole a 90° NPT*

THREAD ROSCA	Part n° Referencia	€
1/4" NPT	<b>GG90 1/4 NPT</b>	<b>29,41</b>
3/8" NPT	<b>GG90 3/8 NPT</b>	<b>32,72</b>
1/2" NPT	<b>GG90 1/2 NPT</b>	<b>39,25</b>
3/4" NPT	<b>GG90 3/4 NPT</b>	<b>72,81</b>
1" NPT	<b>GG90 1 NPT</b>	<b>89,73</b>

# Racores giratorios Serie TrΔle

*TrΔle series Swivel fittings*

*Raccords tournants série TrΔle*

*Raccordi girevoli TrΔle*

## Racores giratorios rectos BSP

*Straight swivel fitting BSP*

*Raccord tournant droit BSP*

*Raccordo girevole BSP*



THREAD ROSCA	Part n° Referencia	€
1/4" BSP	<b>RGR 1/4</b>	<b>15,61</b>
3/8" BSP	<b>RGR 3/8</b>	<b>22,77</b>
1/2" BSP	<b>RGR 1/2</b>	<b>26,06</b>
3/4" BSP	<b>RGR 3/4</b>	<b>38,38</b>
1" BSP	<b>RGR 1</b>	<b>54,70</b>

## Racores giratorios 90° BSP

*Elbow 90° swivel fitting BSP*

*Raccord tournant coude 90° BSP*

*Raccordo girevole a 90° BSP*



THREAD ROSCA	Part n° Referencia	€
1/4" BSP	<b>RG90 1/4</b>	<b>17,54</b>
3/8" BSP	<b>RG90 3/8</b>	<b>27,07</b>
1/2" BSP	<b>RG90 1/2</b>	<b>36,45</b>
3/4" BSP	<b>RG90 3/4</b>	<b>46,33</b>
1" BSP	<b>RG90 1</b>	<b>67,66</b>

## Multienchufes

*Multi-way couplings*

Multi-coupleur

*Multinnesti rapidi*

## Multienchufe Serie TrΔle

*TrΔle Multi-way coupling*

Multi-coupleur TrΔle

*Multinesti TrΔle*

353

6

## Multienchufe Serie TrΔle

*TrΔle Multi-way coupling*  
 Multi-coupleur TrΔle  
 Multinesti TrΔle

- Multienchufe 4 vías diseño DICSA / Multi-way coupling 4 ways - DICSA design / Multi-coupleur 4 voies - design DICSA / Multinesti a 4 linee - design DICSA | 353



MEDD44



MEDD\_4

- Multienchufe 2 vías diseño DICSA / Multi-way coupling 2 ways - DICSA design / Multi-coupleur 2 voies - design DICSA / Multinesti a 2 linee - design DICSA | 353



MEDD22



MEDD\_2

- Componentes multienchufe 2 vías/4 vías diseño DICSA / Parts Multi-way coupling 2/4 ways - DICSA design / Pièces multi-coupleur 2/ 4 voies - design DICSA / Elementi per multi innesti a 2 e 4 vie | 353



A930 / A940



MEDD

# Multienchufe Serie TrΔle

TrΔle Multi-way coupling  
Multi-coupleur TrΔle  
Multinesti TrΔle

Adaptors

Quick-release couplings

Ball valves

Diverters

Swivel fittings

Multi-way couplings

Protections

## Multienchufe 4 vías con enchufes

Multi-way couplings 4 ways with couplings

Multi-coupleur 4 voies avec connecteur

Piastra multi-innesti a 4 linee, con innesti



C. E.	WAYS NR. Nº VIAS	Part nº Referencia	€
4 x F 1/2" BSP	4	<b>MEDD44H08</b>	<b>659,78</b>

## Partes multienchufe 4 vías

Multi-way couplings 4 ways parts

Éléments Multi-coupleur 4 voies

Elementi multi-innesti a 4 linee



C. E.	WAYS NR. Nº VIAS	Part nº Referencia	€
---	4	<b>MEDD4S</b>	<b>363,30</b>
4 X F 1/2" BSP	4	<b>MEDDH44H08</b>	<b>379,79</b>
4 X F 1/2" BSP	4	<b>MEDDM44H08</b>	<b>435,12</b>

## Multienchufe 2 vías con enchufes

Multi-way couplings 2 ways with couplings

Multi-coupleur 2 voies avec connecteur

Piastra multi-innesti a 2 linee, con innesti



C. E.	WAYS NR. Nº VIAS	Part nº Referencia	€
2 x F 1/2" BSP	2	<b>MEDD22H08</b>	<b>420,56</b>

## Partes multienchufe 2 vías

Multi-way couplings 2 ways parts

Éléments Multi-coupleur 2 voies

Elementi multi-innesti a 2 linee



C. E.	WAYS NR. Nº VIAS	Part nº Referencia	€
---	2	<b>MEDD2S</b>	<b>303,36</b>
2 X F 1/2" BSP	2	<b>MEDDH22H08</b>	<b>192,44</b>
2 X F 1/2" BSP	2	<b>MEDDM22H08</b>	<b>288,04</b>

## Enchufes rápidos

Quick-release couplings

Coupleurs rapides

Innesti rapidi



THREAD ROSCA	ISO SIZE TAMAÑO ISO	BG SIZE TAMAÑO BG	C. E.	Part nº Referencia	€
F 1/2" BSP	10	2	M	<b>A930108</b>	<b>47,22</b>
F 1/2" BSP	10	2	F	<b>A930208</b>	<b>47,22</b>

## Componentes y repuestos

Spare parts

Pièces Détachées

Ricambi



C. E.	Part nº Referencia	€
MEDD2, MEDD4	<b>SETA MEDD</b>	<b>13,54</b>
MEDD2	<b>MEDD1802</b>	<b>91,32</b>
MEDD4	<b>MEDD1804</b>	<b>128,09</b>

### MULTI - 2



### MULTI - 4



# Protecciones

*Protections*

Protections

*Protezioni*

## Tapones de plástico

*Plastic plugs*

Capuchons plastique

*Tappi di plastica*

359

## Muelles

*Springs*

Ressorts

*Spirali*

362

## Protecciones textiles

*Protections*

Protection textile

*Protezioni tessili*

364

## Fijaciones de seguridad

*Safety fixation*

Système de sécurité anti-fouet

*Fune di sicurezza*

367

7

## Tapones de plástico

*Plastic plugs*  
 Capuchons plastique  
 Tappi di plastica

- Tapones hembra para roscas macho / Female plugs for male thread / Capuchons plastique femelle pour filetage mâle / Tappi femmina per filettature maschio | 359



TFG

TFM

TFU

- Tapones para bridas / Plugs for flanges / Capuchons plastique de brides SAE / Tappi per flangia | 359



TS 3000

TS 6000

- Tapones macho para roscas hembra / Male plugs for female thread / Bouchons plastique mâle pour filetage femelle / Tappi maschio per filettature femmina | 360



TMG

TMM

TMU

- Cinta PTFE / PTFE Tape / Ruban PTFE / Nastro di PTFE | 360



M29990

- Tapones para latiguillos / Plugs for hoses / Capuchons pour tuyau / Tappi per tubi | 361



LHT

# Muelles

Springs  
Ressorts  
Spirali

- Muelles de plástico / Plastic springs / Ressorts plastique / Spirali di plastica

| 362



AMUELLE P

AMUELLE PR

AMUELLE HDPE

AMUELLE HDPEY

- Muelles metálicos / Metallic springs / Ressorts métalliques / Spirali metallica

| 363



AMUELLE

Adaptors

Quick-release  
couplings

Ball valves

Diverters

Swivel fittings

Multi-way couplings

Protections

## Protecciones textiles

*Protections*  
Protection textile  
*Protezioni tessili*

- Protección fibra de vidrio y cerámica / Fiberglass protection / Protection en fibre de verre / Protezione in fibra di vetro | 364



AVIDRIO

JITRAKOR

AVIDRIO S

BVIDRIO S

ACERAMICA

AVIDRIO FA

ROVISIVE

CSVIDRIO

- Protección textil / Protections / Protection textile / Protezioni tessile | 366



GT

ABRAZADERA

## Fijaciones de seguridad

*Safety fixation*  
Système de sécurité anti-fouet  
*Fune di sicurezza*

- Elementos de fijación de seguridad / Safety fixation elements / Système de sécurité anti-fouet / Componenti per fune di sicurezza | 367

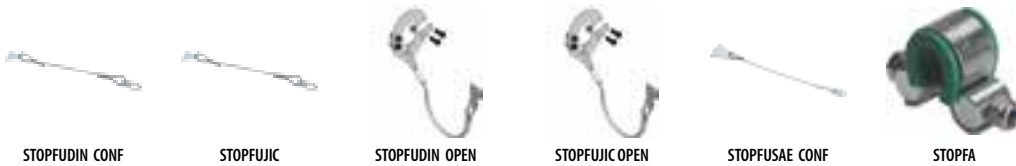

STOPFUDIN CONF

STOPFUJIC

STOPFUDIN OPEN

STOPFUJIC OPEN

STOPFUSAE CONF

STOPFA

# Tapones de plástico

Plastic plugs  
Capuchons plastique  
Tappi di plastica

Adaptors

Quick-release couplings

Ball valves

Diverters

Swivel fittings

Multi-way couplings

Protections

## Tapón plástico hembra rosca BSP

Plastic female cap - BSP thread

Bouchons plastique femelle - gaz

Tappo plastica femmina BSP



THREAD ROSCA	UNITS PER BAG CANTIDAD / BOLSA	Part nº Referencia	€
1/8" BSP	100	<b>TFG 1/8</b>	<b>0,15</b>
1/4" BSP	100	<b>TFG 1/4</b>	<b>0,16</b>
3/8" BSP	100	<b>TFG 3/8</b>	<b>0,19</b>
1/2" BSP	100	<b>TFG 1/2</b>	<b>0,18</b>
5/8" BSP	100	<b>TFG 5/8</b>	<b>0,28</b>
3/4" BSP	100	<b>TFG 3/4</b>	<b>0,21</b>
1" BSP	100	<b>TFG 1</b>	<b>0,30</b>
1"1/4 BSP	100	<b>TFG 1 1/4</b>	<b>0,45</b>
1"1/2 BSP	100	<b>TFG 1 1/2</b>	<b>0,48</b>
2" BSP	50	<b>TFG 2</b>	<b>0,71</b>

## Tapón plástico hembra rosca Métrica

Plastic female cap - Metric thread

Bouchons plastique femelle Métriques

Tappo plastica femmina Metrico



THREAD ROSCA	UNITS PER BAG CANTIDAD / BOLSA	Part nº Referencia	€
M12x1.5	100	<b>TFM 12X1.5</b>	<b>0,18</b>
M14x1.5	100	<b>TFM 14X1.5</b>	<b>0,17</b>
M16x1.5	100	<b>TFM 16X1.5</b>	<b>0,21</b>
M18x1.5	100	<b>TFM 18X1.5</b>	<b>0,20</b>
M20x1.5	100	<b>TFM 20X1.5</b>	<b>0,20</b>
M22x1.5	100	<b>TFM 22X1.5</b>	<b>0,20</b>
M24x1.5	100	<b>TFM 24X1.5</b>	<b>0,25</b>
M26x1.5	100	<b>TFM 26X1.5</b>	<b>0,22</b>
M30x2	100	<b>TFM 30X2</b>	<b>0,26</b>
M36x2	100	<b>TFM 36X2</b>	<b>0,32</b>
M42x2	100	<b>TFM 42X2</b>	<b>0,36</b>
M52x2	50	<b>TFM 52X2</b>	<b>0,74</b>

## Tapón plástico hembra rosca UNF/JIC

Plastic female cap - UNF (JIC) thread

Bouchons plastique femelle - JIC-UNF

Tappo plastica femmina UNF/JIC



THREAD ROSCA	UNITS PER BAG CANTIDAD / BOLSA	Part nº Referencia	€
7/16" UNF	100	<b>TFU 7/16</b>	<b>0,19</b>
1/2" UNF	100	<b>TFU 1/2</b>	<b>0,18</b>
9/16" UNF	100	<b>TFU 9/16</b>	<b>0,18</b>
3/4" UNF	100	<b>TFU 3/4</b>	<b>0,19</b>
7/8" UNF	100	<b>TFU 7/8</b>	<b>0,20</b>
1"1/16 UNF	100	<b>TFU 1 1/16</b>	<b>0,23</b>
1"5/16 UNF	100	<b>TFU 1 5/16</b>	<b>0,31</b>
1"5/8 UNF	100	<b>TFU 1 5/8</b>	<b>0,36</b>
1"7/8 UNF	100	<b>TFU 1 7/8</b>	<b>0,40</b>

## Tapón plástico para bridas 3000 PSI

Plastic caps for SAE 3000 PSI flanges

Bouchons plastique de brides SAE 3000 PSI

Tappo de plastica per flangia SAE 3000 PSI



DN	SERIE	SIZE TAMAÑO	UNITS PER BAG CANTIDAD / BOLSA	Part nº Referencia	€
30,2	3000 PSI	1/2"	100	<b>TS 3000 1/2</b>	<b>0,30</b>
38,1	3000 PSI	3/4"	100	<b>TS 3000 3/4</b>	<b>0,27</b>
44,5	3000 PSI	1"	100	<b>TS 3000 1</b>	<b>0,32</b>
50,8	3000 PSI	1"1/4	100	<b>TS 3000 1 1/4</b>	<b>0,35</b>
60,3	3000 PSI	1"1/2	100	<b>TS 3000 1 1/2</b>	<b>0,39</b>
71,4	3000 PSI	2"	100	<b>TS 3000 2</b>	<b>0,44</b>

## Tapón plástico para bridas 6000 PSI

Plastic caps for SAE 6000 PSI flanges

Bouchons plastique de brides SAE 6000 PSI

Tappo de plastica per flangia SAE 6000 PSI



DN	SERIE	SIZE TAMAÑO	UNITS PER BAG CANTIDAD / BOLSA	Part nº Referencia	€
31,8	6000 PSI	1/2"	100	<b>TS 6000 1/2</b>	<b>0,32</b>
41,3	6000 PSI	3/4"	100	<b>TS 6000 3/4</b>	<b>0,31</b>
47,6	6000 PSI	1"	100	<b>TS 6000 1</b>	<b>0,41</b>
54	6000 PSI	1"1/4	100	<b>TS 6000 1 1/4</b>	<b>0,42</b>
63,5	6000 PSI	1"1/2	100	<b>TS 6000 1 1/2</b>	<b>0,48</b>
79,4	6000 PSI	2"	50	<b>TS 6000 2</b>	<b>0,70</b>

# Tapones de plástico

Plastic plugs  
Capuchons plastique  
Tappi di plastica

## Tapón plástico macho rosca BSP

Plastic male plug for BSP thread

Bouchons plastique mâle - BSP

Tappo plastica maschio BSP



THREAD ROSCA	UNITS PER BAG CANTIDAD / BOLSA	Part nº Referencia	€
1/8" BSP	100	<b>TMG 1/8</b>	<b>0,17</b>
1/4" BSP	100	<b>TMG 1/4</b>	<b>0,16</b>
3/8" BSP	100	<b>TMG 3/8</b>	<b>0,18</b>
1/2" BSP	100	<b>TMG 1/2</b>	<b>0,22</b>
5/8" BSP	100	<b>TMG 5/8</b>	<b>0,23</b>
3/4" BSP	100	<b>TMG 3/4</b>	<b>0,25</b>
1" BSP	100	<b>TMG 1</b>	<b>0,35</b>
1 1/4" BSP	100	<b>TMG 1 1/4</b>	<b>0,50</b>
1 1/2" BSP	50	<b>TMG 1 1/2</b>	<b>0,88</b>
2" BSP	50	<b>TMG 2</b>	<b>0,90</b>

## Tapón plástico macho rosca Métrica

Plastic male plug for Metric thread

Bouchons plastique mâle - Métriques

Tappo plastica maschio Metrico



THREAD ROSCA	UNITS PER BAG CANTIDAD / BOLSA	Part nº Referencia	€
M12x1.5	100	<b>TMM 12X1.5</b>	<b>0,16</b>
M14x1.5	100	<b>TMM 14X1.5</b>	<b>0,17</b>
M16x1.5	100	<b>TMM 16X1.5</b>	<b>0,18</b>
M18x1.5	100	<b>TMM 18X1.5</b>	<b>0,23</b>
M20x1.5	100	<b>TMM 20X1.5</b>	<b>0,22</b>
M22x1.5	100	<b>TMM 22X1.5</b>	<b>0,22</b>
M24x1.5	100	<b>TMM 24X1.5</b>	<b>0,24</b>
M26x1.5	100	<b>TMM 26X1.5</b>	<b>0,26</b>
M30x2	100	<b>TMM 30X2</b>	<b>0,29</b>
M36x2	100	<b>TMM 36X2</b>	<b>0,40</b>
M42x2	50	<b>TMM 42X2</b>	<b>0,62</b>
M45x2	50	<b>TMM 45X2</b>	<b>0,77</b>
M52X2	50	<b>TMM 52X2</b>	<b>0,95</b>

## Tapón plástico macho rosca UNF/JIC

Plastic male plug for UNF (JIC) thread

Bouchons plastique mâle - JIC-UNF

Tappo plastica maschio UNF/JIC



THREAD ROSCA	UNITS PER BAG CANTIDAD / BOLSA	Part nº Referencia	€
7/16" UNF	100	<b>TMU 7/16</b>	<b>0,20</b>
1/2" UNF	100	<b>TMU 1/2</b>	<b>0,18</b>
9/16" UNF	100	<b>TMU 9/16</b>	<b>0,17</b>
3/4" UNF	100	<b>TMU 3/4</b>	<b>0,21</b>
7/8" UNF	100	<b>TMU 7/8</b>	<b>0,22</b>
1" 1/16 UNF	100	<b>TMU 1 1/16</b>	<b>0,26</b>
1" 5/16 UNF	100	<b>TMU 1 5/16</b>	<b>0,35</b>
1" 5/8 UNF	50	<b>TMU 1 5/8</b>	<b>0,63</b>
1" 7/8 UNF	50	<b>TMU 1 7/8</b>	<b>0,76</b>

## Cinta PTFE

PTFE Tape

Ruban PTFE

Nastro di PTFE



DESCRIPTION DESCRIPCIÓN	Part nº Referencia	€
1 roll	<b>M299900</b>	<b>1,18</b>
10 rolls	<b>M2999010</b>	<b>12,98</b>
200 rolls	<b>M29990200</b>	<b>260,00</b>

# Tapones de plástico

Plastic plugs  
Capuchons plastique  
Tappi di plastica

## Tapones para latiguillos

Caps for assemblies

Capuchons pour tuyau

Tappi per tubi



SIZE TAMAÑO	UNITS PER BAG CANTIDAD / BOLSA	Part nº Referencia	€
HEX14	100	LHT014	0,26
HEX16	100	LHT016	0,27
HEX17	100	LHT017	0,28
HEX19	100	LHT019	0,30
HEX22	100	LHT022	0,32
HEX24	100	LHT024	0,37
HEX25	100	LHT025	0,38
HEX27	100	LHT027	0,39
HEX30	100	LHT030	0,57
HEX32	100	LHT032	0,62
HEX36	100	LHT036	0,64
HEX41	50	LHT041	0,85
HEX46	50	LHT046	1,15
HEX50	50	LHT050	1,27
HEX55	50	LHT055	1,73
HEX60	25	LHT060	2,52
HEX65	25	LHT065	3,04
HEX70	25	LHT070	3,06
HEX75	25	LHT075	3,06
HEX80	25	LHT080	3,16



REDUCTION OF CODES  
VALID FOR MULTIPLE CONNECTIONS  
PRODUCTION INCREASE  
EASY ASSEMBLY  
GREATER PROTECTION

REDUCCIÓN DE CÓDIGOS  
VÁLIDO PARA MÚLTIPLES CONEXIONES  
AUMENTO DE LA PRODUCCIÓN  
FÁCIL COLOCACIÓN  
MAYOR PROTECCIÓN



# Muelles

Springs  
Ressorts  
Spirali

## Muelle de plástico plano

Flat plastic spring

Ressort plastique plat



Spirale di plastica piatta

DN	LENGTH (M) LONGITUD (M)	Thickness (mm) Espesor (mm)	SPIRAL PITCH PASO ESPIRAL	Part n° Referencia	€
12	50	1	8	AMUELLE P12	4,38
13	50	1	16	AMUELLE P13	4,98
15	50	1	16	AMUELLE P15	5,09
16	50	1	16	AMUELLE P16	5,14
17	50	1	16	AMUELLE P17	5,19
18	50	1	16	AMUELLE P18	5,30
20	50	1	16	AMUELLE P20	5,36
21	50	1	16	AMUELLE P21	5,52
22	50	1	16	AMUELLE P22	5,57
25	50	1	16	AMUELLE P25	6,38
28	50	1	16	AMUELLE P28	7,20
30	50	1	16	AMUELLE P30	7,41
33	20	2	16	AMUELLE P33	11,47
35	20	2	16	AMUELLE P35	11,69
38	20	2	16	AMUELLE P38	12,01
40	20	2	16	AMUELLE P40	12,23
45	20	2	16	AMUELLE P45	13,85
48	20	2	16	AMUELLE P48	14,39
50	20	2	16	AMUELLE P50	14,88
55	20	2	16	AMUELLE P55	17,58
60	20	2	16	AMUELLE P60	19,64
70	20	2	16	AMUELLE P70	23,97
80	15	2	16	AMUELLE P80	27,65

## Muelle de plástico redondo

Round plastic spring

Ressort plastique rond



Spirale di plastica rotonda

DN	LENGTH (M) LONGITUD (M)	Thickness (mm) Espesor (mm)	SPIRAL PITCH PASO ESPIRAL	Part n° Referencia	€
12 - 16	50	1.5	12	AMUELLE PR12	1,55
16 - 20	50	2	16	AMUELLE PR16	2,65
20 - 25	50	2.5	18	AMUELLE PR20	3,69
25 - 30	50	2.5	23	AMUELLE PR25	5,75

## AMUELLE

L = PASO ESPIRAL / SPIRAL PITCH  
e = ESPESOR / THICKNESS

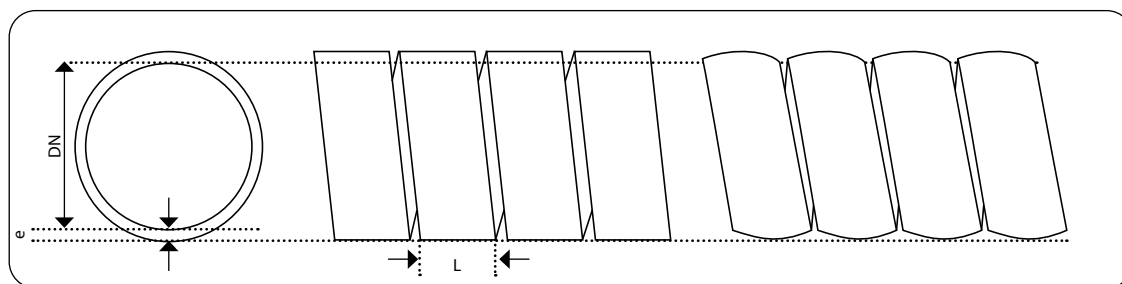

## Muelle plano PEAD, color negro

HDPE flat spring, black color

Ressort plat en HDPE, couleur noir



Spirale in HDPE, colore nero

DN	Ø OUTER Ø EXT.	LENGTH (M) LONGITUD (M)	Thickness (mm) Espesor (mm)	SPIRAL PITCH PASO ESPIRAL	Part n° Referencia	€
13	16	25	1.3	13	AMUELLE HDPE13	4,00
16	20	25	2	13	AMUELLE HDPE16	4,65
20	25	25	2.2	20	AMUELLE HDPE20	5,13
27	32	25	2.5	24	AMUELLE HDPE27	6,38
35	40	25	2.7	24	AMUELLE HDPE35	9,67
43	50	25	3.4	30	AMUELLE HDPE43	11,94
56	63	25	3.7	37	AMUELLE HDPE56	16,15
66	75	20	4.4	42	AMUELLE HDPE66	19,55

## Muelle plano PEAD, color amarillo

HDPE flat spring, yellow color

Ressort plat en HDPE, couleur jaune



Spirale in HDPE, colore giallo

DN	LENGTH (M) LONGITUD (M)	Thickness (mm) Espesor (mm)	SPIRAL PITCH PASO ESPIRAL	Part n° Referencia	€
13	25	1.3	13	AMUELLE HDPEY13	4,16
16	25	2	13	AMUELLE HDPEY16	4,84
20	25	2.2	20	AMUELLE HDPEY20	5,40
27	25	2.5	24	AMUELLE HDPEY27	6,75
35	25	2.7	24	AMUELLE HDPEY35	10,13
43	25	3.4	30	AMUELLE HDPEY43	12,55
56	25	3.7	37	AMUELLE HDPEY56	16,94
66	20	4.4	42	AMUELLE HDPEY66	20,54

# Muelles

Springs  
Ressorts  
Spirali

## Muelle metálico plano perfil 5x1

Flat metallic spring 5x1

Ressort métallique plat profil 5x1

Spirali in metallo piatta 5x1



DN	LENGTH (M) LONGITUD (M)	Part nº Referencia	€
16	4	AMUELLE16	10,59
18	4	AMUELLE18	10,70
20	4	AMUELLE20	10,76
22	4	AMUELLE22	11,42
24	4	AMUELLE24	12,08
26	4	AMUELLE26	12,63
28	4	AMUELLE28	14,45
30	4	AMUELLE30	14,89
32	4	AMUELLE32	15,39
34	4	AMUELLE34	15,83
38	4	AMUELLE38	16,77
40	4	AMUELLE40	17,43
42	4	AMUELLE42	18,64
47	4	AMUELLE47	20,08
52	2	AMUELLE52	20,85
60	2	AMUELLE60	23,55
68	1	AMUELLE68	28,96
72	1	AMUELLE72	30,34

### Podemos suministrar muelles metálicos redondos en acero galvanizado bajo plano. Consúltenos

We can supply rounded metallic springs in galvanized steel under drawing. Please, enquire us

Nous pouvons fournir des ressorts métalliques ronds en acier galvanisé sur plan. Consultez-nous

Possiamo fornire spirali metalliche in filo tondo di acciaio galvanizzato su richiesta.

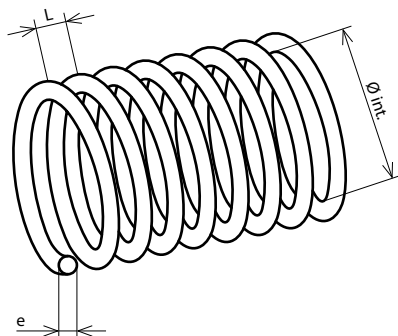

#### Datos necesarios para consultar:

Necessary data to enquire:

Données nécessaires pour consulter:

Dati necessari per l'ordine:

L = espacio entre alambres / space between wires / espace entre fils de fer / spazio tra

e = espesor alambre / wire thickness / épaisseur / spessore

Ø = Ø interior del muelle / Ø int. wire / Ø int. / interno della molla

Longitud del muelle / Spring length / Longueur du ressort / Longhezza della molla

# Protecciones textiles

Protections  
Protection textile  
Protezioni tessili

## Tubo de fibra de vidrio

Fibreglass tube

Gaine de fibre de verre

Tubo di fibra di vetro

Ø Inner Min. Ø INT. MIN.	Ø Inner Max. Ø INT. MAX.	DIAMETER (mm) DIAMETRO (mm)	Part n° Referencia	€
12	15	15	<b>AVIDRIO 15</b>	<b>3,31</b>
16	18	20	<b>AVIDRIO 20</b>	<b>4,42</b>
18	22	25	<b>AVIDRIO 25</b>	<b>5,53</b>
25	28	30	<b>AVIDRIO 30</b>	<b>6,68</b>
28	32	35	<b>AVIDRIO 35</b>	<b>8,10</b>
30	35	40	<b>AVIDRIO 40</b>	<b>8,84</b>
38	42	45	<b>AVIDRIO 45</b>	<b>10,31</b>
45	48	50	<b>AVIDRIO 50</b>	<b>11,05</b>
48	52	60	<b>AVIDRIO 60</b>	<b>16,20</b>
70	72	75	<b>AVIDRIO 75</b>	<b>20,62</b>



## Jitrakor cinta adhesiva

Jitrakor adhesive tape

Jitrakor bande adhesive

Jitrakor striscia adesiva

LENGTH (M) LONGITUD (M)	Part n° Referencia	€
10	<b>JITRAKOR</b>	<b>31,11</b>

€/rollo / €/roll / €/rouleau / €/rotolo



## Tubo de fibra de vidrio siliconado

Silicone fibreglass tube

Gaine de fibre de verre siliconée

Tubo di fibra di vetro siliconato

DN	Part n° Referencia	€
12	<b>AVIDRIO S 12</b>	<b>16,93</b>
16	<b>AVIDRIO S 16</b>	<b>18,69</b>
19	<b>AVIDRIO S 19</b>	<b>21,49</b>
25	<b>AVIDRIO S 25</b>	<b>28,85</b>
28	<b>AVIDRIO S 28</b>	<b>32,56</b>
32	<b>AVIDRIO S 32</b>	<b>34,91</b>
38	<b>AVIDRIO S 38</b>	<b>36,08</b>
51	<b>AVIDRIO S 51</b>	<b>54,77</b>
70	<b>AVIDRIO S 70</b>	<b>108,43</b>



## Tubo de fibra de vidrio siliconado serie B

B Series silicone fibreglass tube

Gaine de fibre de verre siliconée Série B

Tubo di fibra di vetro siliconato Serie B

DN	Part n° Referencia	€
12	<b>BVIDRIO S 12</b>	<b>11,40</b>
15	<b>BVIDRIO S 16</b>	<b>13,71</b>
19	<b>BVIDRIO S 19</b>	<b>15,78</b>
22	<b>BVIDRIO S 22</b>	<b>18,49</b>
25	<b>BVIDRIO S 25</b>	<b>21,20</b>
30	<b>BVIDRIO S 28</b>	<b>25,26</b>
32	<b>BVIDRIO S 32</b>	<b>29,09</b>



## Tubo de fibra cerámica

Ceramic fibre tube

Gaine de fibre de céramique

Tubo in fibra di ceramica

DN	Part n° Referencia	€
15	<b>ACERAMICA 15</b>	<b>8,72</b>
20	<b>ACERAMICA 20</b>	<b>10,48</b>
25	<b>ACERAMICA 25</b>	<b>11,45</b>
30	<b>ACERAMICA 30</b>	<b>16,44</b>
40	<b>ACERAMICA 40</b>	<b>21,79</b>
50	<b>ACERAMICA 50</b>	<b>27,18</b>
60	<b>ACERAMICA 60</b>	<b>32,66</b>
70	<b>ACERAMICA 70</b>	<b>40,78</b>



## Tubo de fibra de vidrio saturada

Saturated fibreglass tube

Gaine de fibre de verre saturée

Tubo in fibra di vetro saturato

Ø Inner Min. Ø INT. MIN.	Ø Inner Max. Ø INT. MAX.	Part n° Referencia	€
1/2"	3/4"	<b>AVIDRIO FA 08</b>	<b>10,88</b>
5/8"	1"	<b>AVIDRIO FA 10</b>	<b>14,72</b>
3/4"	1" 1/4	<b>AVIDRIO FA 12</b>	<b>19,60</b>
1"	1" 3/4	<b>AVIDRIO FA 16</b>	<b>29,17</b>
1" 1/2	2" 1/4	<b>AVIDRIO FA 24</b>	<b>44,93</b>
2" 1/2	4"	<b>AVIDRIO FA 40</b>	<b>71,57</b>



## Revestimiento de fibra de vidrio con velcro

Fibreglass with velcro shield

Rèvetement de fibre de verre avec velcro

Rivestimento di fibra di vetro con velcro

DIAMETER (mm) DIAMETRO (mm)	Part n° Referencia	€
1" 1/2 / 38 mm	<b>ROVISIVE 24</b>	<b>117,68</b>
2" / 50 mm	<b>ROVISIVE 32</b>	<b>137,28</b>
2" 3/4 - 70 mm	<b>ROVISIVE 44</b>	<b>165,99</b>



## Cinta silicona

Silicone tape

Ruban silicone

Rotolo di Silicone

LENGTH (mm) LONGITUD (mm)	Part n° Referencia	€
Roll 11m	<b>CSVIDRIO25</b>	<b>69,14</b>
Roll 11m	<b>CSVIDRIO38</b>	<b>103,33</b>



# Fibras

Fibers  
Fibres  
Fibre

## AVIDRIO

### Tubo de fibra de vidrio

*Fibreglass tube*

Fibra de alta calidad tipo E, no se quema y soporta exposiciones a temperaturas de 540 °C. Resiste la mayoría de ácidos y alcalinos y no le afecta la mayoría de disolventes ni lejías/blanqueantes.

*High-quality fiber type E, no burns and supports exposure to temperatures of 540 °C. Resists most acids and alkalis and is unaffected by most solvents or bleach.*



## AVIDRIO S

### Tubo de fibra de vidrio siliconado

*Silicone fibreglass tube*

Diseñado para proteger mangueras, alambres, etc. de los peligros del calor elevado y de las llamas ocasionales. Protección continua a 260 °C, soporta picos de hasta 1200 °C. Es resistente a fluidos hidráulicos, aceites lubricantes y combustibles. La funda siliconada protege contra la pérdida de energía en tubo rígido y manguera.

*Designed to protect hoses, wires and cables from the hazards of high heat and occasional flame. It protects continuously to 260 °C and will withstand a molten splash at 1200 °C. Resistant to hydraulic fluids, lubricating oils and fuels, it insulates against energy loss in piping and hosing.*



## BVIDRIO S

### Tubo de fibra de vidrio siliconado

*Silicone fibreglass tube*

Perfecto para proteger mangueras, tubos rígidos, etc. de elevadas temperaturas y llamas ocasionales. Ofrece protección continua a 260°C, con picos de hasta 1650°C. Resistente a salpicaduras de metales fundidos, fluidos hidráulicos, lubricantes y combustibles. La funda siliconada aísla el interior evitando la pérdida de energía en el tubo rígido o manguera.

*Perfect to protect hoses, pipes and cables from high temperatures, it protects continuously to 260°C and a maximum of 1650°C. Resistant to splashes of molten metals, hydraulic fluids, lubricating oils and fuels. The silicone cover insulates against energy loss in piping and hosing.*



## AVIDRIO FA

### Fibra de vidrio saturada

*Saturated fibreglass tube*

Proporciona protección continua hasta 540 °C. Es resistente a la mayoría de ácidos y alcalinos y no le afectan la mayoría de los disolventes ni lejías/blanqueantes. Es altamente flexible y adaptable; esto permite que una misma protección pueda colocarse en varios diámetros de tubo o incluso en montajes ya terminados (manguera/tubo + conexión/rácor). También es muy útil en longitudes largas de manguera o cable.

*Provides continuous protection up to 540 °C. It is resistant to most acids and alkalis and is not affected by most of the solvents or bleach. It is highly flexible and adaptable, this allows to place the same protection on various diameters of pipe, or even on already finished assemblies (hose/pipe + connection/fitting). It is also useful in long lengths of hose or cable.*

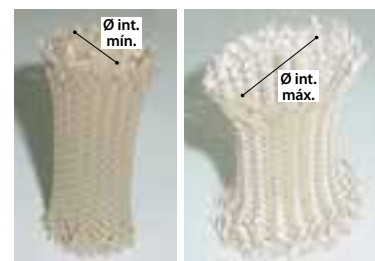

## ROVISIVE

### Revestimiento de fibra de vidrio siliconada con velcro

*Silicon fibreglass with velcro shield*

Diseñado para proteger mangueras, alambres, etc. de los peligros del calor elevado y de las llamas ocasionales. Protección continua a 260 °C, soporta picos de hasta 1200 °C. Su sistema de cierre con velcro permite el montaje *in situ* sin necesidad de quitar y poner los racores y terminales.

*Designed to protect hoses, wires and cables from the hazards of high heat and occasional flame. It protects continuously to 260 °C and will withstand a molten splash at 1200 °C. Its Velcro closure system allows application in-situ without the need to dismantle and reconnect fittings and terminations.*



## ACERAMICA

### Tubo de fibra cerámica

*Ceramic fibre tube*

La fibra cerámica está compuesta de silicato de aluminio. Es considerablemente resistente a altas temperaturas y tiene una estabilidad química excelente, resiste a los agentes más corrosivos, con la excepción del ácido fosfórico, ácido clorhídrico y bases fuertes. Tiene una excelente insonorización y aislamiento eléctrico, es de baja densidad y alta flexibilidad. No gotea en caso de incendio (no contiene agua). Sus características térmicas y físicas no se alteran por el agua, vapor o aceite.

*Ceramic fibre is composed of aluminium silicate. Is considerably resistant to high temperatures and has excellent chemical stability, resists to most corrosive agents, with the exception of phosphoric acid, hydrochloric acid and strong alkalis. It has excellent soundproofing and electric insulation, low density and high flexibility. Not dripping in case of fire (does not contain water). Its thermal and physical characteristics are not altered by water, steam or oil.*



Adaptors

Quick-release couplings

Ball valves

Diverters

Swivel fittings

Multi-way couplings

Protections

# Protecciones textiles

Protections  
Protection textile  
Protezioni tessili

## Tubo de protección textil

Textile protection tube

Gaine de protection textile

Tubo di protezione tessile



L	Ø OUTER Ø EXT.	Ø INNER Ø INT.	Part nº Referencia	€
35	20	18	<b>GT35</b>	<b>1,21</b>
40	22	20	<b>GT40</b>	<b>1,21</b>
45	25	23	<b>GT45</b>	<b>1,53</b>
50	30	28	<b>GT50</b>	<b>1,63</b>
55	32	30	<b>GT55</b>	<b>1,85</b>
65	38	36	<b>GT65</b>	<b>2,06</b>
80	47	43	<b>GT80</b>	<b>2,71</b>
120	78	68	<b>GT120</b>	<b>3,35</b>
150	92	85	<b>GT150</b>	<b>6,78</b>

## Accesorios tubo de protección textil

Textile protection tube accessories

Accessoires pour gaine de protection textile

Accessori per la protezione dei tessili



Ø Inner Min. Ø INT. MIN.	Ø Inner Max. Ø INT. MAX.	Part nº Referencia	€
13	15	<b>ABRAZADERA 13-15</b>	<b>0,79</b>
15	18	<b>ABRAZADERA 15-18</b>	<b>0,93</b>
20	23	<b>ABRAZADERA 20-23</b>	<b>1,22</b>
22	25	<b>ABRAZADERA 22-25</b>	<b>1,40</b>
23	27	<b>ABRAZADERA 23-27</b>	<b>1,54</b>
25	28	<b>ABRAZADERA 25-28</b>	<b>1,54</b>
40	43	<b>ABRAZADERA 40-43</b>	<b>3,26</b>
43	46	<b>ABRAZADERA 43-46</b>	<b>3,48</b>

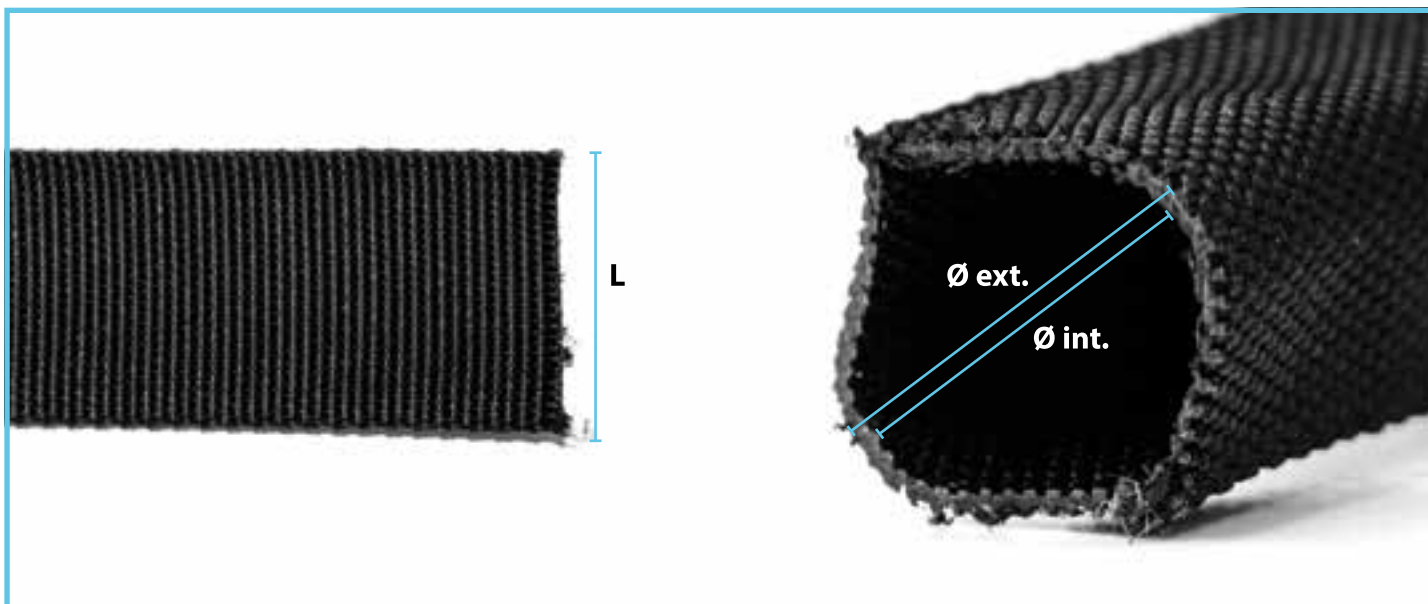

# Fijaciones de seguridad

Safety fixation

Système de sécurité anti-fouet

Fune di sicurezza

## Protección para DIN 2353

Retaining system to DIN 2353

Platines de fixation pour DIN 2353

Elementi di tenuta per DIN 2353

Ø INNER Ø INT.	DESCRIPTION DESCRIPCIÓN	MAX. PRESSURE (bar) PRESIÓN MAX. (bar)	Part n° Referencia	€
14.5 mm	8L - 1/4"	450	<b>STOPFUDIN 145 CONF</b>	<b>24,74</b>
17 mm	8S - 10L - 3/8"	445	<b>STOPFUDIN 17 CONF</b>	<b>24,74</b>
18.5 mm	10S - 12L	420	<b>STOPFUDIN 185 CONF</b>	<b>24,74</b>
20.5 mm	12S	420	<b>STOPFUDIN 205 CONF</b>	<b>24,74</b>
22.5 mm	14S - 15L - 1/2"	420	<b>STOPFUDIN 225 CONF</b>	<b>25,11</b>
24.5 mm	16S - 5/8"	420	<b>STOPFUDIN 245 CONF</b>	<b>25,11</b>
26.5 mm	18L - 3/4"	420	<b>STOPFUDIN 265 CONF</b>	<b>25,11</b>
30.5 mm	20S - 22L	420	<b>STOPFUDIN 305 CONF</b>	<b>25,85</b>
34 mm	1"	420	<b>STOPFUDIN 34 CONF</b>	<b>27,70</b>
36.5 mm	25S - 28L	420	<b>STOPFUDIN 365 CONF</b>	<b>27,70</b>
42.5 mm	30S - 1" 1/4	420	<b>STOPFUDIN 425 CONF</b>	<b>28,07</b>
45.5 mm	35L	420	<b>STOPFUDIN 455 CONF</b>	<b>28,43</b>
49 mm	1" 1/2	420	<b>STOPFUDIN 49 CONF</b>	<b>28,80</b>
52.5 mm	38S - 42L	385	<b>STOPFUDIN 525 CONF</b>	<b>29,17</b>
60 mm	2"	350	<b>STOPFUDIN 60 CONF</b>	<b>29,54</b>

Ver página 369 / See page 369 / Voir page 369 / Vedere p. 369

## Protección para JIC 37°

Retaining system to JIC 37°

Platines de fixation pour JIC 37°

Elementi di tenuta per JIC 37°

Ø INNER Ø INT.	DESCRIPTION DESCRIPCIÓN	MAX. PRESSURE (bar) PRESIÓN MAX. (bar)	Part n° Referencia	€
11,5	7/16	450	<b>STOPFUJIC 115 S</b>	<b>23,63</b>
13,2	1/2	450	<b>STOPFUJIC 132 S</b>	<b>23,63</b>
14,8	9/16	450	<b>STOPFUJIC 148 S</b>	<b>23,63</b>
19,5	3/4	420	<b>STOPFUJIC 195 S</b>	<b>23,63</b>
22,8	7/8	420	<b>STOPFUJIC 228 S</b>	<b>24,00</b>
27,5	1 1/16	420	<b>STOPFUJIC 275 S</b>	<b>24,74</b>
30,7	1 3/16	420	<b>STOPFUJIC 307 S</b>	<b>24,74</b>
34	1 5/16	420	<b>STOPFUJIC 34 L</b>	<b>30,28</b>
34	1 5/16	420	<b>STOPFUJIC 34 S</b>	<b>26,59</b>
41,5	1 5/8	420	<b>STOPFUJIC 415 L</b>	<b>31,39</b>
41,5	1 5/8	420	<b>STOPFUJIC 415 S</b>	<b>27,70</b>
48	1 7/8	420	<b>STOPFUJIC 48 L</b>	<b>31,39</b>
48	1 7/8	420	<b>STOPFUJIC 48 S</b>	<b>31,39</b>
64	2 1/2	350	<b>STOPFUJIC 64 L</b>	<b>39,88</b>

## Protección para DIN 2353 OPEN

Retaining system to DIN 2353 OPEN

Platines de fixation pour DIN 2353 OPEN

Elementi di tenuta per DIN 2353 OPEN

Ø INNER Ø INT.	DESCRIPTION DESCRIPCIÓN	MAX. PRESSURE (bar) PRESIÓN MAX. (bar)	Part n° Referencia	€
14.5 mm	8L - 1/4"	450	<b>STOPFUDIN 145 OPEN</b>	<b>46,16</b>
17 mm	8S - 10L - 3/8"	445	<b>STOPFUDIN 17 OPEN</b>	<b>46,16</b>
18.5 mm	10S - 12L	420	<b>STOPFUDIN 185 OPEN</b>	<b>46,16</b>
20.5 mm	12S	420	<b>STOPFUDIN 205 OPEN</b>	<b>46,16</b>
22.5 mm	14S - 15L - 1/2"	420	<b>STOPFUDIN 225 OPEN</b>	<b>46,16</b>
24.5 mm	16S - 5/8"	420	<b>STOPFUDIN 245 OPEN</b>	<b>46,16</b>
26.5 mm	18L - 3/4"	420	<b>STOPFUDIN 265 OPEN</b>	<b>46,16</b>
30.5 mm	20S - 22L	420	<b>STOPFUDIN 305 OPEN</b>	<b>47,27</b>
34 mm	1"	420	<b>STOPFUDIN 34 OPEN</b>	<b>53,55</b>
36.5 mm	25S - 28L	420	<b>STOPFUDIN 365 OPEN</b>	<b>53,55</b>
42.5 mm	30S - 1" 1/4	420	<b>STOPFUDIN 425 OPEN</b>	<b>54,28</b>
45.5 mm	35L	420	<b>STOPFUDIN 455 OPEN</b>	<b>54,28</b>
49 mm	1" 1/2	420	<b>STOPFUDIN 49 OPEN</b>	<b>54,28</b>
52.5 mm	38S - 42L	385	<b>STOPFUDIN 525 OPEN</b>	<b>55,02</b>
60 mm	2"	350	<b>STOPFUDIN 60 OPEN</b>	<b>55,39</b>

## Protección para JIC 37° OPEN

Retaining system to JIC 37° OPEN

Platines de fixation pour JIC 37° OPEN

Elementi di tenuta per JIC 37° OPEN

Ø INNER Ø INT.	DESCRIPTION DESCRIPCIÓN	MAX. PRESSURE (bar) PRESIÓN MAX. (bar)	Part n° Referencia	€
11,5	7/16	450	<b>STOPFUJIC 115 S OPEN</b>	<b>46,16</b>
13,2	1/2	450	<b>STOPFUJIC 132 S OPEN</b>	<b>46,16</b>
14,8	9/16	450	<b>STOPFUJIC 148 S OPEN</b>	<b>46,16</b>
19,5	3/4	420	<b>STOPFUJIC 195 S OPEN</b>	<b>46,16</b>
22,8	7/8	420	<b>STOPFUJIC 228 S OPEN</b>	<b>46,16</b>
27,5	1 1/16	420	<b>STOPFUJIC 275 S OPEN</b>	<b>47,27</b>
30,7	1 3/16	420	<b>STOPFUJIC 307 S OPEN</b>	<b>48,01</b>
34	1 5/16	420	<b>STOPFUJIC 34 L OPEN</b>	<b>53,55</b>
34	1 5/16	420	<b>STOPFUJIC 34 S OPEN</b>	<b>49,85</b>
41,5	1 5/8	420	<b>STOPFUJIC 415 L OPEN</b>	<b>54,65</b>
41,5	1 5/8	420	<b>STOPFUJIC 415 S OPEN</b>	<b>50,59</b>
48	1 7/8	420	<b>STOPFUJIC 48 L OPEN</b>	<b>55,02</b>
48	1 7/8	420	<b>STOPFUJIC 48 S OPEN</b>	<b>51,33</b>
64	2 1/2	350	<b>STOPFUJIC 64 L OPEN</b>	<b>55,76</b>

Assembly where hoses have already been installed.



Montaje en mangueras previamente instaladas.

# Fijaciones de seguridad

Safety fixation

Système de sécurité anti-fouet

Fune di sicurezza

## Protección para bridas

Retaining system for flanges

Platines de fixation pour brides

Protezione per flangie



Ø INNER Ø INT.	DESCRIPTION DESCRIPCIÓN	MAX. PRESSURE (bar) PRESIÓN MAX. (bar)	Part n° Referencia	€
8.5 mm	SAE FLANGE 1/2" 3000 & 6000 PSI	415	STOPFUSAE 085 CONF	28,07
10,5	SAE FLANGE 3/4"-1" -1" 1/4 3000 PSI & 3/4" 6000 PSI	420	STOPFUSAE 2105 CONF	28,43
10.5 mm	SAE FLANGE 3/4"-1" -1" 1/4 3000 PSI & 3/4" 6000 PSI	420	STOPFUSAE 105 CONF	28,80
12.5 mm	SAE FLANGE 1"-1/2"-2" 3000 PSI & 1" 6000 PSI	420	STOPFUSAE 125 CONF	29,54
14.5 mm	SAE FLANGE 1" 1/4 6000 PSI	420	STOPFUSAE 145 CONF	29,54
16.5 mm	SAE FLANGE 1" 1/2 6000 PSI	420	STOPFUSAE 165 CONF	30,28
20.5 mm	SAE FLANGE 2" 6000 PSI	350	STOPFUSAE 205 CONF	30,28
25 MM	SAE FLANGE 2" 1/2 6000 PSI	350	STOPFUSAE 25 CONF	82,35
32 MM	SAE FLANGE 3" 6000 PSI	210	STOPFUSAE 32 CONF	86,78

Ver página 369 / See page 369 / Voir page 369 / Vedere p. 369

## Abrazaderas

Fixation clamps

Colliers de fixation

Collari fissaggio



Ø INNER Ø INT.	Part n° Referencia	€
11-11.5 mm	STOPFA11115	7,76
12-12.5 mm	STOPFA12125	7,76
13-13.5 mm	STOPFA13135	7,76
14-15 mm	STOPFA1415	7,76
16-17 mm	STOPFA1617	7,76
17-18 mm	STOPFA1718	7,76
18-19 mm	STOPFA1819	7,76
20-21 mm	STOPFA2021	7,76
21-22 mm	STOPFA2122	7,76
22-23 mm	STOPFA2223	7,76
24-25 mm	STOPFA2425	8,12
25-26 mm	STOPFA2526	8,12
26-27 mm	STOPFA2627	8,12
27-28 mm	STOPFA2728	8,49
28-29 mm	STOPFA2829	8,49
30-31 mm	STOPFA3031	8,49
32-33 mm	STOPFA3233	8,49
34-35 mm	STOPFA3435	8,86
36-37 mm	STOPFA3637	8,86
38-39 mm	STOPFA3839	8,86
39-40 mm	STOPFA3940	8,86
40-41 mm	STOPFA4041	9,23
42-43 mm	STOPFA4243	9,23
43-44 mm	STOPFA4344	9,23
44-45 mm	STOPFA4445	9,23
45-47 mm	STOPFA4547	10,71
48-50 mm	STOPFA4850	10,71
51-53 mm	STOPFA5153	11,08
53-54 mm	STOPFA5354	11,08
54-56 mm	STOPFA5456	11,45
57-59 mm	STOPFA5759	11,45
60-62 mm	STOPFA6062	11,82
63-65 mm	STOPFA6365	11,82
66-68 mm	STOPFA6668	12,19
69-71 mm	STOPFA6971	12,19
72-74 mm	STOPFA7274	12,19
75-77 mm	STOPFA7577	12,19
78-80 mm	STOPFA7880	12,56
81-83 mm	STOPFA8183	12,56
84-86 mm	STOPFA8486	12,56
87-89 mm	STOPFA8789	12,93
90-92 mm	STOPFA9092	12,93
93-95 mm	STOPFA9395	13,29

# Fijaciones de seguridad

Safety system

Système de sécurité anti-fouet

Fune di sicurezza

Referencia Part No. Référence Codice	Ø	SP	Recomendado para Recommended for Recommandé pour Consigliato per
STOPFUDIN 145 CONF	14,5	2,5	8L - 1/4"
STOPFUDIN 17 CONF	17	2,5	8S - 10L - 3/8"
STOPFUDIN 185 CONF	18,5	2,5	10S - 12L
STOPFUDIN 205 CONF	20,5	2,5	12S
STOPFUDIN 225 CONF	22,5	2,5	14S - 15L - 1/2"
STOPFUDIN 245 CONF	24,5	2,5	16S - 5/8"
STOPFUDIN 265 CONF	26,5	2,5	18L - 3/4"
STOPFUDIN 305 CONF	30,5	3	20S - 22L
STOPFUDIN 34 CONF	34	3	1"
STOPFUDIN 365 CONF	36,5	3	25S - 28L
STOPFUDIN 425 CONF	42,5	3	30S - 1 1/4"
STOPFUDIN 455 CONF	45,5	3	35L
STOPFUDIN 49 CONF	49	3	1 1/2"
STOPFUDIN 525 CONF	52,5	3	38S - 42L
STOPFUDIN 60 CONF	60	3	2"
STOPFUSAE 085 CONF	8,5	4	Brida SAE 1/2" 3000 y 6000 PSI
STOPFUSAE 105 CONF	10,5	4	Brida SAE 3/4" - 1" - 1 1/4" 3000 PSI y 3/4" 6000 PSI
STOPFUSAE 125 CONF	12,5	4	Brida SAE 1 1/2" - 2" 3000 PSI y 1" 6000 PSI
STOPFUSAE 145 CONF	14,5	4	Brida SAE 1" 1/4" 6000 PSI
STOPFUSAE 165 CONF	16,5	4	Brida SAE 1" 1/2" 6000 PSI
STOPFUSAE 205 CONF	20,5	4	Brida SAE 2" 6000 PSI

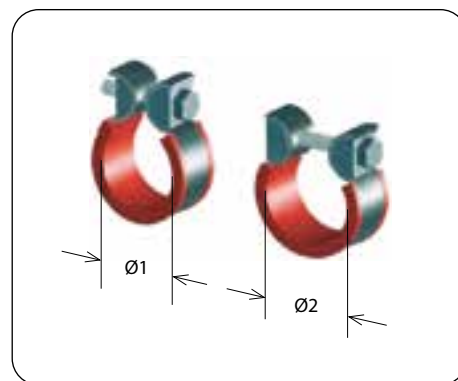
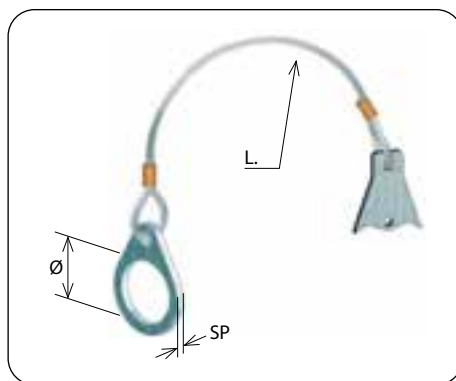

STOPFUDIN



STOPFUDIN



STOPFUSAE

