



Conexiones para flexibles

Crimp fittings for hoses
Embouts à sertir pour flexibles
Raccordi a pressione per tubi flessibili

1

Tubo rígido TRΔLE® / Racores DIN 2353 / Racores JIC 37°

TRΔLE® Rigid Pipe/ Pipe fittings DIN 2353/ Flare fittings JIC 37°
Tube rigide TRΔLE®/ Raccords DIN 2353/ Adapteurs JIC 37°
Tubo rigido TRΔLE®/ Raccordi DIN 2353/ Raccordi JIC 37°

2

Tubo rígido TRΔLE® SCH / Racores SCH / Bridas SAE / Abrazaderas

SCH TRΔLE® Rigid pipe/ SCH fittings / SAE Flanges / Clamps
Tube rigide TRΔLE® SCH / Embouts SCH / Brides SAE/ Colliers
Tubo rigido TRΔLE® SCH / Raccordi SCH / Flange SAE/ Collari fissatubo

3

Adaptadores

Adaptors
Adapteurs
Adattatori

4

Racores soldables

Welding fittings
Raccords à souder
Raccordi a saldare

5

Racores industriales

Industrial fittings
Raccords industriels
Raccordi industriali

6

Accesorios

Accessories
Accessoires
Accessori

7

Componentes hidráulicos AISI 316

Hydraulic Components AISI 316
Composants Hydrauliques AISI 316
Componenti Idraulici AISI 316

8

Metrología

Flow measuring
Test du circuit hydraulique
Test per circuiti idraulici

9

Racor doble anillo TRΔLE® Lok

Twin Ferrule Fittings TRΔLE® Lok
Raccord double bagues TRΔLE® Lok
Raccordi per doppio anello TRΔLE® Lok

10

Conexiones para flexibles

Crimping fittings for hoses

Embouts à sertir pour flexibles

Raccordi a pressare per tubi flessibili

Conexiones Standard	21
<i>Standard series</i> Embouts série standard <i>Serie Standard</i>	
Conexiones Serie BW R12/4SP/4SH No Pelar	39
<i>Fittings BW Series R12/4SP/4SH No Skive</i> Embouts R12/4SP/4SH Série BW Sans dénuder <i>Raccordi R12/4SP/4SH Serie BW senza spellatura</i>	
Conexiones Interlock	43
<i>Interlock series</i> Embouts Interlock <i>Serie Interlock</i>	
Conexiones una sola pieza Serie 43 R1AT/R2AT/1SN/2SN/R16/2SC/R17	47
<i>One piece fittings 43 Series R1AT/R2AT/1SN/2SN/R16/2SC/R17</i> Embouts pré-sertis R1AT/R2AT/1SN/2SN/R16/2SC/R17 Série 43 <i>Raccordi compatti R1AT/R2AT/1SN/2SN/R16/2SC/R17 Serie 43</i>	
Conexiones una sola pieza R7/ R8/ Elastómero malla metálica	53
<i>One piece fittings R7/R8 & Elastomer Braid of steel wire</i> Embouts pré-sertis R7/R8 et Elastomère tresse métallique <i>Raccordi compatti serie R7/R8 e elastomero treccia metallica</i>	
Conexiones una sola pieza PTFE Liso / R14	57
<i>One piece fittings for Smooth PTFE/ R14</i> Embouts pré-sertis pour PTFE lisse/ R14 <i>Raccordi compatti per PTFE liscio/ R14</i>	
Conexiones una sola pieza PTFE Corrugado	62
<i>One piece fittings for convoluted PTFE</i> Embouts pré-sertis pour PTFE convoluté <i>Raccordi compatti per PTFE convoluto</i>	



Conexiones una sola pieza Serie BW R12/4SP/4SH

67

One piece fittings BW Series R12/4SP/4SH
Embouts pré-sertis R12/4SP/4SH Série BW
Raccordi Compatti R12/4SP/4SH Serie BW

Casquillos para conexiones una sola pieza

72

Ferrules for one piece fittings
Jupes pour embouts pré-sertis
Boccole per raccordi compatti

Conexiones Reusables

73

Reusable series
Embouts série récupérable
Serie Recuperabile

Conexiones Push-On

76

Push-On Fittings
Embouts Push-On
Raccordi Serie Push-On

Conexiones Alta Presión (700 bar)

77

High pressure 700 bar fittings
Embouts haute pression 700 bar
Raccordi Altissima pressione (700 bar)

Serie Standard

Serie Standard
Standard serie
Standard serie











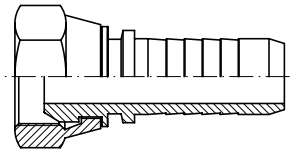

Una única conexión para una amplia gama de mangueras

One only fitting for a big hose range

Un seul raccord pour une grande gamme de tuyaux

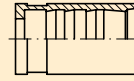
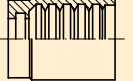
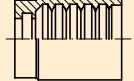
Un solo raccordo per una vasta gamma di tubi

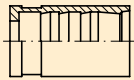
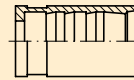
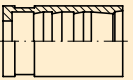
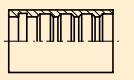
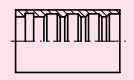

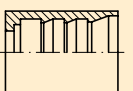
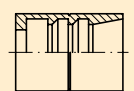
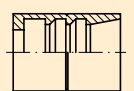
							
	SAE 100 R6	EN 854 2TE	EN 854 3TE	EN 857 1SC SUPERSERVICE 15C 155°	EN 853 1SN SAE 100 R1AT 1SNK	EN 853 2SN SAE 100 R2AT 2SNK	EN 857 2SC SUPERSERVICE 25C 155°
							
	81014...	81014...	ZPF22120...	ZSC2112...	ZPF22120... ZSC2112	ZPF22120...	ZPF22120...
							
	SAE 100 R7 EN 855 No conductiva	SAE 100 R8 EN 855 No conductiva	Metallic braid elastomer		Smooth PTFE 1 braid	Smooth PTFE 2 braid	Convoluted PTFE Std. Fiberglass Antistatic
							
	81014...	81014...	81014...		81040...	81045...	81041...
							
	EN 853 2ST SAE100 R2A	EN 856 4SP SAE 100 R9R	EN 856 R12 SAE 100	3SP EN856 4SP - 4SH - R12 SAE 100 R9R		Ecology 200	Ecology 250
							
	ZPF12240...	ZPF12240...	ZPF12240...	ZPF2224...		Z2120...	Z2120...

Serie Interlock

Interlock serie
Série Interlock
Serie Interlock

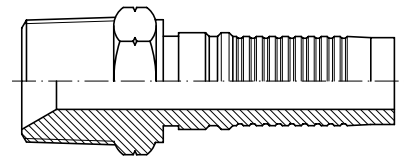

■ Una única conexión para toda la gama de mangueras de alta presión
One only fitting for all very high pressure hoses
Un seul raccord pour tous les tubes de très haute pression
Un solo raccordo per tutti i tubi ad altissima pressione

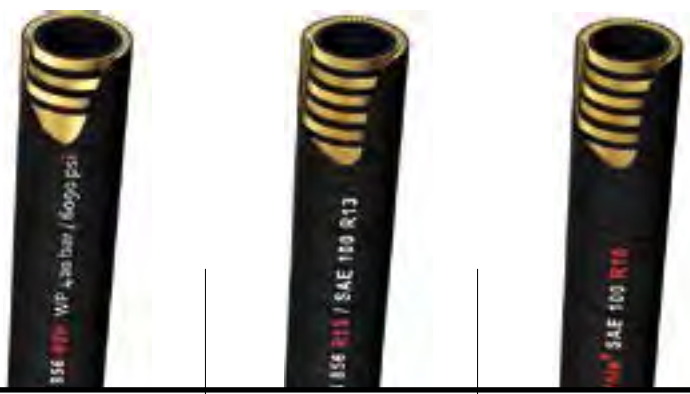

EN 856 4SH	EN 856 R13 SAE 100	SAE 100 R15
ZA61010...	ZA61010... Z61010...	ZA61010... Z61010...

Serie BW no pelar

BW Series no skiving
Série BW sans dénuder
Serie BW senza spellatura

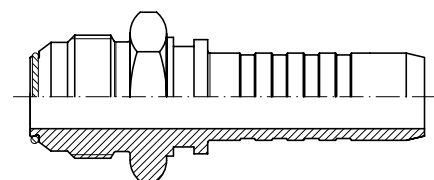

EN 856 4SP SAE 100	EN 856 4SH	EN 856 R12 SAE 100
ZAC68010	ZAC68010	ZAC68010

Crimping fittings for hoses

Pipe fittings

Pipe fittings II

Adaptors

Welding fittings

Industrial fittings

Accessories

Control components

Flow measuring

TrAie LOK

Serie Compacta

One Piece Series
Série Pré-sertis
Serie Compatti

■ Conexiones compactas 1SC / 1SN / 2SC / R6 / 2TE

One piece fittings 1SC / 1SN / 2SC / R6 / 2TE
Embouts pré-sertis 1SC / 1SN / 2SC / R6 / 2TE
Raccordi compatti 1SC / 1SN / 2SC / R6 / 2TE

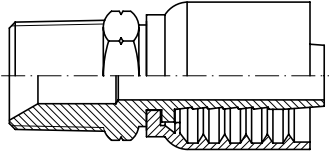

EN 857 1SC	EN 853 1 SN SAE 100 R1AT	EN 857 2SC	EN 854 SAE 100 R6	EN 854 2TE
---------------	-----------------------------------	---------------	-------------------------	---------------

■ Conexiones compactas Serie 43 R1AT / R2AT / 1SN / 2SN / R16 / 2SC / 3TE

One piece fittings 43 Series R1AT / R2AT / 1SN / 2SN / R16 / 2SC / 3TE
Embouts pré-sertis R1AT / R2AT / 1SN / 2SN / R16 / 2SC Série 43 / 2TE
Raccordi compatti R1AT / R2AT / 1SN / 2SN / R16 / 2SC Serie 43 / 3TE

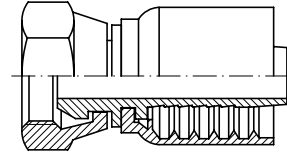

EN 853 1SN SAE 100 R1AT	EN 853 2 SN SAE 100 R2AT	EN 857 2SC SAE 100 R16	SUPERSERVICE 155° 2SC	3TE
----------------------------------	-----------------------------------	---------------------------------	-----------------------------	-----

■ Conexiones compactas Serie Standard NO PELAR 3SP / 4SP / 4SH / R12

One piece fittings Standar Series NON SKIVE 3SP / 4SP / 4SH / R12
Embouts pré-sertis SANS DÉNUDÉ 3SP / 4SP / 4SH / R12
Raccordi compatti SENZA PELATURA 3SP / 4SP / 4SH / R12

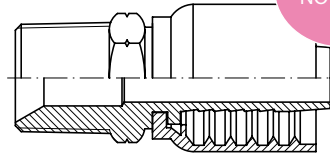

3SP	EN 856 4SP SAE 100 R9R	EN 856 4SH	EN856 R12 SAE 100
-----	------------------------------	---------------	-------------------------

■ Conexiones compactas R7 / R8 y elastómero malla metálica

Piece fittings R7 / R8 & braid of steel wire
Embouts pré-sertis R7 / R8 et tresse métallique
Raccordi compatti serie R7 / R8 e elastomero treccia metallica

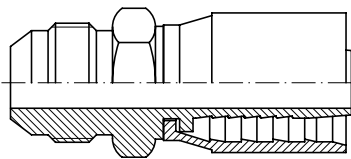

SAE 100 R7	SAE 100 R8	Metallic braid elastomer
---------------	---------------	--------------------------------

■ Conexiones compactas PTFE liso

One piece fittings for smooth PTFE
Embouts pré-sertis pour PTFE lisse
Raccordi compatti serie PTFE liscio

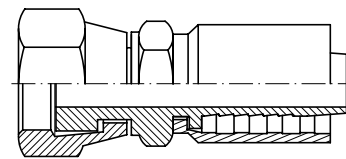

Smooth PTFE 1 braid

■ Conexiones compactas PTFE corrugado

One piece fittings for convoluted PTFE
Embouts pré-sertis pour PTFE convolute
Raccordi compatti serie PTFE convoluto

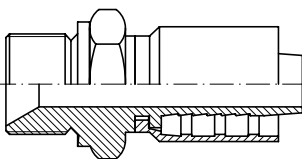

Convoluted PTFE

■ Conexiones compactas Serie BW R12 / 4SP / 4SH

One piece fittings BW Series R12 / 4SP / 4SH
Embouts pré-sertis R12 / 4SP / 4SH Série BW
Raccordi compatti R12 / 4SP / 4SH Serie BW

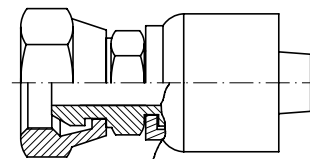

EN 856 R12	EN 856 4SP	4 SH
---------------	---------------	------

Pipe fittings

Pipe fittings II

Adaptors

Welding fittings

Industrial fittings

Accessories

Control components

Flow measuring

Tralle LOK

Conexiones Standard

Standard series
Embouts série standard
Serie Standard

■ Casquillos para prensar / Crimping ferrules / Jupes à sertir / Boccole a pressare | 21

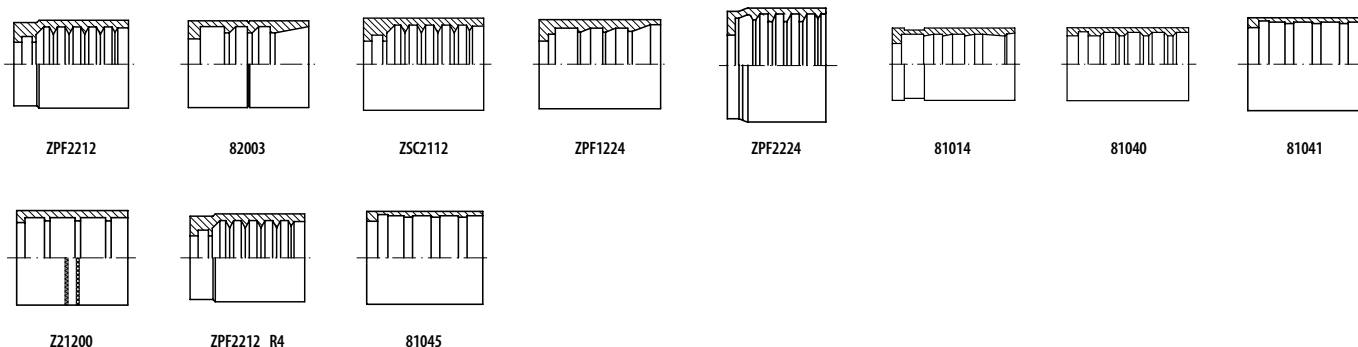

■ Conexiones BSP / BSP Fittings / Embouts BSP / Raccordi BSP | 24

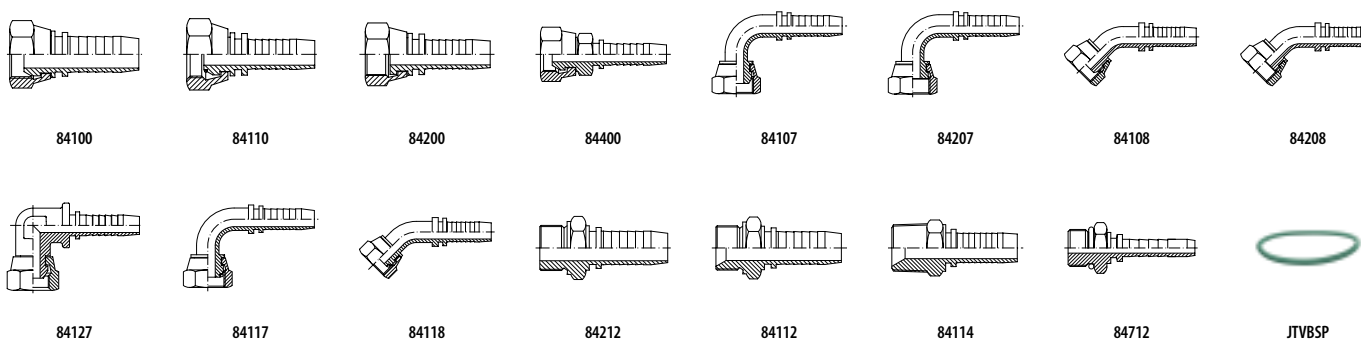

■ Conexiones NPT-NPSM / NPT-NPSM Fittings / Embouts NPT-NPSM / Raccordi NPT-NPSM | 28

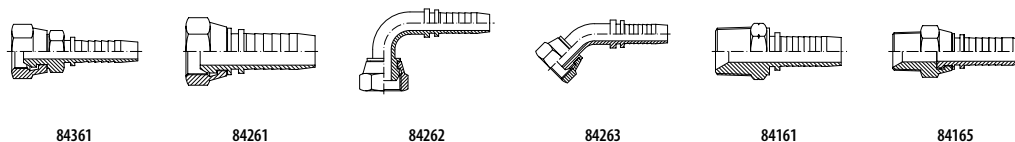

■ Conexiones JIC 37° / JIC 37° Fittings / Embouts JIC 37° / Raccordi JIC 37° | 29

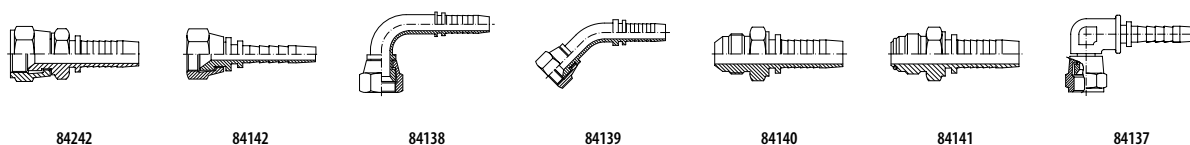

■ Conexiones Métricas DIN 2353 / Metric fittings / Embouts Métriques / Raccordi Metrici | 31

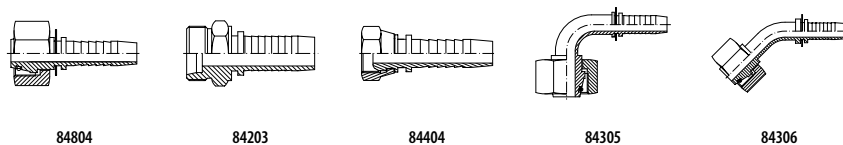

■ Espigas lisas / Standpipes / Embouts lisses / Estremità tubolari | 33

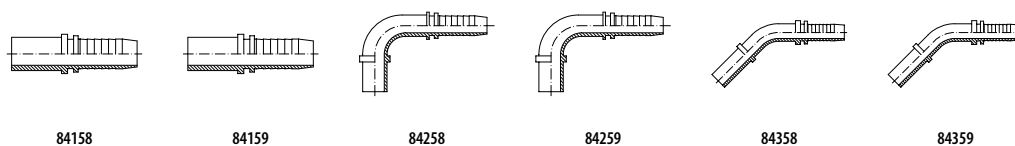

Conexiones Standard

Standard series

Embouts série standard

Serie Standard

Pipe fittings

■ Conexiones Varias / Other Fittings / Autres / Raccordi vari

34

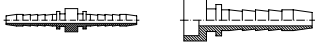

84300

84000

Pipe fittings II

■ Orientables / Banjos / Embouts Banjo / Raccordi ad occhio

35

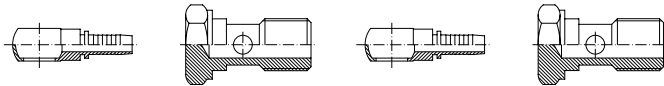

84111

Z1090

84116

Z1092

Adaptors

■ Terminales hidrolavadoras / Hydrowashing machine couplings / Embouts pour hydronettoyages / Raccordi per idropultrici

35

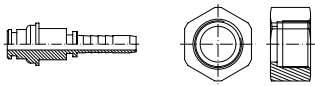

83050

KZTHAP

Welding fittings

■ Bridas SAE / SAE Flanges / Brides SAE / Flange SAE

36

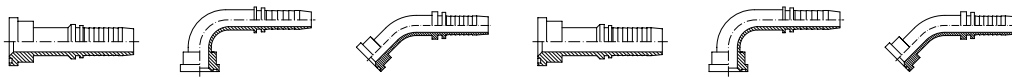

84182

84183

84184

84282

84283

84284

Industrial fittings

■ Bridas para flexibles / SAE Flanges for hoses / Brides SAE pour flexibles / Flange per tubi flessibili

37

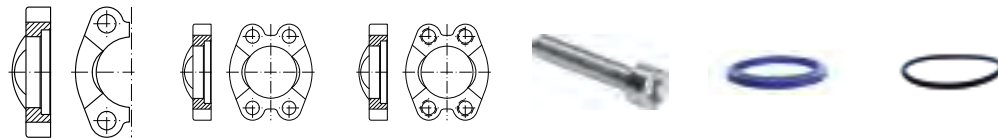

ZBBP

ZBBE

ZBCE

ZTB

JBR

ORING

Accessories

Control components

■ Conexiones ORFS / ORFS Fittings / Embouts ORFS / ORFS

38

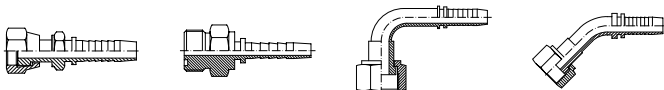

84901

84912

84907

84908

Flow measuring

Trazle LOK

Conexiones Serie BW R12/4SP/4SH No Pelar

Fittings BW Series R12/4SP/4SH No Skive

Embouts R12/4SP/4SH Série BW Sans dénuder

Raccordi R12/4SP/4SH Serie BW senza spellatura

■ Conexiones BSP / BSP fittings / Embouts BSP / Raccordi BSP | 39

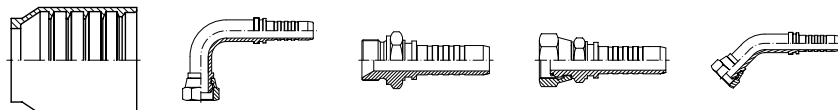

ZAC68010

Z66117

Z66112

Z66410

Z66118

■ Conexiones NPT/NPSM / NPT/NPSM fittings / Embouts NPT/NPSM / Raccordi NPT/NPSM | 40

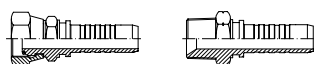

Z66461

Z66161

■ Conexiones JIC 37° / JIC 37° fittings / Embouts JIC / Raccordi JIC 37° | 40

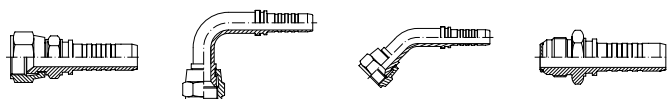

Z66242

Z66138

Z66139

Z66141

■ Conexiones ORFS / ORFS fittings / Embouts ORFS / Raccordi ORFS | 41

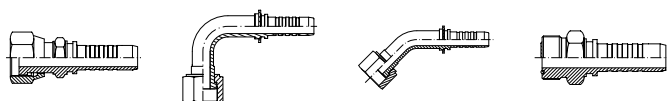

Z66901

Z66907

Z66908

Z66912

■ Conexiones Métricas DIN 2353 / Metric fittings / Embouts Métriques / Raccordi Metrici | 41

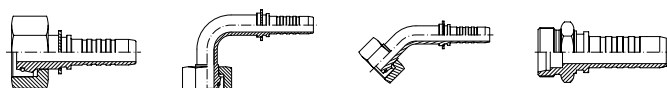

Z66204

Z66205

Z66206

Z66203

■ Bridas SAE / SAE Flanges / Brides SAE / Flange SAE | 42

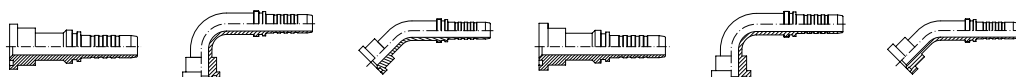

Z66182

Z66183

Z66184

Z66282

Z66283

Z66284

Conexiones Interlock

Interlock series

Embouts Interlock

Serie Interlock

Pipe fittings

- Casquillos Interlock / Interlock Crimping ferrules / Jupes à sertir Interlock / Boccole a pressare | 43

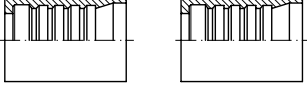

ZA61010

Z61010

Pipe fittings II

- Conexiones BSP / Interlock BSP fittings / Embouts à sertir Interlock BSP / Raccordi BSP | 43

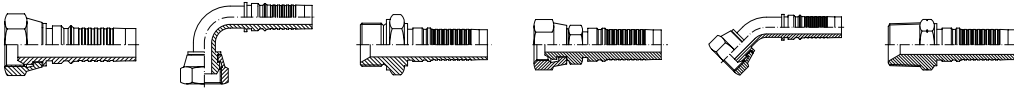

Z64100

Z64107

Z64112

Z64400

Z64108

Z64161

Adaptors

- Conexiones JIC 37° / Interlock JIC 37° fittings / Embouts à sertir Interlock JIC / Raccordi JIC 37° | 44

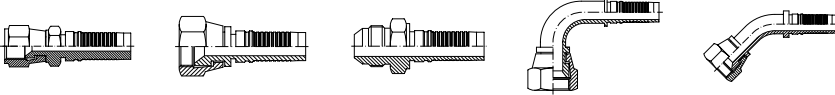

Z64242

Z64142

Z64140

Z64138

Z64139

Welding fittings

- Conexiones Métricas DIN 2353 / Interlock Metric fittings / Embouts Métrique Interlock / Raccordi Metrici | 45

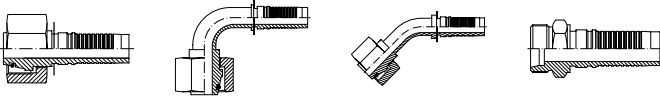

Z64204

Z64205

Z64206

Z64203

Industrial fittings

- Conexiones ORFS / Interlock ORFS fittings / Embouts à sertir Interlock ORFS / Raccordi ORFS | 45

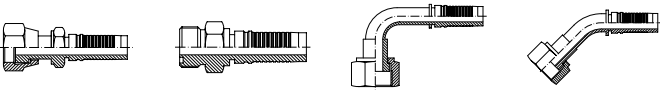

Z64901

Z64912

Z64907

Z64908

Accessories

Control components

- Bridas SAE / Interlock SAE Flanges / Brides SAE Interlock / Flange SAE | 46

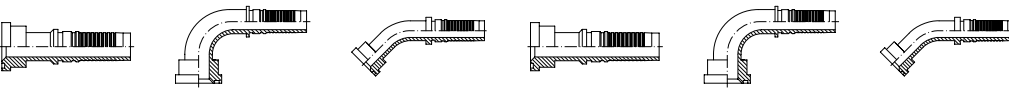

Z64182

Z64183

Z64184

Z64282

Z64283

Z64284

Flow measuring

Trazle LOK

Conexiones una sola pieza Serie 43 R1AT/R2AT/1SN/2SN/R16/2SC/R17

One piece fittings 43 Series R1AT/R2AT/1SN/2SN/R16/2SC/R17

Embouts pré-sertis R1AT/R2AT/1SN/2SN/R16/2SC/R17 Série 43

Raccordi compatti R1AT/R2AT/1SN/2SN/R16/2SC/R17 Serie 43

■ Conexiones una sola pieza JIC 37° / One piece JIC 37° fittings / Embouts pré-sertis JIC 37° / Raccordi compatti JIC 37° | 47

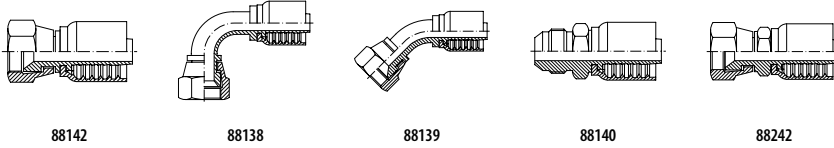

88142

88138

88139

88140

88242

■ Conexiones una sola pieza ORFS / One piece ORFS fittings / Embouts pré-sertis ORFS / Raccordi compatti ORFS | 48

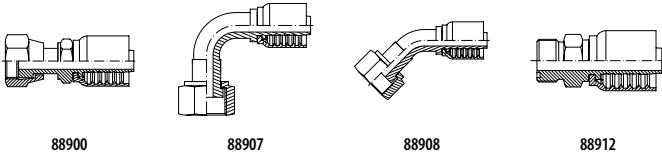

88900

88907

88908

88912

■ Conexiones una sola pieza NPT-NPSM / One piece NPT-NPSM fittings / Embouts pré-sertis NPT-NPSM / Raccordi compatti NPT-NPSM | 49

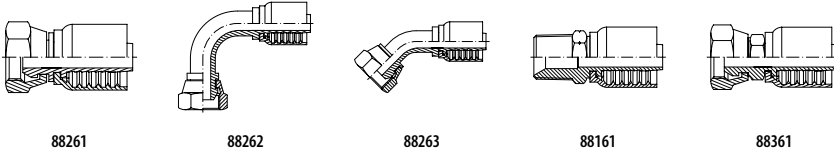

88261

88262

88263

88161

88361

■ Conexiones una sola pieza Bidas SAE / One piece SAE Flanges fittings / Embouts pré-sertis Bidas SAE / Raccordi compatti Flange SAE | 50

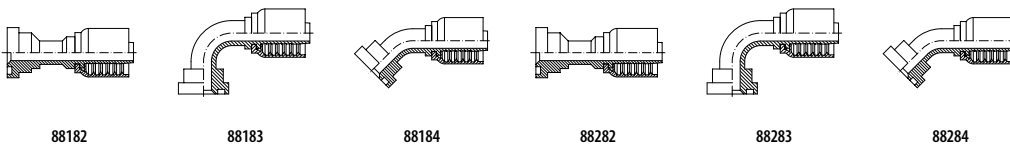

88182

88183

88184

88282

88283

88284

■ Conexiones una sola pieza Métricas / One piece Metric fittings / Embouts pré-sertis Métriques / Raccordi compatti Metrici | 51

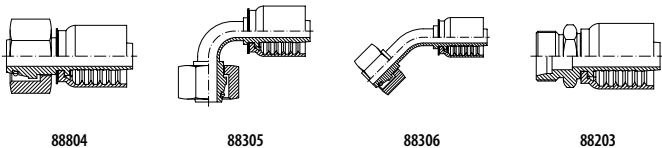

88804

88305

88306

88203

■ Conexiones una sola pieza BSP / One piece BSP fittings / Embouts pré-sertis BSP / Raccordi compatti BSP | 52

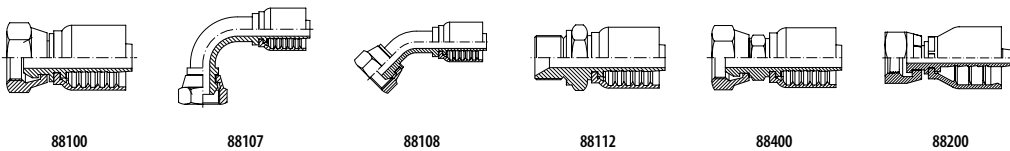

88100

88107

88108

88112

88400

88200

Conexiones una sola pieza R7/ R8/ Elastómero malla metálica

One piece fittings R7/R8 & Elastomer Braid of steel wire

Embouts pré-sertis R7/R8 et Elastomère tresse métallique

Raccordi compatti serie R7/R8 e elastomero treccia metallica

Pipe fittings

- Conexiones una sola pieza R7/R8 JIC 37° / 37° JIC One piece fittings R7/R8 / Embouts pré-sertis R7/R8 JIC 37° / Raccordi compatti serie R7/R8 JIC sede 37° | 53

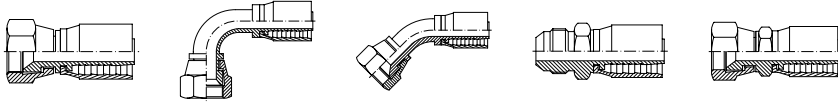

87142

87138

87139

87140

87242

Pipe fittings II

- Conexiones una sola pieza R7/R8 ORFS / ORFS One piece fittings R7/R8 / Embouts pré-sertis R7/R8 ORFS / Raccordi compatti serie R7/R8 ORFS | 54

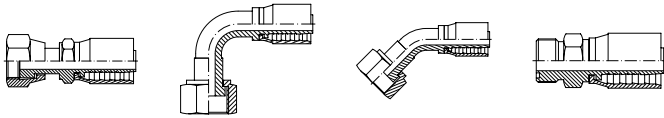

87900

87907

87908

87912

Adaptors

- Conexiones una sola pieza R7/R8 NPT-NPSM / NPT-NPSM One piece fittings R7/R8 / Embouts pré-sertis R7/R8 NPT-NPSM Raccordi compatti serie R7/R8 NPT-NPSM/ | 54

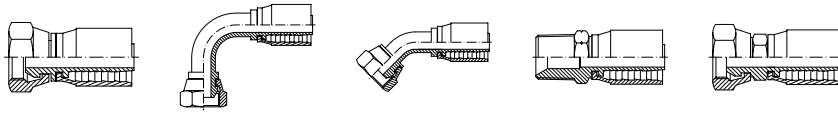

87261

87262

87263

87161

87361

Welding fittings

- Conexiones una sola pieza R7/R8 Métricas / Metric One piece fittings R7/R8 / Embouts pré-sertis R7/R8 Métriques / Raccordi compatti serie R7/R8 Metrici | 55

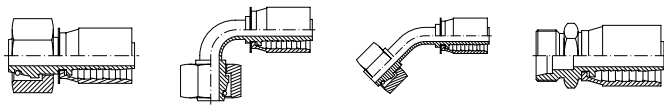

87804

87305

87306

87203

Industrial fittings

- Conexiones una sola pieza R7/R8 BSP / BSP One piece fittings R7/R8 / Embouts pré-sertis R7/R8 BSP / Raccordi compatti serie R7/R8 BSP | 56

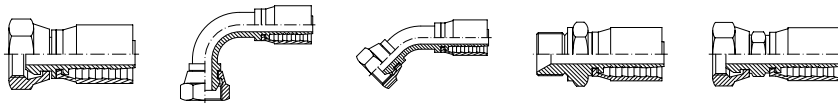

87100

87107

87108

87112

87400

Accessories

Control components

Flow measuring

Triede LOK

Conexiones una sola pieza PTFE Liso / R14

One piece fittings for Smooth PTFE/ R14
 Embouts pré-sertis pour PTFE lisse/ R14
 Raccordi compatti per PTFE liscio/ R14

■ Conexiones una sola pieza PTFE liso / R14 JIC 37° / 37° JIC One piece fittings smooth PTFE / R14 / Embouts pré-sertis PTFE lisse / R14 JIC 37° / Raccordi compatti serie PTFE liscio / R14 JIC 37° | 57

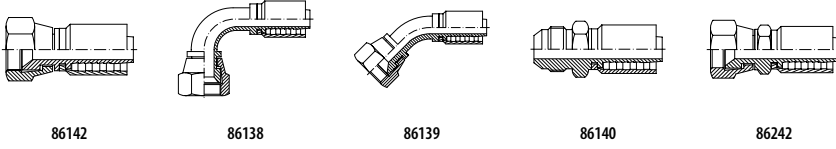

86142

86138

86139

86140

86242

■ Conexiones una sola pieza PTFE liso / R14 ORFS / ORFS One piece fittings smooth PTFE / R14 / Embouts pré-sertis PTFE lisse / R14 ORFS / Raccordi compatti serie PTFE liscio / R14 ORFS | 58

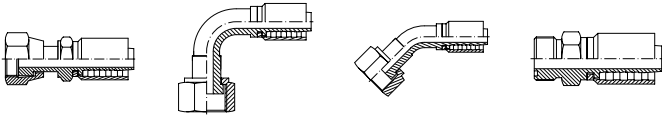

86900

86907

86908

86912

■ Conexiones una sola pieza PTFE liso / R14 NPT-NPSM / NPT-NPSM One piece fittings smooth PTFE / R14 / Embouts pré-sertis PTFE lisse / R14 NPT-NPSM / Raccordi compatti serie PTFE liscio / R14 NPT-NPSM | 59

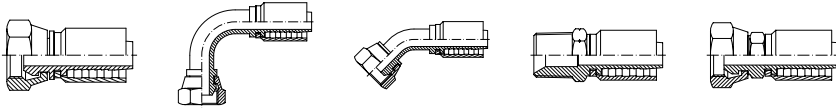

86261

86262

86263

86161

86361

■ Conexiones una sola pieza PTFE liso / R14 Métricas / Metric One piece fittings smooth PTFE / R14 / Embouts pré-sertis PTFE lisse / R14 Métriques Raccordi compatti serie PTFE liscio / R14 Metrici/ | 60

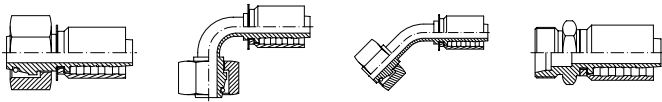

86804

86305

86306

86203

■ Conexiones una sola pieza PTFE liso / R14 BSP / BSP One piece fittings smooth PTFE / R14 / Embouts pré-sertis PTFE lisse / R14 BSP Raccordi compatti serie PTFE liscio / R14 BSP/ | 61

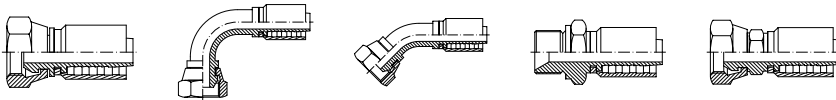

86100

86107

86108

86112

86400

Conexiones una sola pieza PTFE Corrugado

One piece fittings for convoluted PTFE
 Embouts pré-sertis pour PTFE convoluté
 Raccordi compatti per PTFE convoluto

Pipe fittings

- Conexiones una sola pieza PTFE Corrugado JIC 37° / One piece fittings for convoluted PTFE JIC 37° / Embouts pré-sertis pour PTFE convoluté JIC 37° / Raccordi compatti serie PTFE convoluto JIC 37° | 62

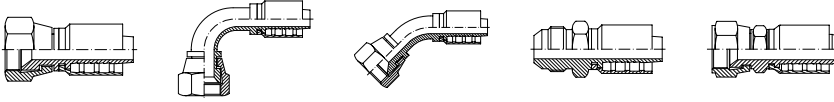

85142

85138

85139

85140

85242

Pipe fittings II

- Conexiones una sola pieza PTFE Corrugado ORFS / One piece fittings for convoluted PTFE ORFS / Embouts pré-sertis pour PTFE convoluté ORFS / Raccordi compatti serie PTFE convoluto ORFS / | 63

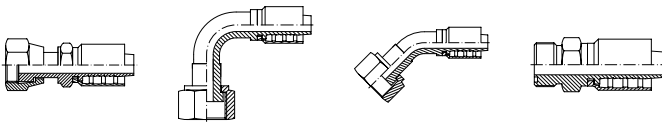

85900

85907

85908

85912

Adaptors

- Conexiones una sola pieza PTFE Corrugado NPT-NPSM / One piece fittings for convoluted PTFE NPT / Embouts pré-sertis pour PTFE convoluté NPT-NPSM / Raccordi compatti serie PTFE convoluto NPT | 64

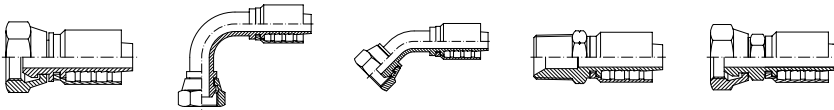

85261

85262

85263

85161

85361

Welding fittings

- Conexiones una sola pieza PTFE Corrugado Métricas / One piece fittings for convoluted PTFE Metrical / Embouts pré-sertis pour PTFE convoluté Métriques / Raccordi compatti serie PTFE convoluto METRICAL | 65

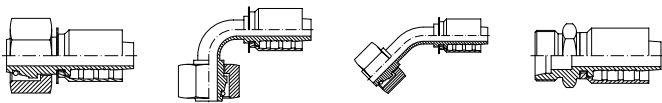

85804

85305

85306

85203

Industrial fittings

- Conexiones una sola pieza PTFE Corrugado BSP / One piece fittings for convoluted PTFE BSP / Embouts pré-sertis pour PTFE convoluté BSP / Raccordi compatti serie PTFE convoluto BSP | 66

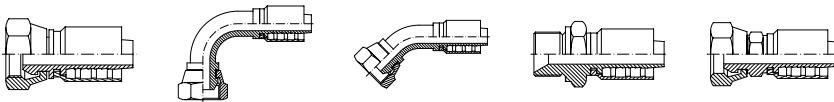

85100

85107

85108

85112

85400

Accessories

Control components

Flow measuring

Trazle LOK

Conexiones una sola pieza Serie BW R12/4SP/4SH

One piece fittings BW Series R12/4SP/4SH
 Embouts pré-sertis R12/4SP/4SH Série BW
 Raccordi Compatti R12/4SP/4SH Serie BW

- Conexiones una sola pieza JIC 37° / One piece JIC 37° fittings / Embouts pré-sertis JIC / Raccordi compatti JIC 37° | 67

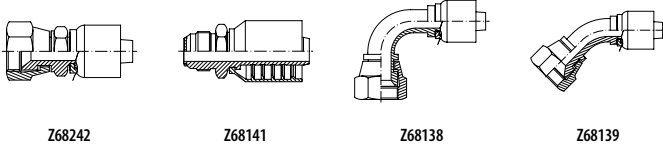

- Conexiones una sola pieza ORFS / One piece ORFS fittings / Embouts pré-sertis ORFS / Raccordi compatti ORFS | 68

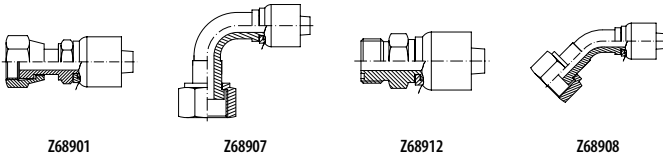

- Conexiones una sola pieza NPT/NPSM / One piece NPT/NPSM fittings / Embouts pré-sertis NPT/NPSM / Raccordi compatti NPT/NPSM | 68

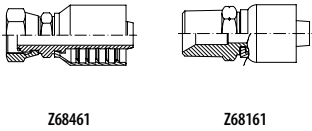

- Conexiones una sola pieza Bidas SAE / One piece SAE Flanges / Brides SAE pré-serties / Flange SAE compatta | 69

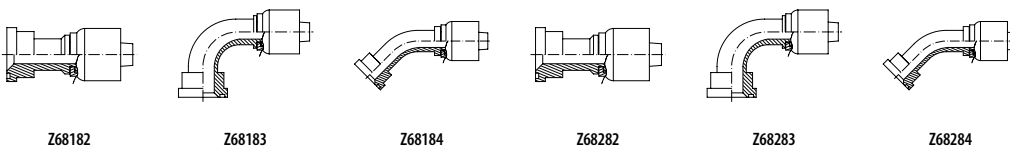

- Conexiones una sola pieza Métricas DIN 2353 / One piece Metric fittings / Embouts pré-sertis Métriques / Raccordi compatti Metrici | 70

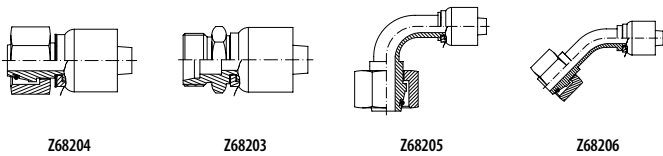

- Conexiones una sola pieza BSP / One piece BSP fittings / Embouts pré-sertis BSP / Raccordi compatti BSP | 71

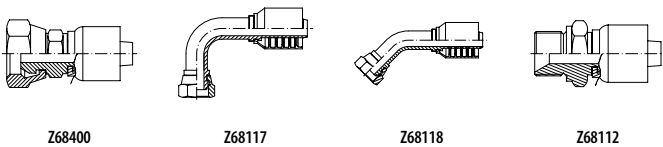

Casquillos para conexiones una sola pieza

Ferrules for one piece fittings
Jupes pour embouts pré-sertis
Boccole per raccordi compatti

■ Casquillos para Conexiones una sola pieza / Ferrules for one piece fittings / Jupes pour embouts pré-sertis / Boccole per raccordi compatti

72

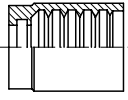

ZPFC2212

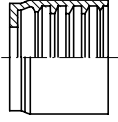

ZPF2224

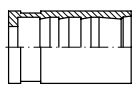

88012

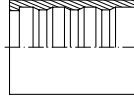

88040

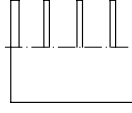

88041

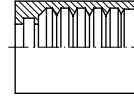

ZSCC2112

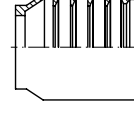

ZAC68010

Pipe fittings

Pipe fittings II

Adaptors

Welding fittings

Industrial fittings

Accessories

Control components

Flow measuring

Trtle LOK

Conexiones Reusables

Reusable series

Embouts série récupérable

Serie Recuperabile

- Casquillos reusables / Crimping ferrules / Jupes à sertir / Boccole a pressare

73

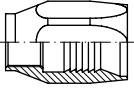

Z1G...R1T

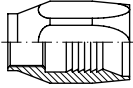

Z1G...R2T

- Conexiones BSP / Reusable BSP / Récuperables BSP / Raccordi recuperabili BSP

73

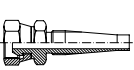

Z3G

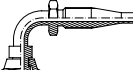

Z90G

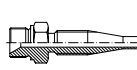

Z2G

- Conexiones JIC 37° / Reusable JIC 37° / Récuperables JIC 37° / Raccordi recuperabili JIC

74

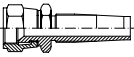

Z3J

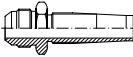

Z2J

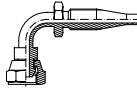

Z3J90



Z3J45

- Conexiones NPT / Reusable NPT / Récuperables NPT / Raccordi recuperabili NPT

74

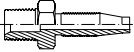

Z2NPT

- Conexiones Métricas / Reusable Metric / Récuperables Métriques / Raccordi recuperabili Metrici

74

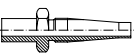

ZE

- Conexiones R5 / Reusable R5 / Récuperables R5 / Raccordi recuperabili R5

75

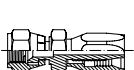

Z3J...R5

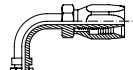

Z3J90...R5

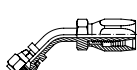

Z2P...R5

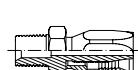

Z3J45...R5

Conexiones Push-On

Push-On Fittings
 Embouts Push-On
 Raccordi Serie Push-On

Pipe fittings

- Conexiones Push-On BSP / Push-on BSP fittings / Embouts Push-on BSP / Raccordi Serie Push-on BSP | 76

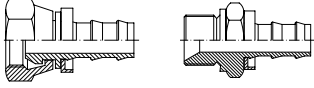

89100

89112

Pipe fittings II

- Conexiones Push-On JIC 37° / Push-on 37° JIC fittings / Embouts Push-on JIC 37° / Raccordi Serie Push-on JIC 37° | 76

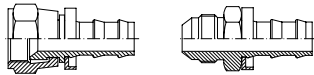

89142

89140

Adaptors

- Conexiones Push-On NPT / Push-on NPT fittings / Embouts Push-on NPT / Raccordi Serie Push-on NPT | 76

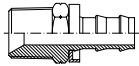

89161

Welding fittings

- Conexiones Push-On Métricas DIN 2383 / Push-on Metric fittings / Embouts Push-on Métriques / Raccordi Serie Push-on Metrici | 76

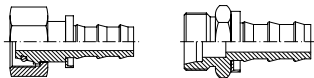

89804

89203

Industrial fittings

Accessories

Control components

Flow measuring

Trazle LOK

Conexiones Alta Presión (700 bar)

High pressure 700 bar fittings

Embouts haute pression 700 bar

Raccordi Altissima pressione (700 bar)

- Casquillos para prensar / Ferrules / Jupes à sertir / Boccole | 77

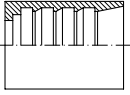

Z71012

- Conexiones BSP / BSP Fittings / Embouts BSP / Raccordi BSP | 77

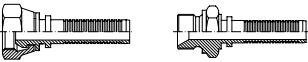

Z74100

Z74112

- Conexiones NPSM - NPT / NPSM - NPT Fittings / Embouts NPSM - NPT / Raccordi NPSM - NPT | 77

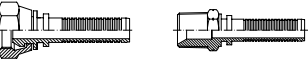

Z74261

Z74161

- Conexiones JIC 37° / JIC 37° Fittings / Embouts JIC 37° / Raccordi JIC 37° | 77



Z74142

Z74140

- Conexiones Métricas / Metric Fittings / Embouts métriques / Raccordi Metrici | 78

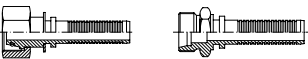

Z74804

Z74203

Conexiones Standard

Standard series
Embouts série standard
Serie Standard

Casquillos R1AT/R2AT/ 1SN/2SN/ R16/2SC/3TE

Ferrules R1AT/R2AT/1SN/2SN/R16/2SC/3TE

Jupes R1AT/R2AT/1SN/2SN/R16/2SC/3TE

Boccole pressare per R1AT/R2AT/1SN/2SN/ R16/2SC/3TE

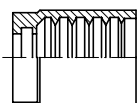

DN	Part nº Referencia	€
3/16"-R1AT	810200300	10,85
3/16"-R2AT	810300300	10,60
1/4"	ZPF221200400	7,52
5/16"	ZPF221200500	8,43
3/8"	ZPF221200600	9,50
1/2"	ZPF221200800	11,24
5/8"	ZPF221201000	14,26
3/4"	ZPF221201200	19,79
1"	ZPF221201600	30,70
1"1/4	ZPF221202000	52,58
1"1/2	ZPF221202400	65,56
2"	ZPF221203200	96,57

Casquillos R1A-1ST

Ferrules R1A-1ST

Jupes R1A-1ST

Boccole pressare per R1A-1ST

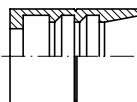

DN	Part nº Referencia	€
3/16"	820030300	9,97
1/4"	820030400	9,24
5/16"	820030500	9,63
3/8"	820030600	10,89
1/2"	820030800	13,32
5/8"	820031000	16,18
3/4"	820031200	20,29
1"	820031600	28,10
1"1/4	820032000	47,99
1"1/2	820032400	67,48
2"	820033200	97,20

Casquillos 1SC/1SN/2SC/R6/2TE

Ferrules 1SC/1SN/2SC/R6/2TE

Jupes 1SC/1SN/2SC/R6/2TE

Boccole pressare per 1SC/1SN/2SC/R6/2TE

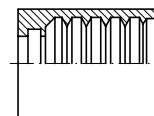

DN	Part nº Referencia	€
1/4"	ZSC21120400	9,20
5/16"	ZSC21120500	11,31
3/8"	ZSC21120600	11,41
1/2"	ZSC21120800	12,06
5/8"	ZSC21121000	15,79
3/4"	ZSC21121200	23,85
1"	ZSC21121600	33,38

Casquillos R2A-2ST/4SP-R9R / R12

Ferrules R2A-2ST/4SP-R9R / R12

Jupes R2A-2ST/4SP-R9R / R12

Boccole pressare per R2A-2ST/4SP-R9R / R12

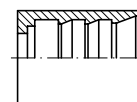

DN	Part nº Referencia	€
3/16" - R2A	820060300	9,16
1/4"	ZPF122400400	9,51
5/16"	ZPF122400500	10,14
3/8"	ZPF122400600	9,57
1/2"	ZPF122400800	11,25
5/8"	ZPF122401000	16,48
3/4"	ZPF122401200	19,91
1"	ZPF122401600	31,04
1"1/4	ZPF122402000	52,03
1"1/2	ZPF122402400	67,76
2"	ZPF122403200	105,54

Casquillos 3SP/4SP/R12/4SH no pelar

Ferrules 3SP/4SP/R12/4SH non skive

Jupes 3SP/4SP/R12/4SH sans dénudage

Boccole pressare per 3SP/4SP/R12/4SH senza spellatura

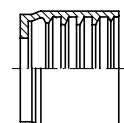

DN	Part nº Referencia	€
3/8"	ZPF222400600	10,42
1/2"	ZPF222400800	12,21
5/8"	ZPF222401000	17,88
3/4"	ZPF222401200	21,60
1"	ZPF222401600	33,68
1" 1/4	ZPF222402000	56,45

■ **CASQUILLO:** Reduce costes y tiempo de montaje

■ **FERRULES:** Simplify assembly and save money

NO PELAR | NO SKIVING

3SP | 4SP | R12 | 4SH

ESPIGA STANDARD | STANDARD SERIES



Consulta en nuestra ficha técnica datos | Check our technical sheet for data

Conexiones Standard

Standard series
Embouts série standard
Serie Standard

Casquillos R7/R8 y elastómero malla metálica / R6

Ferrules R7/R8 and metallic braid / R6

Jupes R7/R8 et tresse métallique / R6

Boccole pressare per R7/R8 e elastomero treccia metallica / R6

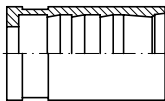

DN	Part n° Referencia	€
1/8"	810140200	7,49
3/16"	810140300	7,21
1/4"	810140400	7,12
5/16"	810140500	7,30
3/8"	810140600	8,22
1/2"	810140800	10,34
5/8"	810141000	16,58
3/4"	810141200	15,78
1"	810141600	25,04

Casquillos PTFE Liso

Ferrules for smooth PTFE

Jupes PTFE lisse

Boccole pressare per PTFE liscio

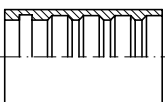

DN	Part n° Referencia	€
1/8"	810400100	7,91
3/16"	810400300	7,61
1/4"	810400400	6,22
5/16"	810400500	7,60
3/8"	810400600	6,55
1/2"	810400800	8,29
5/8"	810401000	11,02
3/4"	810401200	12,37
1"	810401600	20,17

Casquillos PTFE Corrugado

Ferrules for convoluted PTFE

Jupes PTFE convoluté

Boccole pressare per PTFE corrugato

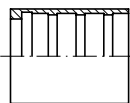

DN	Part n° Referencia	€
1/4"	810410400	7,69
5/16"	810410500	7,81
3/8"	810410600	8,06
1/2"	810410800	9,14
5/8"	810411000	13,77
3/4"	810411201	17,09
1"	810411600	24,26
1"1/4	810412000	36,66
1"1/2	810412400	51,05
2"	810413200	81,70
2"1/2	810414000	113,62

Casquillos para mangueras Ecology y limpieza de alcantarillas

Ferrules for Ecology hose and Sewer Jetting hose

Jupes pour tuyau Ecology et tuyau Hydrocurage

Boccole pressare per tubi Ecology e pulizia fossa biologica

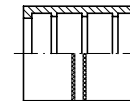

DN	Part n° Referencia	€
3/4"	Z212001200	33,35
1"	Z212001600	45,16
1"1/4	Z212002000	69,08

Casquillos R4

Ferrules R4

Jupes R4

Boccole pressare per R4

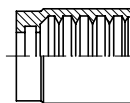

DN	Part n° Referencia	€
3/4"	ZPF221201200R4	25,74

Para otros tamaños, consultar tabla de prensado en nuestra web. / For other sizes, please check out the crimping table on our website. / Pour les autres dimensions, voir tableau de sertissage disponible sur notre site web. / Per altre dimensioni, vedere tabella di pressatura nel ns. sito web

Casquillos PTFE Liso doble malla

Ferrules for double braid smooth PTFE

Jupes PTFE lisse double tresse

Boccole pressare per PTFE liscio doppia treccia

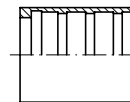

DN	Part n° Referencia	€
1/4"	810450400	8,46
3/8"	810450600	11,08

Para otros tamaños, consultar tabla de prensado en nuestra web. / For other sizes, please check out the crimping table on our website. / Pour les autres dimensions, voir tableau de sertissage disponible sur notre site web. / Per altre dimensioni, vedere tabella di pressatura nel ns. sito web

Conexiones Standard

Standard series

Embouts série standard

Serie Standard

Hembras giratorias rectas rosca BSP cono 60°

BSP Swivel female 60° cone

Femelle gaz cylindrique BSP 60°

Femmina diritta BSP sede 60°

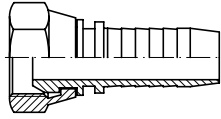

DN	THREAD ROSCA	Part n° Referencia	€
3.2 mm	1/8" BSP	841000201	15,98
1/8"	1/8" BSP	841000202	15,37
3/16"	1/8" BSP	841000203	12,70
1/4"	1/8" BSP	841000204	12,73
3/16"	1/4" BSP	841000403	11,62
1/4"	1/4" BSP	841000404	9,06
5/16"	1/4" BSP	841000405	12,11
3/8"	1/4" BSP	841000406	14,66
1/4"	3/8" BSP	841000604	13,79
5/16"	3/8" BSP	841000605	13,31
3/8"	3/8" BSP	841000606	11,32
1/2"	3/8" BSP	841000608	13,41
3/8"	1/2" BSP	841000806	15,47
1/2"	1/2" BSP	841000808	14,02
5/8"	1/2" BSP	841000810	24,54
1/2"	5/8" BSP	841001008	25,73
5/8"	5/8" BSP	841001010	29,35
1/2"	3/4" BSP	841001208	26,85
5/8"	3/4" BSP	841001210	24,20
3/4"	3/4" BSP	841001212	22,47
3/4"	1" BSP	841001612	39,10
1"	1" BSP	841001616	37,72
1"	1"1/4 BSP	841002016	69,02
1"1/4"	1"1/4 BSP	841002020	73,38
1"1/4"	1"1/2 BSP	841002420	96,60
1"1/2"	1"1/2 BSP	841002424	85,49
1"1/2"	2" BSP	841003224	166,32
2"	2" BSP	841003232	142,27

Hembras giratorias rectas rosca BSP cono 60° con junta tórica

BSP Swivel female 60° cone with o-ring

Femelle gaz cylindrique BSP 60° avec o-ring

Femmina diritta BSP sede 60° con o'ring

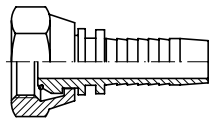

DN	THREAD ROSCA	Part n° Referencia	€
1/4"	1/4" BSP	841100404	12,55
3/8"	3/8" BSP	841100606	14,20
3/8"	1/2" BSP	841100806	22,79
1/2"	1/2" BSP	841100808	16,62
1/2"	3/4" BSP	841101208	31,47
5/8"	3/4" BSP	841101210	29,51
3/4"	3/4" BSP	841101212	23,92
1"	1" BSP	841101616	44,30
1"1/4"	1"1/4 BSP	841102020	70,41
1"1/2"	1"1/2 BSP	841102424	102,24
2"	2" BSP	841103232	173,77

Hembras giratorias rectas rosca BSP asiento plano

BSP Swivel female flat seat

Femelle fond plat BSP

Femmina BSP sede piana

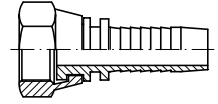

DN	THREAD ROSCA	Part n° Referencia	€
1/4"	1/4" BSP	842000404	10,59
1/4"	3/8" BSP	842000604	19,95
5/16"	3/8" BSP	842000605	17,51
3/8"	3/8" BSP	842000606	12,58
1/2"	3/8" BSP	842000608	21,05
1/4"	1/2" BSP	842000804	32,39
3/8"	1/2" BSP	842000806	19,92
1/2"	1/2" BSP	842000808	16,08
1/2"	3/4" BSP	842001208	30,11
5/8"	3/4" BSP	842001210	28,79
3/4"	3/4" BSP	842001212	24,24
3/4"	1" BSP	842001612	40,96
1"	1" BSP	842001616	40,74
1"	1" 1/4 BSP	842002016	75,93
1"1/4"	1"1/4 BSP	842002020	71,20
1"1/2"	1"1/2 BSP	842002424	94,04
2"	2" BSP	842003232	156,50

Hembras giratorias recta rosca BSP cono 60° doble hexagonal

Double hexagonal BSP Swivel female cone 60°

Femelle BSP cone 60° double hexagonal

Femmina diritta BSP sede 60° doppio esagono

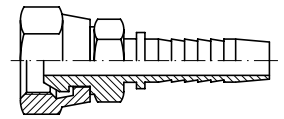

DN	THREAD ROSCA	Part n° Referencia	€
1/4"	1/4" BSP	844000404	20,90
5/16"	3/8" BSP	844000605	21,63
3/8"	3/8" BSP	844000606	21,49
1/2"	1/2" BSP	844000808	23,92
3/4"	3/4" BSP	844001212	38,97
1"	1" BSP	844001616	62,00
1"1/4"	1"1/4 BSP	844002020	83,43
1"1/2"	1"1/2 BSP	844002424	130,45
2"	2" BSP	844003232	226,93

Conexiones Standard

Standard series

Embouts série standard

Serie Standard

Hembras giratorias 90° rosca BSP cono 60°

BSP Swivel female 60° cone (90° Elbow)

Coude 90° femelle gaz cyl. BSP 60°

Femmina 90° BSP sede 60°

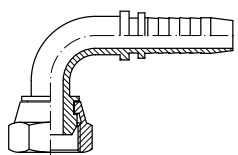

DN	THREAD ROSCA	Part nº Referencia	€
3/16"	1/8" BSP	841070203 *	30,66
3/16"	1/4" BSP	841070403	24,06
1/4"	1/4" BSP	841070404	18,93
5/16"	1/4" BSP	841070405 *	38,86
1/4"	3/8" BSP	841070604	27,03
5/16"	3/8" BSP	841070605	27,56
3/8"	3/8" BSP	841070606	21,17
1/4"	1/2" BSP	841070804	42,02
3/8"	1/2" BSP	841070806	32,40
1/2"	1/2" BSP	841070808	27,17
5/8"	5/8" BSP	841071010	48,62
1/2"	3/4" BSP	841071208	48,59
5/8"	3/4" BSP	841071210	53,16
3/4"	3/4" BSP	841071212	45,33
3/4"	1" BSP	841071612	67,38
1"	1" BSP	841071616	66,72
1"	1" 1/4 BSP	841072016	124,24
1" 1/4"	1" 1/4 BSP	841072020	122,40
1" 1/2"	1" 1/2 BSP	841072424	164,43
2"	2" BSP	841073232	310,62

*Pieza soldada / *Welded piece / *Pièce soudé / *Tipo saldato

Hembras giratorias 90° rosca BSP asiento plano

BSP Swivel female flat seat (90° Elbow)

Coude 90° femelle fond plat BSP

Femmina 90° BSP sede piana

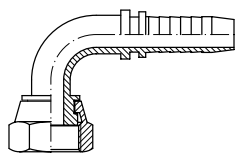

DN	THREAD ROSCA	Part nº Referencia	€
1/4"	1/4" BSP	842070404	25,82
5/16"	3/8" BSP	842070605	31,17
3/8"	3/8" BSP	842070606	28,68
1/2"	1/2" BSP	842070808	34,34
3/4"	3/4" BSP	842071212	49,40
3/4"	1" BSP	842071612	80,51
1"	1" BSP	842071616	77,05
1" 1/4"	1" 1/4 BSP	842072020	152,53
1" 1/2"	1" 1/2 BSP	842072424	175,85
2"	2" BSP	842073232	396,51

Hembras giratorias 45° rosca BSP cono 60°

BSP Swivel female 60° cone (45° Elbow)

Coude 45° femelle gaz cyl. BSP 60°

Femmina 45° BSP sede 60°

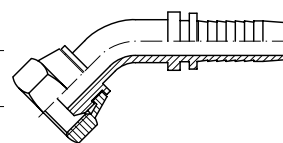

DN	THREAD ROSCA	Part nº Referencia	€
3/16"	1/4" BSP	841080403	24,06
1/4"	1/4" BSP	841080404	18,93
1/4"	3/8" BSP	841080604	27,03
5/16"	3/8" BSP	841080605	27,56
3/8"	3/8" BSP	841080606	21,17
1/4"	1/2" BSP	841080804	42,02
3/8"	1/2" BSP	841080806	32,40
1/2"	1/2" BSP	841080808	27,17
5/8"	5/8" BSP	841081010	48,62
1/2"	3/4" BSP	841081208	48,59
5/8"	3/4" BSP	841081210	53,16
3/4"	3/4" BSP	841081212	45,33
3/4"	1" BSP	841081612	67,38
1"	1" BSP	841081616	66,72
1"	1" 1/4 BSP	841082016	124,24
1" 1/4"	1" 1/4 BSP	841082020	122,40
1" 1/2"	1" 1/2 BSP	841082424	164,43
2"	2" BSP	841083232	310,62

Hembras giratorias 45° rosca BSP asiento plano

BSP Swivel female flat seat (45° Elbow)

Coude 45° femelle fond plat BSP

Femmina 45° BSP sede piana

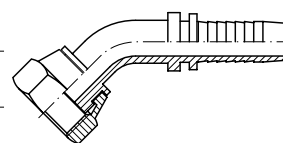

DN	THREAD ROSCA	Part nº Referencia	€
1/4"	1/4" BSP	842080404	25,82
5/16"	3/8" BSP	842080605	31,17
3/8"	3/8" BSP	842080606	28,68
3/8"	1/2" BSP	842080806	38,63
1/2"	1/2" BSP	842080808	34,34
3/4"	3/4" BSP	842081212	49,40
3/4"	1" BSP	842081612	80,51
1"	1" BSP	842081616	77,05
1" 1/4"	1" 1/4 BSP	842082020	152,53
1" 1/2"	1" 1/2 BSP	842082424	175,85
2"	2" BSP	842083232	396,51

Hembras giratorias 90° compactas rosca BSP cono 60°

BSP swivel female 60° (90° Compact Elbow)

Femelle coudé 90° compact BSP cone 60°

Femmina 90° BSP compatta

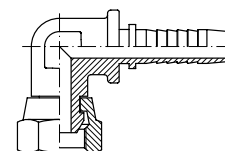

DN	THREAD ROSCA	Part nº Referencia	€
1/4"	1/4" BSP	841270404	47,58
3/8"	3/8" BSP	841270606	49,73
1/2"	1/2" BSP	841270808	77,17
3/4"	3/4" BSP	841271212	96,65
1"	1" BSP	841271616	140,92

Conexiones Standard

Standard series
Embouts série standard
Serie Standard

Hembras giratorias 90° rosca BSP cono 60° con junta tórica

BSP Swivel female 60° cone with o-ring (90° Elbow)

Coûde 90° femelle gaz cyl. BSP 60° avec o-ring

Femmina 90° BSP sede 60° con o'ring

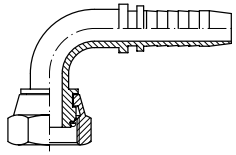

DN	THREAD ROSCA	Part n° Referencia	€
1/4"	1/4" BSP	841170404	26,81
3/8"	3/8" BSP	841170606	31,40
3/8"	1/2" BSP	841170806	41,12
1/2"	1/2" BSP	841170808	35,71
1/2"	3/4" BSP	841171208	62,71
5/8"	3/4" BSP	841171210	53,30
3/4"	3/4" BSP	841171212	50,88
1"	1" BSP	841171616	80,16
1"1/4"	1"1/4 BSP	841172020	140,09
1"1/2"	1"1/2 BSP	841172424	188,35
2"	2" BSP	841173232	423,95

Hembras giratorias 45° rosca BSP cono 60° con junta tórica

BSP Swivel female 60° cone with o-ring (45° Elbow)

Coûde 45° femelle gaz cyl. BSP 60° avec o-ring

Femmina 45° BSP sede 60° con o'ring

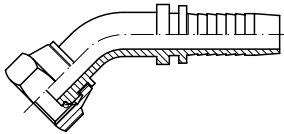

DN	THREAD ROSCA	Part n° Referencia	€
1/4"	1/4" BSP	841180404	26,81
3/8"	3/8" BSP	841180606	31,40
3/8"	1/2" BSP	841180806	41,12
1/2"	1/2" BSP	841180808	35,71
1/2"	3/4" BSP	841181208	62,71
5/8"	3/4" BSP	841181210	53,30
3/4"	3/4" BSP	841181212	50,88
1"	1" BSP	841181616	80,16
1"1/4"	1"1/4 BSP	841182020	140,09
1"1/2"	1"1/2 BSP	841182424	188,35
2"	2" BSP	841183232	423,95

Machos rosca cilíndrica BSP asiento plano

BSP Male flat seat

Mâle BSP fond plat

Maschio BSP sede piana

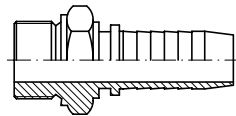

DN	THREAD ROSCA	Part n° Referencia	€
3/16"	1/4" BSP	842120403	20,70
1/4"	1/4" BSP	842120404	14,46
5/16"	3/8" BSP	842120605	21,28
3/8"	3/8" BSP	842120606	17,27
3/8"	1/2" BSP	842120806	23,42
1/2"	1/2" BSP	842120808	19,26
5/8"	5/8" BSP	842121010	33,84
3/4"	3/4" BSP	842121212	25,86
3/4"	1" BSP	842121612	51,21
1"	1" BSP	842121616	46,66
1"	1" 1/4 BSP	842122016	96,17
1"1/4"	1"1/4 BSP	842122020	87,79
1"1/2"	1"1/2 BSP	842122424	120,87
2"	2" BSP	842123232	155,67

Machos rosca cilíndrica BSP cono 60°

BSP Male-parallel 60° cone

Mâle BSP cône 60°

Maschio BSP cilindrico sede 60°

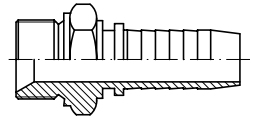

DN	THREAD ROSCA	Part n° Referencia	€
1/4"	1/8" BSP	841120204	20,54
3/16"	1/4" BSP	841120403	20,70
1/4"	1/4" BSP	841120404	12,32
3/8"	1/4" BSP	841120406	21,93
1/4"	3/8" BSP	841120604	23,17
5/16"	3/8" BSP	841120605	17,05
3/8"	3/8" BSP	841120606	13,12
3/8"	1/2" BSP	841120806	17,98
1/2"	1/2" BSP	841120808	16,85
5/8"	5/8" BSP	841121010	33,42
5/8"	3/4" BSP	841121210	29,74
3/4"	3/4" BSP	841121212	24,54
3/4"	1" BSP	841121612	50,48
1"	1" BSP	841121616	47,12
1"	1"1/4 BSP	841122016	84,80
1"1/4"	1"1/4 BSP	841122020	80,49
1"1/4"	1"1/2 BSP	841122420	102,13
1"1/2"	1"1/2 BSP	841122424	95,61
2"	2" BSP	841123232	154,13

Macho rosca cónica BSPT cono 60°

Male BSPT tapered

Mâle gaz conique BSPT 60°

Maschio BSPT conico

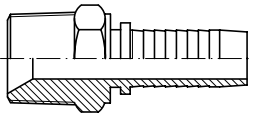

DN	THREAD ROSCA	Part n° Referencia	€
1/4"	1/4" BSPT	841140404	10,73
5/16"	1/4" BSPT	841140405	17,70
3/8"	1/4" BSPT	841140406	18,00
1/4"	3/8" BSPT	841140604	20,31
5/16"	3/8" BSPT	841140605	18,78
3/8"	3/8" BSPT	841140606	14,11
1/2"	3/8" BSPT	841140608	19,39
3/8"	1/2" BSPT	841140806	23,72
1/2"	1/2" BSPT	841140808	15,76
5/8"	1/2" BSPT	841140810	27,38
1/2"	3/4" BSPT	841141208	28,77
5/8"	3/4" BSPT	841141210	26,61
3/4"	3/4" BSPT	841141212	23,57
3/4"	1" BSPT	841141612	40,79
1"	1" BSPT	841141616	38,95
1"	1"1/4 BSPT	841142016	77,68
1"1/4"	1"1/4 BSPT	841142020	69,78
1"1/4"	1"1/2 BSPT	841142420	103,06
1"1/2"	1"1/2 BSPT	841142424	86,11
2"	2" BSPT	841143232	144,39

Conexiones Standard

Standard series
Embouts série standard
Serie Standard

Machos O'Ring Boss

O'Ring Boss Male

Mâle O'Ring Boss

Maschio O'Ring Boss

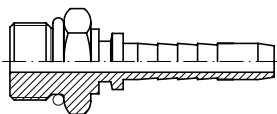

DN	THREAD ROSCA	Part n° Referencia	€
1/4"	7/16"-20h UNF	847120604	16,88
3/8"	9/16"-18h UNF	847121006	17,12
1/2"	3/4"-16h UNF	847121208	19,82
5/8"	7/8"-14h UNF	847121610	24,65
3/4"	1"1/16-12h UN	847122012	49,43
1"	1"5/16-12h UN	847122516	82,78

Juntas para hembra giratoria BSP FKM verde

O'ring for swivel female BSP FKM green

Joint torique pour femelle tournante BSP FKM vert

Guarnizione per femmina girevole BSP FKM verde

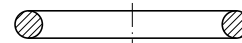

THREAD ROSCA	Part n° Referencia	€
1/4" BSP	JTVBSP04	0,17
3/8" BSP	JTVBSP06	0,18
1/2" BSP	JTVBSP08	0,19
5/8" BSP	JTVBSP10	0,19
3/4" BSP	JTVBSP12	0,22
1" BSP	JTVBSP16	0,30
1"1/4 BSP	JTVBSP20	0,45
1"1/2 BSP	JTVBSP24	0,58
2" BSP	JTVBSP32	0,84

Conexiones Standard

Standard series
Embouts série standard
Serie Standard

Pipe fittings

Pipe fittings II

Adaptors

Welding fittings

Industrial fittings

Accessories

Control components

Flow measuring

Tralle LOK

Hembras giratorias rectas rosca NPSM cono 60° doble hexagonal

Double hexagonal NPSM Swivel female cone 60°

Femelle NPSM cone 60° double hexagonal

Femmina diritta NPSM sede 60° doppio esagono

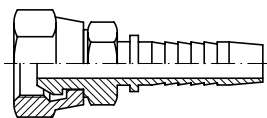

DN	THREAD ROSCA	Part n° Referencia	€
1/4"	1/4" 18h NPSM	843610404	26,28
3/8"	3/8" 18h NPSM	843610606	27,07
1/2"	1/2" 14h NPSM	843610808	29,93
3/4"	3/4" 14h NPSM	843611212	43,64
1"	1" - 11 1/2h NPSM	843611616	69,44

Hembras giratorias rectas rosca NPSM cono 60°

NPSM Swivel female 60° cone

Femelle NPSM cone 60°

Femmina diritta NPSM sede 60°

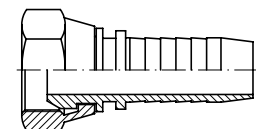

DN	THREAD ROSCA	Part n° Referencia	€
1/4"	1/4" 18h NPSM	842610404	13,83
3/8"	3/8" 18h NPSM	842610606	14,39
1/2"	1/2" 14h NPSM	842610808	19,07
3/4"	3/4" 14h NPSM	842611212	29,09
3/4"	1"-11 1/2h NPSM	842611612	47,36
1"	1"-11 1/2h NPSM	842611616	45,98
1"1/2"	1"1/2-11 1/2h NPSM	842612424	97,20

Hembras giratorias 90° rosca NPSM cono 60°

NPSM Swivel female 60° cone (90° Elbow)

Coude 90° femelle NPSM cone 60°

Femmina 90° NPSM sede 60°

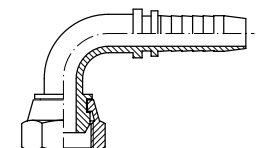

DN	THREAD ROSCA	Part n° Referencia	€
1/4"	1/4" 18h NPSM	842620404	23,64
3/8"	3/8" 18h NPSM	842620606	25,60
1/2"	1/2" 14h NPSM	842620808	33,18
3/4"	3/4" 14h NPSM	842621212	57,63
1"	1"-11 1/2h NPSM	842621616	78,00

Hembras giratorias 45° rosca NPSM cono 60°

NPSM Swivel female 60° cone (45° Elbow)

Coude 45° femelle NPSM cone 60°

Femmina 45° NPSM sede 60°

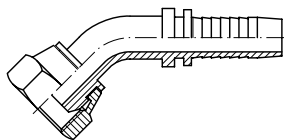

DN	THREAD ROSCA	Part n° Referencia	€
1/4"	1/4" 18h NPSM	842630404	23,64
3/8"	3/8" 18h NPSM	842630606	25,60
1/2"	1/2" 14h NPSM	842630808	33,18
3/4"	3/4" 14h NPSM	842631212	57,63
1"	1"-11 1/2h NPSM	842631616	78,00

Machos rosca cónica NPT

NPT Male pipe straight

Embout mâle conique NPT (BRIGGS)

Maschio NPT conico

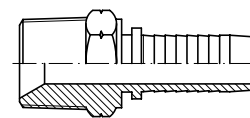

DN	THREAD ROSCA	Part n° Referencia	€
1/4"	1/8" NPT	841610204	17,43
3/16"	1/4" NPT	841610403	16,54
1/4"	1/4" NPT	841610404	11,36
5/16"	1/4" NPT	841610405	18,06
3/8"	1/4" NPT	841610406	18,34
1/4"	3/8" NPT	841610604	17,94
5/16"	3/8" NPT	841610605	18,93
3/8"	3/8" NPT	841610606	12,31
1/2"	3/8" NPT	841610608	22,88
1/4"	1/2" NPT	841610804	23,60
3/8"	1/2" NPT	841610806	26,68
1/2"	1/2" NPT	841610808	17,38
5/8"	1/2" NPT	841610810	21,94
1/2"	3/4" NPT	841611208	27,86
5/8"	3/4" NPT	841611210	29,69
3/4"	3/4" NPT	841611212	23,63
3/4"	1" NPT	841611612	44,47
1"	1" NPT	841611616	39,99
1"	1"1/4 NPT	841612016	75,08
1"1/4"	1"1/4 NPT	841612020	73,58
1"1/4"	1"1/2 NPT	841612420	95,09
1"1/2"	1"1/2 NPT	841612424	88,44
2"	2" NPT	841613232	146,56

Machos giratorios NPT

Swivel male NPT

Mâle tournant NPT

Maschio girevole NPT

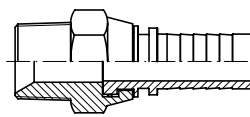

DN	THREAD ROSCA	Part n° Referencia	€
1/4"	1/4" NPT	841650404	42,46
3/8"	3/8" NPT	841650606	45,50
1/2"	1/2" NPT	841650808	49,46
3/4"	3/4" NPT	841651212	71,01
3/4"	1" NPT	841651612	112,62
1"	1" NPT	841651616	105,19

Conexiones Standard

Standard series

Embouts série standard

Serie Standard

Hembras giratorias recta JIC 37° doble hexagonal

Double hexagonal JIC 37° Swivel female

Femelle JIC 37° double hexagonal

Femmina diritta JIC 37° doppio esagono

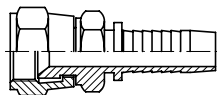

DN	THREAD ROSCA	Part n° Referencia	€
3/16"	7/16" 20h UNF	842420703	16,98
1/4"	7/16" 20h UNF	842420704	15,28
5/16"	7/16" 20h UNF	842420705	17,79
1/4"	1/2" 20h UNF	842420804	19,96
3/8"	1/2" 20h UNF	842420806	23,75
5/16"	9/16" 18h UNF	842420905	25,00
3/8"	9/16" 18h UNF	842420906	16,82
3/8"	3/4" 16h UNF	842421206	22,20
1/2"	3/4" 16h UNF	842421208	18,32
5/8"	3/4" 16h UNF	842421210	26,64
1/2"	7/8" 14h UNF	842421408	31,12
5/8"	7/8" 14h UNF	842421410	33,81
3/4"	7/8" 14h UNF	842421412	36,51
5/8"	1"1/16 12h UN	842421710	35,18
3/4"	1"1/16 12h UN	842421712	33,08
1"	1"1/16 12h UN	842421716	55,40
3/4"	1"5/16 12h UN	842422112	51,97
1"	1"5/16 12h UN	842422116	50,86
1"1/4"	1"5/8 12h UN	842422620	103,83
1"1/2"	1"7/8 12h UN	842423024	134,86
2"	2"1/2 12h UN	842424032	260,45

Hembras giratorias recta JIC 37°

JIC 37° Swivel female

Femelle droite JIC cone 37°

Femmina diritta JIC sede 37°

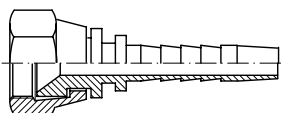

DN	THREAD ROSCA	Part n° Referencia	€
3.2 mm	7/16" 20h UNF	841420701	16,46
3/16"	7/16" 20h UNF	841420703	13,10
1/4"	7/16" 20h UNF	841420704	11,02
3/16"	1/2" 20h UNF	841420803	15,11
1/4"	1/2" 20h UNF	841420804	12,20
5/16"	1/2" 20h UNF	841420805	13,55
1/4"	9/16" 18h UNF	841420904	13,63
5/16"	9/16" 18h UNF	841420905	12,57
3/8"	9/16" 18h UNF	841420906	12,94
3/8"	3/4" 16h UNF	841421206	15,80
1/2"	3/4" 16h UNF	841421208	16,12
3/8"	7/8" 14h UNF	841421406	20,86
1/2"	7/8" 14h UNF	841421408	17,92
5/8"	7/8" 14h UNF	841421410	21,51
1/2"	1"1/16 12h UN	841421708	36,36
5/8"	1"1/16 12h UN	841421710	28,93
3/4"	1"1/16 12h UN	841421712	23,93
1"	1"1/16 12h UN	841421716	36,12
3/4"	1"5/16 12h UN	841422112	36,17
1"	1"5/16 12h UN	841422116	39,66
1"	1"5/8 12h UN	841422616	61,23
1"1/4"	1"5/8 12h UN	841422620	67,03
1" 1/4	1"7/8 12h UN	841423020	130,26
1"1/2	1"7/8 12h UN	841423024	100,78
2"	2"1/2 12h UN	841424032	186,80

Hembras giratorias 90° JIC 37°

JIC 37° Swivel female (90° Elbow)

Coude 90° femelle JIC cone 37°

Femmina 90° JIC sede 37°

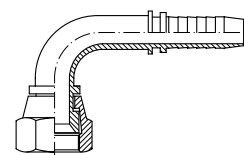

DN	THREAD ROSCA	Part n° Referencia	€
3/16"	7/16" 20h UNF	841380703	26,68
1/4"	7/16" 20h UNF	841380704	20,00
1/4"	1/2" 20h UNF	841380804	23,50
5/16"	1/2" 20h UNF	841380805	30,73
1/4"	9/16" 18h UNF	841380904	34,14
5/16"	9/16" 18h UNF	841380905	26,10
3/8"	9/16" 18h UNF	841380906	24,89
3/8"	3/4" 16h UNF	841381206	31,11
1/2"	3/4" 16h UNF	841381208	27,02
3/8"	7/8" 14h UNF	841381406	36,74
1/2"	7/8" 14h UNF	841381408	32,32
5/8"	7/8" 14h UNF	841381410	38,51
5/8"	1"1/16 12h UN	841381710	44,49
3/4"	1"1/16 12h UN	841381712	47,51
3/4"	1" 5/16 12h UN	841382112	71,86
1"	1"5/16 12h UN	841382116	73,02
1"	1"5/8 12h UN	841382616	142,85
1"1/4"	1"5/8 12h UN	841382620	127,74
1" 1/4	1"7/8 12h UN	841383020	208,31
1"1/2	1"7/8 12h UN	841383024	193,56
2"	2"1/2 12h UN	841384032	466,99

Hembras giratorias 45° JIC 37°

JIC 37° Swivel female (45° Elbow)

Coude 45° femelle JIC cone 37°

Femmina 45° JIC sede 37°

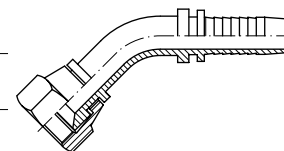

DN	THREAD ROSCA	Part n° Referencia	€
3/16"	7/16" 20h UNF	841390703	26,68
1/4"	7/16" 20h UNF	841390704	20,00
1/4"	1/2" 20h UNF	841390804	23,50
5/16"	1/2" 20h UNF	841390805	30,73
1/4"	9/16" 18h UNF	841390904	34,14
5/16"	9/16" 18h UNF	841390905	26,10
3/8"	9/16" 18h UNF	841390906	24,89
3/8"	3/4" 16h UNF	841391206	31,11
1/2"	3/4" 16h UNF	841391208	27,02
3/8"	7/8" 14h UNF	841391406	36,74
1/2"	7/8" 14h UNF	841391408	32,32
5/8"	7/8" 14h UNF	841391410	38,51
5/8"	1"1/16 12h UN	841391710	44,49
3/4"	1"1/16 12h UN	841391712	47,51
3/4"	1"5/16 12h UN	841392112	71,86
1"	1"5/16 12h UN	841392116	73,02
1"	1"5/8 12h UN	841392616	142,85
1"1/4"	1"5/8 12h UN	841392620	127,74
1"1/4	1"7/8 12h UN	841393020	208,31
1"1/2	1"7/8 12h UN	841393024	193,56
2"	2"1/2 12h UN	841394032	466,99

Conexiones Standard

Standard series

Embouts série standard

Serie Standard

Machos rosca JIC cono 37°

Male JIC 37°

Mâle fixe JIC cone 37°

Maschio JIC sede 37°

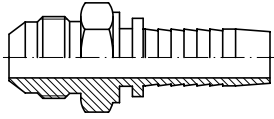

DN	THREAD ROSCA	Part n° Referencia	€
1/4"	7/16" 20h UNF	841400704	15,44
1/4"	1/2" 20h UNF	841400804	16,02
5/16"	1/2" 20h UNF	841400805	16,65
1/4"	9/16" 18h UNF	841400904	18,66
5/16"	9/16" 18h UNF	841400905	22,47
3/8"	9/16" 18h UNF	841400906	19,95
1/4"	3/4" 16h UNF	841401204	33,54
3/8"	3/4" 16h UNF	841401206	16,63
1/2"	3/4" 16h UNF	841401208	18,92
3/8"	7/8" 14h UNF	841401406	25,05
1/2"	7/8" 14h UNF	841401408	18,60
5/8"	7/8" 14h UNF	841401410	24,86
5/8"	1"1/16 12h UN	841401710	33,92
3/4"	1"1/16 12h UN	841401712	28,94
1"	1"1/16 12h UN	841401716	34,38
3/4"	1"5/16 12h UN	841402112	49,38
1"	1"5/16 12h UN	841402116	50,87
1"	1"5/8 12h UN	841402616	82,17
1"1/4	1"5/8 12h UN	841402620	74,46
1"1/2	1"7/8 12h UN	841403024	95,50
2"	2"1/2 12h UN	841404032	215,62

Machos rosca JIC cono 37° con junta

Male JIC 37° with o'ring

Mâle fixe JIC cone 37° avec o'ring

Maschio JIC sede 37° con o'ring

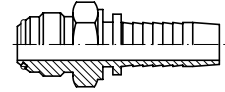

DN	THREAD ROSCA	Part n° Referencia	€
1/4"	7/16" 20h UNF	841410704	18,28
3/8"	9/16" 18h UNF	841410906	20,61
1/2"	3/4" 16h UNF	841411208	25,66
3/4"	1"1/16 12h UN	841411712	47,71
1"	1"5/16 12h UN	841412116	60,23
1"1/4	1"5/8 12h UN	841412620	117,03
1"1/2	1"7/8 12h UN	841413024	149,56
2"	2"1/2 12h UN	841414032	371,30

Hembras giratorias 90° compactas JIC 37°

JIC 37° Swivel female (90° Compact Elbow)

Femelle coudé 90° compact JIC cone 37°

Femmina 90° JIC sede 37° compatta

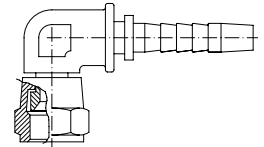

DN	THREAD ROSCA	Part n° Referencia	€
1/4"	7/16" 20h UNF	841370704	53,53
3/8"	9/16" 18h UNF	841370906	55,48
1/2"	3/4" 16h UNF	841371208	62,43
3/4"	1"1/16 12h UNF	841371712	102,46
1"	1"5/16 12h UNF	841372116	140,27

Pipe fittings

Pipe fittings II

Adaptors

Welding fittings

Industrial fittings

Accessories

Control components

Flow measuring

Tralle LOK

Conexiones Standard

Standard series
Embouts série standard
Serie Standard

Hembras giratorias rectas rosca Métrica cono 24° con junta tórica - DKO

Metric female swivel with o'ring 24° cone

Femelle Métrique avec o'ring cône 24°

Femmina Metrica sede 24° con o'ring

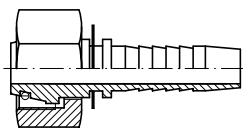

DN	PIPE TUBO	SERIE	THREAD ROSCA	Part nº Referencia	€
3/16"	6	L	M12x1.5	84804120603	13,12
1/4"	6	L	M12x1.5	84804120604	10,85
1/4"	8	L	M14x1.5	84804140804	9,71
5/16"	8	L	M14x1.5	84804140805	12,61
3/8"	8	L	M 14x1.5	84804140806	18,69
3/8"	8	L	M16x1.5	84804160806	15,16
1/4"	10	L	M16x1.5	84804161004	12,28
5/16"	10	L	M16x1.5	84804161005	11,80
3/8"	10	L	M16x1.5	84804161006	12,18
1/4"	12	L	M18x1.5	84804181204	18,94
5/16"	12	L	M18x1.5	84804181205	15,06
3/8"	12	L	M18x1.5	84804181206	11,82
1/2"	12	L	M 18x1.5	84804181208	25,50
1/4"	15	L	M22x1.5	84804221504	21,37
5/16"	15	L	M22x1.5	84804221505	20,82
3/8"	15	L	M22x1.5	84804221506	17,98
1/2"	15	L	M22x1.5	84804221508	17,26
3/8"	18	L	M26x1.5	84804261806	26,29
1/2"	18	L	M26x1.5	84804261808	25,95
5/8"	18	L	M26x1.5	84804261810	23,82
3/4"	18	L	M26x1.5	84804261812	32,30
1/2"	22	L	M30x2	84804302208	34,75
3/4"	22	L	M30x2	84804302212	29,12
3/4"	28	L	M36x2	84804362812	48,44
1"	28	L	M36x2	84804362816	45,53
1"	35	L	M45x2	84804453516	87,52
1 1/4	35	L	M45x2	84804453520	71,97
1 1/4	42	L	M52x2	84804524220	106,60
1 1/2	42	L	M52x2	84804524224	93,91
2"	42	L	M52x2	84804524232	182,70
1/4"	6	S	M14x1.5	84804140604	15,12
1/4"	8	S	M16x1.5	84804160804	13,30
5/16"	8	S	M16x1.5	84804160805	15,29
1/4"	10	S	M18x1.5	84804181004	13,07
5/16"	10	S	M18x1.5	84804181005	19,74
3/8"	10	S	M18x1.5	84804181006	20,73
5/16"	12	S	M20x1.5	84804201205	16,98
3/8"	12	S	M20x1.5	84804201206	14,53
1/2"	12	S	M20x1.5	84804201208	19,90
5/16"	14	S	M22x1.5	84804221405	20,47
3/8"	14	S	M22x1.5	84804221406	18,95
1/4"	16	S	M24x1.5	84804241604	25,87
5/16"	16	S	M24x1.5	84804241605	25,35
3/8"	16	S	M24x1.5	84804241606	23,47
1/2"	16	S	M24x1.5	84804241608	17,06
5/8"	16	S	M24x1.5	84804241610	26,13
1/2"	20	S	M30x2	84804302008	30,87
5/8"	20	S	M30x2	84804302010	24,66
3/4"	20	S	M30x2	84804302012	40,19
5/8"	25	S	M36x2	84804362510	49,43
3/4"	25	S	M36x2	84804362512	45,77
1"	25	S	M36x2	84804362516	55,09
3/4"	30	S	M42x2	84804423012	67,06
1"	30	S	M42x2	84804423016	62,09
1 1/4	38	S	M52x2	84804523820	97,61

Machos rosca Métrica cono 24°

Metric Male stud 24° cone

Mâle métrique cône 24°

Maschio Metrico sede 24°

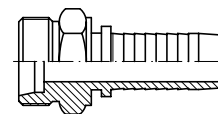

DN	PIPE TUBO	SERIE	THREAD ROSCA	Part nº Referencia	€
1/4"	6	L	M12x1.5	84203120604	19,85
1/4"	8	L	M14x1.5	84203140804	13,79
1/4"	10	L	M16x1.5	84203161004	16,44
5/16"	10	L	M16x1.5	84203161005	20,25
3/8"	10	L	M16x1.5	84203161006	17,22
1/4"	12	L	M18x1.5	84203181204	18,24
5/16"	12	L	M18x1.5	84203181205	17,73
3/8"	12	L	M18x1.5	84203181206	10,88
3/8"	15	L	M22x1.5	84203221506	21,37
1/2"	15	L	M22x1.5	84203221508	17,28
1/2"	18	L	M26x1.5	84203261808	24,56
5/8"	18	L	M26x1.5	84203261810	23,70
3/4"	22	L	M30x2	84203302212	31,38
1"	28	L	M36x2	84203362816	49,19
1 1/4	35	L	M45x2	84203453520	70,04
1 1/2	42	L	M52x2	84203524224	111,90
1/4"	6	S	M14x1.5	84203140604	20,01
1/4"	8	S	M16x1.5	84203160804	16,80
1/4"	10	S	M18x1.5	84203181004	23,48
5/16"	10	S	M18x1.5	84203181005	29,05
3/8"	10	S	M18x1.5	84203181006	20,68
5/16"	12	S	M20x1.5	84203201205	20,34
3/8"	12	S	M20x1.5	84203201206	21,37
3/8"	14	S	M22x1.5	84203221406	25,25
1/2"	14	S	M22x1.5	84203221408	30,97
1/2"	16	S	M24x1.5	84203241608	18,49
5/8"	20	S	M30x2	84203302010	32,20
3/4"	20	S	M30x2	84203302012	33,39
3/4"	25	S	M36x2	84203362512	47,69
1"	25	S	M36x2	84203362516	59,99
1"	30	S	M42x2	84203423016	78,31
1 1/4	38	S	M52x2	84203523820	110,27

Hembras giratorias rectas rosca Métrica cono 24°/60°

Metric female swivel 24°/60° cone

Femelle Métrique cône 24°/60°

Femmina Metrica sede 24°/60°

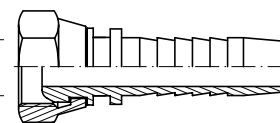

DN	PIPE TUBO	SERIE	THREAD ROSCA	Part nº Referencia	€
1/4"	8	L	M14x1.5	84404140804	13,59
1/4"	10	L	M16x1.5	84404161004	17,19
5/16"	10	L	M16x1.5	84404161005	17,64
3/8"	10	L	M16x1.5	84404161006	17,58
5/16"	12	L	M18x1.5	84404181205	21,08
3/8"	12	L	M18x1.5	84404181206	16,55
3/8"	15	L	M22x1.5	84404221506	25,17
1/2"	15	L	M22x1.5	84404221508	22,39
5/8"	18	L	M26x1.5	84404261810	33,35

Conexiones Standard

Standard series

Embouts série standard

Serie Standard

Hembras giratorias 90° Métricas cono 24° con junta tórica - DKO 90°

Metric swivel female with o'ring 24° cone (90° Elbow)

Coûde 90° femelle Métrique cône 24° avec o'ring

Femmina Metrica 90° sede 24° con o'ring

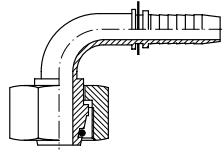

DN	PIPE TUBO	SERIE	THREAD ROSCA	Part nº Referencia	€
3/16"	6	L	M12x1.5	84305120603	26,42
1/4"	6	L	M12x1.5	84305120604	21,53
1/4"	8	L	M14x1.5	84305140804	20,49
5/16"	8	L	M14x1.5	84305140805	21,92
1/4"	10	L	M16x1.5	84305161004	24,02
5/16"	10	L	M16x1.5	84305161005	27,70
3/8"	10	L	M16x1.5	84305161006	26,42
1/4"	12	L	M18x1.5	84305181204	32,90
5/16"	12	L	M18x1.5	84305181205	32,03
3/8"	12	L	M18x1.5	84305181206	24,44
1/2"	12	L	M18x1.5	84305181208	37,54
1/2"	15	L	M22x1.5	84305221508	29,68
1/2"	18	L	M26x1.5	84305261808	47,09
5/8"	18	L	M26x1.5	84305261810	44,24
5/8"	22	L	30x2	84305302210	55,87
3/4"	22	L	M30x2	84305302212	52,80
3/4"	28	L	36x2	84305362812	83,85
1"	28	L	M36x2	84305362816	77,64
1" 1/4	35	L	M45x2	84305453520	130,60
1" 1/2	42	L	M52x2	84305524224	202,58
3/16"	6	S	M14x1.5	84305140603	33,40
1/4"	6	S	M14x1.5	84305140604	25,24
1/4"	8	S	M16x1.5	84305160804	24,89
5/16"	8	S	M16x1.5	84305160805	27,38
1/4"	10	S	M18x1.5	84305181004	25,28
5/16"	10	S	M18x1.5	84305181005	27,55
3/8"	10	S	M18x1.5	84305181006	28,31
5/16"	12	S	M20x1.5	84305201205	32,40
3/8"	12	S	M20x1.5	84305201206	26,73
1/2"	12	S	M20x1.5	84305201208	32,07
3/8"	14	S	M22x1.5	84305221406	37,36
3/8"	16	S	M24x1.5	84305241606	34,96
1/2"	16	S	M24x1.5	84305241608	30,44
3/8"	20	S	M30x2	84305302006	67,94
5/8"	20	S	M30x2	84305302010	53,55
3/4"	20	S	M30x2	84305302012	55,99
3/4"	25	S	M36x2	84305362512	75,35
1"	25	S	M36x2	84305362516	86,73
5/8"	30	S	M42x2	84305423010	115,04
3/4"	30	S	M42x2	84305423012	162,48
1"	30	S	M42x2	84305423016	109,76
1" 1/4	38	S	M52x2	84305523820	175,35

Hembras giratorias 45° Métricas cono 24° con junta tórica - DKO 45°

Metric swivel female with o'ring 24° cone (45° Elbow)

Coûde 45° femelle Métrique cône 24° avec o'ring

Femmina Metrica 45° sede 24° con o'ring

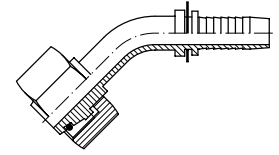

DN	PIPE TUBO	SERIE	THREAD ROSCA	Part nº Referencia	€
3/16"	6	L	M12x1.5	84306120603	26,42
1/4"	6	L	M12x1.5	84306120604	21,53
1/4"	8	L	M14x1.5	84306140804	20,49
5/16"	8	L	M14x1.5	84306140805	21,92
1/4"	10	L	M16x1.5	84306161004	24,02
5/16"	10	L	M16x1.5	84306161005	27,70
3/8"	10	L	M16x1.5	84306161006	26,42
1/4"	12	L	M18x1.5	84306181204	32,90
5/16"	12	L	M18x1.5	84306181205	32,03
3/8"	12	L	M18x1.5	84306181206	24,44
1/2"	12	L	M18x1.5	84306181208	37,54
3/8"	15	L	M22x1.5	84306221506	34,06
1/2"	15	L	M22x1.5	84306221508	29,68
1/2"	18	L	M26x1.5	84306261808	47,09
5/8"	18	L	M26x1.5	84306261810	44,68
5/8"	22	L	M30x2	84306302210	55,87
3/4"	22	L	M30x2	84306302212	52,80
3/4"	28	L	M36x2	84306362812	83,85
1"	28	L	M36x2	84306362816	77,64
1" 1/4	35	L	M45x2	84306453520	130,60
1" 1/2	42	L	M52x2	84306524224	202,58
3/16"	6	S	M14x1.5	84306140604	25,24
1/4"	6	S	M16x1.5	84306160804	24,89
1/4"	8	S	M16x1.5	84306160805	27,38
5/16"	8	S	M18x1.5	84306181004	25,28
1/4"	10	S	M18x1.5	84306181006	28,31
3/8"	10	S	M20x1.5	84306201204	33,83
5/16"	12	S	M20x1.5	84306201205	32,40
3/8"	12	S	M20x1.5	84306201206	26,73
1/2"	12	S	M20x1.5	84306201208	32,07
3/8"	14	S	M22x1.5	84306221406	37,56
1/2"	16	S	M24x1.5	84306241606	34,96
1/2"	16	S	M24x1.5	84306241608	30,44
3/8"	20	S	M30x2	84306302006	67,94
5/8"	20	S	M30x2	84306302010	53,55
3/4"	20	S	M30x2	84306302012	55,99
3/4"	25	S	M36x2	84306362512	75,35
1"	25	S	M36x2	84306362516	86,73
3/4"	30	S	M42x2	84306423012	162,48
1"	30	S	M42x2	84306423016	109,76
1" 1/4	38	S	M52x2	84306523820	175,35

Ampliamos nuestra gama de **conexiones métricas**

We extend our range of **metric fittings**

Conexiones Standard

Standard series
Embouts série standard
Serie Standard

Espigas lisas rectas Métricas

Metric standpipe for DIN 2353 fittings

Embout lisse droit Métrique

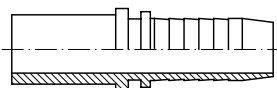

Estremità tubolare per raccordi DIN 2353

DN	PIPE TUBO	Part n° Referencia	€
3.2 mm	6	841580601	9,89
3/16"	6	841580603	9,42
1/4"	6	841580604	8,20
3/16"	8	841580803	8,98
1/4"	8	841580804	7,67
5/16"	8	841580805	10,50
3/8"	8	841580806	10,56
1/4"	10	841581004	8,88
5/16"	10	841581005	9,40
3/8"	10	841581006	8,27
1/4"	12	841581204	11,98
5/16"	12	841581205	11,89
3/8"	12	841581206	8,12
1/2"	12	841581208	11,60
3/8"	14	841581406	11,34
1/2"	14	841581408	14,80
3/8"	15	841581506	14,23
1/2"	15	841581508	11,29
1/2"	16	841581608	12,46
1/2"	18	841581808	17,49
5/8"	18	841581810	18,40
3/4"	18	841581812	23,57
1/2"	20	841582008	18,62
5/8"	20	841582010	20,50
3/4"	20	841582012	20,64
5/8"	22	841582210	20,95
3/4"	22	841582212	21,81
3/4"	25	841582512	27,09
1"	25	841582516	27,87
1"	28	841582816	26,27
1"	30	841583016	32,18
1 1/4"	35	841583520	41,47
1 1/4"	38	841583820	50,04
1 1/2"	38	841583824	56,06
1 1/2"	42	841584224	53,69

Espigas lisas rectas para tubo en pulgadas

Fractional Straight standpipe

Embout lisse tube pouce



Estremità tubolare serie pollici

DN	PIPE TUBO	Part n° Referencia	€
1/4"	6.4	841590604	11,15
3/8"	9.5	841590906	13,76
3/8"	12.7	841591206	13,84
1/2"	12.7	841591208	14,78
5/8"	15.8	841591510	19,15
3/4"	19.05	841591912	28,35

Espigas lisas 90° Métricas

Metric standpipe DIN 2353 fittings (90° Elbow)

Embout lisse coude 90° Métrique

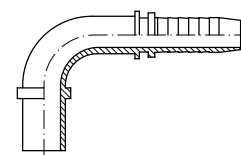

Estremità tubolare 90° per raccordi DIN 2353

DN	PIPE TUBO	Part n° Referencia	€
1/8"	6	842580602	30,16
3/16"	6	842580603	25,95
1/4"	6	842580604	19,25
3/16"	8	842580803	24,66
1/4"	8	842580804	18,66
5/16"	8	842580805	21,66
1/4"	10	842581004	19,17
5/16"	10	842581005	23,15
3/8"	10	842581006	23,94
1/4"	12	842581204	24,50
5/16"	12	842581205	25,26
3/8"	12	842581206	20,30
1/2"	12	842581208	29,30
3/8"	14	842581406	27,58
1/2"	14	842581408	36,72
3/8"	15	842581506	34,90
1/2"	15	842581508	30,24
1/2"	16	842581608	35,88
1/2"	18	842581808	35,98
5/8"	18	842581810	36,24
5/8"	20	842582010	42,39
3/4"	20	842582012	40,65
5/8"	22	842582210	62,57
3/4"	22	842582212	40,90
3/4"	25	842582512	44,46
1"	28	842582816	67,84
1"	30	842583016	68,17

Espigas lisas 90° para tubo en pulgadas

Fractional standpipe (90° Elbow)

Embout lisse coude 90° tube pouce

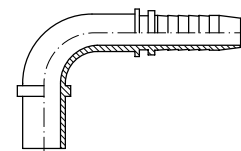

Estremità tubolare 90° serie pollici

DN	PIPE TUBO	Part n° Referencia	€
1/4"	6.4	842590604	30,24
3/8"	9.5	842590906	33,38
1/2"	12.7	842591208	34,69

Conexiones Standard

Standard series
Embouts série standard
Serie Standard

Espigas lisas 45° Métricas

Metric standpipe DIN 2353 fittings (45° Elbow)

Embout lisse coude 45° Métrique

Estremità tubolare 45° per raccordi DIN 2353

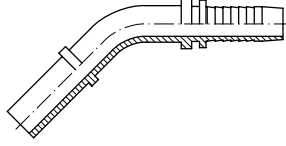

DN	PIPE TUBO	Part n° Referencia	€
1/8"	6	843580602	30,16
3/16"	6	843580603	25,95
1/4"	6	843580604	19,25
3/16"	8	843580803	24,66
1/4"	8	843580804	18,66
5/16"	8	843580805 *	21,66
1/4"	10	843581004	19,17
5/16"	10	843581005	23,15
3/8"	10	843581006	23,94
1/4"	12	843581204	24,50
5/16"	12	843581205	25,26
3/8"	12	843581206	20,30
1/2"	12	843581208	29,30
3/8"	14	843581406	27,58
1/2"	14	843581408	36,72
3/8"	15	843581506	34,90
1/2"	15	843581508	30,24
1/2"	16	843581608	35,88
1/2"	18	843581808	35,98
5/8"	18	843581810	36,24
5/8"	20	843582010	42,39
1/2"	20	843582012	40,65
5/8"	22	843582210	62,57
3/4"	22	843582212	40,90
3/4"	25	843582512	44,46
1"	28	843582816	67,84
1"	30	843583016	68,17

*Hasta fin de existencias / *Until end of stock / *Jusqu'à la fin du stock / *Fino ad esaurimento scorta

Espigas lisas 45° para tubo en pulgadas

Fractional Standpipe for inch tube (45° Elbow)

Embout lisse coude 45° tube pouce

Estremità tubolare 45° serie pollici

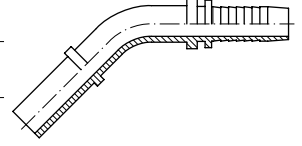

DN	PIPE TUBO	Part n° Referencia	€
1/4"	6.4	843590604	30,24
3/8"	9.5	843590906	33,38
1/2"	12.7	843591208	34,69

Espigas de prensar dobles

Double crimp standpipe

Embout double jonction

Giunzione tubo-tubo

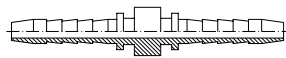

DN	Part n° Referencia	€
1/4"	843000404	21,97
5/16"	843000505	24,05
3/8"	843000606	24,15
1/2"	843000808	30,09
3/4"	843001212	49,94
1"	843001616	58,88
1"1/4	843002020	119,30
1"1/2	843002424	134,66
2"	843003232	285,24

Espigas soldables

Welding standpipes

Embout lisse à souder

Inseriti a saldare

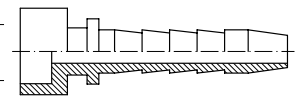

DN	Part n° Referencia	€
1/8"	840000200 *	13,47
3/16"	840000300	17,72
1/4"	840000400	10,33
5/16"	840000500	13,92
3/8"	840000600	18,52
1/2"	840000800	14,60
5/8"	840001000	22,08
3/4"	840001200	22,93
1"	840001600	24,36
1"1/4	840002000	51,87
1"1/2	840002400	61,44
2"	840003200	95,10
2"1/2	840004000	179,18

*Hasta fin de existencias / *Until end of stock. / *Jusqu'à la fin du stock / *Fino ad esaurimento scorta

Conexiones Standard

Standard series
Embouts série standard
Serie Standard

Orientables BSP

Banjo BSP

Banjo droit gaz BSP

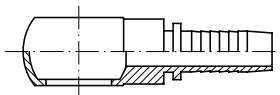

Raccordo ad occhio BSP

DN	Ø	Part n° Referencia	€
1/4"	1/4"	841110404	32,79
5/16"	3/8"	841110605	43,23
3/8"	3/8"	841110606	37,27
1/2"	3/8"	841110608	59,09
3/8"	1/2"	841110806	64,38
1/2"	1/2"	841110808	57,06
3/4"	3/4"	841111212	88,07
1"	1"	841111616	195,98

Tornillo orientable simple BSP

BSP Bolt for banjo

Vis creuse simple pour banjo gaz

Bullone forato BSP

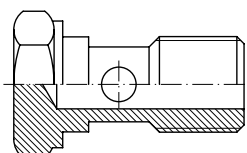

THREAD ROSCA	Part n° Referencia	€
1/4" BSP	Z109004	*
3/8" BSP	Z109006	*
1/2" BSP	Z109008	*
3/4" BSP	Z109012	*
1" BSP	Z109016	*

*Ver precios en p.155 (ADAPTADORES BSP) / *See prices in p.155 (BSP ADAPTORS) / *Prix à la p.155 (ADAPTEURS BSP) / *Vedere prezzi p.155 (ADATTATORI BSP)

Orientables Métricos

Banjo Metric

Banjo droit Métrique

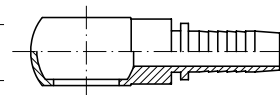

Raccordo ad occhio Metrico

DN	Ø	Part n° Referencia	€
1/4"	M12x1.5	841161204	41,40
1/4"	M14x1.5	841161404	37,80
5/16"	M16x1.5	841161605	51,08
3/8"	M16x1.5	841161606	46,32
3/8"	M18x1.5	841161806	55,39
1/2"	M18x1.5	841161808	65,62
1/2"	M20x1.5	841162008	68,61
1/2"	M22x1.5	841162208	68,61
3/4"	M26x1.5	841162612	86,18

Tornillo orientable simple Métrico

Metric bolt for banjo

Vis creuse simple for banjo Métrique

Bullone forato Metrico

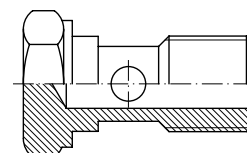

THREAD ROSCA	Part n° Referencia	€
M12X1.5	Z109212	*
M14X1.5	Z109214	*
M16X1.5	Z109216	*
M18X1.5	Z109218	*
M22X1.5	Z109222	*
M26X1.5	Z109226	*
M30X2	Z109230	*

*Ver precios en p.155 (ADAPTADORES BSP) / *See prices in p.155 (BSP ADAPTORS) / *Prix à la p.155 (ADAPTEURS BSP) / *Vedere prezzi p.155 (ADATTATORI BSP)

Espigas para Hidrolavadoras

Standpipes for hidrowashing machines

Embouts lisses pour hydronettoyages

Inserti per idropulitrici

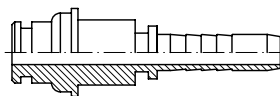

PIPE TUBO	THREAD ROSCA	Part n° Referencia	€
5/16"	M 22x1.5	8305005	19,54
3/8"	M 22x1.5	8305006	20,68

Tuercas para terminales hidrolavadoras inox

Hexagonal nuts for hidrowashing machines

Écrous pour hydronettoyages

Dado per idropulitrici

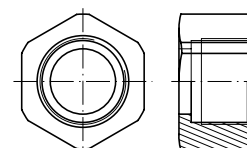

THREAD ROSCA	Part n° Referencia	€
M22x1.5	KZTHAP22	14,14

Conexiones Standard

Standard series

Embouts série standard

Serie Standard

Pipe fittings

Pipe fittings II

Adaptors

Welding fittings

Industrial fittings

Accessories

Control components

Flow measuring

Tralle LOK

Bridas rectas SAE 3000 PSI

3000 PSI SAE Straight Flange / Code 61

Bride SAE droite série 3000 PSI

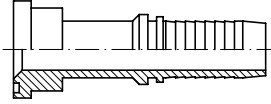

Flangia diritta SAE 3000

DN	Ø	Part n° Referencia	€
1/2"	30,2	841820808	40,06
1/2"	38,1	841821208	66,89
5/8"	38,1	841821210	57,66
3/4"	38,1	841821212	53,28
3/4"	44,5	841821612	68,83
1"	44,5	841821616	65,65
1"	50,8	841822016	93,40
1"1/4	50,8	841822020	89,05
1"1/4	60,3	841822420	141,81
1"1/2	60,3	841822424	119,85
1"1/2	71,4	841823224	228,35
2"	71,4	841823232	188,60

Bridas 90° SAE 3000 PSI

3000 PSI SAE Flange (90° Elbow) / Code 61

Bride SAE coude 90° série 3000 PSI

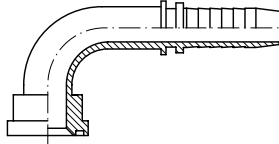

Flangia 90° SAE 3000

DN	Ø	Part n° Referencia	€
1/2"	30,2	841830808	59,50
1/2"	38,1	841831208	77,68
5/8"	38,1	841831210	90,91
3/4"	38,1	841831212	81,72
3/4"	44,5	841831612	119,50
1"	44,5	841831616	105,34
1"1/4	44,5	841831620	151,65
1"	50,8	841832016	170,04
1"1/4	50,8	841832020	157,10
1"1/4	60,3	841832420	249,95
1"1/2	60,3	841832424	223,62
1"1/2	71,4	841833224	376,15
2"	71,4	841833232	336,10

Bridas 45° SAE 3000 PSI

3000 PSI SAE Flange (45° Elbow) / Code 61

Bride SAE coude 45° série 3000 PSI

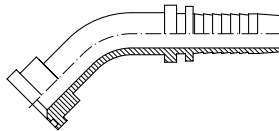

Flangia 45° SAE 3000

DN	Ø	Part n° Referencia	€
1/2"	30,2	841840808	59,50
1/2"	38,1	841841208	77,68
5/8"	38,1	841841210	90,91
3/4"	38,1	841841212	81,72
3/4"	44,5	841841612	119,50
1"	44,5	841841616	105,34
1"	50,8	841842016	170,04
1"1/4	50,8	841842020	157,10
1"1/4	60,3	841842420	249,95
1"1/2	60,3	841842424	223,62
1"1/2	71,4	841843224	376,15
2"	71,4	841843232	336,10

Bridas rectas SAE 6000 PSI

6000 PSI SAE Straight Flange / Code 62

Bride SAE droite série 6000 PSI

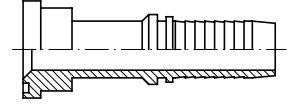

Flangia diritta SAE 6000

DN	Ø	Part n° Referencia	€
1/2"	31,8	842820808	47,11
1/2"	41,3	842821208	75,38
5/8"	41,3	842821210	80,97
3/4"	41,3	842821212	64,38
3/4"	47,6	842821612	79,67
1"	47,6	842821616	78,99
1"	54	842822016	123,16
1"1/4	54	842822020	113,17
1"1/4	63,5	842822420	155,89
1"1/2	63,5	842822424	141,80
1"1/2	79,4	842823224	274,72
2"	79,4	842823232	239,81

Bridas 90° SAE 6000 PSI

6000 PSI SAE Flange (90° Elbow) / Code 62

Bride SAE coude 90° série 6000 PSI

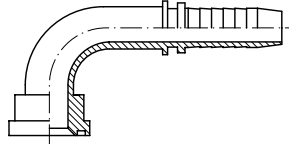

Flangia 90° SAE 6000

DN	Ø	Part n° Referencia	€
1/2"	31,8	842830808	59,71
1/2"	41,3	842831208	86,67
5/8"	41,3	842831210	102,32
3/4"	41,3	842831212	84,09
3/4"	47,6	842831612	121,36
1"	47,6	842831616	127,85
1"	54	842832016	174,46
1"1/4	54	842832020	159,73
1"1/4	63,5	842832420	268,49
1"1/2	63,5	842832424	263,39
1"1/2	79,4	842833224	389,56
2"	79,4	842833232	358,28

Bridas 45° SAE 6000 PSI

6000 PSI SAE Flange (45° Elbow) / Code 62

Bride SAE coude 45° série 6000 PSI

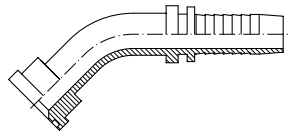

Flangia 45° SAE 6000

DN	Ø	Part n° Referencia	€
1/2"	31,8	842840808	59,71
1/2"	41,3	842841208	86,67
5/8"	41,3	842841210	102,32
3/4"	41,3	842841212	84,09
3/4"	47,6	842841612	121,36
1"	47,6	842841616	127,85
1"	54	842842016	174,46
1"1/4	54	842842020	159,73
1"1/4	63,5	842842420	268,49
1"1/2	63,5	842842424	262,17
1"1/2	79,4	842843224	389,56
2"	79,4	842843232	358,28

Conexiones Standard

Standard series
Embouts série standard
Serie Standard

Crimping fittings for hoses

Pipe fittings

Pipe fittings II

Adaptors

Welding fittings

Industrial fittings

Accessories

Control components

Flow measuring

Trile LOK

Brida partida pasante

SAE Split flange

Demi-bride de fixation

Semiflangua SAE

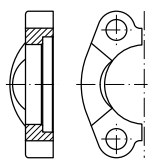

SERIE	Ø INNER Ø INT.	SIZE TAMAÑO	Part nº Referencia	€
3000 PSI	30.2	1/2"	ZBBP308302	13,33
3000 PSI	38.1	3/4"	ZBBP312381	17,20
3000 PSI	44.5	1"	ZBBP316445	20,48
3000 PSI	50.8	1 1/4"	ZBBP320508	29,56
3000 PSI	60.3	1 1/2"	ZBBP324603	38,83
3000 PSI	71.4	2"	ZBBP332714	46,90
3000 PSI	102.4	3"	ZBBP3481024	101,94
6000 PSI	31.8	1/2"	ZBBP608318	17,62
6000 PSI	41.3	3/4"	ZBBP612413	25,76
6000 PSI	47.6	1"	ZBBP616476	39,31
6000 PSI	54	1 1/4"	ZBBP620540	53,52
6000 PSI	63.5	1 1/2"	ZBBP624635	82,70
6000 PSI	79.4	2"	ZBBP632794	143,59

Brida entera pasante

SAE Flange

Bride de fixation monobloc

Flangia monoblocco SAE

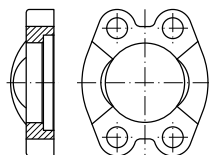

SERIE	Ø INNER Ø INT.	SIZE TAMAÑO	Part nº Referencia	€
3000 PSI	30.2	1/2"	ZBBE308302	13,86
3000 PSI	38.1	3/4"	ZBBE312381	17,89
3000 PSI	44.5	1"	ZBBE316445	20,48
3000 PSI	50.8	1 1/4"	ZBBE320508	30,74
3000 PSI	60.3	1 1/2"	ZBBE324603	40,38
3000 PSI	71.4	2"	ZBBE332714	47,82
6000 PSI	31.8	1/2"	ZBBE608318	16,94
6000 PSI	41.3	3/4"	ZBBE612413	25,76
6000 PSI	47.6	1"	ZBBE616476	37,80
6000 PSI	54	1 1/4"	ZBBE620540	55,66
6000 PSI	63.5	1 1/2"	ZBBE624635	84,32
6000 PSI	79.4	2"	ZBBE632794	143,59

Tornillos para bridas SAE

Screws for SAE flanges

Vis pour brides SAE

Vite per flangia SAE



THREAD ROSCA	SIZE TAMAÑO	Part nº Referencia	€
M8X35	3000-6000 PSI 1/2"	ZTB8X30	*
M10X35	3000 PSI 3/4"-1"	ZTB10X35	*
M10X40	3000 PSI 1" 1/4 - 6000 PSI 3/4"	ZTB10X40	*
M12X45	3000 PSI 1 1/2"-2"-2 1/2"-6000 PSI 1"	ZTB12X45	*
M14X45	6000 PSI 1 1/4"	ZTB14X45	*
M16X50	3000 PSI 3"-3 1/2"-4"- 6000 PSI 1" 1/2"	ZTB16X50	*
M20X70	6000 PSI 2"	ZTB20X70	*

*Ver precios en p.138 / *See prices p.138 / *Voir prix p.138 / *Vedere prezzi p.138

Contrabrida roscada

SAE counter-flange

Contre-bride passage total

Controflangua SAE

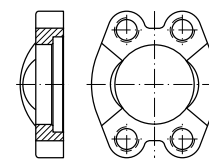

SERIE	Ø	SIZE TAMAÑO	Part nº Referencia	€
3000 PSI	30,2	1/2"	ZBCE308302	*
3000 PSI	38,1	3/4"	ZBCE312381	*
3000 PSI	44,5	1"	ZBCE316445	*
3000 PSI	50,8	1 1/4"	ZBCE320508	*
3000 PSI	60,3	1 1/2"	ZBCE324603	*
3000 PSI	71,4	2"	ZBCE332714	*
6000 PSI	31,8	1/2"	ZBCE608318	*
6000 PSI	41,3	3/4"	ZBCE612413	*
6000 PSI	47,6	1"	ZBCE616476	*
6000 PSI	54	1 1/4"	ZBCE620540	*
6000 PSI	63,5	1 1/2"	ZBCE624635	*
6000 PSI	79,4	2"	ZBCE632794	*

Juntas para bridas SAE 3000/6000 PSI

Seals for 3000/6000 PSI flange

Joints pour bride série 3000/6000

Guarnizioni per flangia SAE 3000/6000 PSI



Ø OUTER Ø EXT.	Ø INNER Ø INT.	SIZE TAMAÑO	Part nº Referencia	€
25.40	17.02	1/2"	JBR08	*
31.72	23.36	3/4"	JBR12	*
39.62	31.24	1"	JBR16	*
44.45	36.07	1 1/4"	JBR20	*
53.98	45.34	1 1/2"	JBR24	*
63.50	54.86	2"	JBR32	*

*Ver precios en Conducciones Hidráulicas y Neumáticas / *See prices in Hydraulic and Pneumatic Connectors' Catalogue / *Voir prix dans le Catalogue Connectique Hydraulique et Pneumatique / *Vedere prezzi nel listino Conduzioni Idrauliche e Pneumatiche

Juntas tóricas para bridas SAE 3000/6000 PSI

O' rings for 3000/6000 PSI flange

O' rings pour bride série 3000/6000 PSI

O' rings per flangia SAE 3000/6000 PSI



Ø INNER Ø INT.	SIZE TAMAÑO	Part nº Referencia	€
18.64	1/2"	18.64X3.53	*
24.99	3/4"	24.99X3.53	*
32.92	1"	32.92X3.53	*
37.70	1 1/4"	37.70X3.53	*
47.22	1 1/2"	47.22X3.53	*
56.74	2"	56.74X3.53	*

*Ver precios en Conducciones Hidráulicas y Neumáticas / *See prices in Hydraulic and Pneumatic Connectors' Catalogue / *Voir prix dans le Catalogue Connectique Hydraulique et Pneumatique / *Vedere prezzi nel listino Conduzioni Idrauliche e Pneumatiche

Conexiones Standard

Standard series
Embouts série standard
Serie Standard

Pipe fittings

Pipe fittings II

Adaptors

Welding fittings

Industrial fittings

Accessories

Control components

Flow measuring

Tralle LOK

Hembras giratorias rectas ORFS doble hexagonal

Double hexagonal ORFS Swivel female straight

Femelle droite ORFS double hexagonal

Femmina diritta ORFS doppio esagono

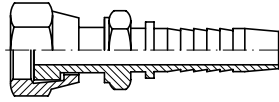

DN	THREAD ROSCA	Part n° Referencia	€
1/4"	9/16"-18h	849010904	29,43
1/4"	11/16"-16h	849011104	40,32
5/16"	11/16"-16h	849011105	37,67
3/8"	11/16"-16h	849011106	32,87
3/8"	13/16"-16h	849011306	42,16
1/2"	13/16"-16h	849011308	37,24
1/2"	1"-14h	849011608	73,64
5/8"	1"-14h	849011610	56,82
1/2"	1"3/16-12h	849011908	85,50
3/4"	1"3/16-12h	849011912	59,66
3/4"	1"7/16-12h	849012312	95,47
1"	1"7/16-12h	849012316	82,65
1"1/4	1" 11/16-12h	849012720	152,86
1"1/2	2"-12h	849013224	182,41

Machos ORFS

ORFS Male

Mâle ORFS

Maschio ORFS

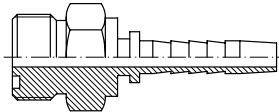

DN	THREAD ROSCA	Part n° Referencia	€
1/4"	9/16"-18h	849120904	35,61
5/16"	11/16"-16h	849121105	31,00
3/8"	11/16"-16h	849121106	33,69
1/2"	13/16"-16h	849121308	42,12
5/8"	1"-14h	849121610	62,10
3/4"	1"3/16-12h	849121912	77,51
1"	1"7/16-12h	849122316	106,32
1"1/4	1" 11/16-12h	849122720	147,05
1"1/2	2"-12h	849123224	218,59

Hembras giratorias 90° ORFS

ORFS Swivel female (90° Elbow)

Coude 90° femelle ORFS

Femmina 90° ORFS

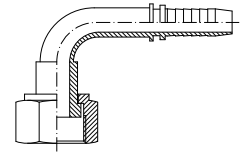

DN	THREAD ROSCA	Part n° Referencia	€
1/4"	9/16"-18h	849070904	55,48
1/4"	11/16"-16h	849071104	70,23
5/16"	11/16"-16h	849071105	68,64
3/8"	11/16"-16h	849071106	66,52
3/8"	13/16"-16h	849071306	73,55
1/2"	13/16"-16h	849071308	77,17
1/2"	1"-14h	849071608	110,67
5/8"	1"-14h	849071610	97,93
3/4"	1"3/16-12h	849071912	123,22
3/4"	1"7/16-12h	849072312	183,62
1"	1"7/16-12h	849072316	178,90
1"1/4	1" 11/16-12h	849072720	251,37
1"1/2	2"-12h	849073224	723,42

Hembras giratorias 45° ORFS

ORFS Swivel female (45° Elbow)

Coude 45° femelle ORFS

Femmina 45° ORFS

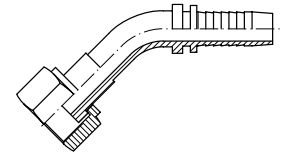

DN	THREAD ROSCA	Part n° Referencia	€
1/4"	9/16"-18h	849080904	55,48
1/4"	11/16"-16h	849081104	70,23
5/16"	11/16"-16h	849081105	68,64
3/8"	11/16"-16h	849081106	66,52
3/8"	13/16"-16h	849081306	73,55
1/2"	13/16"-16h	849081308	77,17
1/2"	1"-14h	849081608	110,67
5/8"	1"-14h	849081610	97,93
3/4"	1"3/16-12h	849081912	123,22
3/4"	1"7/16-12h	849082312	183,62
1"	1"7/16-12h	849082316	178,90
1"1/4	1" 11/16-12h	849082720	251,37
1"1/2	2"-12h	849083224	723,42

Conexiones Serie BW R12/4SP/4SH No Pelar

Fittings BW Series R12/4SP/4SH No Skive

Embouts R12/4SP/4SH Série BW Sans dénuder

Raccordi R12/4SP/4SH Serie BW senza spellatura

Casquillos R12/4SP/4SH para conexiones serie BW

Ferrules R12/4SP/4SH for fittings BW series

Jupes R12/4SP/4SH pour embouts série BW

Boccole pressare per R12/4SP/4SH per raccordi serie BW

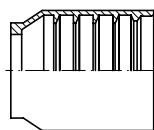

DN	Part n° Referencia	€
1/2"	ZAC680100800	25,11
5/8"	ZAC680101000	27,57
3/4"	ZAC680101200	35,19
1"	ZAC680101600	45,23
1"1/4	ZAC680102000	69,97
1"1/2	ZAC680102400	101,98
2"	ZAC680103200	152,68

Hembras giratorias 90° BSP cono 60° con junta

BSP Swivel female 60° cone with o'ring (90° Elbow)

Coude 90° femelle tournante gaz cyl BSP 60° avec joint

Femmina a 90° BSP sede 60° con o'ring

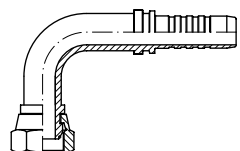

DN	THREAD ROSCA	Part n° Referencia	€
1/2"	1/2" BSP	Z661170808	49,92
5/8"	5/8" BSP	Z661171010	78,11
3/4"	3/4" BSP	Z661171212	58,95
1"	1" BSP	Z661171616	85,08
1"1/4	1"1/4 BSP	Z661172020	130,14
1"1/2	1"1/2 BSP	Z661172424	200,29
2"	2" BSP	Z661173232	358,01

Machos cilíndricos BSP 60°

BSP Male 60° cone

Mâle gaz cylindrique BSP 60°

Maschio BSP cilindrico sede 60°

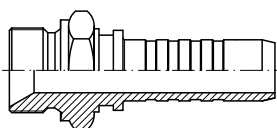

DN	THREAD ROSCA	Part n° Referencia	€
1/2"	1/2" BSP	Z661120808	27,45
5/8"	5/8" BSP	Z661121010	37,97
3/4"	3/4" BSP	Z661121212	41,09
1"	1" BSP	Z661121616	55,74
1"1/4	1"1/4 BSP	Z661122020	97,19
1"1/2	1"1/2 BSP	Z661122424	135,23
2"	2" BSP	Z661123232	266,54

Hembras giratorias rectas BSP cono 60° doble hexagonal con junta

BSP Swivel female 60° cone double hexagonal with o'ring

Femelle tournante gaz cyl BSP 60° double hexagonale avec o'ring

Femmina diritta BSP sede 60° doppia esagono con o'ring

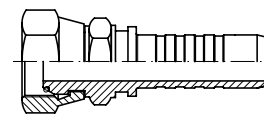

DN	THREAD ROSCA	Part n° Referencia	€
1/2"	1/2" BSP	Z664100808	38,16
5/8"	5/8" BSP	Z664101010	55,17
5/8"	3/4" BSP	Z664101212	56,67
1"	1" BSP	Z664101616	91,68
1"1/4	1"1/4 BSP	Z664102020	187,99
1"1/2	1"1/2 BSP	Z664102424	249,76
2"	2" BSP	Z664103232	509,57

Hembras giratorias 45° BSP cono 60° con junta

BSP Swivel female 60° cone with o'ring (45° Elbow)

Hembras giratorias 45° BSP cono 60° avec o'ring

Femmina a 45° BSP sede 60° con o'ring

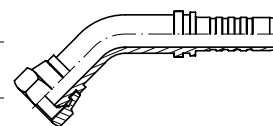

DN	THREAD ROSCA	Part n° Referencia	€
1/2"	1/2" BSP	Z661180808	49,92
5/8"	5/8" BSP	Z661181010	78,11
3/4"	3/4" BSP	Z661181212	58,95
1"	1" BSP	Z661181616	85,08
1"1/4	1"1/4 BSP	Z661182020	130,14
1"1/2	1"1/2 BSP	Z661182424	200,29
2"	2" BSP	Z661183232	358,01

Conexiones Serie BW R12/4SP/4SH No Pelar

Fittings BW Series R12/4SP/4SH No Skive

Embouts R12/4SP/4SH Série BW Sans dénuder

Raccordi R12/4SP/4SH Serie BW senza spellatura

Hembras giratorias rectas NPSM cono 60° doble hexagonal con junta

Double hexagonal NPSM female 60° cone with o'ring

Femelle NPSM cone 60° double hexagonal avec joint torique

Femmina diritta NPSM sede 60° doppio esagono con o'ring

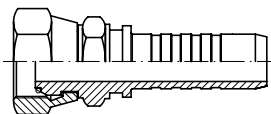

DN	THREAD ROSCA	Part n° Referencia	€
1/2"	1/2" NPSM	Z664610808	35,02
3/4"	3/4" NPSM	Z664611212	59,50
1"	1" NPSM	Z664611616	96,26
1"1/4	1"1/4 NPSM	Z664612020	197,39
1"1/2	1"1/2 NPSM	Z664612424	262,25
2"	2" NPSM	Z664613232	383,33

Machos cónicos NPT

NPT Male pipe straight

Mâle conique NPT

Maschio conico NPT

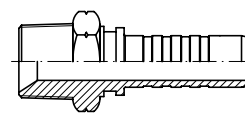

DN	THREAD ROSCA	Part n° Referencia	€
1/2"	1/2" NPT	Z661610808	28,16
3/4"	3/4" NPT	Z661611212	37,59
1"	1" NPT	Z661611616	53,05
1"1/4	1"1/4 NPT	Z661612020	94,17
1"1/2	1"1/2 NPT	Z661612424	135,79
2"	2" NPT	Z661613232	271,82

Hembras giratorias rectas JIC 37° doble hexagonal

Double Hexagonal JIC 37° Swivel female

Femelle JIC 37° double hexagonal

Femmina diritta JIC 37° doppio esagono

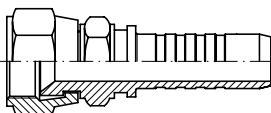

DN	THREAD ROSCA	Part n° Referencia	€
1/2"	3/4" 16h UNF	Z662421208	30,27
5/8"	7/8" 14h UNF	Z662421410	43,90
3/4"	1"1/16 12h UNF	Z662421712	56,64
1"	1"1/16 12h UNF	Z662421716	69,18
1"	1"5/16 12h UNF	Z662422116	86,64
1"1/4	1"5/8 12h UNF	Z662422620	208,00
1"1/2	1"7/8 12h UNF	Z662423024	312,53
2"	2"1/2 12h UNF	Z662424032	464,91

Hembras giratorias 45° JIC 37°

JIC 37° Swivel female (45° Elbow)

Coude 45° femelle JIC 37°

Femmina gir. 45° JIC 37°

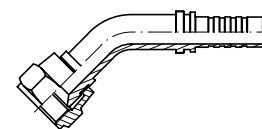

DN	THREAD ROSCA	Part n° Referencia	€
1/2"	3/4" 16h UNF	Z661391208	37,21
5/8"	7/8" 14h UNF	Z661391410	48,14
3/4"	1"1/16 12h UNF	Z661391712	59,52
1"	1"5/16 12h UNF	Z661392116	85,30
1"1/4	1"5/8 12h UNF	Z661392620	131,78
1"1/2	1"7/8 12h UNF	Z661393024	188,90
2"	2"1/2 12h UNF	Z661394032	385,29

Hembras giratorias 90° JIC 37°

JIC 37° Swivel female (90° Elbow)

Coude 90° femelle JIC 37°

Femmina gir. 90° JIC 37°

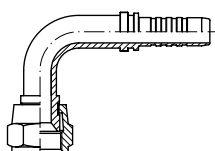

DN	THREAD ROSCA	Part n° Referencia	€
1/2"	3/4" 16h UNF	Z661381208	37,21
5/8"	7/8" 14h UNF	Z661381410	48,14
3/4"	1"1/16 12h UNF	Z661381712	59,52
1"	1"1/16 12h UNF	Z661381716	102,24
1"	1"5/16 12h UNF	Z661382116	85,30
1"1/4	1"5/8 12h UNF	Z661382620	131,78
1"1/2	1"7/8 12h UNF	Z661383024	188,90
2"	2"1/2 12h UNF	Z661384032	385,29

Machos JIC 37° con junta

JIC 37° male with o'ring

Mâle JIC 37° avec joint torique

Maschio JIC 37° con o'ring

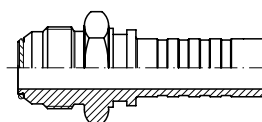

DN	THREAD ROSCA	Part n° Referencia	€
1/2"	3/4" 16h UNF	Z661411208	32,07
5/8"	7/8" 14h UNF	Z661411410	37,99
3/4"	1"1/16 12h UNF	Z661411712	49,73
1"	1"5/16 12h UNF	Z661412116	67,47
1"1/4	1"5/8 12h UNF	Z661412620	93,67
1"1/2	1"7/8 12h UNF	Z661413024	104,99
2"	2"1/2 12h UNF	Z661414032	228,69

Conexiones Serie BW R12/4SP/4SH No Pelar

Fittings BW Series R12/4SP/4SH No Skive

Embouts R12/4SP/4SH Série BW Sans dénuder

Raccordi R12/4SP/4SH Serie BW senza spellatura

Hembras giratorias rectas ORFS doble hexagonal

ORFS Swivel female straight

Femelle droite ORFS

Femmina diritta ORFS

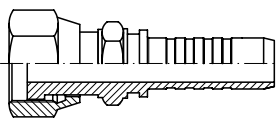

DN	THREAD ROSCA	Part nº Referencia	€
1/2"	1"3/16-1/2"	Z669011308	50,96
5/8"	1"-5/8"	Z669011610	73,87
3/4"	1"3/16-3/4"	Z669011912	77,56
1"	1"7/16-1"	Z669012316	113,88
1"1/4	1"11/16-1"1/4	Z669012720	149,11
1"1/2	2"-1"1/2	Z669013224	213,47

Hembras giratorias 90° ORFS asiento plano

ORFS Swivel female (90° Elbow)

Coude 90° femelle ORFS

Femmina 90° ORFS

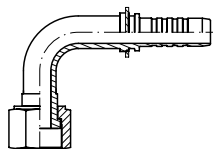

DN	THREAD ROSCA	Part nº Referencia	€
1/2"	1"3/16-1/2"	Z669071308	96,46
5/8"	1"-5/8"	Z669071610	132,61
3/4"	1"3/16-3/4"	Z669071912	218,52
1"	1"7/16-1"	Z669072316	318,94
1"1/4	1"11/16-1"1/4	Z669072720	447,20
1"1/2	2"-1"1/2	Z669073224	1.301,81

Hembras giratorias Métricas cono 24° con junta tórica

Metric swivel female 24° seat with o'ring

Femelle Métrique 24° avec o'ring

Femmina Metrica sede 24° con o'ring

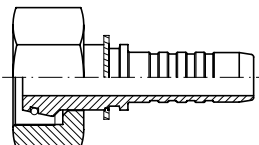

DN	PIPE TUBO	SERIE	THREAD ROSCA	Part nº Referencia	€
1/2"	16	S	M24x1.5	Z66204241608	27,53
5/8"	20	S	M30x2	Z66204302010	82,02
3/4"	20	S	M30x2	Z66204302012	46,56
3/4"	25	S	M36x2	Z66204362512	61,42
1"	25	S	M36x2	Z66204362516	83,09
1"	30	S	M42x2	Z66204423016	74,04
1"1/4	38	S	M52x2	Z66204523820	95,19

Hembras giratorias 90° Métricas cono 24° con junta tórica

Metric swivel female 24° seat with o'ring (90° Elbow)

Coude 90° femelle Métrique 24° avec o'ring

Femmina Metrica 90° sede 24° con o'ring

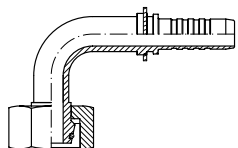

DN	PIPE TUBO	SERIE	THREAD ROSCA	Part nº Referencia	€
1/2"	16	S	M24x1.5	Z66205241608	39,18
3/4"	20	S	M30x2	Z66205302012	64,12
3/4"	25	S	M36x2	Z66205362512	97,96
1"	25	S	M36x2	Z66205362516	136,15
1"	30	S	M42x2	Z66205423016	123,63
1"1/4	38	S	M52x2	Z66205523820	162,57

Hembras giratorias 45° ORFS asiento plano

ORFS Swivel female (45° Elbow)

Coude 45° femelle ORFS

Femmina 45° ORFS

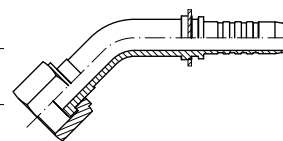

DN	THREAD ROSCA	Part nº Referencia	€
1/2"	1"3/16-1/2"	Z669081308	96,46
5/8"	1"-5/8"	Z669081610	132,61
3/4"	1"3/16-3/4"	Z669081912	218,52
1"	1"7/16-1"	Z669082316	318,94
1"1/4	1"11/16-1"1/4	Z669082720	447,20
1"1/2	2"-1"1/2	Z669083224	1.301,81

Machos ORFS

ORFS Male

Mâle ORFS

Maschio ORFS

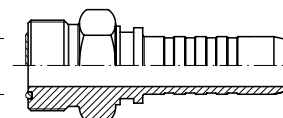

DN	THREAD ROSCA	Part nº Referencia	€
1/2"	1"3/16-1/2"	Z669121308	49,39
5/8"	1"-5/8"	Z669121610	80,73
3/4"	1"3/16-3/4"	Z669121912	128,12
1"	1"7/16-1"	Z669122316	190,40
1"1/4	1"11/16-1"1/4	Z669122720	267,40
1"1/2	2"-1"1/2	Z669123224	393,54

Hembras giratorias 45° Métricas cono 24° con junta tórica

Metric swivel female 24° seat with o'ring (45° Elbow)

Coude 45° femelle Métrique 24° avec o'ring

Femmina Metrica 45° sede 24°

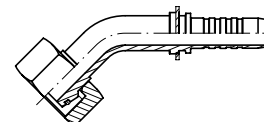

DN	PIPE TUBO	SERIE	THREAD ROSCA	Part nº Referencia	€
1/2"	16	S	M24x1.5	Z66206241608	39,18
3/4"	20	S	M30x2	Z66206302012	64,12
3/4"	25	S	M36x2	Z66206362512	97,96
1"	30	S	M42x2	Z66206423016	123,63
1"1/4	38	S	M52x2	Z66206523820	162,57

Machos fijos Métricos cono 24°

Metric male stud 24° cone

Mâle Métrique cone 24°

Maschio Metrico sede 24° con o'ring



DN	PIPE TUBO	SERIE	THREAD ROSCA	Part nº Referencia	€
1/2"	16	S	M24x1.5	Z66203241608	28,07
3/4"	20	S	M30x2	Z66203302012	49,27
3/4"	25	S	M36x2	Z66203362512	68,84
1"	30	S	M42x2	Z66203423016	78,83
1"1/4	38	S	M52x2	Z66203523820	135,30

Conexiones Serie BW R12/4SP/4SH No Pelar

Fittings BW Series R12/4SP/4SH No Skive

Embouts R12/4SP/4SH Série BW Sans dénuder

Raccordi R12/4SP/4SH Serie BW senza spellatura

Bridas rectas SAE 3000 PSI

3000 PSI SAE Straight Flange / Code 61

Bride SAE droite série 3000 PSI

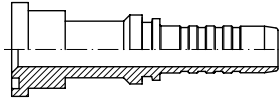

Flangia diritta SAE 3000

DN	Ø	Part n° Referencia	€
1/2"	30.2	Z661820808	57,28
5/8"	38.1	Z661821210	74,96
3/4"	38.1	Z661821212	60,75
1"	44.5	Z661821616	75,46
1"1/4	50.8	Z661822020	125,74
1"1/2	60.3	Z661822424	160,60
2"	71.4	Z661823232	250,43

Bridas recta SAE 6000 PSI

6000 PSI SAE Straight Flange / Code 62

Bride SAE droite série 6000 PSI

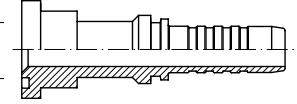

Flangia diritta SAE 6000

DN	Ø	Part n° Referencia	€
1/2"	31.8	Z662820808	61,24
5/8"	41.3	Z662821210	95,15
3/4"	41.3	Z662821212	69,38
1"	47.6	Z662821616	83,34
1"1/4	54	Z662822020	127,63
1"1/2	63.5	Z662822424	162,73
2"	79.4	Z662823232	262,83

Bridas a 90° SAE 3000 PSI

3000 PSI SAE Flange (90° Elbow) / Code 61

Bride SAE coude 90° série 3000 PSI

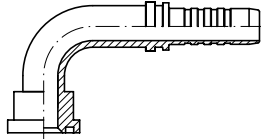

Flangia 90° SAE 3000

DN	Ø	Part n° Referencia	€
1/2"	30.2	Z661830808	77,35
5/8"	38.1	Z661831210	110,95
3/4"	38.1	Z661831212	87,59
1"	44.5	Z661831616	130,03
1"1/4	50.8	Z661832020	165,77
1"1/2	60.3	Z661832424	280,05
2"	71.4	Z661833232	393,04

Bridas a 90° SAE 6000 PSI

6000 PSI SAE Flange (90° Elbow) / Code 62

Bride SAE coude 90° série 6000 PSI

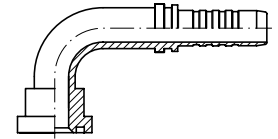

Flangia 90° SAE 6000

DN	Ø	Part n° Referencia	€
1/2"	31.8	Z662830808	77,62
5/8"	41.3	Z662831210	118,94
3/4"	41.3	Z662831212	93,87
1"	47.6	Z662831616	131,53
1"1/4	54	Z662832020	172,17
1"1/2	63.5	Z662832424	285,65
2"	79.4	Z662833232	406,52

Bridas a 45° SAE 3000 PSI

3000 PSI SAE Flange (45° Elbow) / Code 61

Bride SAE coude 45° série 3000 PSI

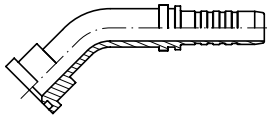

Flangia 45° SAE 3000

DN	Ø	Part n° Referencia	€
1/2"	30.2	Z661840808	77,35
5/8"	38.1	Z661841210	110,95
3/4"	38.1	Z661841212	87,59
1"	44.5	Z661841616	130,03
1"1/4	50.8	Z661842020	165,77
1"1/2	60.3	Z661842424	280,05
2"	71.4	Z661843232	393,04

Bridas a 45° SAE 6000 PSI

6000 PSI SAE Flange (45° Elbow) / Code 62

Bride SAE coude 45° série 6000 PSI

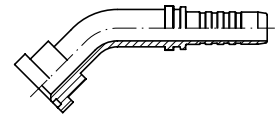

Flangia 45° SAE 6000

DN	Ø	Part n° Referencia	€
1/2"	31.8	Z662840808	77,62
5/8"	41.3	Z662841210	118,94
3/4"	41.3	Z662841212	93,87
1"	47.6	Z662841616	131,53
1"1/4	54	Z662842020	172,17
1"1/2	63.5	Z662842424	285,65
2"	79.4	Z662843232	406,52

Conexiones Interlock

Interlock series
Embouts Interlock
Serie Interlock

Casquillos Interlock 4SH

Ferrules DIN 20023 - 4SH Interlock

Jupes à sertir DIN 20023 - 4SH Interlock

Boccola pressare per DIN 20023 - 4SH Interlock

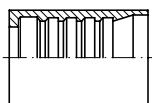

DN	DESCRIPTION DESCRIPCIÓN	Part n° Referencia	€
3/4"	4SH / R13 / R15	ZA610101200	30,00
1"	4SH / R13 / R15	ZA610101600	44,15
1"1/4	4SH	ZA610102000	68,32
1"1/2	4SH	ZA610102400	86,16
2"	4SH	ZA610103200	137,53

Casquillos Interlock R13/R15

Ferrules SAE 100 R13/R15 Interlock

Jupes à sertir R13/R15 Interlock

Boccola pressare per SAE 100 R13/R15 Interlock

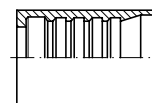

DN	Part n° Referencia	€
1" 1/4	Z610102000	75,75
1"1/2	Z610102400	94,70
2"	Z610103200	139,29

Para 3/4" y 1" son los mismos casquillos que en 4SH / 3/4" and 1" are the same ferrules as in 4SH / 3/4" et 1" sont les mêmes jupes que pour 4SH / Per 3/4" e 1" si utilizza la boccola 4SH

Hembras giratorias rectas rosca BSP cono 60° Interlock con junta

BSP 60° cone Swivel female Interlock with o'ring

Femelle droite gaz cylindrique BSP 60° Interlock avec joint torique

Femmina diritta BSP sede 60° Interlock con o'ring

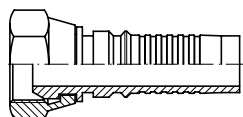

DN	THREAD ROSCA	Part n° Referencia	€
3/4"	3/4" BSP	Z641001212	37,66
1"	1" BSP	Z641001616	52,61
1"1/4	1"1/4 BSP	Z641002020	78,16
1"1/2	1"1/2 BSP	Z641002424	94,12
2"	2" BSP	Z641003232	162,41

Hembras giratorias BSP cono 60° doble hexagonal Interlock con junta

Double hexagonal BSP Swivel female cone 60° with o'ring

Femelle BSP cone 60° double hexagonal avec joint torique

Femmina diritta BSP sede 60° doppio esagono con o'ring

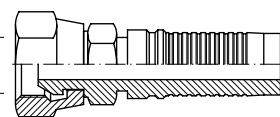

DN	THREAD ROSCA	Part n° Referencia	€
3/4"	3/4" BSP	Z644001212	54,82
1"	1" BSP	Z644001616	87,22
1"1/4	1"1/4 BSP	Z644002020	182,80
1"1/2	1"1/2 BSP	Z644002424	239,19
2"	2" BSP	Z644003232	495,50

Hembras giratoria 90° BSP cono 60° Interlock con junta

BSP 60° cone Swivel female Interlock (90° Elbow) with o'ring

Coude 90° femelle gaz cylindrique BSP 60° Interlock avec joint torique

Femmina 90° BSP sede 60° Interlock con o'ring

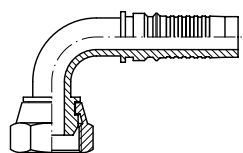

DN	THREAD ROSCA	Part n° Referencia	€
3/4"	3/4" BSP	Z641071212	57,61
1"	1" BSP	Z641071616	87,84
1"1/4	1"1/4 BSP	Z641072020	123,40
1"1/2	1"1/2 BSP	Z641072424	195,12
2"	2" BSP	Z641073232	363,49

Hembras giratoria 45° BSP cono 60° Interlock con junta

BSP 60° cone Swivel female Interlock (45° Elbow) with o'ring

Coude 45° femelle gaz cylindrique BSP 60° Interlock avec joint torique

Femmina 45° BSP sede 60° Interlock con o'ring

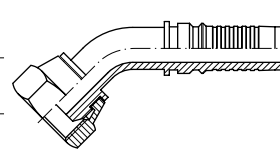

DN	THREAD ROSCA	Part n° Referencia	€
3/4"	3/4" BSP	Z641081212	57,61
1"	1" BSP	Z641081616	87,84
1"1/4	1"1/4 BSP	Z641082020	123,40
1"1/2	1"1/2 BSP	Z641082424	195,12
2"	2" BSP	Z641083232	363,49

Machos cilíndricos BSP cono 60° Interlock con junta

BSP 60° Male cone with Interlock o'ring

Mâle gaz cylindrique BSP 60° Interlock avec joint torique

Maschio BSP cilindrico sede 60° Interlock con o'ring

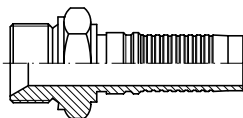

DN	THREAD ROSCA	Part n° Referencia	€
3/4"	3/4" BSP	Z641121212	42,08
1"	1" BSP	Z641121616	62,46
1"1/4	1"1/4 BSP	Z641122020	96,80
1"1/2	1"1/2 BSP	Z641122424	136,76
2"	2" BSP	Z641123232	259,18

Machos cónicos NPT Interlock

NPT Male pipe straight Interlock

Mâle conique NPT Interlock

Maschio conico NPT Interlock

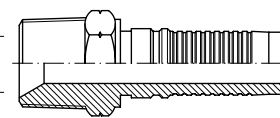

DN	THREAD ROSCA	Part n° Referencia	€
3/4"	3/4" NPT	Z641611212	36,55
1"	1" NPT	Z641611616	56,61
1"1/4	1"1/4 NPT	Z641612020	102,39
1"1/2	1"1/2 NPT	Z641612424	131,35
2"	2" NPT	Z641613232	262,93

Conexiones Interlock

Interlock series
Embouts Interlock
Serie Interlock

Pipe fittings

Pipe fittings II

Adaptors

Welding fittings

Industrial fittings

Accessories

Control components

Flow measuring

Tralle LOK

Hembras giratorias JIC 37° doble hexagonal Interlock

Double hexagonal JIC 37° Swivel female

Femelle JIC 37° double hexagonal

Femmina diritta JIC 37° doppio esagono

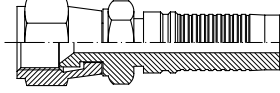

DN	THREAD ROSCA	Part n° Referencia	€
3/4"	1"1/16 12h UN	Z642421712	54,24
1"	1"5/16 12h UN	Z642422116	83,81
1"1/4	1"5/8 12h UN	Z642422620	197,89
1"1/2	1"7/8 12h UN	Z642423024	302,31
2"	2"1/2 12h UN	Z642424032	445,23

Hembras giratorias rectas JIC 37° Interlock

JIC 37° Swivel female Interlock

Femelle tourn.droite JIC 37° Interlock

Femmina gir.diritta JIC 37° Interlock

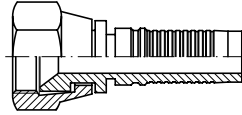

DN	THREAD ROSCA	Part n° Referencia	€
3/4"	1"1/16 12h UN	Z641421712	39,69
1"	1"5/16 12h UN	Z641422116	43,43
1"1/4	1"5/8 12h UN	Z641422620	73,77
1"1/4	1"7/8 12h UN	Z641423020	100,12
1"1/2	1"7/8 12h UN	Z641423024	103,39
2"	2"1/2 12h UN	Z641424032	188,89

Machos JIC 37° Interlock

JIC 37° male Interlock

Mâle JIC 37° Interlock

Maschio JIC 37° Interlock

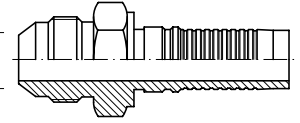

DN	THREAD ROSCA	Part n° Referencia	€
3/4"	1"1/16 12h UN	Z641401712	56,73
1"	1"5/16 12h UN	Z641402116	85,17
1"1/4	1"5/8 12h UN	Z641402620	94,72
1"1/2	1"7/8 12h UN	Z641403024	106,01
2"	2"1/2 12h UN	Z641404032	219,01

Hembras giratorias 90° JIC 37° Interlock

JIC 37° Swivel female Interlock (90° Elbow)

Coûde 90° femelle tournante JIC 37° Interlock

Femmina gir. 90° JIC 37° Interlock

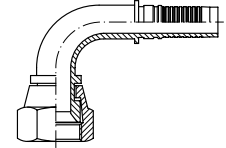

DN	THREAD ROSCA	Part n° Referencia	€
3/4"	1"1/16 12h UN	Z641381712	56,17
1"	1"5/16 12h UN	Z641382116	92,98
1"1/4	1"5/8 12h UN	Z641382620	127,47
1"1/2	1"7/8 12h UN	Z641383024	195,77
2"	2"1/2 12h UN	Z641384032	395,68

Hembras giratorias 45° JIC 37° Interlock

JIC 37° Swivel female Interlock (45° Elbow)

Coûde 45° femelle tournante JIC 37° Interlock

Femmina gir. 45° JIC 37° Interlock

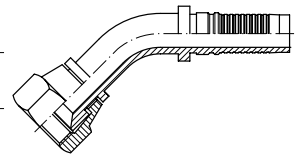

DN	THREAD ROSCA	Part n° Referencia	€
3/4"	1"1/16 12h UN	Z641391712	56,17
1"	1"5/16 12h UN	Z641392116	92,98
1"1/4	1"5/8 12h UN	Z641392620	127,47
1"1/2	1"7/8 12h UN	Z641393024	195,77
2"	2"1/2 12h UN	Z641394032	395,68

Conexiones Interlock

Interlock series
Embouts Interlock
Serie Interlock

Hembras giratorias rectas Métricas cono 24° Interlock con junta tórica

Metric swivel female 24° seat serie S Interlock with o'ring

Femelle droite Métrique 24° Interlock avec o'ring

Femmina Metrica sede 24° con o'ring serie S Interlock

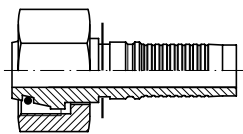

DN	PIPE TUBO	SERIE	THREAD ROSCA	Part nº Referencia	€
3/4"	20	S	M30x2	Z64204302012	45,04
3/4"	25	S	M36x2	Z64204362512	58,43
1"	30	S	M42x2	Z64204423016	70,63
1"1/4	38	S	M52x2	Z64204523820	101,14

Hembras 90° Métricas cono 24° Interlock con junta tórica

Metric swivel female 24° seat serie S Interlock with o'ring (90° Elbow)

Coude 90° femelle Métrique 24° Interlock avec o'ring

Femmina Metrica 90° sede 24° con o'ring serie S Interlock

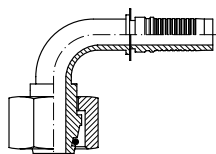

DN	PIPE TUBO	SERIE	THREAD ROSCA	Part nº Referencia	€
3/4"	20	S	M30x2	Z64205302012	67,22
3/4"	25	S	M36x2	Z64205362512	94,76
1"	30	S	M42x2	Z64205423016	124,37
1"1/4	38	S	M52x2	Z64205523820	165,78

Hembras giratorias rectas ORFS Interlock

Interlock ORFS Swivel female straight

Femelle droite ORFS Interlock

Femmina diritta ORFS Interlock

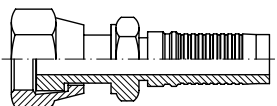

DN	THREAD ROSCA	Part nº Referencia	€
3/4"	1"3/16-12h	Z649011912	71,35
1"	1"7/16-12h	Z649012316	108,34
1"1/4	1" 11/16-12h	Z649012720	144,99
1"1/2	2"-12h	Z649013224	203,09

Machos ORFS Interlock

Interlock ORFS Male

Mâle ORFS Interlock

Maschio ORFS Interlock

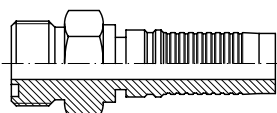

DN	THREAD ROSCA	Part nº Referencia	€
3/4"	1"3/16-12h	Z649121912	124,58
1"	1"7/16-12h	Z649122316	185,14
1"1/4	1" 11/16-12h	Z649122720	256,08
1"1/2	2"-12h	Z649123224	380,67

Hembras 45° Métricas cono 24° Interlock con junta tórica

Metric swivel female 24° seat serie S Interlock with o'ring (45° Elbow)

Coude 45° femelle Métrique 24° Interlock avec o'ring

Femmina Metrica 45° sede 24° serie S Interlock

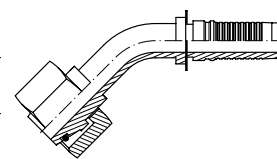

DN	PIPE TUBO	SERIE	THREAD ROSCA	Part nº Referencia	€
3/4"	20	S	M30x2	Z64206302012	64,63
3/4"	25	S	M36x2	Z64206362512	94,76
1"	30	S	M42x2	Z64206423016	124,37
1"1/4	38	S	M52x2	Z64206523820	165,78

Machos Métricos cono 24° Interlock

Metric male stud 24° cone serie S Interlock

Mâle Métrique cone 24° Interlock

Maschio Metrico sede 24° con o'ring serie S Interlock

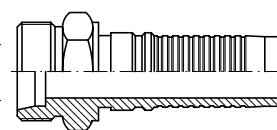

DN	PIPE TUBO	SERIE	THREAD ROSCA	Part nº Referencia	€
3/4"	20	S	M30x2	Z64203302012	47,91
3/4"	25	S	M36x2	Z64203362512	65,93
1"	30	S	M42x2	Z64203423016	88,80
1"1/4	38	S	M52x2	Z64203523820	131,56

Hembras giratorias 90° ORFS Interlock

Interlock ORFS Swivel female (90° Elbow)

Coude 90° femelle ORFS Interlock

Femmina 90° ORFS Interlock

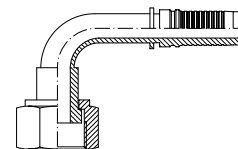

DN	THREAD ROSCA	Part nº Referencia	€
3/4"	1"3/16-12h	Z649071912	212,49
1"	1"7/16-12h	Z649072316	308,51
1"1/4	1" 11/16-12h	Z649072720	432,58
1"1/2	2"-12h	Z649073224	1.247,55

Hembras giratorias 45° ORFS Interlock

Interlock ORFS Swivel female (45° Elbow)

Coude 45° femelle ORFS Interlock

Femmina 45° ORFS Interlock

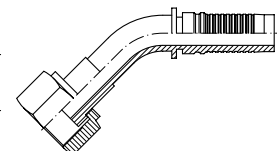

DN	THREAD ROSCA	Part nº Referencia	€
3/4"	1"3/16-12h	Z649081912	212,49
1"	1"7/16-12h	Z649082316	308,51
1"1/4	1" 11/16-12h	Z649082720	432,58
1"1/2	2"-12h	Z649083224	1.247,55

Conexiones Interlock

Interlock series

Embouts Interlock

Serie Interlock

Bridas rectas SAE 3000 PSI Interlock

3000 PSI SAE Straight Flange Interlock / Code 61

Bride SAE droite série 3000 PSI Interlock

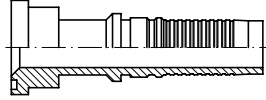

Flangia diritta SAE 3000 Interlock

DN	Ø	Part n° Referencia	€
3/4"	38.1	Z641821212	60,11
3/4"	44.5	Z641821612	68,49
1"	44.5	Z641821616	75,91
1"	50.8	Z641822016	94,70
1"1/4	50.8	Z641822020	119,63
1"1/4	60.3	Z641822420	143,96
1"1/2	60.3	Z641822424	155,91
1"1/2	71.4	Z641823224	239,77
2"	71.4	Z641823232	243,51

Bridas Rectas SAE 6000 PSI Interlock

6000 PSI SAE Straight Flange Interlock / Code 62

Bride SAE droite série 6000 PSI Interlock

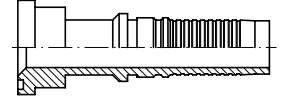

Flangia diritta SAE 6000 Interlock

DN	Ø	Part n° Referencia	€
3/4"	41.3	Z642821212	66,44
3/4"	47.6	Z642821612	79,23
1"	47.6	Z642821616	77,67
1"	54	Z642822016	122,48
1"1/4	54	Z642822020	121,42
1"1/4	63.5	Z642822420	161,78
1"1/2	63.5	Z642822424	161,40
1"1/2	79.4	Z642823224	281,43
2"	79.4	Z642823232	265,79

Bridas 90° SAE 3000 PSI Interlock

3000 PSI SAE Flange Interlock (90° Elbow) / Code 61

Coude 90° bride SAE série 3000 PSI Interlock

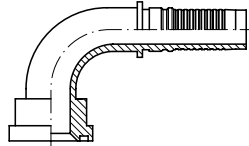

Flangia 90° SAE 3000 Interlock

DN	Ø	Part n° Referencia	€
3/4"	38.1	Z641831212	83,88
3/4"	44.5	Z641831612	123,85
1"	44.5	Z641831616	120,75
1"	50.8	Z641832016	190,27
1"1/4	50.8	Z641832020	153,94
1"1/4	60.3	Z641832420	263,65
1"1/2	60.3	Z641832424	272,32
1"1/2	71.4	Z641833224	389,99
2"	71.4	Z641833232	382,19

Bridas 90° SAE 6000 PSI Interlock

6000 PSI SAE Flange Interlock (90° Elbow) / Code 62

Coude 90° bride SAE série 6000 PSI Interlock

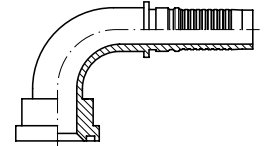

Flangia 90° SAE 6000 Interlock

DN	Ø	Part n° Referencia	€
3/4"	41.3	Z642831212	95,25
3/4"	47.6	Z642831612	130,72
1"	47.6	Z642831616	127,23
1"	54	Z642832016	193,12
1"1/4	54	Z642832020	163,80
1"1/4	63.5	Z642832420	272,54
1"1/2	63.5	Z642832424	268,28
1"1/2	79.4	Z642833224	419,99
2"	79.4	Z642833232	397,10

Bridas 45° SAE 3000 PSI Interlock

3000 PSI SAE Flange Interlock (45° Elbow) / Code 61

Coude 45° bride SAE série 3000 PSI Interlock

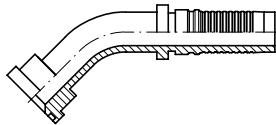

Flangia 45° SAE 3000 Interlock

DN	Ø	Part n° Referencia	€
3/4"	38.1	Z641841212	83,88
3/4"	44.5	Z641841612	123,85
1"	44.5	Z641841616	120,75
1"	50.8	Z641842016	190,27
1"1/4	50.8	Z641842020	153,94
1"1/4	60.3	Z641842420	263,65
1"1/2	60.3	Z641842424	272,32
2"	71.4	Z641843224	389,99
2"	71.4	Z641843232	382,19

Bridas 45° SAE 6000 PSI Interlock

6000 PSI SAE Flange Interlock (45° Elbow) / Code 62

Coude 45° bride SAE série 6000 PSI Interlock

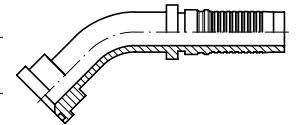

Flangia 45° SAE 6000 Interlock

DN	Ø	Part n° Referencia	€
3/4"	41.3	Z642841212	95,25
3/4"	47.6	Z642841612	130,72
1"	47.6	Z642841616	127,23
1"	54	Z642842016	193,12
1"1/4	54	Z642842020	163,80
1"1/4	63.5	Z642842420	272,54
1"1/2	63.5	Z642842424	268,28
1"1/2	79.4	Z642843224	419,99
2"	79.4	Z642843232	397,10

Pipe fittings

Pipe fittings II

Adaptors

Welding fittings

Industrial fittings

Accessories

Control components

Flow measuring

Tralle LOK

Conexiones una sola pieza Serie 43 R1AT/R2AT/1SN/2SN/R16/2SC/R17

One piece fittings 43 Series R1AT/R2AT/1SN/2SN/R16/2SC/R17

Embouts pré-sertis R1AT/R2AT/1SN/2SN/R16/2SC/R17 Série 43

Raccordi compatti R1AT/R2AT/1SN/2SN/R16/2SC/R17 Serie 43

Crimping fittings for hoses

Pipe fittings

Pipe fittings II

Adaptors

Welding fittings

Industrial fittings

Accessories

Control components

Flow measuring

Tri/Le LOK

Hembras giratorias rectas una sola pieza JIC 37°

One piece JIC 37° Swivel female

Femelle pré-sertie JIC 37°

Femmina diritta compatta JIC 37°

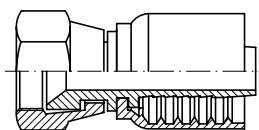

DN	THREAD ROSCA	Part n° Referencia	€
1/4"	7/16" 20h UNF	881420704	21,01
3/8"	9/16" 18h UNF	881420906	25,90
1/2"	3/4" 16h UNF	881421208	29,76
1/2"	1"1/16 12h UN	881421708	50,36
5/8"	7/8" 14h UNF	881421410	37,84
5/8"	1"1/16 12h UN	881421710	45,26
3/4"	1"1/16 12h UN	881421712	47,46
1"	1"5/16 12h UN	881422116	79,18
1"1/4"	1"5/8 12h UN	881422620	132,33
1"1/2"	1"7/8 12h UN	881423024	176,86
2"	2"1/2 12h UN	881424032	296,94

Hembras giratorias 90° una sola pieza JIC 37°

One piece JIC 37° Swivel female (90° Elbow)

Coude 90° femelle pré-sertie JIC 37°

Femmina 90° compatta JIC 37°

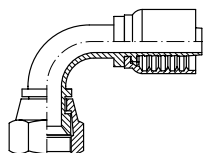

DN	THREAD ROSCA	Part n° Referencia	€
1/4"	7/16" 20h UNF	881380704	29,99
3/8"	9/16" 18h UNF	881380906	37,85
1/2"	3/4" 16h UNF	881381208	40,84
1/2"	7/8" 14h UNF	881381408	45,96
5/8"	7/8" 14h UNF	881381410	53,36
3/4"	1"1/16 12h UN	881381712	71,04
3/4"	1" 5/16 12h UN	881382112	95,39
1"	1"5/16 12h UN	881382116	112,54
1"1/4"	1"5/8 12h UN	881382620	187,11
1"1/2"	1"7/8 12h UN	881383024	269,65
2"	2"1/2 12h UN	881384032	577,13

Hembras giratorias 45° una sola pieza JIC 37°

One piece JIC 37° Swivel female (45° Elbow)

Coude 45° femelle pré-sertie JIC 37°

Femmina 45° compatta JIC 37°

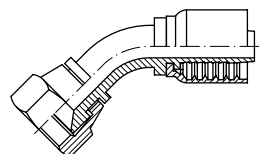

DN	THREAD ROSCA	Part n° Referencia	€
1/4"	7/16" 20h UNF	881390704	29,79
1/4"	9/16" 18h UNF	881390904	44,13
3/8"	9/16" 18h UNF	881390906	37,85
3/8"	3/4" 16h UNF	881391206	43,76
1/2"	3/4" 16h UNF	881391208	40,84
1/2"	7/8" 14h UNF	881391408	45,96
3/4"	1"1/16 12h UN	881391712	71,04
1"	1"5/16 12h UN	881392116	112,54
1"1/4"	1"5/8 12h UN	881392620	187,11
1"1/2"	1"7/8 12h UN	881393024	269,65
2"	2"1/2 12h UN	881394032	577,13

Machos una sola pieza rosca JIC 37°

One piece JIC 37° male

Mâle pré-serti JIC 37°

Maschio compatto JIC sede 37°

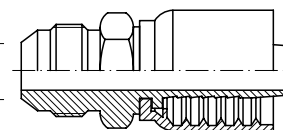

DN	THREAD ROSCA	Part n° Referencia	€
1/4"	7/16" 20h UNF	881400704	26,05
3/8"	9/16" 18h UNF	881400906	33,95
1/2"	3/4" 16h UNF	881401208	33,40
5/8"	7/8" 14h UNF	881401410	41,19
3/4"	1"1/16 12h UN	881401712	54,42
1"	1"5/16 12h UN	881402116	90,39
1"1/4"	1"5/8 12h UN	881402620	138,74
1"1/2"	1"7/8 12h UN	881403024	171,58
2"	2"1/2 12h UN	881404032	325,76

Hembras giratorias rectas una sola pieza JIC 37° doble hexagonal

One piece double hexagonal JIC 37° Swivel female

Femelle pré-sertie JIC 37° double hexagonal

Femmina diritta JIC 37° doppio esagono

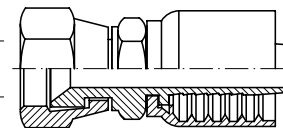

DN	THREAD ROSCA	Part n° Referencia	€
1/4"	7/16" 20h UNF	882420704	26,45
1/4"	1/2" 20h UNF	882420804	30,54
1/4"	9/16" 18h UNF	882420904	33,50
3/8"	9/16" 18h UNF	882420906	29,78
3/8"	3/4" 16h UNF	882421206	35,16
1/2"	3/4" 16h UNF	882421208	31,96
1/2"	7/8" 14h UNF	882421408	44,76
5/8"	7/8" 14h UNF	882421410	50,14
3/4"	1"1/16 12h UN	882421712	56,61
1"	1"1/16 12h UN	882421716	94,92
3/4"	1"5/16 12h UN	882422112	75,50
1"	1"5/16 12h UN	882422116	87,84
1"1/4"	1"5/8 12h UN	882422620	159,43
1"1/2"	1"7/8 12h UN	882423024	210,94
2"	2"1/2 12h UN	882424032	370,59

Conexiones una sola pieza Serie 43 R1AT/R2AT/1SN/2SN/R16/2SC/R17

One piece fittings 43 Series R1AT/R2AT/1SN/2SN/R16/2SC/R17

Embouts pré-sertis R1AT/R2AT/1SN/2SN/R16/2SC/R17 Série 43

Raccordi compatti R1AT/R2AT/1SN/2SN/R16/2SC/R17 Serie 43

Hembras giratorias rectas una sola pieza ORFS doble hexagonal

One piece double hexagonal ORFS Swivel female

Femelle pré-sertie ORFS double hexagonal

Femmina diritta compatta ORFS doppio esagono

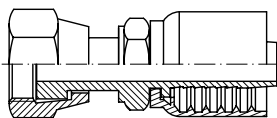

DN	THREAD ROSCA	Part n° Referencia	€
1/4"	9/16" 18h	889000904	39,40
1/4"	11/16-16	889001104	50,29
3/8"	11/16" 16h	889001106	47,54
3/8"	13/16-16	889001306	57,32
1/2"	13/16" 16h	889001308	52,82
1/2"	1-14	889001608	87,26
5/8"	1" 14h	889001610	72,81
1/2"	1 3/16-12	889001908	100,54
3/4"	1"3/16 12h	889001912	107,68
3/4"	1 7/16-12	889002312	122,96
1"	1"7/16 12h	889002316	118,62
1"1/4	1"11/16 12h	889002720	207,73
1"1/2	2" 12h	889003224	263,15

Hembras giratorias 90° una sola pieza ORFS

One piece ORFS Swivel female (90° Elbow)

Coude 90° femelle pré-sertie ORFS

Femmina 90° compatta ORFS

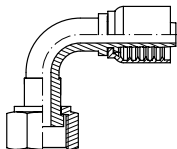

DN	THREAD ROSCA	Part n° Referencia	€
1/4"	9/16" 18h	889070904	67,76
1/4"	11/16-16	889071104	83,13
3/8"	11/16" 16h	889071106	82,23
3/8"	13/16-16	889071306	89,55
1/2"	13/16" 16h	889071308	90,81
1/2"	1-14	889071608	128,90
5/8"	1" 14h	889071610	118,00
3/4"	1"3/16 12h	889071912	151,86
3/4"	1 7/16-12	889072312	214,78
1"	1"7/16 12h	889072316	222,32
1"1/4	1"11/16 12h	889072720	316,71
1"1/2	2" 12h	889073224	826,70

Hembras giratorias 45° una sola pieza ORFS

One piece ORFS Swivel female (45° Elbow)

Coude 45° femelle pré-sertie ORFS

Femmina 45° compatta ORFS

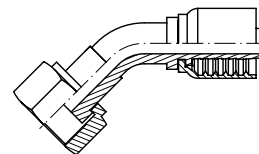

DN	THREAD ROSCA	Part n° Referencia	€
1/4"	11/16-16	889081104	83,13
3/8"	13/16-16	889081306	89,55
1/2"	1-14	889081608	128,90
3/4"	1 7/16-12	889082312	214,78
1/4"	9/16" 18h	889080904	67,76
3/8"	11/16" 16h	889081106	82,23
1/2"	13/16" 16h	889081308	90,81
5/8"	1" 14h	889081610	118,00
3/4"	1"3/16 12h	889081912	151,86
1"	1"7/16 12h	889082316	222,32
1"1/4	1"11/16 12h	889082720	316,71
1"1/2	2" 12h	889083224	826,70

Machos una sola pieza ORFS

One piece ORFS male

Mâle pré-serti ORFS

Maschio compatto ORFS

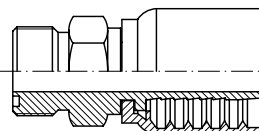

DN	THREAD ROSCA	Part n° Referencia	€
1/4"	9/16" 18h	889120904	45,60
3/8"	11/16" 16h	889121106	46,65
1/2"	13/16" 16h	889121308	55,76
5/8"	1" 14h	889121610	78,43
3/4"	1"3/16 12h	889121912	101,04
1"	1"7/16 12h	889122316	146,72
1"1/4	1"11/16 12h	889122720	211,33
1"1/2	2" 12h	889123224	300,84

Conexiones una sola pieza Serie 43 R1AT/R2AT/1SN/2SN/R16/2SC/R17

One piece fittings 43 Series R1AT/R2AT/1SN/2SN/R16/2SC/R17

Embouts pré-sertis R1AT/R2AT/1SN/2SN/R16/2SC/R17 Série 43

Raccordi compatti R1AT/R2AT/1SN/2SN/R16/2SC/R17 Serie 43

Hembras giratorias rectas una sola pieza rosca NPSM cono 60°

One piece NPSM Swivel female 60° cone

Femelle pré-sertie NPSM cone 60°

Femmina diritta compatta NPSM sede 60°

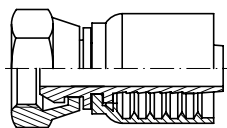

DN	THREAD ROSCA	Part n° Referencia	€
1/4"	1/4" 18h NPSM	882610404	23,82
3/8"	3/8" 18h NPSM	882610606	26,53
1/2"	1/2" 14h NPSM	882610808	32,71
3/4"	3/4" 14h NPSM	882611212	52,62
1"	1" - 11 1/2 h NPSM	882611616	85,50

Hembras giratorias 90° una sola pieza rosca NPSM cono 60°

One piece NPSM Swivel female 60° cone (90° Elbow)

Coude 90° femelle pré-sertie NPSM cone 60°

Femmina 90° compatta NPSM sede 60°

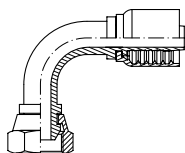

DN	THREAD ROSCA	Part n° Referencia	€
1/4"	1/4" 18h NPSM	882620404	33,63
3/8"	3/8" 18h NPSM	882620606	38,56
1/2"	1/2" 14h NPSM	882620808	46,82
3/4"	3/4" 14h NPSM	882621212	81,16
1"	1" - 11 1/2 h NPSM	882621616	117,52

Hembras giratorias 45° una sola pieza rosca NPSM cono 60°

One piece NPSM Swivel female 60° cone (45° Elbow)

Coude 45° femelle pré-sertie NPSM cone 60°

Femmina 45° compatta NPSM sede 60°

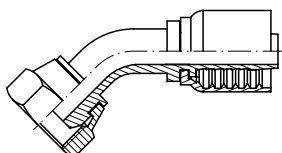

DN	THREAD ROSCA	Part n° Referencia	€
1/4"	1/4" 18h NPSM	882630404	33,63
3/8"	3/8" 18h NPSM	882630606	38,56
1/2"	1/2" 14h NPSM	882630808	46,82
3/4"	3/4" 14h NPSM	882631212	81,16
1"	1" - 11 1/2 h NPSM	882631616	117,52

Machos una sola pieza rosca cónica NPT

One piece NPT male pipe straight

Mâle pré-serti NPT

Maschio compatto conico NPT

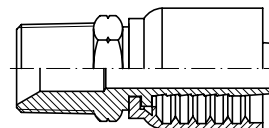

DN	THREAD ROSCA	Part n° Referencia	€
1/4"	1/8" NPT	881610204	27,42
1/4"	1/4" NPT	881610404	22,30
1/4"	3/8" NPT	881610604	27,93
3/8"	3/8" NPT	881610606	26,27
1/2"	3/8" NPT	881610608	36,52
1/4"	1/2" NPT	881610804	33,59
1/2"	1/2" NPT	881610808	32,24
5/8"	1/2" NPT	881610810	38,81
3/4"	1/2" NPT	881610812	53,44
1/2"	3/4" NPT	881611208	41,50
3/4"	3/4" NPT	881611212	46,68
3/4"	1" NPT	881611612	68,00
1"	1" NPT	881611616	80,19
1"1/4"	1"1/4" NPT	881612020	138,88
1"1/2"	1"1/2" NPT	881612424	164,99
2"	2" NPT	881613232	259,60

Hembras giratorias rectas una sola pieza rosca NPSM cono 60° doble hexagonal

One piece double hexagonal NPSM Swivel female 60° cone

Femelle pré-sertie NPSM cone 60° double hexagonal

Femmina diritta compatta NPSM sede 60° doppio esagono

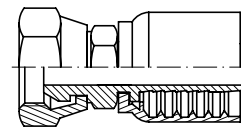

DN	THREAD ROSCA	Part n° Referencia	€
1/4"	1/4" 18h NPSM	883610404	36,27
3/8"	3/8" 18h NPSM	883610606	40,03
1/2"	1/2" 14h NPSM	883610808	43,57
3/4"	3/4" 14h NPSM	883611212	67,17
1"	1" - 11 1/2 h NPSM	883611616	108,96

Conexiones una sola pieza Serie 43 R1AT/R2AT/1SN/2SN/R16/2SC/R17

One piece fittings 43 Series R1AT/R2AT/1SN/2SN/R16/2SC/R17
 Embouts pré-sertis R1AT/R2AT/1SN/2SN/R16/2SC/R17 Série 43
 Raccordi compatti R1AT/R2AT/1SN/2SN/R16/2SC/R17 Serie 43

Bridas rectas una sola pieza SAE 3000 PSI

One piece 3000 PSI SAE Straight Flange / Code 61

Bride SAE droite pré-sertie série 3000 PSI

Flangia diritta compatta SAE 3000 PSI

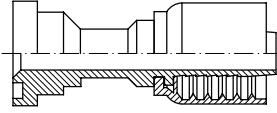

DN	Ø	Part n° Referencia	€
1/2"	30.2	881820808	53,68
1/2"	38.1	881821208	90,40
3/4"	38.1	881821212	76,81
3/4"	44.5	881821612	92,36
1"	44.5	881821616	105,17
1"	50.8	881822016	132,92
1"1/4	50.8	881822020	153,32
1"1/4	60.3	881822420	206,09
1"1/2	60.3	881822424	195,93
1"1/2	71.4	881823224	304,43
2"	71.4	881823232	298,74

Bridas 90° una sola pieza SAE 3000 PSI

One piece 3000 PSI SAE Flange (90° Elbow) / Code 61

Bride SAE coude 90° pré-sertie série 3000 PSI

Flangia 90° compatta SAE 3000 PSI

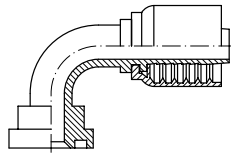

DN	Ø	Part n° Referencia	€
1/2"	30.2	881830808	73,12
1/2"	38.1	881831208	91,32
3/4"	38.1	881831212	105,25
3/4"	44.5	881831612	143,03
1"	44.5	881831616	140,27
1"1/4	44.5	881831620	215,93
1"	50.8	881832016	209,56
1"1/4	50.8	881832020	221,38
1"1/4	60.3	881832420	324,22
1"1/2	60.3	881832424	310,13
1"1/2	71.4	881833224	449,29
2"	71.4	881833232	441,99

Bridas 45° una sola pieza SAE 3000 PSI

One piece 3000 PSI SAE Flange (45° Elbow) / Code 61

Bride SAE coude 45° pré-sertie série 3000 PSI

Flangia 45° compatta SAE 3000 PSI

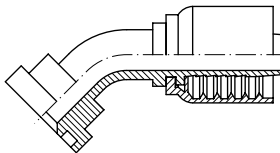

DN	Ø	Part n° Referencia	€
1/2"	30.2	881840808	73,12
1/2"	38.1	881841208	91,32
3/4"	38.1	881841212	105,25
3/4"	44.5	881841612	143,03
1"	44.5	881841616	140,27
1"	50.8	881842016	209,56
1"1/4	50.8	881842020	221,38
1"1/4	60.3	881842420	324,22
1"1/2	60.3	881842424	310,13
2"	71.4	881843232	441,99

Bridas rectas una sola pieza SAE 6000 PSI

One piece 6000 PSI SAE Straight Flange / Code 62

Bride SAE droite pré-sertie série 6000 PSI

Flangia diritta compatta SAE 6000 PSI

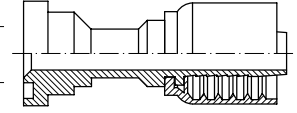

DN	Ø	Part n° Referencia	€
1/2"	31.8	882820808	60,75
3/4"	41.3	882821212	87,89
1"	47.6	882821616	118,51
1"1/4	54	882822020	177,45
1"1/2	63.5	882822424	217,89
2"	79.4	882823232	349,95

Bridas 90° una sola pieza SAE 6000 PSI

One piece 6000 PSI SAE Flange (90° Elbow) / Code 62

Bride SAE coude 90° pré-sertie série 6000 PSI

Flangia 90° compatta SAE 6000 PSI

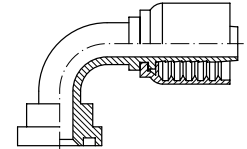

DN	Ø	Part n° Referencia	€
1/2"	31.8	882830808	73,35
3/4"	41.3	882831212	110,20
1"	47.6	882831616	167,37
1"1/4	54	882832020	224,01
1"1/2	63.5	882832424	339,47
2"	79.4	882833232	479,10

Bridas 45° una sola pieza SAE 6000 PSI

One piece 6000 PSI SAE Flange (45° Elbow) / Code 62

Bride SAE coude 45° pré-sertie série 6000 PSI

Flangia 45° compatta SAE 6000 PSI

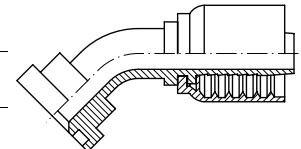

DN	Ø	Part n° Referencia	€
1/2"	31.8	882840808	73,35
3/4"	41.3	882841212	110,20
1"	47.6	882841616	167,37
1"1/4	54	882842020	224,01
1"1/2	63.5	882842424	339,47
2"	79.4	882843232	479,10

Conexiones una sola pieza Serie 43 R1AT/R2AT/1SN/2SN/R16/2SC/R17

One piece fittings 43 Series R1AT/R2AT/1SN/2SN/R16/2SC/R17

Embouts pré-sertis R1AT/R2AT/1SN/2SN/R16/2SC/R17 Série 43

Raccordi compatti R1AT/R2AT/1SN/2SN/R16/2SC/R17 Serie 43

Hembras giratorias rectas una sola pieza rosca Métrica cono 24° - DKO

One piece Metric female cone 24°

Femelle pré-sertie Métrique cono 24°

Femmina diritta compatta Metrica sede 24°

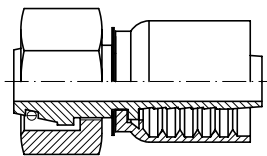

DN	PIPE TUBO	SERIE	THREAD ROSCA	Part nº Referencia	€
1/4"	6	L	M12x1.5	88804120604	21,80
1/4"	8	L	M14x1.5	88804140804	21,24
1/4"	10	L	M16x1.5	88804161004	22,27
3/8"	10	L	M16x1.5	88804161006	25,14
5/16"	10	L	M16x1.5	88804161005	25,00
3/8"	12	L	M18x1.5	88804181206	24,78
1/2"	15	L	M22x1.5	88804221508	30,88
1/2"	18	L	M26x1.5	88804261808	39,57
5/8"	18	L	M26x1.5	88804261810	40,14
3/4"	22	L	M30x2	88804302212	52,63
1"	28	L	M36x2	88804362816	85,95
1 1/4"	35	L	M45x2	88804453520	136,25
1 1/2"	42	L	M52x2	88804524224	169,99
1/4"	8	S	M16x1.5	88804160804	23,29
1/4"	10	S	M18x1.5	88804181004	23,06
3/8"	12	S	M20x1.5	88804201206	28,55
1/2"	16	S	M24x1.5	88804241608	30,70
5/8"	20	S	M30x2	88804302010	40,99
3/4"	20	S	M30x2	88804302012	63,70
3/4"	25	S	M36x2	88804362512	69,30
1"	25	S	M36x2	88804362516	94,61
1"	30	S	M42x2	88804423016	102,51
1 1/4"	38	S	M52x2	88804523820	161,90

Hembras giratorias 45° una sola pieza Métricas cono 24° - DKO 45°

One piece Metric female cone 24° (45° Elbow)

Coude 45° femelle pré-sertie Métrique cono 24°

Femmina 45° compatta Metrica sede 24°

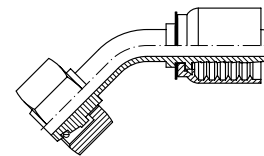

DN	PIPE TUBO	SERIE	THREAD ROSCA	Part nº Referencia	€
1/4"	6	L	M12x1.5	88306120604	32,18
1/4"	8	L	M14x1.5	88306140804	30,48
1/4"	10	L	M16x1.5	88306161004	34,01
5/16"	10	L	M16x1.5	88306161005	40,89
3/8"	10	L	M16x1.5	88306161006	38,36
3/8"	12	L	M18x1.5	88306181206	37,40
1/2"	15	L	M22x1.5	88306221508	42,72
1/2"	18	L	M26x1.5	88306261808	62,61
5/8"	18	L	M26x1.5	88306261810	61,00
3/4"	22	L	M30x2	88306302212	76,31
1"	28	L	M36x2	88306362816	117,16
1 1/4"	35	L	M45x2	88306453520	194,88
1 1/2"	42	L	M52x2	88306524224	281,32
1/4"	8	S	M16x1.5	88306160804	34,88
1/4"	10	S	M18x1.5	88306181004	35,27
3/8"	12	S	M20x1.5	88306201206	39,69
1/2"	16	S	M24x1.5	88306241608	44,08
5/8"	20	S	M30x2	88306302010	69,88
3/4"	20	S	M30x2	88306302012	79,52
3/4"	25	S	M36x2	88306362512	98,88
1"	25	S	M36x2	88306362516	126,25
1"	30	S	M42x2	88306423016	145,06
1 1/4"	38	S	M52x2	88306523820	239,63

Hembras giratorias 90° una sola pieza Métricas cono 24° - DKO 90°

One piece Metric female cone 24° (90° Elbow)

Coude 90° femelle pré-sertie Métrique cono 24°

Femmina 90° compatta Metrica sede 24°

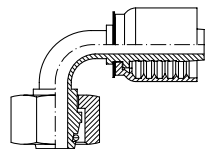

DN	PIPE TUBO	SERIE	THREAD ROSCA	Part nº Referencia	€
1/4"	6	L	M12x1.5	88305120604	32,18
1/4"	8	L	M14x1.5	88305140804	30,48
1/4"	10	L	M16x1.5	88305161004	34,01
5/16"	10	L	M16x1.5	88305161005	40,89
3/8"	12	L	M18x1.5	88305181206	37,40
1/2"	15	L	M22x1.5	88305221508	42,72
5/8"	18	L	M26x1.5	88305261810	61,00
3/4"	22	L	M30x2	88305302212	76,31
1"	28	L	M36x2	88305362816	117,16
1 1/4"	35	L	M45x2	88305453520	194,88
1 1/2"	42	L	M52x2	88305524224	281,32
1/4"	8	S	M16x1.5	88305160804	34,88
1/4"	10	S	M18x1.5	88305181004	35,27
5/16"	12	S	M20x1.5	88305201205	45,59
3/8"	12	S	M20x1.5	88305201206	39,69
1/2"	16	S	M24x1.5	88305241608	44,08
5/8"	20	S	M30x2	88305302010	69,88
3/4"	20	S	M30x2	88305302012	79,52
3/4"	25	S	M36x2	88305362512	98,88
1"	25	S	M36x2	88305362516	126,25
1"	30	S	M42x2	88305423016	146,92
1 1/4"	38	S	M52x2	88305523820	239,63

Machos una sola pieza rosca Métrica cono 24°

One piece Metric male cone 24°

Mâle pré-serti Métrique cono 24°

Maschio compatto Metrico sede 24°

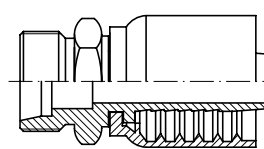

DN	PIPE TUBO	SERIE	THREAD ROSCA	Part nº Referencia	€
1/4"	6	L	M12x1.5	88203120604	29,84
1/4"	8	L	M14x1.5	88203140804	23,78
5/16"	10	L	M16x1.5	88203161005	33,44
3/8"	10	L	M16x1.5	88203161006	30,18
3/8"	12	L	M18x1.5	88203181206	23,63
1/2"	15	L	M22x1.5	88203221508	30,92
5/8"	18	L	M26x1.5	88203261810	40,03
3/4"	22	L	M30x2	88203302212	54,91
1"	28	L	M36x2	88203362816	88,71
1 1/4"	35	L	M45x2	88203453520	134,32
1 1/2"	42	L	M52x2	88203524224	187,98
1/4"	8	S	M16x1.5	88203160804	26,79
1/4"	10	S	M18x1.5	88203181004	33,47
3/8"	12	S	M20x1.5	88203201206	34,33
1/2"	16	S	M24x1.5	88203241608	31,43
5/8"	20	S	M30x2	88203302010	48,52
3/4"	20	S	M30x2	88203302012	56,92
1"	25	S	M36x2	88203362516	99,51
1"	30	S	M42x2	88203423016	117,83
1 1/4"	38	S	M52x2	88203523820	174,55

Conexiones una sola pieza Serie 43 R1AT/R2AT/1SN/2SN/R16/2SC/R17

One piece fittings 43 Series R1AT/R2AT/1SN/2SN/R16/2SC/R17

Embouts pré-sertis R1AT/R2AT/1SN/2SN/R16/2SC/R17 Série 43

Raccordi compatti R1AT/R2AT/1SN/2SN/R16/2SC/R17 Serie 43

Hembras giratorias rectas una sola pieza rosca BSP cono 60°

One piece BSP female 60° cone

Femelle pré-sertie BSP cono 60°

Femmina diritta compatta BSP sede 60°

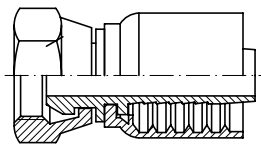

DN	THREAD ROSCA	Part n° Referencia	€
1/4"	1/4" BSP	881000404	19,05
1/4"	3/8" BSP	881000604	24,71
5/16"	3/8" BSP	881000605	26,50
3/8"	3/8" BSP	881000606	24,28
1/2"	3/8" BSP	881000608	27,84
3/8"	1/2" BSP	881000806	28,43
1/2"	1/2" BSP	881000808	27,92
5/8"	1/2" BSP	881000810	40,53
5/8"	5/8" BSP	881001010	45,68
1/2"	3/4" BSP	881001208	40,49
5/8"	3/4" BSP	881001210	40,53
3/4"	3/4" BSP	881001212	46,00
3/4"	1" BSP	881001612	63,19
1"	1" BSP	881001616	78,14
1"1/4	1"1/4 BSP	881002020	137,66
1"1/2	1"1/2 BSP	881002424	164,66
2"	2" BSP	881003232	252,41

Hembras giratorias 90° una sola pieza rosca BSP cono 60°

One piece BSP female cone 60° (90° Elbow)

Coude 90° femelle pré-sertie BSP cono 60°

Femmina 90° compatta BSP sede 60°

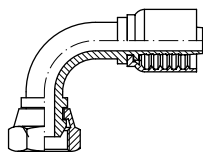

DN	THREAD ROSCA	Part n° Referencia	€
1/4"	1/4" BSP	881070404	28,74
3/8"	3/8" BSP	881070606	33,52
1/2"	3/8" BSP	881070608	63,73
3/8"	1/2" BSP	881070806	45,36
1/2"	1/2" BSP	881070808	40,55
5/8"	5/8" BSP	881071010	66,89
5/8"	3/4" BSP	881071210	67,45
3/4"	3/4" BSP	881071212	68,41
3/4"	1" BSP	881071612	90,09
1"	1" BSP	881071616	106,24
1"1/4	1"1/4 BSP	881072020	186,67
1"1/2	1"1/2 BSP	881072424	240,51
2"	2" BSP	881073232	428,83

Hembras giratorias 45° una sola pieza rosca BSP cono 60°

One piece BSP female cone 60° (45° Elbow)

Coude 45° femelle pré-sertie BSP cono 60°

Femmina 45° compatta BSP sede 60°

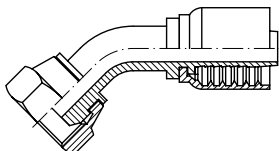

DN	THREAD ROSCA	Part n° Referencia	€
1/4"	1/4" BSP	881080404	28,74
3/8"	3/8" BSP	881080606	33,52
1/2"	1/2" BSP	881080808	40,55
3/4"	3/4" BSP	881081212	68,41
1"	1" BSP	881081616	106,24
1"1/4	1"1/4 BSP	881082020	186,67
1"1/2	1"1/2 BSP	881082424	240,51
2"	2" BSP	881083232	428,83

Machos una sola pieza rosca cilíndrica BSP cono 60°

One piece BSP male 60° cone

Mâle pré-serti BSP cono 60°

Maschio compatto cilindrico BSP sede 60°

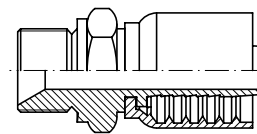

DN	THREAD ROSCA	Part n° Referencia	€
1/4"	1/4" BSP	881120404	22,31
3/8"	3/8" BSP	881120606	26,60
3/8"	1/2" BSP	881120806	30,94
1/2"	1/2" BSP	881120808	31,55
3/4"	3/4" BSP	881121212	48,07
3/4"	1" BSP	881121612	74,93
1"	1" BSP	881121616	93,95
1"1/4	1"1/4 BSP	881122020	144,76
1"1/2	1"1/2 BSP	881122424	171,69
2"	2" BSP	881123232	264,27

Hembras giratorias rectas una sola pieza rosca BSP cono 60° doble hexagonal

One piece double hexagonal BSP female 60° cone

Femelle pré-sertie BSP cono 60° double hexagonal

Femmina diritta compatta BSP sede 60° doppio esagono

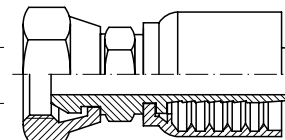

DN	THREAD ROSCA	Part n° Referencia	€
1/4"	1/4" BSP	884000404	30,89
3/8"	3/8" BSP	884000605	34,82
3/8"	3/8" BSP	884000606	33,59
1/2"	1/2" BSP	884000808	37,56
3/4"	3/4" BSP	884001212	62,50
1"	1" BSP	884001616	101,52
1"1/4	1"1/4 BSP	884002020	147,71
1"1/2	1"1/2 BSP	884002424	206,53
2"	2" BSP	884003232	337,07

Hembras giratorias rectas compactas rosca BSP asiento plano

One piece BSP female flat seat

Femelle pré-sertie BSP fond plat

Femmina diritta compatta BSP sede piana

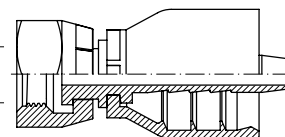

DN	THREAD ROSCA	Part n° Referencia	€
1/4"	1/4" BSP	882000404	23,82
3/8"	3/8" BSP	882000606	26,53
1/2"	1/2" BSP	882000808	32,71
3/4"	3/4" BSP	882001212	52,62
1"	1" BSP	882001616	80,26

Conexiones una sola pieza R7/ R8/ Elastómero malla metálica

One piece fittings R7/R8 & Elastomer Braid of steel wire
Embouts pré-sertis R7/R8 et Elastomère tresse métallique
Raccordi compatti serie R7/R8 e elastomero treccia metallica

Hembras giratorias rectas una sola pieza rosca JIC 37°

One piece JIC 37° female

Femelle pré-sertie JIC 37°

Femmina diritta compatta JIC 37°

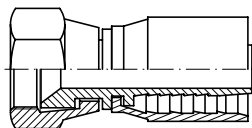

DN	THREAD ROSCA	Part nº Referencia	€
3/16"	7/16" 20h UNF	871420703	21,36
1/4"	7/16" 20h UNF	871420704	18,76
1/4"	9/16" 18h UNF	871420904	21,48
5/16"	9/16" 18h UNF	871420905	21,48
3/8"	9/16" 18h UNF	871420906	22,38
1/2"	3/4" 16h UNF	871421208	26,27
1/2"	7/8" 14h UNF	871421408	29,46
3/4"	1"1/16 12h UN	871421712	40,74
1"	1"5/16 12h UN	871422116	66,65

Hembras giratorias 90° una sola pieza rosca JIC 37°

One piece JIC 37° female (90° Elbow)

90° Femelle pré-sertie JIC 37°

Femmina 90° compatta JIC 37°

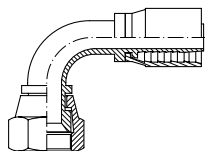

DN	THREAD ROSCA	Part nº Referencia	€
3/16"	7/16" 20h UNF	871380703	34,94
1/4"	7/16" 20h UNF	871380704	27,92
3/8"	9/16" 18h UNF	871380906	33,52
1/2"	3/4" 16h UNF	871381208	37,17
3/4"	1"1/16 12h UN	871381712	64,32
1"	1"5/16 12h UN	871382116	100,01

Hembras giratorias 45° una sola pieza rosca JIC 37°

One piece JIC 37° female (45° Elbow)

45° Femelle pré-sertie JIC 37°

Femmina 45° compatta JIC 37°

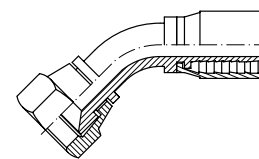

DN	THREAD ROSCA	Part nº Referencia	€
1/4"	7/16" 20h UNF	871390704	27,92
3/8"	9/16" 18h UNF	871390906	33,52
1/2"	3/4" 16h UNF	871391208	37,17
3/4"	1"1/16 12h UN	871391712	64,32
1"	1"5/16 12h UN	871392116	100,01

Machos una sola pieza rosca JIC 37°

One piece JIC 37° male

Mâle pré-serti JIC 37°

Maschio compatto JIC sede 37°

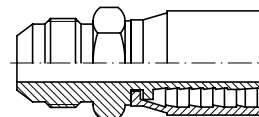

DN	THREAD ROSCA	Part nº Referencia	€
1/4"	7/16" 20h UNF	871400704	23,80
3/8"	9/16" 18h UNF	871400906	30,04
1/2"	3/4" 16h UNF	871401208	29,58
3/4"	1"1/16 12h UN	871401712	45,75
1"	1"5/16 12h UN	871402116	77,86

Hembras giratorias rectas una sola pieza rosca JIC 37° doble hexagonal

One piece double hexagonal JIC 37° female

Femelle pré-sertie JIC 37° double hexagonal

Femmina diritta JIC 37° doppio esagono

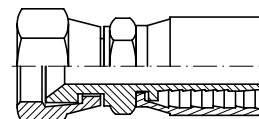

DN	THREAD ROSCA	Part nº Referencia	€
1/4"	7/16" 20h UNF	872420704	23,10
3/8"	9/16" 18h UNF	872420906	26,39
1/2"	3/4" 16h UNF	872421208	28,98
1/2"	7/8" 14h UNF	872421408	43,19
3/4"	1"1/16 12h UN	872421712	49,89
1"	1"5/16 12h UN	872422116	77,83

Conexiones una sola pieza R7/ R8/ Elastómero malla metálica

One piece fittings R7/R8 & Elastomer Braid of steel wire
Embouts pré-sertis R7/R8 et Elastomère tresse métallique
Raccordi compatti serie R7/R8 e elastomero treccia metallica

Hembras giratorias rectas una sola pieza rosca ORFS doble hexagonal

One piece double hexagonal ORFS female

Femelle pré-sertie ORFS double hexagonal

Femmina diritta compatta ORFS

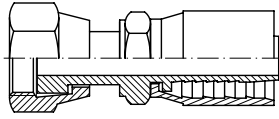

DN	THREAD ROSCA	Part nº Referencia	€
1/4"	9/16"-18h	879000904	37,55
3/8"	11/16"-16h	879001106	44,17
1/2"	13/16"-16h	879001308	49,86
3/4"	1"3/16-12h	879001912	100,96
1"	1"7/16-12h	879002316	109,62

Hembras giratorias 45° una sola pieza rosca ORFS

One piece ORFS female (45° Elbow)

45° Femelle pré-sertie ORFS

Femmina 45° compatta ORFS

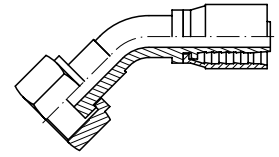

DN	THREAD ROSCA	Part nº Referencia	€
1/4"	9/16"-18h	879080904	65,91
3/8"	11/16"-16h	879081106	78,86
1/2"	13/16"-16h	879081308	87,32
3/4"	1"3/16-12h	879081912	145,14
1"	1"7/16-12h	879082316	213,32

Hembras giratorias 90° una sola pieza rosca ORFS

One piece ORFS female (90° Elbow)

90° Femelle pré-sertie ORFS

Femmina 90° compatta ORFS

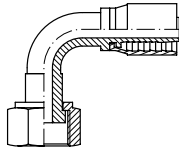

DN	THREAD ROSCA	Part nº Referencia	€
1/4"	9/16"-18h	879070904	65,91
3/8"	11/16"-16h	879071106	78,86
1/2"	13/16"-16h	879071308	87,32
3/4"	1"3/16-12h	879071912	145,14
1"	1"7/16-12h	879072316	213,32

Machos compactos rosca ORFS

One piece ORFS male

Mâle pré-serti ORFS

Maschio compatto ORFS

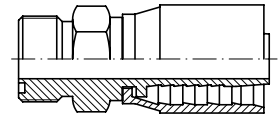

DN	THREAD ROSCA	Part nº Referencia	€
1/4"	9/16"-18h	879120904	43,35
3/8"	11/16"-16h	879121106	42,80
1/2"	13/16"-16h	879121308	52,27
3/4"	1"3/16-12h	879121912	94,32
1"	1"7/16-12h	879122316	137,72

Hembras giratorias rectas una sola pieza rosca NPSM cono 60°

One piece NPSM female 60° cone

Femelle pré-sertie NPSM cone 60°

Femmina diritta compatta NPSM sede 60°

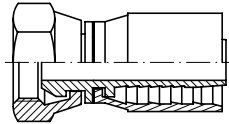

DN	THREAD ROSCA	Part nº Referencia	€
1/4"	1/4" 18h NPSM	872610404	21,95
3/8"	3/8" 18h NPSM	872610606	22,69
1/2"	1/2" 14h NPSM	872610808	29,22
3/4"	3/4" 14h NPSM	872611212	45,90
1"	1" - 11 1/2 h NPSM	872611616	72,97

Hembras giratorias 45° una sola pieza rosca NPSM cono 60°

One piece NPSM female 60° cone (45° Elbow)

45° Femelle pré-sertie NPSM cone 60°

Femmina 45° compatta NPSM sede 60°

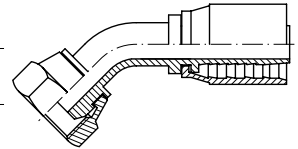

DN	THREAD ROSCA	Part nº Referencia	€
1/4"	1/4" 18h NPSM	872630404	31,76
3/8"	3/8" 18h NPSM	872630606	34,72
1/2"	1/2" 14h NPSM	872630808	43,33
3/4"	3/4" 14h NPSM	872631212	74,44
1"	1" - 11 1/2 h NPSM	872631616	104,99

Hembras giratorias 90° una sola pieza rosca NPSM cono 60°

One piece NPSM female 60° cone (90° Elbow)

90° Femelle pré-sertie NPSM cone 60°

Femmina 90° compatta NPSM sede 60°

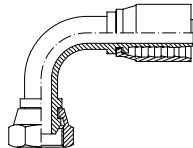

DN	THREAD ROSCA	Part nº Referencia	€
1/4"	1/4" 18h NPSM	872620404	31,76
3/8"	3/8" 18h NPSM	872620606	34,72
1/2"	1/2" 14h NPSM	872620808	43,33
3/4"	3/4" 14h NPSM	872621212	74,44
1"	1" - 11 1/2 h NPSM	872621616	104,99

Machos una sola pieza rosca cónica NPT

One piece NPT male pipe straight

Mâle pré-serti NPT

Maschio compatto conico NPT

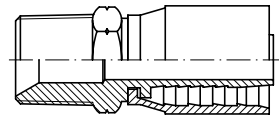

DN	THREAD ROSCA	Part nº Referencia	€
1/4"	1/4" NPT	871610404	19,09
3/8"	3/8" NPT	871610606	21,43
1/2"	1/2" NPT	871610808	28,04
3/4"	3/4" NPT	871611212	40,44
1"	1" NPT	871611616	66,98

Conexiones una sola pieza R7/ R8/ Elastómero malla metálica

One piece fittings R7/R8 & Elastomer Braid of steel wire
Embouts pré-sertis R7/R8 et Elastomère tresse métallique
Raccordi compatti serie R7/R8 e elastomero treccia metallica

Hembras giratorias rectas una sola pieza rosca NPSM cono 60° doble hexagonal

One piece double hexagonal NPSM female 60° cone

Femelle pré-sertie NPSM cono 60° double hexagonal

Femmina diritta compatta NPSM sede 60° doppio esagono

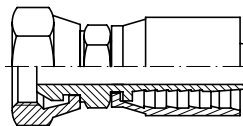

DN	THREAD ROSCA	Part nº Referencia	€
1/4"	1/4" NPSM	873610404	34,40
3/8"	3/8" 18h NPSM	873610606	36,19
1/2"	1/2" 14h NPSM	873610808	40,59
3/4"	3/4" NPSM	873611212	60,45
1"	1" - 11 1/2 h NPSM	873611616	96,43

Hembras giratorias rectas una sola pieza rosca Métrica cono 24° - DKO

One piece Metric female 24° cone

Femelle pré-sertie Métrique cono 24°

Femmina diritta compatta Metrica sede 24°

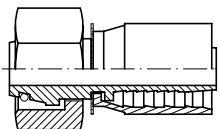

DN	PIPE TUBO	SERIE	THREAD ROSCA	Part nº Referencia	€
1/4"	8	L	M14x1.5	87804140804	17,46
3/8"	12	L	M18x1.5	87804181206	20,94
1/2"	15	L	M22x1.5	87804221508	27,92
3/4"	22	L	M30x2	87804302212	45,91
1"	28	L	M36x2	87804362816	72,52
1/4"	8	S	M16x1.5	87804160804	21,16
1/4"	10	S	M18x1.5	87804181004	20,93
3/8"	12	S	M20x1.5	87804201206	24,10
1/2"	16	S	M24x1.5	87804241608	27,21
3/4"	20	S	M30x2	87804302012	56,98
3/4"	25	S	M36x2	87804362512	62,58
1"	30	S	M42x2	87804423016	89,08

Hembras giratorias 90° una sola pieza Métricas cono 24° - DKO 90°

One piece Metric female 24° cone (90° Elbow)

90° Femelle pré-sertie Métrique cono 24°

Femmina 90° compatta Metrica sede 24°

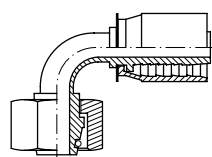

DN	PIPE TUBO	SERIE	THREAD ROSCA	Part nº Referencia	€
1/4"	8	L	M14x1.5	87305140804	28,23
3/8"	12	L	M18x1.5	87305181206	33,56
1/2"	15	L	M22x1.5	87305221508	39,83
3/4"	22	L	M30x2	87305302212	69,61
1"	28	L	M36x2	87305362816	104,63
1/4"	8	S	M16x1.5	87305160804	33,01
1/4"	10	S	M18x1.5	87305181004	33,01
3/8"	12	S	M20x1.5	87305201206	36,04
1/2"	16	S	M24x1.5	87305241608	40,80
3/4"	25	S	M36x2	87305362512	92,16
1"	30	S	M42x2	87305423016	132,53

Hembras giratorias 45° una sola pieza Métricas cono 24° - DKO 45°

One piece Metric female 24° cone (45° Elbow)

45° Femelle pré-sertie Métrique cono 24°

Femmina 45° compatta Metrica sede 24°

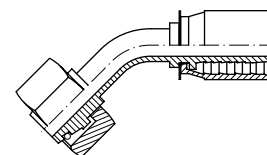

DN	PIPE TUBO	SERIE	THREAD ROSCA	Part nº Referencia	€
1/4"	8	L	M14x1.5	87306140804	28,23
1/4"	10	S	M18x1.5	87306181004	33,01
3/8"	12	L	M18x1.5	87306181206	33,56
1/2"	15	L	M22x1.5	87306221508	39,83
3/4"	22	L	M30x2	87306302212	69,61
1"	28	L	M36x2	87306362816	104,63
1/4"	8	S	M16x1.5	87306160804	33,01
3/8"	12	S	M20x1.5	87306201206	36,04
1/2"	16	S	M24x1.5	87306241608	40,80
3/4"	25	S	M36x2	87306362512	92,16
1"	30	S	M42x2	87306423016	132,53

Machos una sola pieza rosca Métrica cono 24°

One piece Metric male 24° cone

Mâle pré-serti Métrique cono 24°

Maschio compatto Metrico sede 24°

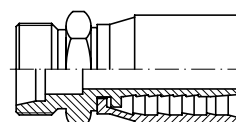

DN	PIPE TUBO	SERIE	THREAD ROSCA	Part nº Referencia	€
1/4"	8	L	M14x1.5	87203140804	21,53
3/8"	12	L	M18x1.5	87203181206	19,83
1/2"	15	L	M22x1.5	87203221508	27,44
3/4"	22	L	M30x2	87203302212	48,19
1"	28	L	M36x2	87203362816	76,18
1/4"	8	S	M16x1.5	87203160804	24,53
3/8"	12	S	M20x1.5	87203201206	30,49
1/2"	16	S	M24x1.5	87203241608	28,10
3/4"	25	S	M36x2	87203362512	64,50
1"	30	S	M42x2	87203423016	105,30

Conexiones una sola pieza R7/ R8/ Elastómero malla metálica

One piece fittings R7/R8 & Elastomer Braid of steel wire
 Embouts pré-sertis R7/R8 et Elastomère tresse métallique
 Raccordi compatti serie R7/R8 e elastomero treccia metallica

Hembras giratorias rectas una sola pieza rosca BSP cono 60°

One piece BSP female 60° cone

Femelle pré-sertie BSP cone 60°

Femmina diritta compatta BSP sede 60°

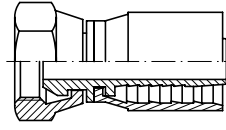

DN	THREAD ROSCA	Part n° Referencia	€
1/4"	1/4" BSP	871000404	16,80
3/8"	3/8" BSP	871000606	20,78
1/2"	1/2" BSP	871000808	24,27
3/4"	3/4" BSP	871001212	39,28
1"	1" BSP	871001616	64,71

Machos una sola pieza rosca cilíndrica BSP cono 60°

One piece BSP male 60° cone

Mâle pré-serti BSP cone 60°

Maschio compatto cilindrico BSP sede 60°

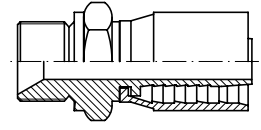

DN	THREAD ROSCA	Part n° Referencia	€
1/4"	1/4" BSP	871120404	20,06
3/8"	3/8" BSP	871120606	21,72
1/2"	1/2" BSP	871120808	27,00
3/4"	3/4" BSP	871121212	41,35
1"	1" BSP	871121616	80,52

Hembras giratorias 90° una sola pieza rosca BSP cono 60°

One piece BSP female 60° cone (90° Elbow)

90° Femelle pré-sertie BSP cone 60°

Femmina 90° compatta BSP sede 60°

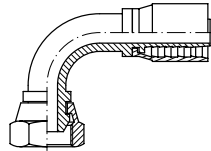

DN	THREAD ROSCA	Part n° Referencia	€
1/4"	1/4" BSP	871070404	26,68
3/8"	3/8" BSP	871070606	30,29
1/2"	1/2" BSP	871070808	37,30
3/4"	3/4" BSP	871071212	61,69
1"	1" BSP	871071616	93,71

Hembras giratorias rectas una sola pieza rosca BSP cono 60° doble hexagonal

One piece double hexagonal BSP female 60° cone

Femelle pré-sertie BSP cone 60° double hexagonal

Femmina diritta compatta BSP sede 60° doppio esagono

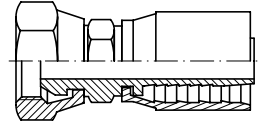

DN	THREAD ROSCA	Part n° Referencia	€
1/4"	1/4" BSP	874000404	28,64
3/8"	3/8" BSP	874000606	30,60
1/2"	1/2" BSP	874000808	34,07
3/4"	3/4" BSP	874001212	55,78
1"	1" BSP	874001616	88,99

Hembras giratorias 45° una sola pieza rosca BSP cono 60°

One piece BSP female 60° cone (45° Elbow)

45° Femelle pré-sertie BSP cone 60°

Femmina 45° compatta BSP sede 60°

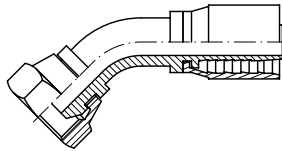

DN	THREAD ROSCA	Part n° Referencia	€
1/4"	1/4" BSP	871080404	26,68
3/8"	3/8" BSP	871080606	30,29
1/2"	1/2" BSP	871080808	37,30
3/4"	3/4" BSP	871081212	61,69
1"	1" BSP	871081616	93,71

Conexiones una sola pieza PTFE Liso / R14

One piece fittings for Smooth PTFE/ R14
Embouts pré-sertis pour PTFE lisse/ R14
Raccordi compatti per PTFE liscio/ R14

Hembras giratorias rectas una sola pieza rosca JIC 37°

One piece JIC 37° female

Femelle pré-sertie JIC 37°

Femmina diritta compatta JIC 37°

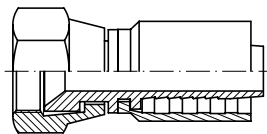

DN	THREAD ROSCA	Part n° Referencia	€
1/4"	7/16" 20h UNF	861420704	17,66
1/4"	1/2" 20h UNF	861420804	19,02
5/16"	1/2" 20h UNF	861420805	22,26
5/16"	9/16" 18h UNF	861420905	20,92
3/8"	9/16" 18h UNF	861420906	20,79
1/2"	3/4" 16h UNF	861421208	24,88
3/4"	1"1/16 12h UN	861421712	37,74
1"	1"5/16 12h UN	861422116	63,25

Hembras giratorias 90° una sola pieza rosca JIC 37°

One piece JIC 37° female (90° Elbow)

90° Femelle pré-sertie JIC 37°

Femmina 90° compatta JIC 37°

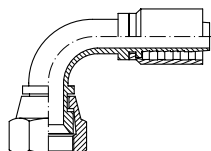

DN	THREAD ROSCA	Part n° Referencia	€
1/4"	7/16" 20h UNF	861380704	26,64
5/16"	9/16" 18h UNF	861380905	33,70
3/8"	9/16" 18h UNF	861380906	32,26
1/2"	3/4" 16h UNF	861381208	35,78
3/4"	1"1/16 12h UN	861381712	61,32
1"	1"5/16 12h UN	861382116	96,61

Hembras giratorias 45° una sola pieza rosca JIC 37°

One piece JIC 37° female (45° Elbow)

45° Femelle pré-sertie JIC 37°

Femmina 45° compatta JIC 37°

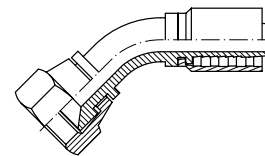

DN	THREAD ROSCA	Part n° Referencia	€
1/4"	7/16" 20h UNF	861390704	26,44
3/8"	9/16" 18h UNF	861390906	32,26
1/2"	3/4" 16h UNF	861391208	35,78
3/4"	1"1/16 12h UN	861391712	61,32
1"	1"5/16 12h UN	861392116	96,61

Machos una sola pieza rosca JIC 37°

One piece JIC 37° male

Mâle pré-serti JIC 37°

Maschio compatto JIC sede 37°

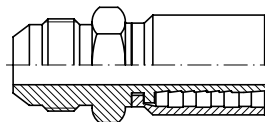

DN	THREAD ROSCA	Part n° Referencia	€
1/4"	7/16" 20h UNF	861400704	22,70
3/8"	9/16" 18h UNF	861400906	28,78
1/2"	3/4" 16h UNF	861401208	27,68
3/4"	1"1/16 12h UN	861401712	42,75
1"	1"5/16 12h UN	861402116	74,46

Hembras giratorias rectas una sola pieza rosca JIC 37° doble hexagonal

One piece JIC 37° double hexagonal female

Femelle pré-sertie JIC 37° double hexagonal

Femmina diritta JIC 37° doppio esagono

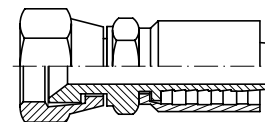

DN	THREAD ROSCA	Part n° Referencia	€
3/16"	7/16" 20h UNF	862420703	25,82
1/4"	7/16" 20h UNF	862420704	21,92
5/16"	1/2" 20h UNF	862420805	32,30
3/8"	9/16" 18h UNF	862420906	24,67
1/2"	3/4" 16h UNF	862421208	27,08
5/8"	1"1/16 12h UN	862421710	51,73
3/4"	1"1/16 12h UN	862421712	46,89
1"	1"5/16 12h UN	862422116	74,43

Conexiones una sola pieza PTFE Liso / R14

One piece fittings for Smooth PTFE/ R14
 Embouts pré-sertis pour PTFE lisse/ R14
 Raccordi compatti per PTFE liscio/ R14

Hembras giratorias rectas una sola pieza rosca ORFS doble hexagonal

One piece double hexagonal ORFS female

Femelle pré-sertie ORFS double hexagonal

Femmina diritta compatta ORFS

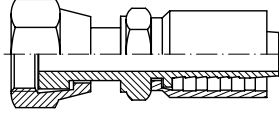

DN	THREAD ROSCA	Part n° Referencia	€
1/4"	9/16"-18h	869000904	36,05
3/8"	11/16"-16h	869001106	42,43
1/2"	13/16"-16h	869001308	47,94
3/4"	1"3/16-12h	869001912	97,96
1"	1"7/16-12h	869002316	106,22

Hembras giratorias 90° una sola pieza rosca ORFS

One piece ORFS female (90° Elbow)

90° Femelle pré-sertie ORFS

Femmina 90° compatta ORFS

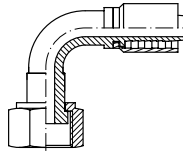

DN	THREAD ROSCA	Part n° Referencia	€
1/4"	9/16"-18h	869070904	64,41
3/8"	11/16"-16h	869071106	77,12
1/2"	13/16"-16h	869071308	85,93
3/4"	1"3/16-12h	869071912	141,61
1"	1"7/16-12h	869072316	209,92

Hembras giratorias 45° una sola pieza rosca ORFS

One piece ORFS female (45° Elbow)

45° Femelle pré-sertie ORFS

Femmina 45° compatta ORFS

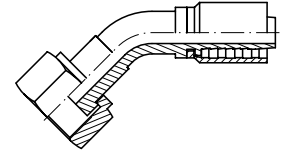

DN	THREAD ROSCA	Part n° Referencia	€
1/4"	9/16"-18h	869080904	64,41
3/8"	11/16"-16h	869081106	77,12
1/2"	13/16"-16h	869081308	85,93
3/4"	1"3/16-12h	869081912	141,61
1"	1"7/16-12h	869082316	209,92

Machos una sola pieza rosca ORFS

One piece ORFS male

Mâle pré-serti ORFS

Maschio compatto ORFS

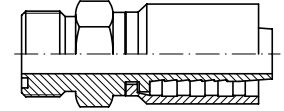

DN	THREAD ROSCA	Part n° Referencia	€
1/4"	9/16"-18h	869120904	42,25
3/8"	11/16"-16h	869121106	41,54
1/2"	13/16"-16h	869121308	50,88
3/4"	1"3/16-12h	869121912	91,32
1"	1"7/16-12h	869122316	134,32

Conexiones una sola pieza PTFE Liso / R14

One piece fittings for Smooth PTFE/R14
Embouts pré-sertis pour PTFE lisse/ R14
Raccordi compatti per PTFE liscio/ R14

Hembras giratorias rectas una sola pieza rosca NPSM cono 60°

One piece NPSM female 60° cone

Femelle pré-sertie NPSM cone 60°

Femmina diritta compatta NPSM sede 60°

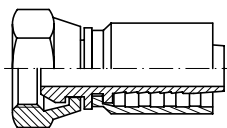

DN	THREAD ROSCA	Part n° Referencia	€
1/4"	1/4" 18h NPSM	862610404	20,47
3/8"	3/8" 18h NPSM	862610606	21,42
1/2"	1/2" 14h NPSM	862610808	27,83
3/4"	3/4" 14h NPSM	862611212	42,90
1"	1" - 11 1/2 h NPSM	862611616	69,57

Hembras giratorias 90° una sola pieza rosca NPSM cono 60°

One piece NPSM female 60° cone (90° Elbow)

90° Femelle pré-sertie NPSM cone 60°

Femmina 90° compatta NPSM sede 60°

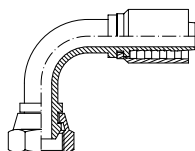

DN	THREAD ROSCA	Part n° Referencia	€
1/4"	1/4" 18h NPSM	862620404	30,28
3/8"	3/8" 18h NPSM	862620606	33,45
1/2"	1/2" 14h NPSM	862620808	41,94
3/4"	3/4" 14h NPSM	862621212	71,43
1"	1" - 11 1/2 h NPSM	862621616	101,59

Hembras giratorias 45° una sola pieza rosca NPSM cono 60°

One piece NPSM female 60° cone (45° Elbow)

45° Femelle pré-sertie NPSM cone 60°

Femmina 45° compatta NPSM sede 60°

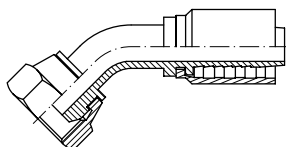

DN	THREAD ROSCA	Part n° Referencia	€
1/4"	1/4" 18h NPSM	862630404	30,28
3/8"	3/8" 18h NPSM	862630606	33,45
1/2"	1/2" 14h NPSM	862630808	41,94
3/4"	3/4" 14h NPSM	862631212	71,43
1"	1" - 11 1/2 h NPSM	862631616	101,59

Machos una sola pieza rosca cónica NPT

One piece NPT male pipe straight

Mâle pré-serti NPT

Maschio compatto conico NPT

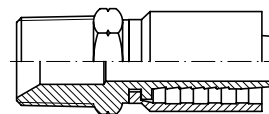

DN	THREAD ROSCA	Part n° Referencia	€
1/4"	1/4" NPT	861610404	18,00
3/8"	3/8" NPT	861610606	20,16
1/2"	1/2" NPT	861610808	26,14
3/4"	3/4" NPT	861611212	37,44
1"	1" NPT	861611616	63,58

Hembras giratorias rectas una sola pieza rosca NPSM cono 60° doble hexagonal

One piece double hexagonal NPSM female 60° cone

Femelle pré-sertie NPSM cone 60° double hexagonal

Femmina diritta compatta NPSM sede 60° doppio esagono

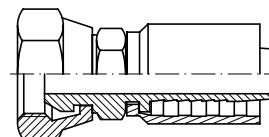

DN	THREAD ROSCA	Part n° Referencia	€
1/4"	1/4" NPSM	863610404	32,92
3/8"	3/8" 18h NPSM	863610606	34,92
1/2"	1/2" 14h NPSM	863610808	38,69
3/4"	3/4" NPSM	863611212	57,45
1"	1" - 11 1/2 h NPSM	863611616	93,03

Conexiones una sola pieza PTFE Liso / R14

One piece fittings for Smooth PTFE/R14
 Embouts pré-sertis pour PTFE lisse/R14
 Raccordi compatti per PTFE liscio/R14

Hembras giratorias rectas una sola pieza rosca Métrica cono 24° - DKO

One piece Metric female 24° cone

Femelle pré-sertie Métrique cone 24°

Femmina diritta compatta Metrica sede 24°

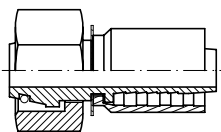

DN	PIPE TUBO	SERIE	THREAD ROSCA	Part n° Referencia	€
1/4"	8	L	M14x1.5	86804140804	16,35
3/8"	12	L	M18x1.5	86804181206	19,67
1/2"	15	L	M22x1.5	86804221508	26,00
3/4"	22	L	M30x2	86804302212	42,38
1"	28	L	M36x2	86804362816	69,12
1/4"	8	S	M16x1.5	86804160804	19,94
3/8"	12	S	M20x1.5	86804201206	22,38
1/2"	16	S	M24x1.5	86804241608	25,82
3/4"	25	S	M36x2	86804362512	59,58
1"	30	S	M42x2	86804423016	85,68

Hembras giratorias 45° una sola pieza rosca Métrica cono 24° - DKO 45°

One piece Metric female 24° cone (45° Elbow)

45° Femelle pré-sertie Métrique cone 24°

Femmina 45° compatta Metrica sede 24°

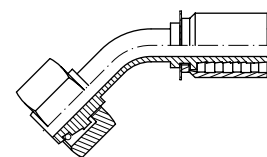

DN	PIPE TUBO	SERIE	THREAD ROSCA	Part n° Referencia	€
1/4"	8	L	M14x1.5	86306140804	27,13
3/8"	12	L	M18x1.5	86306181206	32,29
1/2"	15	L	M22x1.5	86306221508	37,84
3/4"	22	L	M30x2	86306302212	66,61
1"	28	L	M36x2	86306362816	101,23
1/4"	8	S	M16x1.5	86306160804	31,53
3/8"	12	S	M20x1.5	86306201206	34,58
1/2"	16	S	M24x1.5	86306241608	39,20
3/4"	25	S	M36x2	86306362512	89,16
1"	30	S	M42x2	86306423016	129,13

Hembras giratorias 90° una sola pieza rosca Métrica cono 24° - DKO 90°

One piece Metric female 24° cone (90° Elbow)

90° Femelle pré-sertie Métrique cone 24°

Femmina 90° compatta Metrica sede 24°

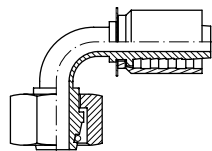

DN	PIPE TUBO	SERIE	THREAD ROSCA	Part n° Referencia	€
1/4"	8	L	M14x1.5	86305140804	27,13
3/8"	12	L	M18x1.5	86305181206	32,29
1/2"	15	L	M22x1.5	86305221508	37,84
3/4"	22	L	M30x2	86305302212	66,61
1"	28	L	M36x2	86305362816	101,23
1/4"	8	S	M16x1.5	86305160804	31,53
3/8"	12	S	M20x1.5	86305201206	34,58
1/2"	16	S	M24x1.5	86305241608	39,20
3/4"	25	S	M36x2	86305362512	89,16
1"	30	S	M42x2	86305423016	129,13

Machos compactos rosca Métrica cono 24°

One piece Metric male 24° cone

Mâle pré-serti Métrique cone 24°

Maschio compatto Metrico sede 24°

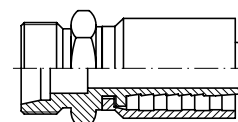

DN	PIPE TUBO	SERIE	THREAD ROSCA	Part n° Referencia	€
1/4"	8	L	M14x1.5	86203140804	20,43
3/8"	12	L	M18x1.5	86203181206	18,52
1/2"	15	L	M22x1.5	86203221508	26,04
3/4"	22	L	M30x2	86203302212	45,18
1"	28	L	M36x2	86203362816	72,78
1/4"	8	S	M16x1.5	86203160804	23,44
3/8"	12	S	M20x1.5	86203201206	29,22
1/2"	16	S	M24x1.5	86203241608	26,55
3/4"	25	S	M36x2	86203362512	61,49
1"	30	S	M42x2	86203423016	101,90

Conexiones una sola pieza PTFE Liso / R14

One piece fittings for Smooth PTFE/R14
Embouts pré-sertis pour PTFE lisse/ R14
Raccordi compatti per PTFE liscio/ R14

Hembras giratorias rectas una sola pieza rosca BSP cono 60°

One piece BSP female 60° cone

Femelle pré-sertie BSP cone 60°

Femmina diritta compatta BSP sede 60°

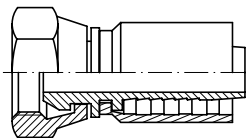

DN	THREAD ROSCA	Part n° Referencia	€
3/16"	1/4" BSP	861000403	20,46
1/4"	1/4" BSP	861000404	15,70
3/8"	3/8" BSP	861000606	19,17
1/2"	1/2" BSP	861000808	22,78
3/4"	3/4" BSP	861001212	36,28
1"	1" BSP	861001616	61,31

Hembras giratorias 90° una sola pieza rosca BSP cono 60°

One piece BSP female 60° cone (90° Elbow)

90° Femelle pré-sertie BSP cone 60°

Femmina 90° compatta BSP sede 60°

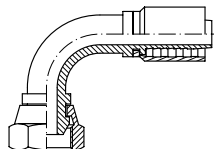

DN	THREAD ROSCA	Part n° Referencia	€
1/4"	1/4" BSP	861070404	25,57
3/8"	3/8" BSP	861070606	29,02
1/2"	1/2" BSP	861070808	35,93
3/4"	3/4" BSP	861071212	59,14
1"	1" BSP	861071616	90,97

Hembras giratorias 45° una sola pieza rosca BSP cono 60°

One piece BSP female 60° cone (45° Elbow)

45° Femelle pré-sertie BSP cone 60°

Femmina 45° compatta BSP sede 60°

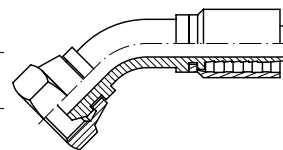

DN	THREAD ROSCA	Part n° Referencia	€
1/4"	1/4" BSP	861080404	25,57
3/8"	3/8" BSP	861080606	29,02
1/2"	1/2" BSP	861080808	35,93
3/4"	3/4" BSP	861081212	59,14
1"	1" BSP	861081616	90,97

Machos una sola pieza rosca cilíndrica BSP cono 60°

One piece BSP male 60° cone

Mâle pré-serti BSP cone 60°

Maschio compatto cilindrico BSP sede 60°

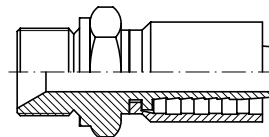

DN	THREAD ROSCA	Part n° Referencia	€
1/4"	1/4" BSP	861120404	18,96
3/8"	3/8" BSP	861120606	20,12
1/2"	1/2" BSP	861120808	25,61
3/4"	3/4" BSP	861121212	38,35
1"	1" BSP	861121616	77,12

Hembras giratorias rectas una sola pieza rosca BSP cono 60° doble hexagonal

One piece double hexagonal BSP female 60° cone

Femelle pré-sertie BSP cone 60° double hexagonal

Femmina diritta compatta BSP sede 60° doppio esagono

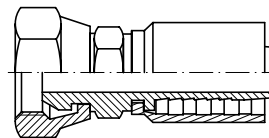

DN	THREAD ROSCA	Part n° Referencia	€
1/4"	1/4" BSP	864000404	27,54
3/8"	3/8" BSP	864000606	29,34
1/2"	1/2" BSP	864000808	32,68
3/4"	3/4" BSP	864001212	52,78
1"	1" BSP	864001616	85,59

Conexiones una sola pieza PTFE Corrugado

One piece fittings for convoluted PTFE
Emboutis pré-sertis pour PTFE convoluté
Raccordi compatti per PTFE convoluto

Hembras giratorias rectas una sola pieza rosca JIC 37°

One piece JIC 37° female

Femelle pré-sertie JIC 37°

Femmina diritta compatta JIC 37°

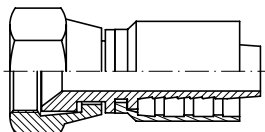

DN	THREAD ROSCA	Part n° Referencia	€
1/4"	7/16" 20h UNF	851420704	18,85
5/16"	1/2" 20h UNF	851420805	20,64
3/8"	9/16" 18h UNF	851420906	20,99
1/2"	3/4" 16h UNF	851421208	26,73
3/4"	1" 1/16 12h UN	851421712	40,76
1"	1" 5/16 12h UN	851422116	66,17
1" 1/4"	1" 5/8 12h UN	851422620	102,68

Hembras giratorias 90° una sola pieza rosca JIC 37°

One piece JIC 37° female (90° Elbow)

90° Femelle pré-sertie JIC 37°

Femmina 90° compatta JIC 37°

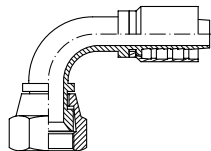

DN	THREAD ROSCA	Part n° Referencia	€
1/4"	7/16" 20h UNF	851380704	27,83
3/8"	9/16" 18h UNF	851380906	32,47
1/2"	3/4" 16h UNF	851381208	37,63
3/4"	1" 1/16 12h UN	851381712	64,35
1"	1" 5/16 12h UN	851382116	99,53

Hembras giratorias 45° una sola pieza rosca JIC 37°

One piece JIC 37° female (45° Elbow)

45° Femelle pré-sertie JIC 37°

Femmina 45° compatta JIC 37°

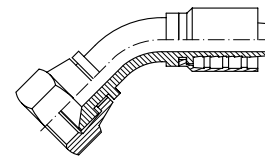

DN	THREAD ROSCA	Part n° Referencia	€
1/4"	7/16" 20h UNF	851390704	27,83
3/8"	9/16" 18h UNF	851390906	32,47
1/2"	3/4" 16h UNF	851391208	37,63
3/4"	1" 1/16 12h UN	851391712	64,35
1"	1" 5/16 12h UN	851392116	99,53

Machos una sola pieza rosca JIC 37°

One piece JIC 37° male

Mâle pré-serti JIC 37°

Maschio compatto JIC sede 37°

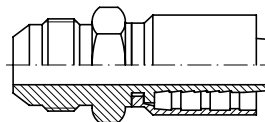

DN	THREAD ROSCA	Part n° Referencia	€
1/4"	7/16" 20h UNF	851400704	23,89
3/8"	9/16" 18h UNF	851400906	28,98
1/2"	3/4" 16h UNF	851401208	29,53
3/4"	1" 1/16 12h UN	851401712	45,78
1"	1" 5/16 12h UN	851402116	77,38

Hembras giratorias rectas una sola pieza rosca JIC 37° doble hexagonal

One piece JIC 37° double hexagonal female

Femelle pré-sertie JIC 37° double hexagonal

Femmina diritta JIC 37° doppio esagono

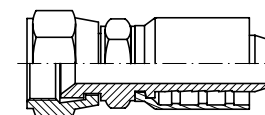

DN	THREAD ROSCA	Part n° Referencia	€
1/4"	7/16" 20h UNF	852420704	23,11
3/8"	9/16" 18h UNF	852420906	24,88
1/2"	3/4" 16h UNF	852421208	28,93
3/4"	1" 1/16 12h UN	852421712	49,91
1"	1" 5/16 12h UN	852422116	77,35

Conexiones una sola pieza PTFE Corrugado

One piece fittings for convoluted PTFE
 Embouts pré-sertis pour PTFE convoluté
 Raccordi compatti per PTFE convoluto

Hembras giratorias rectas una sola pieza rosca ORFS doble hexagonal

One piece double hexagonal ORFS female

Femelle pré-sertie ORFS double hexagonal

Femmina diritta compatta ORFS

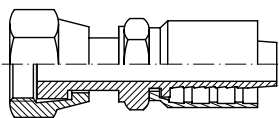

DN	THREAD ROSCA	Part n° Referencia	€
1/4"	9/16"-18h	859000904	37,24
3/8"	11/16"-16h	859001106	42,33
1/2"	13/16"-16h	859001308	49,79
3/4"	1"3/16-12h	859001912	100,98
1"	1"7/16-12h	859002316	109,14

Hembras giratorias 90° una sola pieza rosca ORFS

One piece ORFS female (90° Elbow)

90° Femelle pré-sertie ORFS

Femmina 90° compatta ORFS

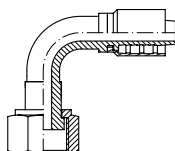

DN	THREAD ROSCA	Part n° Referencia	€
1/4"	9/16"-18h	859070904	65,60
3/8"	11/16"-16h	859071106	77,02
1/2"	13/16"-16h	859071308	87,78
3/4"	1"3/16-12h	859071912	144,52
1"	1"7/16-12h	859072316	212,84

Hembras giratorias 45° una sola pieza rosca ORFS

One piece ORFS female (45° Elbow)

45° Femelle pré-sertie ORFS

Femmina 45° compatta ORFS

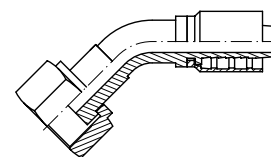

DN	THREAD ROSCA	Part n° Referencia	€
1/4"	9/16"-18h	859080904	65,60
3/8"	11/16"-16h	859081106	77,02
1/2"	13/16"-16h	859081308	87,78
3/4"	1"3/16-12h	859081912	144,52
1"	1"7/16-12h	859082316	212,84

Machos una sola pieza rosca ORFS

One piece ORFS male

Mâle pré-serti ORFS

Maschio compatto ORFS

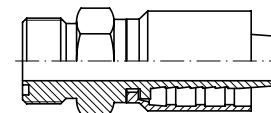

DN	THREAD ROSCA	Part n° Referencia	€
1/4"	9/16"-18h	859120904	43,44
3/8"	11/16"-16h	859121106	41,74
1/2"	13/16"-16h	859121308	52,73
3/4"	1"3/16-12h	859121912	94,35
1"	1"7/16-12h	859122316	137,24

Conexiones una sola pieza PTFE Corrugado

One piece fittings for convoluted PTFE
Embouts pré-sertis pour PTFE convoluté
Raccordi compatti per PTFE convoluto

Hembras giratorias rectas una sola pieza rosca NPSM cono 60°

One piece NPSM female 60° cone

Femelle pré-sertie NPSM cone 60°

Femmina diritta compatta NPSM sede 60°

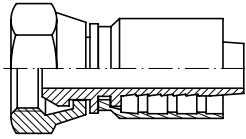

DN	THREAD ROSCA	Part n° Referencia	€
1/4"	1/4" 18h NPSM	852610404	21,66
3/8"	3/8" 18h NPSM	852610606	21,63
1/2"	1/2" 14h NPSM	852610808	29,68
3/4"	3/4" 14h NPSM	852611212	45,92
1"	1" - 11 1/2 h NPSM	852611616	72,49

Hembras giratorias 90° una sola pieza rosca NPSM cono 60°

One piece NPSM female 60° cone (90° Elbow)

90° Femelle pré-sertie NPSM cone 60°

Femmina 90° compatta NPSM sede 60°

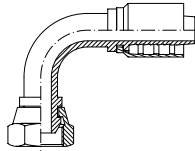

DN	THREAD ROSCA	Part n° Referencia	€
1/4"	1/4" 18h NPSM	852620404	31,47
3/8"	3/8" 18h NPSM	852620606	33,66
1/2"	1/2" 14h NPSM	852620808	43,79
3/4"	3/4" 14h NPSM	852621212	74,46
1"	1" - 11 1/2 h NPSM	852621616	104,51

Hembras giratorias 45° una sola pieza rosca NPSM cono 60°

One piece NPSM female 60° cone (45° Elbow)

45° Femelle pré-sertie NPSM cone 60°

Femmina 45° compatta NPSM sede 60°

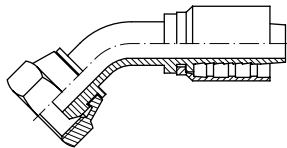

DN	THREAD ROSCA	Part n° Referencia	€
1/4"	1/4" 18h NPSM	852630404	31,47
3/8"	3/8" 18h NPSM	852630606	33,66
1/2"	1/2" 14h NPSM	852630808	43,79
3/4"	3/4" 14h NPSM	852631212	74,46
1"	1" - 11 1/2 h NPSM	852631616	104,51

Machos una sola pieza rosca cónica NPT

One piece NPT male pipe straight

Mâle pré-serti NPT

Maschio compatto conico NPT

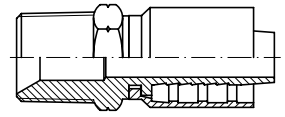

DN	THREAD ROSCA	Part n° Referencia	€
1/4"	1/4" NPT	851610404	19,19
3/8"	3/8" NPT	851610606	20,37
1/2"	1/2" NPT	851610808	27,99
3/4"	3/4" NPT	851611212	40,47
1"	1" NPT	851611616	66,50

Hembras giratorias rectas una sola pieza rosca NPSM cono 60° doble hexagonal

One piece double hexagonal NPSM female 60° cone

Femelle pré-sertie NPSM cone 60° double hexagonal

Femmina diritta compatta NPSM sede 60° doppio esagono

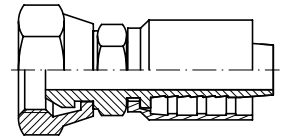

DN	THREAD ROSCA	Part n° Referencia	€
1/4"	1/4" NPSM	853610404	34,11
3/8"	3/8" 18h NPSM	853610606	35,13
1/2"	1/2" 14h NPSM	853610808	40,54
3/4"	3/4" NPSM	853611212	60,47
1"	1" - 11 1/2 h NPSM	853611616	95,95

Conexiones una sola pieza PTFE Corrugado

One piece fittings for convoluted PTFE
 Embouts pré-sertis pour PTFE convoluto
 Raccordi compatti per PTFE convoluto

Hembras giratorias rectas una sola pieza rosca Métrica cono 24° - DKO

One piece Metric female 24° cone

Femelle pré-sertie Métrique cone 24°

Femmina diritta compatta Metrica sede 24°

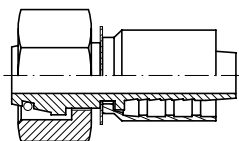

DN	PIPE TUBO	SERIE	THREAD ROSCA	Part n° Referencia	€
1/4"	8	L	M14x1.5	85804140804	17,54
3/8"	12	L	M18x1.5	85804181206	19,88
1/2"	15	L	M22x1.5	85804221508	27,85
3/4"	22	L	M30x2	85804302212	45,29
1"	28	L	M36x2	85804362816	72,04
1/4"	8	S	M16x1.5	85804160804	21,13
3/8"	12	S	M20x1.5	85804201206	22,59
1/2"	16	S	M24x1.5	85804241608	27,67
3/4"	25	S	M36x2	85804362512	62,60
1"	30	S	M42x2	85804423016	88,60

Hembras giratorias 45° una sola pieza rosca Métrica cono 24° - DKO 45°

One piece Metric female 24° cone (45° Elbow)

45° Femelle pré-sertie Métrique cone 24°

Femmina 45° compatta Metrica sede 24°

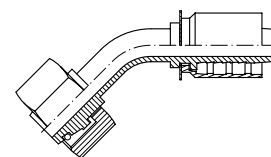

DN	PIPE TUBO	SERIE	THREAD ROSCA	Part n° Referencia	€
1/4"	8	L	M14x1.5	85306140804	28,32
3/8"	12	L	M18x1.5	85306181206	32,50
1/2"	15	L	M22x1.5	85306221508	40,29
3/4"	22	L	M30x2	85306302212	69,63
1"	28	L	M36x2	85306362816	104,15
1/4"	8	S	M10x1.5	85306160804	32,72
3/8"	12	S	M20x1.5	85306201206	34,79
1/2"	16	S	M24x1.5	85306241608	41,05
3/4"	25	S	M36x2	85306362512	92,18
1"	30	S	M42x2	85306423016	132,05

Hembras giratorias 90° una sola pieza rosca Métrica cono 24° - DKO 90°

One piece Metric female 24° cone (90° Elbow)

90° Femelle pré-sertie Métrique cone 24°

Femmina 90° compatta Metrica sede 24°

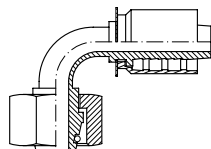

DN	PIPE TUBO	SERIE	THREAD ROSCA	Part n° Referencia	€
1/4"	8	L	M14x1.5	85305140804	28,32
3/8"	12	L	M18x1.5	85305181206	32,50
1/2"	15	L	M22x1.5	85305221508	40,29
3/4"	22	L	M30x2	85305302212	69,63
1"	28	L	M36x2	85305362816	104,15
1/4"	8	S	M16x1.5	85305160804	32,72
3/8"	12	S	M20x1.5	85305201206	34,79
1/2"	16	S	M24x1.5	85305241608	41,05
3/4"	25	S	M36x2	85305362512	92,18
1"	30	S	M42x2	85305423016	132,05

Machos una sola pieza rosca Métrica cono 24°

One piece Metric male 24° cone

Mâle pré-serti Métrique cone 24°

Maschio compatto Metrico sede 24°

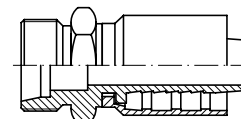

DN	PIPE TUBO	SERIE	THREAD ROSCA	Part n° Referencia	€
1/4"	8	L	M14x1.5	85203140804	21,62
3/8"	12	L	M18x1.5	85203181206	18,73
1/2"	15	L	M22x1.5	85203221508	27,89
3/4"	22	L	M30x2	85203302212	48,21
1"	28	L	M36x2	85203362816	75,70
1/4"	8	S	M16x1.5	85203160804	24,63
3/8"	12	S	M20x1.5	85203201206	29,43
1/2"	16	S	M24x1.5	85203241608	28,40
3/4"	25	S	M36x2	85203362512	64,52
1"	30	S	M42x2	85203423016	104,82

Conexiones una sola pieza PTFE Corrugado

One piece fittings for convoluted PTFE
 Embouts pré-sertis pour PTFE convoluté
 Raccordi compatti per PTFE convoluto

Hembras giratorias rectas una sola pieza rosca BSP cono 60°

One piece BSP female 60° cone

Femelle pré-sertie BSP cone 60°

Femmina diritta compatta BSP sede 60°

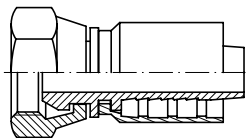

DN	THREAD ROSCA	Part n° Referencia	€
1/4"	1/4" BSP	851000404	16,89
3/8"	3/8" BSP	851000606	19,38
1/2"	1/2" BSP	851000808	24,63
3/4"	3/4" BSP	851001212	39,31
1"	1" BSP	851001616	64,23

Hembras giratorias 90° una sola pieza rosca BSP cono 60°

One piece BSP female 60° cone (90° Elbow)

90° Femelle pré-sertie BSP cone 60°

Femmina 90° compatta BSP sede 60°

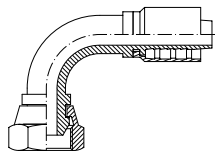

DN	THREAD ROSCA	Part n° Referencia	€
1/4"	1/4" BSP	851070404	26,76
3/8"	3/8" BSP	851070606	29,23
1/2"	1/2" BSP	851070808	37,78
3/4"	3/4" BSP	851071212	62,16
1"	1" BSP	851071616	93,89

Hembras giratorias 45° una sola pieza rosca BSP cono 60°

One piece BSP female 60° cone (45° Elbow)

45° Femelle pré-sertie BSP cone 60°

Femmina 45° compatta BSP sede 60°

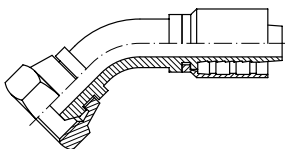

DN	THREAD ROSCA	Part n° Referencia	€
1/4"	1/4" BSP	851080404	26,76
3/8"	3/8" BSP	851080606	29,23
1/2"	1/2" BSP	851080808	37,78
3/4"	3/4" BSP	851081212	62,16
1"	1" BSP	851081616	93,89

Machos una sola pieza rosca cilíndrica BSP cono 60°

One piece BSP male 60° cone

Mâle pré-serti BSP cone 60°

Maschio compatto cilindrico BSP sede 60°

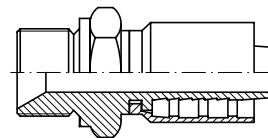

DN	THREAD ROSCA	Part n° Referencia	€
1/4"	1/4" BSP	851120404	20,15
3/8"	3/8" BSP	851120606	20,33
1/2"	1/2" BSP	851120808	27,46
3/4"	3/4" BSP	851121212	41,38
1"	1" BSP	851121616	80,04

Hembras giratorias rectas una sola pieza rosca BSP cono 60° doble hexagonal

One piece double hexagonal BSP female 60° cone

Femelle pré-sertie BSP cone 60° double hexagonal

Femmina diritta compatta BSP sede 60° doppio esagono

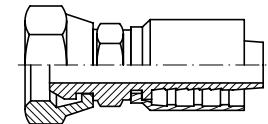

DN	THREAD ROSCA	Part n° Referencia	€
1/4"	1/4" BSP	854000404	28,73
3/8"	3/8" BSP	854000606	29,54
1/2"	1/2" BSP	854000808	34,53
3/4"	3/4" BSP	854001212	55,80
1"	1" BSP	854001616	88,51

Conexiones una sola pieza Serie BW R12/4SP/4SH

One piece fittings BW Series R12/4SP/4SH
Embouts pré-sertis R12/4SP/4SH Série BW
Raccordi Compatti R12/4SP/4SH Serie BW

Hembras giratorias rectas una sola pieza JIC 37° doble hexagonal

One piece double hexagonal JIC 37° Swivel female

Femelle pré-sertie JIC 37° double hexagonal

Femmina diritta compatta JIC 37° doppio esagono

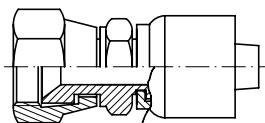

DN	THREAD ROSCA	Part n° Referencia	€
1/2"	3/4" 16h UNF	Z682421208	55,47
5/8"	7/8" 14h UNF	Z682421410	71,56
3/4"	1"1/16 12h UN	Z682421712	91,92
1"	1"5/16 12h UN	Z682422116	131,96
1"1/4	1"5/8 12h UN	Z682422620	278,06
1"1/2	1"7/8 12h UN	Z682423024	414,60
2"	2"1/2 12h UN	Z682424032	617,68

Machos una sola pieza rosca JIC 37° con junta

One piece JIC 37° male with o'ring

Mâle pré-serti JIC 37° avec joint torique

Maschio compatto JIC 37° con o'ring

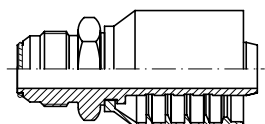

DN	THREAD ROSCA	Part n° Referencia	€
1/2"	3/4" 16h UNF	Z681411208	57,27
5/8"	7/8" 14h UNF	Z681411410	65,65
3/4"	1"1/16 12h UN	Z681411712	85,01
1"	1"5/16 12h UN	Z681412116	112,79
1"1/4	1"5/8 12h UN	Z681412620	163,73
1"1/2	1"7/8 12h UN	Z681413024	207,06
2"	2"1/2 12h UN	Z681414032	381,46

Hembras giratorias 90° una sola pieza rosca JIC 37°

One piece JIC 37° Swivel female (90° Elbow)

Coude 90° femelle pré-sertie JIC 37°

Femmina gir. compatta 90° JIC 37°

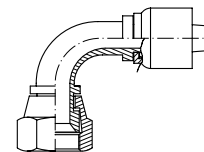

DN	THREAD ROSCA	Part n° Referencia	€
1/2"	3/4" 16h UNF	Z681381208	62,41
5/8"	7/8" 14h UNF	Z681381410	75,80
3/4"	1"1/16 12h UN	Z681381712	94,80
1"	1"5/16 12h UN	Z681382116	130,62
1"1/4	1"5/8 12h UN	Z681382620	201,84
1"1/2	1"7/8 12h UN	Z681383024	290,97
2"	2"1/2 12h UN	Z681384032	538,06

Hembras giratorias 45° una sola pieza rosca JIC 37°

One piece JIC 37° Swivel female (45° Elbow)

Coude 45° femelle pré-sertie JIC 37°

Femmina gir. compatta 45° JIC 37°

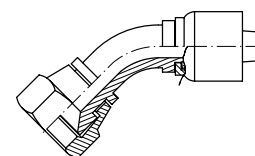

DN	THREAD ROSCA	Part n° Referencia	€
1/2"	3/4" 16h UNF	Z681391208	62,41
5/8"	7/8" 14h UNF	Z681391410	75,80
3/4"	1"1/16 12h UN	Z681391712	94,80
1"	1"5/16 12h UN	Z681392116	130,62
1"1/4	1"5/8 12h UN	Z681392620	201,84
1"1/2	1"7/8 12h UN	Z681393024	290,97
2"	2"1/2 12h UN	Z681394032	538,06

Conexiones una sola pieza Serie BW R12/4SP/4SH

One piece fittings BW Series R12/4SP/4SH
Embouts pré-sertis R12/4SP/4SH Série BW
Raccordi Compatti R12/4SP/4SH Serie BW

Hembras giratorias rectas una sola pieza ORFS doble hexagonal

One piece ORFS Swivel female straight double hexagonal

Femelle pré-sertie droite ORFS double hexagonale

Femmina diritta compatta ORFS doppio esagono

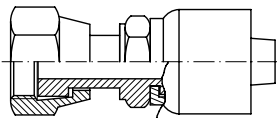

DN	THREAD ROSCA	Part n° Referencia	€
1/2"	13/16"-16h	Z689011308	76,16
5/8"	1"-14h	Z689011610	101,53
3/4"	1"3/16-12h	Z689011912	112,84
1"	1"7/16-12h	Z689012316	159,20
1"1/4	1" 11/16-12h	Z689012720	219,17
1"1/2	2"-12h	Z689013224	315,54

Hembras giratorias 90° una sola pieza ORFS

One piece ORFS Swivel female (90° Elbow)

Coude 90° femelle pré-sertie ORFS

Femmina 90° compatta ORFS

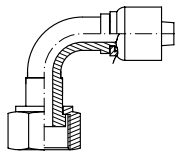

DN	THREAD ROSCA	Part n° Referencia	€
1/2"	13/16"-16h	Z689071308	121,66
5/8"	1"-14h	Z689071610	160,27
3/4"	1"3/16-12h	Z689071912	253,80
1"	1"7/16-12h	Z689072316	364,26
1"1/4	1" 11/16-12h	Z689072720	517,26
1"1/2	2"-12h	Z689073224	1.403,88

Hembras giratorias rectas una sola pieza NPSM cono 60° doble hexagonal con junta

One piece double hexagonal NPSM female 60° cone with o'ring

Femelle pré-sertie NPSM cono 60° double hexagonal avec joint torique

Femmina diritta compatta NPSM cono 60° doppio esagono con guarnizione

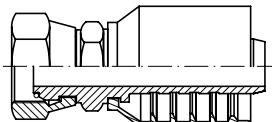

DN	THREAD ROSCA	Part n° Referencia	€
1/2"	1/2" 14h NPSM	Z684610808	60,22
1"	1" NPSM	Z684611616	141,58
1"1/4	1"1/4 NPSM	Z684612020	267,45
1"1/2	1"1/2 NPSM	Z684612424	364,32
2"	2" NPSM	Z684613232	536,10

Machos compactos ORFS

One piece ORFS Male

Mâle pré-serti ORFS

Maschio compatto ORFS

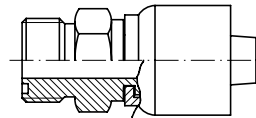

DN	THREAD ROSCA	Part n° Referencia	€
1/2"	13/16"-16h	Z689121308	74,59
5/8"	1"-14h	Z689121610	108,39
3/4"	1"3/16-12h	Z689121912	163,40
1"	1"7/16-12h	Z689122316	235,72
1"1/4	1" 11/16-12h	Z689122720	337,46
1"1/2	2"-12h	Z689123224	495,61

Hembras giratorias 45° una sola pieza ORFS

One piece ORFS Swivel female (45° Elbow)

Coude 45° femelle pré-sertie ORFS

Femmina 45° compatta ORFS

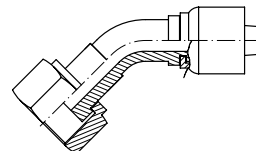

DN	THREAD ROSCA	Part n° Referencia	€
1/2"	13/16"-16h	Z689081308	121,66
5/8"	1"-14h	Z689081610	160,27
3/4"	1"3/16-12h	Z689081912	253,80
1"	1"7/16-12h	Z689082316	364,26
1"1/4	1" 11/16-12h	Z689082720	517,26
1"1/2	2"-12h	Z689083224	1.403,88

Machos cónicos una sola pieza NPT

One piece NPT Male pipe straight

Mâle pré-serti conique NPT

Maschio compatto conico NPT

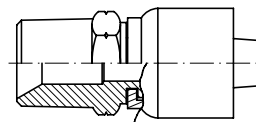

DN	THREAD ROSCA	Part n° Referencia	€
1/2"	1/2" NPT	Z681610808	53,36
3/4"	3/4" NPT	Z681611212	72,87
1"	1" NPT	Z681611616	98,37
1"1/4	1"1/4 NPT	Z681612020	164,23
1"1/2	1"1/2 NPT	Z681612424	237,86
2"	2" NPT	Z681613232	424,59

Conexiones una sola pieza Serie BW R12/4SP/4SH

One piece fittings BW Series R12/4SP/4SH
Embouts pré-sertis R12/4SP/4SH Série BW
Raccordi Compatti R12/4SP/4SH Serie BW

Bridas rectas una sola pieza SAE 3000 PSI

One piece 3000 PSI SAE Straight Flange / Code 61

Bride SAE droite pré-sertie série 3000 PSI

Flangia diritta compatta SAE 3000

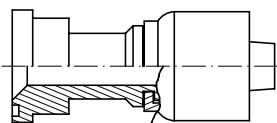

DN	Ø	Part n° Referencia	€
1/2"	30.2	Z681820808	82,48
5/8"	38.1	Z681821210	102,62
3/4"	38.1	Z681821212	96,03
1"	44.5	Z681821616	120,78
1"1/4	50.8	Z681822020	195,80
1"1/2	60.3	Z681822424	262,67
2"	71.4	Z681823232	403,20

Bridas 90° una sola pieza SAE 3000 PSI

One piece 3000 PSI SAE Flange (90° Elbow) / Code 61

Bride SAE coude 90° pré-sertie série 3000 PSI

Flangia 90° compatta SAE 3000

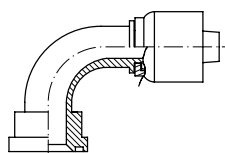

DN	Ø	Part n° Referencia	€
1/2"	30.2	Z681830808	102,55
5/8"	38.1	Z681831210	145,69
3/4"	38.1	Z681831212	122,87
1"	44.5	Z681831616	175,35
1"1/4	50.8	Z681832020	235,83
1" 1/2	60.3	Z681832424	382,12
2"	71.4	Z681833232	545,81

Bridas 45° una sola pieza SAE 3000 PSI

One piece 3000 PSI SAE Flange (45° Elbow) / Code 61

Bride SAE coude 45° pré-sertie série 3000 PSI

Flangia 45° compatta SAE 3000

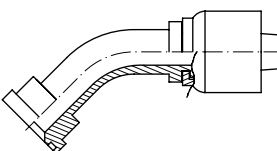

DN	Ø	Part n° Referencia	€
1/2"	30.2	Z681840808	102,55
5/8"	38.1	Z681841210	145,69
3/4"	38.1	Z681841212	122,87
1"	44.5	Z681841616	175,35
1"1/4	50.8	Z681842020	235,83
1" 1/2	60.3	Z681842424	382,12
2"	71.4	Z681843232	545,81

Bridas rectas una sola pieza SAE 6000 PSI

One piece 6000 PSI SAE Straight Flange / Code 62

Bride SAE droite pré-sertie série 6000 PSI

Flangia diritta compatta SAE 6000

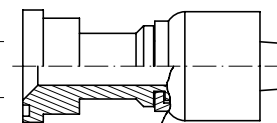

DN	Ø	Part n° Referencia	€
1/2"	30.2	Z682820808	86,44
5/8"	38.1	Z682821210	128,88
3/4"	41.3	Z682821212	104,66
1"	47.6	Z682821616	128,66
1"1/4	54	Z682822020	197,69
1"1/2	63.5	Z682822424	264,80
2"	79.4	Z682823232	415,60

Bridas 90° una sola pieza SAE 6000 PSI

One piece 6000 PSI SAE Flange (90° Elbow) / Code 62

Bride SAE coude 90° pré-sertie série 6000 PSI

Flangia 90° compatta SAE 6000

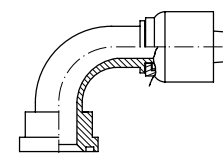

DN	Ø	Part n° Referencia	€
1/2"	30.2	Z682830808	102,82
5/8"	38.1	Z682831210	155,55
3/4"	41.3	Z682831212	129,15
1"	47.6	Z682831616	176,85
1"1/4	54	Z682832020	242,23
1"1/2	63.5	Z682832424	387,72
2"	79.4	Z682833232	559,29

Bridas 45° una sola pieza SAE 6000 PSI

One piece 6000 PSI SAE Flange (45° Elbow) / Code 62

Bride SAE coude 45° pré-sertie série 6000 PSI

Flangia 45° compatta SAE 6000

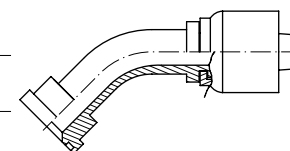

DN	Ø	Part n° Referencia	€
1/2"	30.2	Z682840808	102,82
5/8"	38.1	Z682841210	155,55
3/4"	41.3	Z682841212	129,15
1"	47.6	Z682841616	176,85
1"1/4	54	Z682842020	242,23
1"1/2	63.5	Z682842424	387,72
2"	79.4	Z682843232	559,29

Conexiones una sola pieza Serie BW R12/4SP/4SH

One piece fittings BW Series R12/4SP/4SH
Embouts pré-sertis R12/4SP/4SH Série BW
Raccordi Compatti R12/4SP/4SH Serie BW

Pipe fittings

Pipe fittings II

Adaptors

Welding fittings

Industrial fittings

Accessories

Control components

Flow measuring

Tralle LOK

Hembras giratorias rectas una sola pieza rosca Métrica cono 24° con junta tórica

One piece Metric swivel female 24° seat with o'ring

Femelle pré-sertie Métrique 24° avec o'ring

Femmina compatta Metrica sede 24° con o'ring

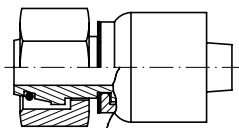

DN	PIPE TUBO	SERIE	THREAD ROSCA	Part n° Referencia	€
1/2"	16	S	M24x1.5	Z68204241608	52,73
3/4"	20	S	M30x2	Z68204302012	81,84
3/4"	25	S	M36x2	Z68204362512	96,70
1"	30	S	M42x2	Z68204423016	119,36
1"1/4	38	S	M52x2	Z68204523820	165,25

Macho una sola pieza Métricos cono 24°

One piece Metric male stud 24° cone

Mâle pré-serti Métrique cone 24°

Maschio compatto Metrico sede 24°

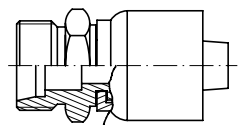

DN	PIPE TUBO	SERIE	THREAD ROSCA	Part n° Referencia	€
1/2"	16	S	M24x1.5	Z68203241608	53,27
3/4"	20	S	M30x2	Z68203302012	84,55
3/4"	25	S	M36x2	Z68203362512	104,12
1"	30	S	M42x2	Z68203423016	124,15
1"1/4	38	S	M52x2	Z68203523820	205,36

Hembras giratorias 90° una sola pieza Métricas cono 24° con junta tórica

One piece Metric swivel female 24° seat with o'ring (90° Elbow)

Coude 90° femelle pré-sertie Métrique 24° avec o'ring

Femmina compatta Metrica 90° sede 24° con o'ring

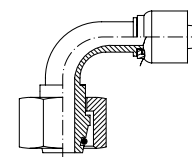

DN	PIPE TUBO	SERIE	THREAD ROSCA	Part n° Referencia	€
1/2"	16	S	M24x1.5	Z68205241608	64,38
3/4"	20	S	M30x2	Z68205302012	101,40
3/4"	25	S	M36x2	Z68205362512	133,24
1"	30	S	M42x2	Z68205423016	168,95
1"1/4	38	S	M52x2	Z68205523820	232,63

Hembras giratorias 45° una sola pieza Métricas cono 24° con junta tórica

One piece Metric swivel female 24° seat with o'ring (45° Elbow)

Coude 45° femelle pré-sertie Métrique 24° avec o'ring

Femmina compatta Metrica 45° sede 24°

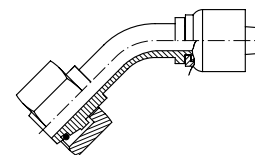

DN	PIPE TUBO	SERIE	THREAD ROSCA	Part n° Referencia	€
1/2"	16	S	M24x1.5	Z68206241608	64,38
3/4"	20	S	M30x2	Z68206302012	101,40
3/4"	25	S	M36x2	Z68206362512	133,24
1"	30	S	M42x2	Z68206423016	168,95
1"1/4	38	S	M52x2	Z68206523820	232,63

Conexiones una sola pieza Serie BW R12/4SP/4SH

One piece fittings BW Series R12/4SP/4SH
Embouts pré-sertis R12/4SP/4SH Série BW
Raccordi Compatti R12/4SP/4SH Serie BW

Hembras giratorias 90° una sola pieza BSP 60° con junta tórica

One piece BSP Swivel female 60° cone with o'ring
(90° Elbow)

Coude 90° femelle pré-sertie BSP 60° avec o'ring

Femmina 90° compatta BSP sede 60° con o'ring

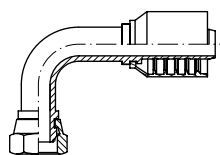

DN	THREAD ROSCA	Part n° Referencia	€
1/2"	1/2" BSP	Z681170808	77,12
5/8"	5/8" BSP	Z681171010	105,77
3/4"	3/4" BSP	Z681171212	94,23
1"	1" BSP	Z681171616	130,39
1"1/4	1"1/4 BSP	Z681172020	200,20
1"1/2	1"1/2 BSP	Z681172424	302,36
2"	2" BSP	Z681173232	510,77

Hembras giratorias 45° una sola pieza BSP 60° C/J

One piece BSP Swivel female 60° cone with o'ring
(45° Elbow)

Coude 45° femelle pré-sertie BSP 60° avec o'ring

Femmina 45° compatta BSP sede 60° con o'ring

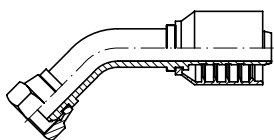

DN	THREAD ROSCA	Part n° Referencia	€
1/2"	1/2" BSP	Z681180808	77,12
5/8"	5/8" BSP	Z681181010	105,77
3/4"	3/4" BSP	Z681181212	94,23
1"	1" BSP	Z681181616	130,39
1"1/4	1"1/4 BSP	Z681182020	200,20
1"1/2	1"1/2 BSP	Z681182424	302,36
2"	2" BSP	Z681183232	510,77

Machos cilíndricos una sola pieza BSP 60°

One piece BSP Male 60° cone

Mâle pré-serti gaz cylindrique BSP 60°

Maschio compatto BSP cilindrico sede 60°

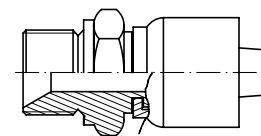

DN	THREAD ROSCA	Part n° Referencia	€
1/2"	1/2" BSP	Z681120808	52,65
5/8"	5/8" BSP	Z681121010	65,63
3/4"	3/4" BSP	Z681121212	76,37
1"	1" BSP	Z681121616	101,06
1"1/4	1"1/4 BSP	Z681122020	167,25
1"1/2	1"1/2 BSP	Z681122424	237,30
2"	2" BSP	Z681123232	419,31

Casquillos para conexiones una sola pieza

Ferrules for one piece fittings

Jupes pour embouts pré-sertis

Boccole per raccordi compatti

Casquillos R1AT/R2AT/1SN/2SN /R16/2SC una sola pieza serie 43

Ferrules R1AT/R2AT/1SN/2SN/R16/2SC for one piece fittings 43 series

Jupes R1AT/R2AT/1SN/2SN/R16/2SC pour embous pré-sertis série 43

Boccole a pressione R1AT/R2AT/1SN/2SN/R16/2SN per raccordi compatti serie 43

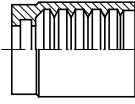

DN	Part n° Referencia	€
1/4"	ZPFC221200400	9,90
5/16"	ZPFC221200500	13,10
3/8"	ZPFC221200600	12,87
1/2"	ZPFC221200800	13,55
5/8"	ZPFC221201000	16,24
3/4"	ZPFC221201200	23,44
1"	ZPFC221201600	39,43
1"1/4	ZPFC221202000	64,19
1"1/2	ZPFC221202400	75,99
2"	ZPFC221203200	110,05

Casquillos 3SP/4SP/R12/4SH serie standard no pelar

Ferrules 3SP/4SP/R12/4SH standard series non skive

Jupes 3SP/4SP/R12/4SH série standard sans dénudage

Boccole a pressione per 3SP/4SP/R12/4SH per Standard Serie senza spellatura

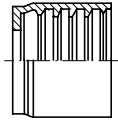

DN	Part n° Referencia	€
3/8"	ZPF222400600	10,42
1/2"	ZPF222400800	12,21
5/8"	ZPF222401000	17,88
3/4"	ZPF222401200	21,60
1"	ZPF222401600	33,68
1" 1/4	ZPF222402000	56,45

Casquillos R7, R8 y elastómero malla metálica una sola pieza

Ferrules R7, R8 and braid of steel wire for one piece fittings

Jupes R7, R8 et elastomère tresse métallique pour embouts pré-sertis

Boccole a pressione R7, R8 per raccordi compatti

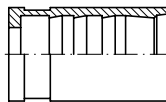

DN	Part n° Referencia	€
3/16"	880120300	7,78
1/4"	880120400	7,65
5/16"	880120500	8,82
3/8"	880120600	9,03
1/2"	880120800	10,06
3/4"	880121200	16,72
1"	880121600	26,90

Casquillos PTFE Liso una sola pieza

Ferrules smooth PTFE for one piece fittings

Jupes PTFE Lisse pour embouts pré-sertis

Boccole a pressione PTFE liscio per raccordi compatti

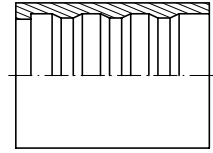

DN	Part n° Referencia	€
1/4"	880400400	6,55
5/16"	880400500	8,26
3/8"	880400600	7,76
1/2"	880400800	8,67
5/8"	880401000	16,36
3/4"	880401200	13,72
1"	880401600	23,50

Casquillos PTFE Corrugado una sola pieza

Ferrules convoluted PTFE for one piece fittings

Jupes PTFE Convoluté pour embouts pré-sertis

Boccole a pressione PTFE corrugato per raccordi compatti

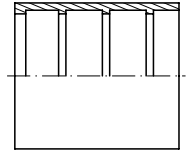

DN	Part n° Referencia	€
1/4"	880410400	7,74
5/16"	880410500	7,00
3/8"	880410600	7,97
1/2"	880410800	10,52
5/8"	880411000	14,25
3/4"	880411200	16,74
1"	880411600	26,42

Casquillos 1SC/1SN/2SC/R6

Ferrules 1SC/1SN/2SC/R6

Jupes 1SC/1SN/2SC/R6

Boccole a pressione per 1SC/1SN/2SC/R6

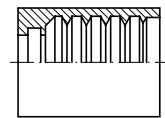

DN	Part n° Referencia	€
1/4"	ZSCC21120400	9,47
5/16"	ZSCC21120500	9,37
3/8"	ZSCC21120600	10,92
1/2"	ZSCC21120800	12,19
5/8"	ZSCC21121000	15,79
3/4"	ZSCC21121200	22,72
1"	ZSCC21121600	31,04

Casquillos R12/4SP/4SH para serie BW

Ferrules R12/4SP/4SH for fittings BW series

Jupes R12/4SP/4SH pour embouts série BW

Boccole a pressione per R12/4SP/4SH per raccordi serie BW

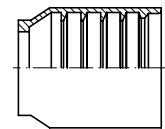

DN	Part n° Referencia	€
1/2"	ZAC680100800	25,11
5/8"	ZAC680101000	27,57
3/4"	ZAC680101200	35,19
1"	ZAC680101600	45,23
1"1/4	ZAC680102000	69,97
1"1/2	ZAC680102400	101,98
2"	ZAC680103200	152,68

Conexiones Reusables

Reusable series
Embouts série récupérable
Serie Recuperabile

Casquillos reusables para manguera R1T no pelar

Reusable ferrules R1T non skive

Jupes récupérables R1T sans dénudage

Boccola recuperabile per R1T senza pelatura

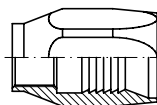

DN	Part n° Referencia	€
1/4"	Z1G-4 R1T INOX	28,34
5/16"	Z1G-5 R1T INOX	32,79
3/8"	Z1G-6 R1T INOX	24,94
1/2"	Z1G-8 R1T INOX	32,83
3/4"	Z1G-12 R1T INOX	38,99
1"	Z1G-16 R1T INOX	70,50

Casquillos reusables para manguera R2AT no pelar

Reusable ferrules R2AT non skive

Jupes récupérables R2AT sans dénudage

Boccola recuperabile per R2AT senza pelatura

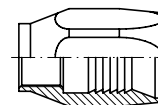

DN	Part n° Referencia	€
1/4"	Z1G-4 R2T INOX	29,13
3/8"	Z1G-6 R2T INOX	23,98
1/2"	Z1G-8 R2T INOX	29,15
5/8"	Z1G-10 R2T INOX	49,02
3/4"	Z1G-12 R2T INOX	52,73
1"	Z1G-16 R2T INOX	76,14

Hembras giratorias rectas reusables rosca BSP cono 60°

Reusable BSP Swivel female 60° cone

Femelle récupérable gaz cylindrique 60°

Femmina diritta BSP sede 60° recuperabile

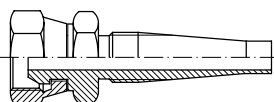

DN	THREAD ROSCA	Part n° Referencia	€
1/4"	1/4" BSP	Z3G-4	33,10
5/16"	3/8" BSP	Z3G-6-5	36,81
3/8"	3/8" BSP	Z3G-6	35,54
3/8"	1/2" BSP	Z3G-8-6	42,95
1/2"	1/2" BSP	Z3G-8	41,26
3/4"	3/4" BSP	Z3G-12	62,76
1"	1" BSP	Z3G-16	107,32
1"1/4"	1"1/4" BSP	Z3G-20	209,10
1"1/2"	1"1/2" BSP	Z3G-24	252,99

Hembras giratorias 90° reusables rosca BSP cono 60°

Reusable BSP 60° cone (90° Elbow)

Coude 90° femelle récupérable gaz cylindrique BSP 60°

Femmina 90° BSP sede 60° recuperabile

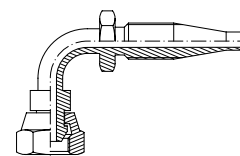

DN	THREAD ROSCA	Part n° Referencia	€
1/4"	1/4" BSP	Z90G-4	58,91
3/8"	3/8" BSP	Z90G-6	62,42
3/8"	1/2" BSP	Z90G-8-6	92,50
1/2"	1/2" BSP	Z90G-8	87,29
3/4"	3/4" BSP	Z90G-12	117,40
1"	1" BSP	Z90G-16	184,82

Machos reusables rosca cilíndrica BSP cono 60°

Reusable BSP Male parallel 60° cone

Mâle récupérable gaz cylindrique BSP 60°

Maschio BSP cilindrico sede 60° recuperabile

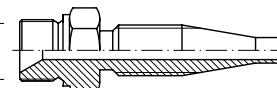

DN	THREAD ROSCA	Part n° Referencia	€
1/4"	1/4" BSP	Z2G-4	33,10
5/16"	3/8" BSP	Z2G-6-5	35,65
3/8"	3/8" BSP	Z2G-6	35,00
3/8"	1/2" BSP	Z2G-8-6	42,58
1/2"	1/2" BSP	Z2G-8	39,50
3/4"	3/4" BSP	Z2G-12	65,10
1"	1" BSP	Z2G-16	84,98

Conexiones Reusables

Reusable series

Embouts série récupérable

Serie Recuperabile

Pipe fittings

Pipe fittings II

Adaptors

Welding fittings

Industrial fittings

Accessories

Control components

Flow measuring

Tralle LOK

Hembras giratorias rectas reusables rosca JIC cono 37°

Reusable JIC 37° straight Swivel female

Femelle droite récupérable JIC 37°

Femmina dirritta JIC sede 37° recuperabile

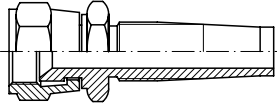

DN	THREAD ROSCA	Part n° Referencia	€
1/4"	7/16" 20h UNF	Z3J-07-04	36,41
3/8"	9/16" 18h UNF	Z3J-09-06	39,09
1/2"	3/4" 16h UNF	Z3J-12-08	45,39
1/2"	7/8" 14h UNF	Z3J-14-08	63,33
5/8"	7/8" 14h UNF	Z3J-14-10	55,07
3/4"	1"1/16 12h UNF	Z3J-17-12	70,42
1"	1"5/16 12h UNF	Z3J-21-16	118,05

Machos reusables rosca JIC cono 37°

Reusable JIC Male 37° cone

Mâle récupérables JIC cône 37°

Maschio JIC 37°

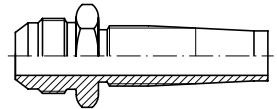

DN	THREAD ROSCA	Part n° Referencia	€
1/4"	7/16" 20h UNF	Z2J-07-04	38,07
3/8"	9/16" 18h UNF	Z2J-09-06	40,25
1/2"	3/4" 16h UNF	Z2J-12-08	47,08
1/2"	7/8" 14h UNF	Z2J-14-08	69,15
5/8"	7/8" 14h UNF	Z2J-14-10	68,56
3/4"	1"1/16 12h UNF	Z2J-17-12	74,87
1"	1" 5/16 12h UNF	Z2J-21-16	124,54

Machos reusables rosca NPT

Reusable NPT Male

Mâle récupérables NPT

Maschio NPT recuperabile

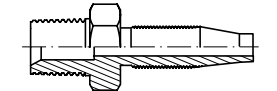

DN	THREAD ROSCA	Part n° Referencia	€
1/4"	1/4" NPT	Z2NPT-04-04	31,45
3/8"	3/8" NPT	Z2NPT-06-06	33,25
1/2"	1/2" NPT	Z2NPT-08-08	37,53
5/8"	5/8" NPT	Z2NPT-10-10	45,60
3/4"	3/4" NPT	Z2NPT-12-12	61,85
1"	1" NPT	Z2NPT-16-16	80,73

Hembras giratorias 90° reusables rosca JIC cono 37°

90° reusable Swivel female thread JIC cone 37°

Femelle pivotante 90° filetage réutilisable cône JIC 37°

90° riutilizzabile Femmina girevole Filetto cono JIC 37°

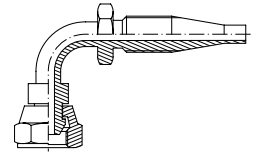

DN	THREAD ROSCA	Part n° Referencia	€
1/4"	7/16" 20h UNF	Z3J90-07-04	*
3/8"	9/16" 18h UNF	Z3J90-09-06	*
1/2"	3/4" 16h UNF	Z3J90-12-08	*
1/2"	7/8" 14h UNF	Z3J90-14-08	*
5/8"	7/8" 14h UNF	Z3J90-14-10	*
3/4"	1"1/16 12h UN	Z3J90-17-12	*
1"	1"5/16 12h UN	Z3J90-21-16	*

Hembras giratorias 45° reusables rosca JIC cono 37°

45° reusable Swivel female thread JIC cone 37°

Femelle pivotante 45° filetage réutilisable cône JIC 37°

45° riutilizzabile Femmina girevole Filetto cono JIC 37°

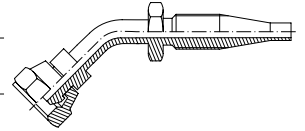

DN	THREAD ROSCA	Part n° Referencia	€
1/4"	7/16" 20h UNF	Z3J45-07-04	*
3/8"	9/16" 18h UNF	Z3J45-09-06	*
1/8"	3/4" 16h UNF	Z3J45-12-08	*
1/2"	7/8" 14h UNF	Z3J45-14-08	*
5/8"	7/8" 14h UNF	Z3J45-14-10	*
3/4"	1"1/16 12h UN	Z3J45-17-12	*
1"	1"5/16 12h UN	Z3J45-21-16	*

Espigas lisas Métricas reusables

Reusable Metric standpipe

Embout lisse récupérable Métrique

Estremità tubolare recuperabile

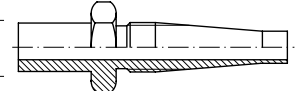

DN	PIPE TUBO	Part n° Referencia	€
1/4"	6	ZE-6-4	30,88
1/4"	8	ZE-8-4	29,38
3/8"	8	ZE-8-6	28,53
1/4"	10	ZE-10-4	29,38
5/16"	10	ZE-10-5	29,79
3/8"	10	ZE-10-6	42,70
5/16"	12	ZE-12-5	29,79
3/8"	12	ZE-12-6	42,70
3/8"	15	ZE-15-6	42,70
1/2"	15	ZE-15-8	41,91
1/2"	16	ZE-16-8	41,89
3/4"	22	ZE-22-12	63,50
3/4"	25	ZE-25-12	88,00
1"	25	ZE-25-16	*
1"	28	ZE-28-16	*
1"	30	ZE-30-16	*

Conexiones Reusables para R5

Reusable series for R5

Embouts série récupérable pour R5

Serie Recuperabile per R5

Hembras giratorias rectas reusables R5 rosca JIC cono 37°

Reusable R5 JIC 37° straight swivel female

Femelle pivotante droite réutilisable R5 JIC filetage 37° cône

Femmina diritta girevole recuperabile per R5 filetto JIC cono 37°

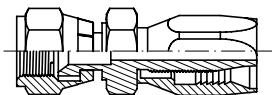

DN	THREAD ROSCA	Part n° Referencia	€
3/16"	7/16" 20 UNF	Z3J-07-04-R5	38,37
1/4"	7/16" 20h UNF	Z3J-07-05-R5	38,78
1/4"	1/2" 20h UNF	Z3J-08-05-R5	40,68
5/16"	9/16" 18h UNF	Z3J-09-06-R5	41,12
13/32"	3/4" 16h UNF	Z3J-12-08-R5	48,44
1/2"	3/4" 16h UNF	Z3J-12-10-R5	60,87
1/2"	7/8"x14 UNF	Z3J-14-10-R5	63,17
5/8"	1" 1/16" 12 UNF	Z3J-17-12-R5	76,69
7/8"	1" 5/16" 12 UNF	Z3J-21-16-R5	120,22
1"1/8"	1" 5/8 12 UNF	Z3J-26-20-R5	280,20
1"3/8"	1" 7/8 12 UNF	Z3J-30-24-R5	315,62
1"13/16"	2" 1/2 12UNF	Z3J-40-32-R5	460,20

Hembras giratorias 90° reusables R5 rosca JIC cono 37°

Reusable R5 JIC 37° swivel female (90° elbow)

Femelle pivotante 90° filetage R5 réutilisable cône JIC 37°

Femmina girevole 90° recuperabile per R5 filetto JIC cono 37°

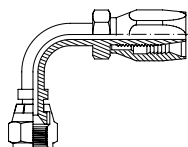

DN	THREAD ROSCA	Part n° Referencia	€
3/16"	7/16" 20 UNF	Z3J90-07-04-R5	*
1/4"	7/16" 20h UNF	Z3J90-07-05-R5	*
1/4"	1/2" 20h UNF	Z3J90-08-05-R5	*
5/16"	9/16" 18h UNF	Z3J90-09-06-R5	*
13/32"	3/4" 16h UNF	Z3J90-12-08-R5	*
1/2"	3/4" 16h UNF	Z3J90-12-10-R5	*
1/2"	7/8" 14 UNF	Z3J90-14-10-R5	*
5/8"	1" 1/16 12 UNF	Z3J90-17-12-R5	*
7/8"	1" 5/16" 12 UNF	Z3J90-21-16-R5	*

Hembras giratorias 45° reusables R5 rosca JIC cono 37°

Reusable R5 JIC 37° swivel female (45° elbow)

Femelle pivotante 45° réutilisable Filetage R5 Cône JIC 37°

Femmina 45° girevole recuperabile per R5 filetto JIC cono 37°

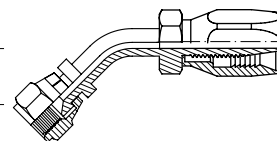

DN	THREAD ROSCA	Part n° Referencia	€
3/16"	7/16" 20 UNF	Z3J45-07-04-R5	*
1/4"	7/16" 20h UNF	Z3J45-07-05-R5	*
1/4"	1/2" 20h UNF	Z3J45-08-05-R5	*
5/16"	9/16" 18h UNF	Z3J45-09-06-R5	*
13/32"	3/4" 16h UNF	Z3J45-12-08-R5	*
1/2"	3/4" 16h UNF	Z3J45-12-10-R5	*
1/2"	7/8" 14 UNF	Z3J45-14-10-R5	*
5/8"	1" 1/16 12 UNF	Z3J45-17-12-R5	*
7/8"	1" 5/16" 12 UNF	Z3J45-21-16-R5	*

Machos reusables R5 rosca NPT

Reusable R5 NPT Male

Mâle récupérables R5 NPT

Maschio R5 NPT recuperabile

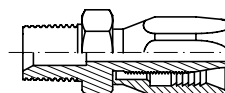

DN	THREAD ROSCA	Part n° Referencia	€
3/16"	1/4" NPT	Z2P-04-04-R5	36,48
1/4"	1/4" NPT	Z2P-04-05-R5	37,93
5/16"	3/8" NPT	Z2P-06-06-R5	38,57
13/32"	1/2" NPT	Z2P-08-08-R5	43,53
1/2"	1/2" NPT	Z2P-08-10-R5	52,90
5/8"	3/4" NPT	Z2P-12-12-R5	71,75
7/8"	1" NPT	Z2P-16-16-R5	93,65
1" 1/8"	1" 1/4 NPT	Z2P-20-20-R5	122,75
1" 3/8"	1" 1/2 NPT	Z2P-24-24-R5	202,12
1" 13/16"	2" NPT	Z2P-32-32-R5	331,38

CONEXIONES REUSABLES R5

REUSABLE R5 FITTINGS



Consulta datos en nuestra ficha técnica | Check our technical sheet for data

Sistemas hidráulicos de **media presión** con fluidos basados en petróleo o agua/glycol, aceites y lubricantes.

Medium pressure hydraulic systems with petroleum or water/glycol based fluids and for fuel and lubricating oils

Conexiones Push-On

Push-On Fittings
Embouts Push-On
Raccordi Serie Push-On

Pipe fittings

Pipe fittings II

Adaptors

Welding fittings

Industrial fittings

Accessories

Control components

Flow measuring

Tralle LOK

Hembras giratorias rectas rosca BSP cono 60°

BSP Swivel female 60° cone

Femelle tournante BSP cono 60°

Femmina diritta BSP sede 60°

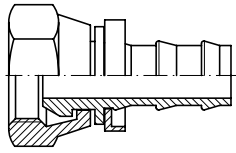

DN	THREAD ROSCA	Part nº Referencia	€
1/4"	1/4" BSP	891000404	16,12
3/8"	3/8" BSP	891000606	16,54
1/2"	1/2" BSP	891000808	19,55
5/8"	5/8" BSP	891001010	31,17
3/4"	3/4" BSP	891001212	26,77
1"	1" BSP	891001616	42,39

Machos rosca cilíndrica BSP cono 60°

BSP Male 60° cone

Mâle fixe BSP cono 60°

Maschio BSP cilindrico sede 60°

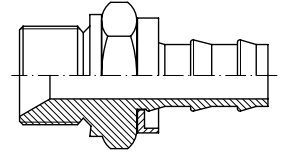

DN	THREAD ROSCA	Part nº Referencia	€
1/4"	1/4" BSP	891120404	17,95
3/8"	3/8" BSP	891120606	16,47
1/2"	1/2" BSP	891120808	23,74
3/4"	1/2" BSP	891120812	33,77
5/8"	5/8" BSP	891121010	32,13
3/4"	3/4" BSP	891121212	44,43
1"	1" BSP	891121616	53,06

Hembras giratorias rectas JIC 37°

JIC 37° Swivel female

Femelle tournante JIC 37°

Femmina diritta JIC sede 37°

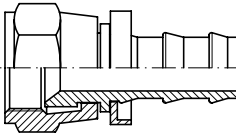

DN	THREAD ROSCA	Part nº Referencia	€
1/4"	7/16" 20h UNF	891420704	14,23
3/8"	9/16" 18h UNF	891420906	17,59
1/2"	3/4" 16h UNF	891421208	19,38
5/8"	7/8" 14h UNF	891421410	23,55
3/4"	1"1/16 12h UN	891421712	36,77
1"	1"5/16 12h UN	891422116	45,54

Machos rosca JIC cono 37°

JIC 37° Male

Mâle fixe JIC 37°

Maschio JIC sede 37°

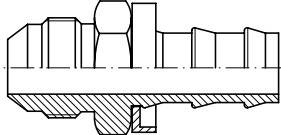

DN	THREAD ROSCA	Part nº Referencia	€
1/4"	7/16" 20h UNF	891400704	17,45
3/8"	9/16" 18h UNF	891400906	19,67
1/2"	3/4" 16h UNF	891401208	22,95
5/8"	7/8" 14h UNF	891401410	33,87
3/4"	1"1/16 12h UN	891401712	39,28
1"	1"5/16 12h UN	891402116	49,60

Machos rosca cónica NPT

NPT Male pipe straight

Mâle gaz conique NPT (BRIGGS)

Maschio NPT conico

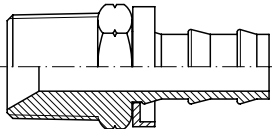

DN	THREAD ROSCA	Part nº Referencia	€
1/4"	1/4" NPT	891610404	14,86
3/8"	3/8" NPT	891610606	20,28
1/2"	1/2" NPT	891610808	23,60
3/4"	3/4" NPT	891611212	32,42
1"	1" NPT	891611616	40,04

Hembra giratoria recta Métrica cono 24°

Metric female swivel with o'ring 24° cone

Femelle Métrique avec o'ring cône 24°

Femmina Metrica sede 24° con o'ring

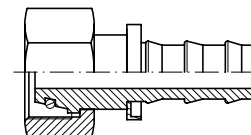

DN	PIPE TUBO	SERIE	THREAD ROSCA	Part nº Referencia	€
1/4"	8	L	M14x1.5	89804140804	17,68
1/4"	10	L	M16x1.5	89804161004	17,46
3/8"	12	L	M18x1.5	89804181206	18,65
1/2"	15	L	M22x1.5	89804221508	21,73
3/4"	22	L	M30x2	89804302212	33,36

Machos rosca métrica cono 24°

Metric stud 24° cone

Mâle Métrique cône 24°

Maschio Metrico sede 24°

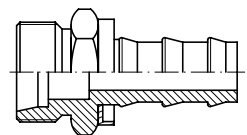

DN	PIPE TUBO	SERIE	THREAD ROSCA	Part nº Referencia	€
1/4"	8	L	M14x1.5	89203140804	18,13
1/4"	10	L	M16x1.5	89203161004	17,97
3/8"	12	L	M18x1.5	89203181206	18,87
1/2"	15	L	M22x1.5	89203221508	22,69
3/4"	22	L	M30x2	89203302212	33,73

Conexiones Alta Presión (700 bar)

High pressure 700 bar fittings

Embouts haute pression 700 bar

Raccordi Altissima pressione (700 bar)

Casquillos para alta presión (700bar)

Ferrules for thermoplastic hose 700 bar

Jupes à sertir thermoplastique 700 bar

Boccole per tubo termoplastico 700 bar

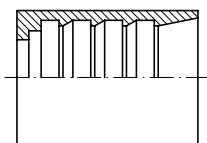

DN	Part nº Referencia	€
1/4"	Z710120400	33,56
3/8"	Z710120600	34,89
1/2"	Z710120800	36,99

Hembra giratoria BSP cono 60° (700bar)

BSP Swivel female 60° cone 700 bar

Embout 700 bar femelle tournante gaz cyl BSP 60°

Femmina diritta BSP sede 60° 700 bar

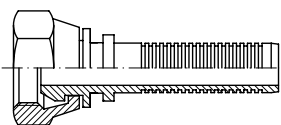

DN	THREAD ROSCA	Part nº Referencia	€
1/4"	1/4" BSP	Z741000404	57,93
3/8"	3/8" BSP	Z741000606	60,95
1/2"	1/2" BSP	Z741000808	63,40

Macho BSP cono 60° (700bar)

BSP Male parallel 60° cone 700 bar

Embout 700 bar mâle fixe gaz cyl BSP 60°

Maschio cilindrico BSP sede 60° 700 bar

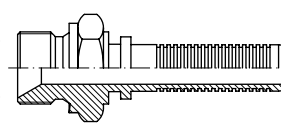

DN	THREAD ROSCA	Part nº Referencia	€
1/4"	1/4" BSP	Z741120404	66,81
3/8"	3/8" BSP	Z741120606	69,00
1/2"	1/2" BSP	Z741120808	74,76

Hembra giratoria NPSM cono 60° (700bar)

NPSM Swivel female 60° cone 700 bar

Embout 700 bar femelle tournante NPSM 60°

Femmina diritta NPSM sede 60° 700 bar

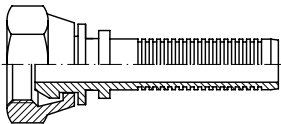

DN	THREAD ROSCA	Part nº Referencia	€
1/4"	1/4" 18h NPSM	Z742610404	57,93
3/8"	3/8" 18h NPSM	Z742610606	64,16
1/2"	1/2" 14h NPSM	Z742610808	66,74

Macho NPT (700bar)

NPT Male pipe straight 700 bar

Embout 700 bar mâle fixe gaz conique NPT

Maschio conico NPT 700 bar

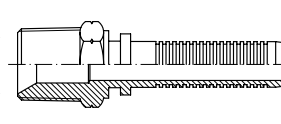

DN	THREAD ROSCA	Part nº Referencia	€
1/4"	1/4" NPT	Z741610404	66,81
1/4"	3/8" NPT	Z741610604	72,45
3/8"	3/8" NPT	Z741610606	69,00
1/2"	1/2" NPT	Z741610808	74,76

Hembra giratoria JIC 37° (700bar)

JIC 37° Swivel female 700 bar

Embout 700 bar femelle tournante droit JIC 37°

Femmina JIC 37° 700 bar

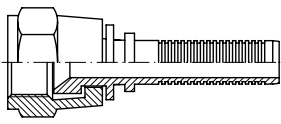

DN	THREAD ROSCA	Part nº Referencia	€
1/4"	7/16" 20h UNF	Z741420704	63,73
1/4"	9/16" 18h UNF	Z741420904	71,21
3/8"	9/16" 18h UNF	Z741420906	67,05
1/2"	3/4" 16h UNF	Z741421208	69,75

Macho JIC 37° (700bar)

JIC 37° Male thread 700 bar

Embout 700 bar mâle fixe JIC 37°

Maschio JIC 37° 700 bar

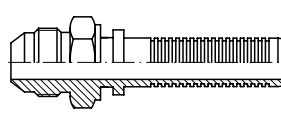

DN	THREAD ROSCA	Part nº Referencia	€
1/4"	7/16" 20h UNF	Z741400704	77,36
3/8"	9/16" 18h UNF	Z741400906	79,89
1/2"	3/4" 16h UNF	Z741401208	86,56

Conexiones Alta Presión (700 bar)

High pressure 700 bar fittings

Embout haute pression 700 bar

Raccordi Altissima pressione (700 bar)

Hembra giratoria Métrica 24° (700bar)

Metric Swivel female 24° cone 700 bar

Embout 700 bar femelle tournante droit
Métrique cone 24°

Femmina diritta Metrica sede 24° 700 bar

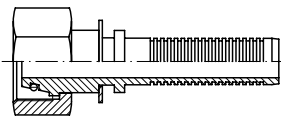

DN	PIPE TUBO	SERIE	THREAD ROSCA	Part nº Referencia	€
1/4"	8	S	M16x1.5	Z74804160804	83,37
3/8"	12	S	M20x1.5	Z74804201206	85,21
1/2"	16	S	M24x1.5	Z74804241608	86,03

Macho Métrico 24° (700bar)

Metric Male 24° cone 700 bar

Embout 700 bar mâle fixe Métrique cone 24°

Maschio cilindrico Metrico sede 24° 700 bar

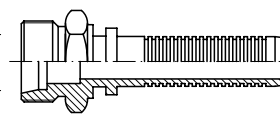

DN	PIPE TUBO	SERIE	THREAD ROSCA	Part nº Referencia	€
1/4"	8	S	M16x1.5	Z74203160804	89,32
3/8"	12	S	M20x1.5	Z74203201206	99,85
1/2"	16	S	M24x1.5	Z74203241608	111,38

Pipe fittings

Pipe fittings II

Adaptors

Welding fittings

Industrial fittings

Accessories

Control components

Flow measuring

Tridle LOK

Conducción rígida

Pipe fittings

Raccord tube rigide

Raccordi ad anello

Tubo TrΔle métrico

TrΔle metric pipe

Tube rigide TrΔle métrique

Tubo rigido TrΔle metrico

91

Racores DIN 2353

DIN 2353 Pipe fittings

Raccords à bague DIN 2353

Raccordi DIN 2353

92

Racores JIC 37°

Flare fittings JIC 37°

Adapteurs JIC 37°

Raccordi JIC 37°

112

2

Racores DIN 2353

DIN 2353 Pipe fittings
Raccords à bague DIN 2353
Raccordi DIN 2353

Instrucciones de montaje del racor DIN 2353 sobre el tubo rígido (se recomienda el uso de herramientas de premontaje)

Assembly of the pipe fittings DIN 2353 in the rigid pipe (It is recommended to use pre-assembly tools)

Instructions de montage du raccord DIN 2353 sur le tube rigide (Nous recommandons l'utilisation d'outils)

Assemblaggio del raccordo ad anello DIN 2353 nel tubo rigido (è si consiglia l'uso degli utensili di premontaggio)

A. Preparación del tubo

Preparation of the tube

Préparation du tube

Preparazione del tubo

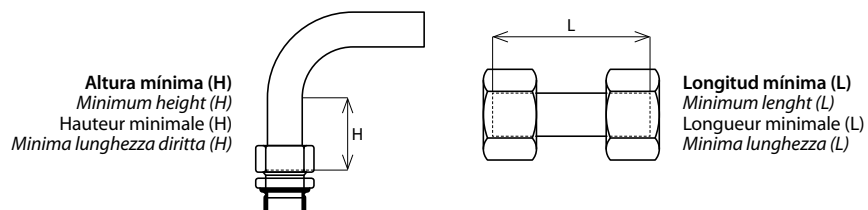

	Serie / Series / Série / Serie		
	LL	L	S
Ø exterior Ø outer Ø extérieur Ø esterno	4-5-6-8	6-8-10-12-15-18-22-28-35-42	6-8-10-12-14-16-20-25-30-38
H mínimo H minimum H minimum H minimo	24-25-25-26	31-31-33-33-36-38-42-42-48-48	35-35-37-37-43-43-50-54-58-65
L mínimo L minimum L minimum L minimo	30-32-32-33	39-39-42-42-45-48-53-53-60-60	44-44-47-47-54-54-63-68-73-82

Cortar el tubo a escuadra y eliminar rebabas.
Rectangularly saw off the pipe and remove all burrs.
Couper le tube à angle droit et entever les bavures.
Tagliare il tubo ad angolo retto ed eliminare i residui metallici.

B. Lubricar adecuadamente

Lubricate properly

Lubrifier convenablement

Lubrificare convenientemente



C. Montaje

Assembly

Montage

Montaggio

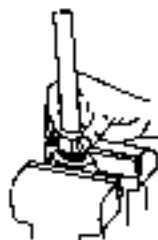

D. Apriete

Blocking

Blockage

Bloccaggio

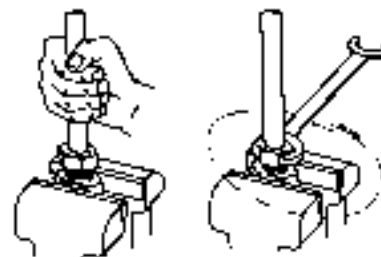

E. Control

Control

Control

Controllo

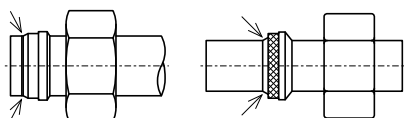

F. Montaje final

Final assembly

Montage final

Montaggio finale

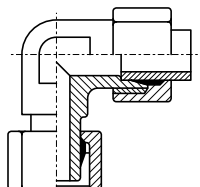

G. Montajes posteriores

Later assemblies

Montages postérieurs

Montaggio successivo



Tubo TrΔle métrico

TrΔle metric pipe
 Tube rigide TrΔle métrique
 Tubo rigido TrΔle metrico

■ Métrico /Metric /Métrique /Metrico



ZTH0



ZTH0...-3

Racores DIN 2353

DIN 2353 Pipe fittings
Raccords à bague DIN 2353
Raccordi DIN 2353

Tuercas y anillos / Nuts and cutting rings / Écrous et bagues / Dadi e anelli | 92

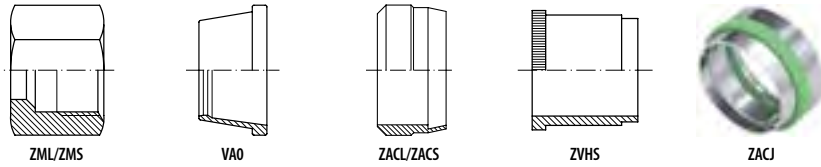

Uniones tubo-tubo / Straight couplings / Raccords union double / Raccordi intermedi | 94

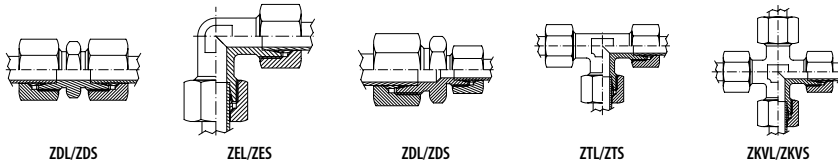

Uniones rectas tubo-rosca / Straight male stud couplings / Raccords union simple mâle / Raccordi di estremità diritti | 96

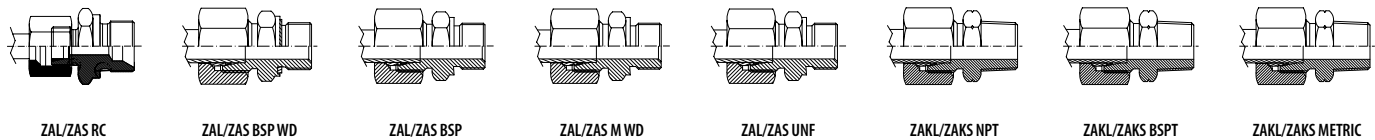

Codos tubo-rosca / Male stud elbows / Raccords coude mâle gaz / Raccordi di estremità a 90° | 99

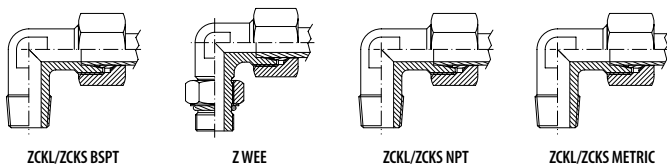

TES rosca central / Male stud branch / Raccords Té mâle central / Raccordi di estremità a T | 100

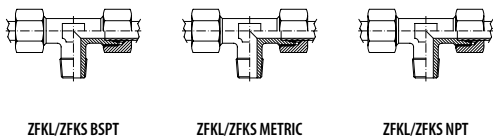

TES rosca lateral / Male stud barrel / Raccords Té mâle latéral / Raccordi di estremità a L | 100

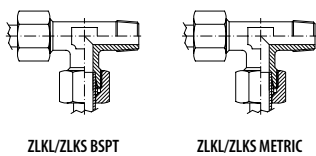

Uniones Métricas / Metric unions / Raccords union Métrique / Raccordi Metrici | 101

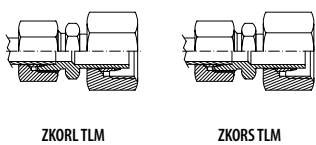

Reducciones roscadas / Reductions / Raccords de réduction / Raccordi di riduzione filettati | 102

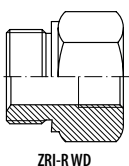

Racores DIN 2353

DIN 2353 Pipe fittings

Raccords à bague DIN 2353

Raccordi DIN 2353

- Racores regulables / Adjustable stud couplings / Raccords réglables / Raccordi orientabili

| 103

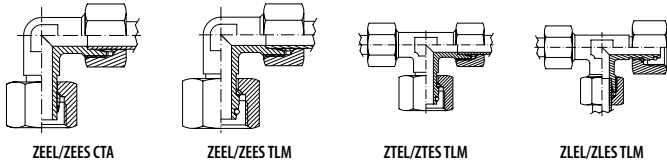

ZEEL/ZEES CTA

ZEEL/ZEES TLM

ZTEL/ZTES TLM

ZLEL/ZLES TLM

- Tube roscado (hembra giratoria) / Adjustable straight stud / Raccords tube fileté / Raccordi di estremità per combinazioni

| 104

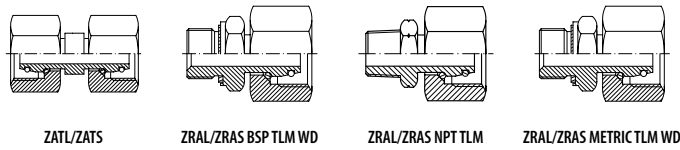

ZATL/ZATS

ZRAL/ZRAS BSP TLM WD

ZRAL/ZRAS NPT TLM

ZRAL/ZRAS METRIC TLM WD

- Soldables / Welding fittings / Raccords à souder / Raccordi a saldare

| 105

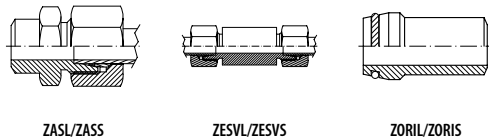

ZASL/ZASS

ZESVL/ZESVS

ZORIL/ZORIS

- Pasatabiques / Bulkhead / Raccords passe cloison / Raccordi passaparete

| 106

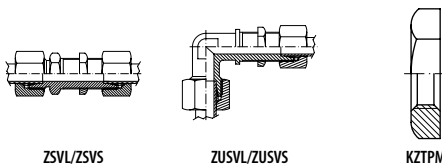

ZSVL/ZSVS

ZUSVL/ZUSVS

KZTPM

- Racor recto hembra / Straight female coupling / Raccords droits femelle / Raccordi diritti con estremità femmina

| 107

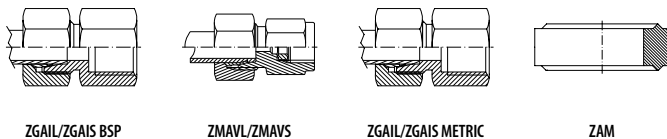

ZGAIL/ZGAIS BSP

ZMAVL/ZMAVS

ZGAIL/ZGAIS METRIC

ZAM

- Orientables / Banjos / Raccords orientables / Raccordi orientabili ad occhio

| 108

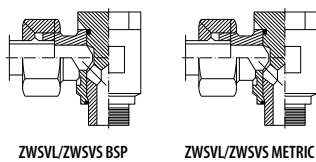

ZWSVL/ZWSVS BSP

ZWSVL/ZWSVS METRIC

- Tapones / Plugs / Raccords bouchon métrique / Tappi

| 109

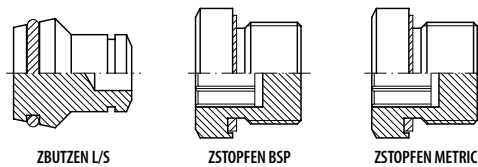

ZBUTZEN L/S

ZSTOPFEN BSP

ZSTOPFEN METRIC

- Juntas / O-rings & captive seals / Joints / Guarnizioni

| 109



JVT

JVBS/PJVM

Racores DIN 2353

DIN 2353 Pipe fittings
Raccords à bague DIN 2353
Raccordi DIN 2353

- Accesorios para montaje / Accessories for the assembly / Accessoires pour le montage / Accessori per assemblaggio | 110

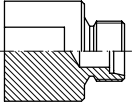

ZVOM0



Grasa

- Válvulas antirretorno / Valves / Valves clapet antiretour / Valvole di ritegno | 111



ZRHVL/ZRHVS

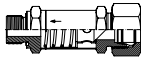

ZRHZL/ZRHZS

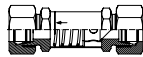

ZRHDL/ZRHDS

Racores JIC 37°

Flare fittings JIC 37°
Adaptateurs JIC 37°
Raccordi JIC 37°

- Tuercas, ferulas y tapones JIC 37° / JIC 37° Nuts, sleeves and plugs / Écrous, ferrules et bouchons JIC 37° / Dadi, bussole e tappi JIC 37° | 112

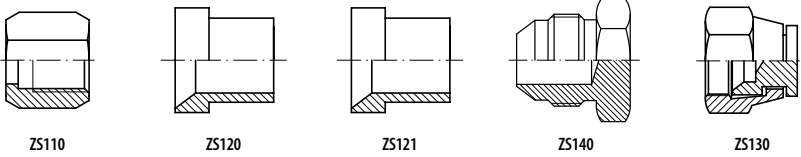

ZS110

ZS120

ZS121

ZS140

ZS130

- Uniones rectas JIC 37° / JIC 37° Straight unions / Union droite JIC 37° / Adattatori diritti JIC 37° | 113

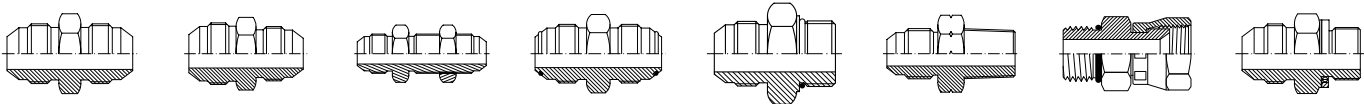

ZS260

ZS260

ZS250

ZS260_OR

ZS240

ZS200

ZS380

ZS230

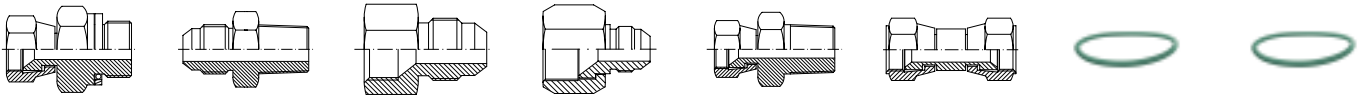

ZS180

ZS210

ZS295

ZS290

ZS185

ZS730

JVMET

JVUNF



JVBSP

JTVIC

- Codos 90° JIC 37° / JIC 37° 90° Elbows / Coudes 90° JIC 37° / Adattatori a 90° JIC 37° | 117

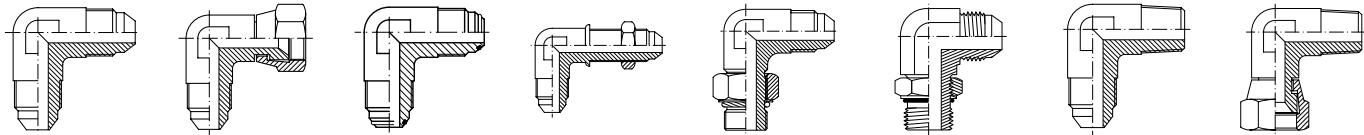

ZS500

ZS675

ZS500_OR

ZS650

ZS570

ZS575

ZS550

ZS595



ZS525

- Codos 45 JIC 37° / JIC 37° 45° Elbows / Coudes 45° JIC 37° / Adattatori a 45° JIC 37° | 119

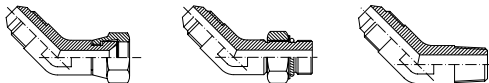

ZS690

ZS775

ZS725

- Tes JIC 37° / JIC 37° Tees / Tés JIC 37° / Adattatori a T JIC 37° | 120

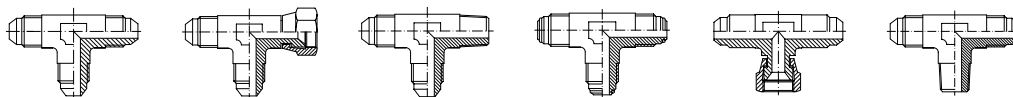

ZS505

ZS680

ZS630

ZS505_OR

ZS685

ZS625

Tubo TrΔle métrico

TrΔle metric pipe
Tube rigide TrΔle métrique
Tubo rigido TrΔle metrico

Crimping fittings for hoses

Pipe fittings

Pipe fittings II

Adaptors

Welding fittings

Industrial fittings

Accessories

Control components

Flow measuring

TrΔle LOK

Tubo rígido - 6 mts

Rigid pipe - 6 mts

Tube rigide - 6 mts

Tubo rigido - 6 mts



Ø OUTER Ø EXT.	Ø INNER Ø INT.	WP (bar) PRESIÓN TRABAJO (bar)	KG/M	Thickness (mm) Espesor (mm)	Part nº Referencia	€
4	2	735	0,075	1	ZTH0040100	4,32
6	4	490	0,125	1	ZTH0060100	6,55
8	6	368	0,175	1	ZTH0080100	7,07
10	7	441	0,318	1,5	ZTH0100150	12,38
12	10	245	0,275	1	ZTH0120100	10,93
12	9	368	0,393	1,5	ZTH0120150	14,28
14	10	420	0,600	2	ZTH0140200	21,42
15	12	294	0,506	1,5	ZTH0150150	18,36
16	12	368	0,700	2	ZTH0160200	25,04
18	15	245	0,618	1,5	ZTH0180150	21,86
18	14	327	0,800	2	ZTH0180200	28,70
20	14	441	1,275	3	ZTH0200300	43,14
22	18	267	1,000	2	ZTH0220200	36,07
25	19	353	1,650	3	ZTH0250300	55,33
28	24	210	1,302	2	ZTH0280200	43,93
30	24	294	2,028	3	ZTH0300300	66,62
35	31	168	1,653	2	ZTH0350200	53,23
38	30	309	3,355	4	ZTH0380400	106,31
42	36	210	2,930	3	ZTH0420300	89,03

Precio por metro. / Price per meter. / Les prix sont par mètre. / I prezzi si intendono al metro

Tubo rígido - 3 mts

Rigid pipe - 3 mts

Tube rigide - 3 mts

Tubo rigido - 3 mts



Ø OUTER Ø EXT.	Ø INNER Ø INT.	WP (bar) PRESIÓN TRABAJO (bar)	KG/M	Thickness (mm) Espesor (mm)	Part nº Referencia	€
4	2	735	0,075	1	ZTH0040100-3	4,63
6	4	490	0,125	1	ZTH0060100-3	6,95
8	6	368	0,175	1	ZTH0080100-3	7,51
10	7	441	0,318	1,5	ZTH0100150-3	13,13
12	10	245	0,275	1	ZTH0120100-3	12,30
12	9	368	0,393	1,5	ZTH0120150-3	15,15
14	10	420	0,600	2	ZTH0140200-3	22,72
15	12	294	0,506	1,5	ZTH0150150-3	19,47
16	12	368	0,700	2	ZTH0160200-3	26,56
18	15	245	0,618	1,5	ZTH0180150-3	23,19
18	14	327	0,800	2	ZTH0180200-3	30,45
20	14	441	1,275	3	ZTH0200300-3	45,77
22	18	267	1,000	2	ZTH0220200-3	38,27
25	19	353	1,650	3	ZTH0250300-3	58,69
28	24	210	1,302	2	ZTH0280200-3	46,60
30	24	294	2,028	3	ZTH0300300-3	70,67
35	31	168	1,653	2	ZTH0350200-3	56,47
38	30	309	3,355	4	ZTH0380400-3	112,78
42	36	210	2,930	3	ZTH0420300-3	94,44

Precio por metro. / Price per meter. / Les prix sont par mètre. / I prezzi si intendono al metro

TUBO SCHEDULE PIPE

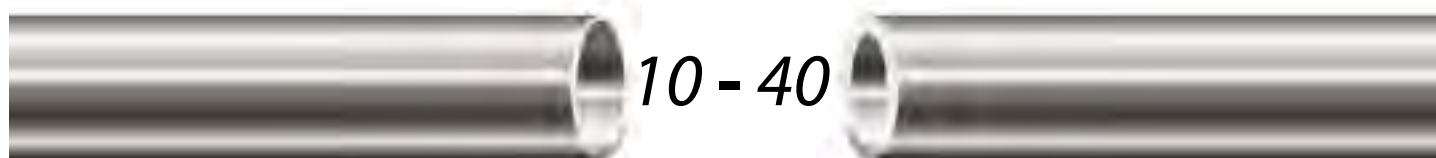

PÁGINA | PAGE
128

Consulta en nuestra ficha técnica datos | Check our technical sheet for data

Racores DIN 2353

DIN 2353 Pipe fittings
Raccords à bague DIN 2353
Raccordi DIN 2353

Tuercas Métricas DIN 3870

Nuts DIN 3870

Écrou DIN 3870

Dado DIN 3870

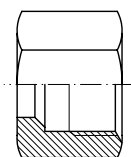

PIPE TUBO	SERIE	THREAD ROSCA	Part nº Referencia	€
4	LL	M8X1	Z MLL 4	2,71
6	LL	M10X1	Z MLL 6	2,71
8	LL	M12X1	Z MLL 8	3,16
6	L	M12X1.5	Z ML 6	2,05
8	L	M14X1.5	Z ML 8	2,54
10	L	M16X1.5	Z ML 10	2,92
12	L	M18X1.5	Z ML 12	3,51
15	L	M22X1.5	Z ML 15	5,08
18	L	M26X1.5	Z ML 18	7,89
22	L	M30X2	Z ML 22	10,25
28	L	M36X2	Z ML 28	21,09
35	L	M45X2	Z ML 35	32,99
42	L	M52X2	Z ML 42	37,71
6	S	M14X1.5	Z MS 6	2,76
8	S	M16X1.5	Z MS 8	3,11
10	S	M18X1.5	Z MS 10	3,89
12	S	M20X1.5	Z MS 12	4,32
14	S	M22X1.5	Z MS 14	7,03
16	S	M24X1.5	Z MS 16	7,81
20	S	M30X2	Z MS 20	11,90
25	S	M36X2	Z MS 25	28,10
30	S	M42X2	Z MS 30	34,10
38	S	M52X2	Z MS 38	53,50

Anillo FKM anti-fuga

FKM ring for leaking prevent

Joint FKM anti-fuite

Anello FKM anti-fuga

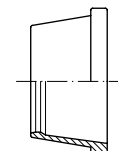

PIPE TUBO	SERIE	Part nº Referencia	€
6	L/S	VA006L	*
8	L/S	VA008L	*
10	L/S	VA010L	*
12	L/S	VA012L	*
15	L	VA015L	*
18	L	VA018L	*
22	L	VA022L	*
28	L	VA028L	*
35	L	VA035L	*
42	L	VA042L	*
14	S	VA014S	*
16	S	VA016S	*
20	S	VA020S	*
25	S	VA025S	*
30	S	VA030S	*
38	S	VA038S	*

*Hasta fin de existencias. Ver precios en Tarifa Conducciones Hidráulicas y Neumáticas / *Until end of stock. See prices in Hydraulic and Pneumatic Connectors' Catalogue / *Jusqu'à la fin du stock. Voir les prix dans le Catalogue Connectique Hydraulique et Pneumatique / *Fino ad esaurimento scorta. Vedere prezzi nel listino Conduzioni Idrauliche e Pneumatiche

Anillos de corte DIN 3861

Cutting rings DIN 3861

Bague DIN 3861

Anello DIN 3861



PIPE TUBO	SERIE	Part nº Referencia	€
4	LL	Z ACLL 4	1,97
6	LL	Z ACLL 6	1,89
8	LL	Z ACLL 8	2,11
6	L/S	Z ACL 6	1,97
8	L/S	Z ACL 8	2,03
10	L/S	Z ACL 10	2,60
12	L/S	Z ACL 12	2,70
15	L	Z ACL 15	2,97
18	L	Z ACL 18	3,24
22	L	Z ACL 22	4,33
28	L	Z ACL 28	6,49
35	L	Z ACL 35	9,92
42	L	Z ACL 42	11,59
14	S	Z ACS 14	3,39
16	S	Z ACS 16	3,68
20	S	Z ACS 20	4,33
25	S	Z ACS 25	6,49
30	S	Z ACS 30	9,73
38	S	Z ACS 38	10,48

Anillo de refuerzo

Reinforced ring

Bague de renforcement

Anello di rinforzo

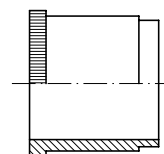

PIPE TUBO	Part nº Referencia	€
4	Z VHS 4	*
5	Z VHS 5	*
6	Z VHS 6	*
7	Z VHS 7	*
8	Z VHS 8	*
9	Z VHS 9	*
10	Z VHS 10	*
11	Z VHS 11	*
12	Z VHS 12	*
13	Z VHS 13	*
14	Z VHS 14	*
15	Z VHS 15	*
16	Z VHS 16	*
17	Z VHS 17	*
18	Z VHS 18	*
19	Z VHS 19	*
20	Z VHS 20	*
22	Z VHS 22	*
24	Z VHS 24	*
25	Z VHS 25	*
31	Z VHS 31	*
33	Z VHS 33	*
38	Z VHS 38	*

Racores DIN 2353

DIN 2353 Pipe fittings
Raccords à bague DIN 2353
Raccordi DIN 2353

Anillos de corte con junta

Cutting ring with joint

Bague avec joint

Anello da taglio con guarnizione



PIPE TUBO	SERIE	Part nº Referencia	€
6	L	Z ACJL 6	3,65
8	L	Z ACJL 8	3,73
10	L	Z ACJL 10	4,21
12	L	Z ACJL 12	4,75
15	L	Z ACJL 15	5,96
18	L	Z ACJL 18	7,46
22	L	Z ACJL 22	8,51
28	L	Z ACJL 28	12,20
35	L	Z ACJL 35	18,06
42	L	Z ACJL 42	22,59
6	S	Z ACJS 6	3,72
8	S	Z ACJS 8	3,76
10	S	Z ACJS 10	4,23
12	S	Z ACJS 12	4,82
14	S	Z ACJS 14	5,86
16	S	Z ACJS 16	6,75
20	S	Z ACJS 20	8,92
25	S	Z ACJS 25	11,98
30	S	Z ACJS 30	15,71
38	S	Z ACJS 38	22,67

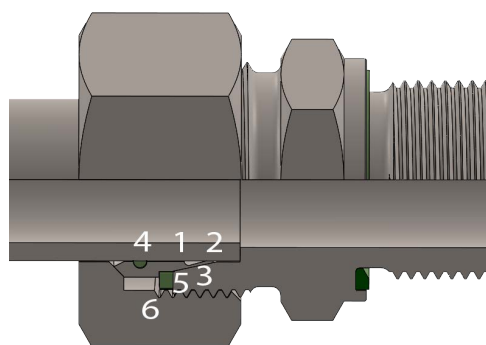

- Asegura una completa estanqueidad con el anillo de corte con junta
- To ensure the right tightening with our cutting ring with joint



Consulta en nuestra ficha técnica datos | Check our technical sheet for data

Racores DIN 2353

DIN 2353 Pipe fittings
Raccords à bague DIN 2353
Raccordi DIN 2353

Racor unión recta tubo - tubo

Straight coupling

Raccord union double

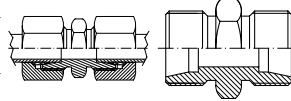

Raccordo intermedio diritto

PIPE TUBO	SERIE	Part nº Referencia	€	Part Nº STA Referencia STA	€
4	LL	Z DLL 4	24,13		*
6	LL	Z DLL 6	21,15		*
8	LL	Z DLL 8	20,42		*
6	L	Z DL 6	13,62	Z STA DL 6	5,94
8	L	Z DL 8	13,64	Z STA DL 8	7,56
10	L	Z DL 10	16,23	Z STA DL 10	8,72
12	L	Z DL 12	18,17	Z STA DL 12	8,88
15	L	Z DL 15	25,83	Z STA DL 15	12,55
18	L	Z DL 18	31,42	Z STA DL 18	14,18
22	L	Z DL 22	40,02	Z STA DL 22	20,14
28	L	Z DL 28	73,39	Z STA DL 28	36,79
35	L	Z DL 35	101,68	Z STA DL 35	49,26
42	L	Z DL 42	150,16	Z STA DL 42	73,36
6	S	Z DS 6	18,18	Z STA DS 6	9,79
8	S	Z DS 8	19,74	Z STA DS 8	8,96
10	S	Z DS 10	23,76	Z STA DS 10	12,94
12	S	Z DS 12	25,30	Z STA DS 12	15,89
14	S	Z DS 14	33,18	Z STA DS 14	18,75
16	S	Z DS 16	30,96	Z STA DS 16	15,24
20	S	Z DS 20	53,26	Z STA DS 20	25,02
25	S	Z DS 25	84,22	Z STA DS 25	40,12
30	S	Z DS 30	113,36	Z STA DS 30	51,59
38	S	Z DS 38	163,93	Z STA DS 38	73,47

Racor unión en codo tubo - tubo

Equal elbow coupling

Raccord coude égal

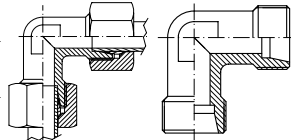

Raccordo intermedio a 90°

PIPE TUBO	SERIE	Part nº Referencia	€	Part Nº STA Referencia STA	€
4	LL	Z ELL 4	35,96		*
6	LL	Z ELL 6	31,95		*
8	LL	Z ELL 8	34,64		*
6	L	Z EL 6	23,29	Z STA EL 6	16,57
8	L	Z EL 8	21,50	Z STA EL 8	17,46
10	L	Z EL 10	24,48	Z STA EL 10	19,43
12	L	Z EL 12	29,83	Z STA EL 12	22,10
15	L	Z EL 15	41,46	Z STA EL 15	27,83
18	L	Z EL 18	56,80	Z STA EL 18	40,12
22	L	Z EL 22	83,14	Z STA EL 22	59,57
28	L	Z EL 28	125,77	Z STA EL 28	83,93
35	L	Z EL 35	194,58	Z STA EL 35	137,85
42	L	Z EL 42	265,44	Z STA EL 42	207,01
6	S	Z ES 6	23,67	Z STA ES 6	19,77
8	S	Z ES 8	27,70	Z STA ES 8	20,97
10	S	Z ES 10	31,69	Z STA ES 10	21,88
12	S	Z ES 12	39,82	Z STA ES 12	29,32
14	S	Z ES 14	49,33	Z STA ES 14	36,09
16	S	Z ES 16	55,79	Z STA ES 16	38,28
20	S	Z ES 20	84,35	Z STA ES 20	59,11
25	S	Z ES 25	131,98	Z STA ES 25	85,62
30	S	Z ES 30	186,69	Z STA ES 30	129,25
38	S	Z ES 38	275,78	Z STA ES 38	186,86

Racor unión recta en reducción tubo - tubo

Straight reducing coupling

Raccord union double en réduction

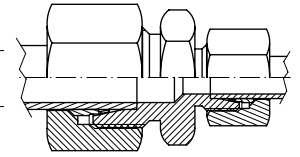

Raccordo di riduzione

PIPE TUBO	SERIE	Part nº Referencia	€	Part Nº STA Referencia STA	€
8	6	L Z DL 8-6	19,31	Z STA DL 8-6	10,26
10	6	L Z DL 10-6	20,36	Z STA DL 10-6	10,37
10	8	L Z DL 10-8	19,47	Z STA DL 10-8	9,05
12	6	L Z DL 12-6	21,93	Z STA DL 12-6	11,25
12	8	L Z DL 12-8	23,66	Z STA DL 12-8	12,36
12	10	L Z DL 12-10	22,06	Z STA DL 12-10	9,87
15	6	L Z DL 15-6	33,65	Z STA DL 15-6	21,13
15	8	L Z DL 15-8	37,12	Z STA DL 15-8	24,04
15	10	L Z DL 15-10	28,90	Z STA DL 15-10	14,87
15	12	L Z DL 15-12	27,69	Z STA DL 15-12	13,72
18	8	L Z DL 18-8	34,75	Z STA DL 18-8	19,10
18	10	L Z DL 18-10	37,00	Z STA DL 18-10	19,90
18	12	L Z DL 18-12	37,56	Z STA DL 18-12	19,77
18	15	L Z DL 18-15	39,27	Z STA DL 18-15	22,56
22	12	L Z DL 22-12	49,94	Z STA DL 22-12	28,69
22	15	L Z DL 22-15	48,43	Z STA DL 22-15	25,34
22	18	L Z DL 22-18	52,30	Z STA DL 22-18	26,18
28	22	L Z DL 28-22	89,44	Z STA DL 28-22	42,56
35	22	L Z DL 35-22	93,43	Z STA DL 35-22	39,03
35	28	L Z DL 35-28	124,47	Z STA DL 35-28	53,52
42	28	L Z DL 42-28	158,37	Z STA DL 42-28	81,74
42	35	L Z DL 42-35	155,13	Z STA DL 42-35	67,12
8	6	S Z DS 8-6	27,24	Z STA DS 8-6	17,39
10	6	S Z DS 10-6	26,77	Z STA DS 10-6	15,53
10	8	S Z DS 10-8	29,63	Z STA DS 10-8	17,46
12	6	S Z DS 12-6	32,00	Z STA DS 12-6	20,33
12	8	S Z DS 12-8	29,66	Z STA DS 12-8	17,04
12	10	S Z DS 12-10	32,01	Z STA DS 12-10	16,29
14	10	S Z DS 14-10	37,85	Z STA DS 14-10	18,40
16	10	S Z DS 16-10	42,43	Z STA DS 16-10	23,99
16	12	S Z DS 16-12	40,00	Z STA DS 16-12	18,97
16	14	S Z DS 16-14	46,57	Z STA DS 16-14	21,64
20	12	S Z DS 20-12	58,02	Z STA DS 20-12	38,37
20	14	S Z DS 20-14	64,63	Z STA DS 20-14	38,38
20	16	S Z DS 20-16	62,96	Z STA DS 20-16	34,29
25	16	S Z DS 25-16	97,00	Z STA DS 25-16	45,96
25	20	S Z DS 25-20	102,95	Z STA DS 25-20	44,14
30	20	S Z DS 30-20	136,89	Z STA DS 30-20	68,83
30	25	S Z DS 30-25	147,48	Z STA DS 30-25	68,60
38	25	S Z DS 38-25	167,91	Z STA DS 38-25	87,81
38	30	S Z DS 38-30	178,53	Z STA DS 38-30	79,38

Racores DIN 2353

DIN 2353 Pipe fittings
Raccords à bague DIN 2353
Raccordi DIN 2353

Crimping fittings for hoses

Pipe fittings

Pipe fittings II

Adaptors

Welding fittings

Industrial fittings

Accessories

Control components

Flow measuring

Tr/Me LOK

Racor unión en T tubo - tubo

Equal Tee

Raccord Té égal

Raccordo intermedio a T

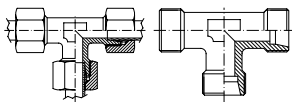

PIPE TUBO	SERIE	Part nº Referencia	€	Part Nº STA Referencia STA	€
4	LL	Z TLL 4	46,49		*
6	LL	Z TLL 6	47,02		*
8	LL	Z TLL 8	51,34		*
6	L	Z TL 6	29,85	Z STA TL 6	20,55
8	L	Z TL 8	31,29	Z STA TL 8	21,66
10	L	Z TL 10	35,41	Z STA TL 10	23,91
12	L	Z TL 12	40,04	Z STA TL 12	26,16
15	L	Z TL 15	54,26	Z STA TL 15	37,14
18	L	Z TL 18	78,19	Z STA TL 18	51,65
22	L	Z TL 22	104,60	Z STA TL 22	69,39
28	L	Z TL 28	161,86	Z STA TL 28	115,70
35	L	Z TL 35	260,83	Z STA TL 35	190,50
42	L	Z TL 42	354,30	Z STA TL 42	257,94
6	S	Z TS 6	33,08	Z STA TS 6	24,78
8	S	Z TS 8	36,45	Z STA TS 8	27,04
10	S	Z TS 10	41,82	Z STA TS 10	27,22
12	S	Z TS 12	52,83	Z STA TS 12	37,85
14	S	Z TS 14	80,81	Z STA TS 14	50,38
16	S	Z TS 16	73,67	Z STA TS 16	48,77
20	S	Z TS 20	109,44	Z STA TS 20	74,02
25	S	Z TS 25	178,84	Z STA TS 25	114,28
30	S	Z TS 30	275,57	Z STA TS 30	177,07
38	S	Z TS 38	376,79	Z STA TS 38	233,91

Racor unión en cruz tubo - tubo

Equal cross

Raccord croix égale

Raccordo intermedio a croce

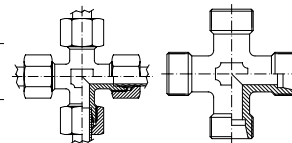

PIPE TUBO	SERIE	Part nº Referencia	€	Part Nº STA Referencia STA	€
6	L	Z KVL 6	65,17	Z STA KVL 6	56,98
8	L	Z KVL 8	67,66	Z STA KVL 8	58,15
10	L	Z KVL 10	94,22	Z STA KVL 10	81,87
12	L	Z KVL 12	81,83	Z STA KVL 12	65,79
15	L	Z KVL 15	131,77	Z STA KVL 15	116,91
18	L	Z KVL 18	140,92	Z STA KVL 18	127,47
22	L	Z KVL 22	175,75	Z STA KVL 22	153,71
28	L	Z KVL 28	228,85	Z STA KVL 28	168,45
35	L	Z KVL 35	553,06	Z STA KVL 35	467,50
42	L	Z KVL 42	538,02	Z STA KVL 42	475,91
6	S	Z KVS 6	64,57	Z STA KVS 6	50,84
8	S	Z KVS 8	77,48	Z STA KVS 8	67,57
10	S	Z KVS 10	85,82	Z STA KVS 10	71,60
12	S	Z KVS 12	105,10	Z STA KVS 12	90,82
14	S	Z KVS 14	153,44	Z STA KVS 14	135,18
16	S	Z KVS 16	134,32	Z STA KVS 16	116,12
20	S	Z KVS 20	186,88	Z STA KVS 20	149,30
25	S	Z KVS 25	258,69	Z STA KVS 25	155,23
30	S	Z KVS 30	363,71	Z STA KVS 30	230,38
38	S	Z KVS 38	543,21	Z STA KVS 38	430,12

Racores DIN 2353

DIN 2353 Pipe fittings
Raccords à bague DIN 2353
Raccordi DIN 2353

Racor recto rosca cilíndrica BSP cono 60°

Straight male stud coupling BSP cyl. 60°

Raccord Union simple mâle gaz cylindrique 60°

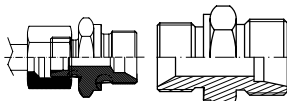

Raccordo di estremità diritto BSP 60°

T.	S.	THREAD ROSCA	Part nº Referencia	€	Part Nº STA Referencia STA	€
6	L	1/8" BSP	Z AL 6 RC 1/8	8,91	Z STA AL 6 RC 1/8	6,00
6	L	1/4" BSP	Z AL 6 RC 1/4	13,51	Z STA AL 6 RC 1/4	11,15
6	L	3/8" BSP	Z AL 6 RC 3/8	19,18	Z STA AL 6 RC 3/8	14,93
6	L	1/2" BSP	Z AL 6 RC 1/2	36,95	Z STA AL 6 RC 1/2	17,17
8	L	1/8" BSP	Z AL 8 RC 1/8	16,92	Z STA AL 8 RC 1/8	10,18
8	L	1/4" BSP	Z AL 8 RC 1/4	13,41	Z STA AL 8 RC 1/4	8,61
8	L	3/8" BSP	Z AL 8 RC 3/8	15,08	Z STA AL 8 RC 3/8	13,02
8	L	1/2" BSP	Z AL 8 RC 1/2	23,19	Z STA AL 8 RC 1/2	18,39
10	L	1/8" BSP	Z AL 10 RC 1/8	14,23	Z STA AL 10 RC 1/8	8,81
10	L	1/4" BSP	Z AL 10 RC 1/4	12,48	Z STA AL 10 RC 1/4	7,56
10	L	3/8" BSP	Z AL 10 RC 3/8	16,52	Z STA AL 10 RC 3/8	12,91
10	L	1/2" BSP	Z AL 10 RC 1/2	19,41	Z STA AL 10 RC 1/2	16,09
12	L	1/4" BSP	Z AL 12 RC 1/4	15,10	Z STA AL 12 RC 1/4	10,55
12	L	3/8" BSP	Z AL 12 RC 3/8	14,49	Z STA AL 12 RC 3/8	11,00
12	L	1/2" BSP	Z AL 12 RC 1/2	19,01	Z STA AL 12 RC 1/2	14,07
15	L	3/8" BSP	Z AL 15 RC 3/8	20,48	Z STA AL 15 RC 3/8	14,25
15	L	1/2" BSP	Z AL 15 RC 1/2	19,46	Z STA AL 15 RC 1/2	14,06
15	L	3/4" BSP	Z AL 15 RC 3/4	30,48	Z STA AL 15 RC 3/4	23,85
18	L	1/2" BSP	Z AL 18 RC 1/2	31,51	Z STA AL 18 RC 1/2	21,79
18	L	3/4" BSP	Z AL 18 RC 3/4	33,16	Z STA AL 18 RC 3/4	24,09
22	L	3/8" BSP	Z AL 22 RC 3/8	31,27	Z STA AL 22 RC 3/8	24,39
22	L	1/2" BSP	Z AL 22 RC 1/2	35,16	Z STA AL 22 RC 1/2	23,47
22	L	3/4" BSP	Z AL 22 RC 3/4	32,85	Z STA AL 22 RC 3/4	21,78
22	L	1" BSP	Z AL 22 RC 1	44,81	Z STA AL 22 RC 1	31,20
28	L	3/4" BSP	Z AL 28 RC 3/4	49,79	Z STA AL 28 RC 3/4	30,23
28	L	1" BSP	Z AL 28 RC 1	50,78	Z STA AL 28 RC 1	31,38
35	L	1" 1/4 BSP	Z AL 35 RC 1 1/4	85,77	Z STA AL 35 RC 1 1/4	50,26
35	L	1" 1/2 BSP	Z AL 35 RC 1 1/2	107,45	Z STA AL 35 RC 1 1/2	65,38
42	L	1" 1/4 BSP	Z AL 42 RC 1 1/4	126,64	Z STA AL 42 RC 1 1/4	77,82
42	L	1" 1/2 BSP	Z AL 42 RC 1 1/2	115,16	Z STA AL 42 RC 1 1/2	66,34
6	S	1/4" BSP	Z AS 6 RC 1/4	20,32	Z STA AS 6 RC 1/4	13,06
6	S	3/8" BSP	Z AS 6 RC 3/8	19,30	Z STA AS 6 RC 3/8	14,34
8	S	1/4" BSP	Z AS 8 RC 1/4	15,10	Z STA AS 8 RC 1/4	10,39
8	S	3/8" BSP	Z AS 8 RC 3/8	18,41	Z STA AS 8 RC 3/8	18,74
8	S	1/2" BSP	Z AS 8 RC 1/2	25,89	Z STA AS 8 RC 1/2	21,70
10	S	1/4" BSP	Z AS 10 RC 1/4	16,99	Z STA AS 10 RC 1/4	10,87
10	S	3/8" BSP	Z AS 10 RC 3/8	23,19	Z STA AS 10 RC 3/8	12,22
10	S	1/2" BSP	Z AS 10 RC 1/2	29,66	Z STA AS 10 RC 1/2	18,92
12	S	1/4" BSP	Z AS 12 RC 1/4	20,08	Z STA AS 12 RC 1/4	16,06
12	S	3/8" BSP	Z AS 12 RC 3/8	18,67	Z STA AS 12 RC 3/8	14,29
12	S	1/2" BSP	Z AS 12 RC 1/2	26,63	Z STA AS 12 RC 1/2	17,78
14	S	3/8" BSP	Z AS 14 RC 3/8	29,57	Z STA AS 14 RC 3/8	19,47
14	S	1/2" BSP	Z AS 14 RC 1/2	26,80	Z STA AS 14 RC 1/2	19,00
16	S	3/8" BSP	Z AS 16 RC 3/8	29,00	Z STA AS 16 RC 3/8	23,01
16	S	1/2" BSP	Z AS 16 RC 1/2	26,11	Z STA AS 16 RC 1/2	16,71
16	S	3/4" BSP	Z AS 16 RC 3/4	35,86	Z STA AS 16 RC 3/4	24,14
20	S	3/8" BSP	Z AS 20 RC 3/8	46,58	Z STA AS 20 RC 3/8	30,35
20	S	1/2" BSP	Z AS 20 RC 1/2	38,98	Z STA AS 20 RC 1/2	24,81
20	S	3/4" BSP	Z AS 20 RC 3/4	38,27	Z STA AS 20 RC 3/4	24,12
20	S	1" BSP	Z AS 20 RC 1	56,54	Z STA AS 20 RC 1	45,35
25	S	3/4" BSP	Z AS 25 RC 3/4	61,88	Z STA AS 25 RC 3/4	38,33
25	S	1" BSP	Z AS 25 RC 1	66,82	Z STA AS 25 RC 1	41,52
25	S	1" 1/4 BSP	Z AS 25 RC 1 1/4	87,77	Z STA AS 25 RC 1 1/4	52,95
30	S	1" BSP	Z AS 30 RC 1	83,78	Z STA AS 30 RC 1	47,70
30	S	1" 1/4 BSP	Z AS 30 RC 1 1/4	100,58	Z STA AS 30 RC 1 1/4	56,52
30	S	1" 1/2 BSP	Z AS 30 RC 1 1/2	108,26	Z STA AS 30 RC 1 1/2	70,38
38	S	1" 1/4 BSP	Z AS 38 RC 1 1/4	118,24	Z STA AS 38 RC 1 1/4	72,84
38	S	1" 1/2 BSP	Z AS 38 RC 1 1/2	124,28	Z STA AS 38 RC 1 1/2	79,00

Racor recto rosca cilíndrica BSP con junta

Straight male stud coupling BSP cylindrical with captive seal

Raccord union simple mâle gaz cylindrique avec joint plat

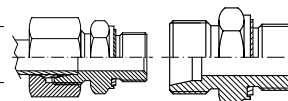

Raccordo di estremità diritto BSP con guarnizione

T.	S.	THREAD ROSCA	Part nº Referencia	€	Part Nº STA Referencia STA	€
6	L	1/8" BSP	Z AL 6 R 1/8WD	11,69	Z STA AL 6 R 1/8WD	10,19
6	L	1/4" BSP	Z AL 6 R 1/4WD	14,12	Z STA AL 6 R 1/4WD	12,23
6	L	3/8" BSP	Z AL 6 R 3/8WD	17,43	Z STA AL 6 R 3/8WD	13,18
8	L	1/8" BSP	Z AL 8 R 1/8WD	14,07	Z STA AL 8 R 1/8WD	10,89
8	L	1/4" BSP	Z AL 8 R 1/4WD	13,57	Z STA AL 8 R 1/4WD	10,20
8	L	3/8" BSP	Z AL 8 R 3/8WD	15,03	Z STA AL 8 R 3/8WD	13,82
8	L	1/2" BSP	Z AL 8 R 1/2WD	20,41	Z STA AL 8 R 1/2WD	15,61
10	L	1/8" BSP	Z AL 10 R 1/8WD	16,06	Z STA AL 10 R 1/8WD	14,58
10	L	1/4" BSP	Z AL 10 R 1/4WD	15,22	Z STA AL 10 R 1/4WD	11,18
10	L	3/8" BSP	Z AL 10 R 3/8WD	16,74	Z STA AL 10 R 3/8WD	14,70
10	L	1/2" BSP	Z AL 10 R 1/2WD	21,84	Z STA AL 10 R 1/2WD	19,57
12	L	1/4" BSP	Z AL 12 R 1/4WD	16,93	Z STA AL 12 R 1/4WD	13,36
12	L	3/8" BSP	Z AL 12 R 3/8WD	17,02	Z STA AL 12 R 3/8WD	13,18
12	L	1/2" BSP	Z AL 12 R 1/2WD	20,96	Z STA AL 12 R 1/2WD	17,59
15	L	3/8" BSP	Z AL 15 R 3/8WD	21,84	Z STA AL 15 R 3/8WD	17,19
15	L	1/2" BSP	Z AL 15 R 1/2WD	21,95	Z STA AL 15 R 1/2WD	14,80
15	L	3/4" BSP	Z AL 15 R 3/4WD	30,89	Z STA AL 15 R 3/4WD	23,99
18	L	3/8" BSP	Z AL 18 R 3/8WD	34,50	Z STA AL 18 R 3/8WD	24,79
18	L	1/2" BSP	Z AL 18 R 1/2WD	23,73	Z STA AL 18 R 1/2WD	15,91
18	L	3/4" BSP	Z AL 18 R 3/4WD	34,40	Z STA AL 18 R 3/4WD	26,45
22	L	1/2" BSP	Z AL 22 R 1/2WD	38,27	Z STA AL 22 R 1/2WD	25,71
22	L	3/4" BSP	Z AL 22 R 3/4WD	30,24	Z STA AL 22 R 3/4WD	21,24
22	L	1" BSP	Z AL 22 R 1WD	47,43	Z STA AL 22 R 1WD	38,86
28	L	3/4" BSP	Z AL 28 R 3/4WD	56,26	Z STA AL 28 R 3/4WD	37,13
28	L	1" BSP	Z AL 28 R 1WD	52,84	Z STA AL 28 R 1WD	32,86
35	L	1" BSP	Z AL 35 R 1WD	88,90	Z STA AL 35 R 1WD	53,92
35	L	1" 1/4 BSP	Z AL 35 R 1 1/4WD	90,95	Z STA AL 35 R 1 1/4WD	65,09
42	L	1" 1/2 BSP	Z AL 42 R 1 1/2WD	107,68	Z STA AL 42 R 1 1/2WD	70,75
6	S	1/4" BSP	Z AS 6 R 1/4WD	19,30	Z STA AS 6 R 1/4WD	15,93
8	S	1/4" BSP	Z AS 8 R 1/4WD	17,10	Z STA AS 8 R 1/4WD	13,96
8	S	3/8" BSP	Z AS 8 R 3/8WD	22,05	Z STA AS 8 R 3/8WD	17,40
8	S	1/2" BSP	Z AS 8 R 1/2WD	24,18	Z STA AS 8 R 1/2WD	18,81
10	S	1/4" BSP	Z AS 10 R 1/4WD	18,78	Z STA AS 10 R 1/4WD	15,07
10	S	3/8" BSP	Z AS 10 R 3/8WD	23,32	Z STA AS 10 R 3/8WD	18,58
10	S	1/2" BSP	Z AS 10 R 1/2WD	28,57	Z STA AS 10 R 1/2WD	24,33
12	S	1/4" BSP	Z AS 12 R 1/4WD	24,65	Z STA AS 12 R 1/4WD	19,06
12	S	3/8" BSP	Z AS 12 R 3/8WD	18,47	Z STA AS 12 R 3/8WD	12,91
12	S	1/2" BSP	Z AS 12 R 1/2WD	26,90	Z STA AS 12 R 1/2WD	22,70
14	S	3/8" BSP	Z AS 14 R 3/8WD	33,40	Z STA AS 14 R 3/8WD	26,61
14	S	1/2" BSP	Z AS 14 R 1/2WD	28,01	Z STA AS 14 R 1/2WD	22,15
16	S	3/8" BSP	Z AS 16 R 3/8WD	29,65	Z STA AS 16 R 3/8WD	20,00
16	S	1/2" BSP	Z AS 16 R 1/2WD	26,78	Z STA AS 16 R 1/2WD	18,37
16	S	3/4" BSP	Z AS 16 R 3/4WD	34,24	Z STA AS 16 R 3/4WD	26,56
20	S	1/2" BSP	Z AS 20 R 1/2WD	35,06	Z STA AS 20 R 1/2WD	25,93
20	S	3/4" BSP	Z AS 20 R 3/4WD	35,28	Z STA AS 20 R 3/4WD	25,59
25	S	3/4" BSP	Z AS 25 R 3/4WD	58,55	Z STA AS 25 R 3/4WD	45,59
25	S	1" BSP	Z AS 25 R 1WD	66,01	Z STA AS 25 R 1WD	51,42
25	S	1" 1/4 BSP	Z AS 25 R 1 1/4WD	105,25	Z STA AS 25 R 1 1/4WD	70,43
30	S	1" BSP	Z AS 30 R 1WD	85,91	Z STA AS 30 R 1WD	46,63
30	S	1" 1/4 BSP	Z AS 30 R 1 1/4WD	91,29	Z STA AS 30 R 1 1/4WD	64,42
30	S	1" 1/2 BSP	Z AS 30 R 1 1/2WD	148,71	Z STA AS 30 R 1 1/2WD	107,56
38	S	1" 1/4 BSP	Z AS 38 R 1 1/4WD	135,90	Z STA AS 38 R 1 1/4WD	90,63
38	S	1" 1/2 BSP	Z AS 38 R 1 1/2WD	129,34	Z STA AS 38 R 1 1/2WD	81,58

Racores DIN 2353

DIN 2353 Pipe fittings
Raccords à bague DIN 2353
Raccordi DIN 2353

Racor recto rosca cilíndrica BSP

Straight male stud coupling BSP cylindrical

Raccord union simple gaz cylindrique mâle

Raccordo di estremità diritto BSP

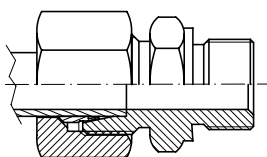

PIPE TUBO	SERIE	THREAD ROSCA	Part nº Referencia	€
10	L	1/8" BSP	Z AL 10 R 1/8	14,23
15	L	3/4" BSP	Z AL 15 R 3/4	27,99
18	L	1/2" BSP	Z AL 18 R 1/2	24,28
6	S	1/4" BSP	Z AS 6 R 1/4	15,11
6	S	3/8" BSP	Z AS 6 R 3/8	19,30
8	S	1/4" BSP	Z AS 8 R 1/4	14,52
8	S	3/8" BSP	Z AS 8 R 3/8	18,41
8	S	1/2" BSP	Z AS 8 R 1/2	26,20
10	S	1/4" BSP	Z AS 10 R 1/4	16,34
10	S	3/8" BSP	Z AS 10 R 3/8	16,73
10	S	1/2" BSP	Z AS 10 R 1/2	28,52
12	S	1/4" BSP	Z AS 12 R 1/4	20,08
14	S	3/8" BSP	Z AS 14 R 3/8	23,93
14	S	1/2" BSP	Z AS 14 R 1/2	25,54
30	S	1"1/2 BSP	Z AS 30 R 1 1/2	125,28
38	S	1"1/4 BSP	Z AS 38 R 1 1/4	122,97

Hasta fin de existencias / Until end of stock / Jusqu'à la fin du stock. / Fino ad esaurimento scorta

Racor recto rosca cilíndrica Métrica con junta

Straight male stud coupling Metric cylindrical with captive seal

Raccord union simple mâle cylindrique Métrique avec joint plat

Raccordo di estremità diritto Metrico con guarnizione

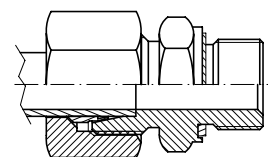

PIPE TUBO	SERIE	THREAD ROSCA	Part nº Referencia	€
6	L	M10x1	Z AL 6 M 10X1 WD	11,52
8	L	M12x1.5	Z AL 8 M 12X1.5 WD	16,09
10	L	M14x1.5	Z AL 10 M 12X1.5 WD	20,35
10	L	M14x1.5	Z AL 10 M 14X1.5 WD	20,81
10	L	M16x1.5	Z AL 10 M 16X1.5 WD	21,03
12	L	M16x1.5	Z AL 12 M 16X1.5 WD	23,06
12	L	M18x1.5	Z AL 12 M 18X1.5 WD	20,81
12	L	M22x1.5	Z AL 12 M 22X1.5 WD	27,56
15	L	M18x1.5	Z AL 15 M 18X1.5 WD	30,25
18	L	M22x1.5	Z AL 18 M 22X1.5 WD	30,60
22	L	M26x1.5	Z AL 22 M 26X1.5 WD	43,07
28	L	M33x2	Z AL 28 M 33X2 WD	61,86
35	L	M42x2	Z AL 35 M 42X2 WD	103,93
42	L	M48x2	Z AL 42 M 48X2 WD	135,62
6	S	M12x1.5	Z AS 6 M 12X1.5 WD	22,01
6	S	M14x1.5	Z AS 6 M 14X1.5 WD	22,64
8	S	M14x1.5	Z AS 8 M 14X1.5 WD	25,37
10	S	M16x1.5	Z AS 10 M 16X1.5 WD	24,50
12	S	M14x1.5	Z AS 12 M 14X1.5 WD	25,98
12	S	M18x1.5	Z AS 12 M 18X1.5 WD	24,63
14	S	M20x1.5	Z AS 14 M 20X1.5 WD	34,80
16	S	M22x1.5	Z AS 16 M 22X1.5 WD	36,13
20	S	M27x2	Z AS 20 M 27X2 WD	43,19
25	S	M33x2	Z AS 25 M 33X2 WD	68,05
30	S	M42x2	Z AS 30 M 42X2 WD	98,74
38	S	M48x2	Z AS 38 M 48X2 WD	155,84

Racor recto rosca UNF

Straight male stud coupling UNF

Raccord union simple mâle UNF

Raccordo di estremità diritto UNF

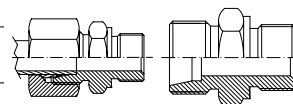

T.	S.	THREAD ROSCA	Part nº Referencia	€	Part Nº STA Referencia STA	€
8	L	7/16" UNF	Z AL 8 7/16 UNF	15,82	Z STA AL 8 7/16 UNF	10,12
10	L	7/16" UNF	Z AL 10 7/16 UNF	20,94	Z STA AL 10 7/16 UNF	10,98
12	L	3/4" UNF	Z AL 12 3/4 UNF	23,95	Z STA AL 12 3/4 UNF	19,28
12	L	9/16" UNF	Z AL 12 9/16 UNF	19,96	Z STA AL 12 9/16 UNF	15,13
15	L	3/4" UNF	Z AL 15 3/4 UNF	29,21	Z STA AL 15 3/4 UNF	21,10
18	L	7/8" UNF	Z AL 18 7/8 UNF	34,77	Z STA AL 18 7/8 UNF	24,03
22	L	1" 1/16 UNF	Z AL 22 1 1/16 UNF	44,18	Z STA AL 22 1 1/16 UNF	30,45
28	L	1" 5/16 UNF	Z AL 28 1 5/16 UNF	73,22	Z STA AL 28 1 5/16 UNF	46,52
35	L	1" 5/8 UNF	Z AL 35 1 5/8 UNF	131,18	Z STA AL 35 1 5/8 UNF	72,55
8	S	7/16" UNF	Z AS 8 7/16 UNF	19,31	Z STA AS 8 7/16 UNF	13,82
10	S	9/16" UNF	Z AS 10 9/16 UNF	25,34	Z STA AS 10 9/16 UNF	16,45
12	S	9/16" UNF	Z AS 12 9/16 UNF	27,00	Z STA AS 12 9/16 UNF	20,66
16	S	3/4" UNF	Z AS 16 3/4 UNF	40,33	Z STA AS 16 3/4 UNF	25,31
20	S	7/8" UNF	Z AS 20 7/8 UNF	55,68	Z STA AS 20 7/8 UNF	35,43
25	S	1" 5/16 UNF	Z AS 25 1 5/16 UNF	92,07	Z STA AS 25 1 5/16 UNF	58,39
30	S	1" 5/16 UNF	Z AS 30 1 5/16 UNF	120,20	Z STA AS 30 1 5/16 UNF	71,17
38	S	1" 5/8 UNF	Z AS 38 1 5/8 UNF	198,92	Z STA AS 38 1 5/8 UNF	107,45

Racores DIN 2353

DIN 2353 Pipe fittings
Raccords à bague DIN 2353
Raccordi DIN 2353

Racor recto rosca cónica NPT

Straight male stud coupling NPT

Raccord union simple mâle NPT

Raccordo di estremità diritto NPT

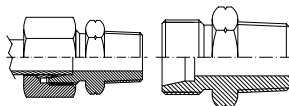

T.	S.	THREAD ROSCA	Part nº Referencia	€	Part Nº STA Referencia STA	€
6	L	1/8"NPT	Z AKL 6 1/8 NPT	12,26	Z STA AKL 6 1/8 NPT	9,57
6	L	1/4"NPT	Z AKL 6 1/4 NPT	18,06	Z STA AKL 6 1/4 NPT	14,48
6	L	3/8"NPT	Z AKL 6 3/8 NPT	18,80	Z STA AKL 6 3/8 NPT	15,41
8	L	1/8"NPT	Z AKL 8 1/8 NPT	13,37	Z STA AKL 8 1/8 NPT	10,34
8	L	1/4"NPT	Z AKL 8 1/4 NPT	13,45	Z STA AKL 8 1/4 NPT	10,38
8	L	3/8"NPT	Z AKL 8 3/8 NPT	18,36	Z STA AKL 8 3/8 NPT	14,10
8	L	1/2"NPT	Z AKL 8 1/2 NPT	21,46	Z STA AKL 8 1/2 NPT	16,66
10	L	1/4"NPT	Z AKL 10 1/4 NPT	13,63	Z STA AKL 10 1/4 NPT	10,68
10	L	3/8"NPT	Z AKL 10 3/8 NPT	17,77	Z STA AKL 10 3/8 NPT	11,76
10	L	1/2"NPT	Z AKL 10 1/2 NPT	23,94	Z STA AKL 10 1/2 NPT	19,70
12	L	1/4"NPT	Z AKL 12 1/4 NPT	16,22	Z STA AKL 12 1/4 NPT	13,49
12	L	3/8"NPT	Z AKL 12 3/8 NPT	18,46	Z STA AKL 12 3/8 NPT	13,81
12	L	1/2"NPT	Z AKL 12 1/2 NPT	19,99	Z STA AKL 12 1/2 NPT	15,60
15	L	3/8"NPT	Z AKL 15 3/8 NPT	25,03	Z STA AKL 15 3/8 NPT	19,35
15	L	1/2"NPT	Z AKL 15 1/2 NPT	24,07	Z STA AKL 15 1/2 NPT	19,40
18	L	1/2"NPT	Z AKL 18 1/2 NPT	29,90	Z STA AKL 18 1/2 NPT	24,41
18	L	3/4"NPT	Z AKL 18 3/4 NPT	37,12	Z STA AKL 18 3/4 NPT	28,66
22	L	3/4"NPT	Z AKL 22 3/4 NPT	40,38	Z STA AKL 22 3/4 NPT	26,04
28	L	1"NPT	Z AKL 28 1 NPT	65,52	Z STA AKL 28 1 NPT	36,45
35	L	1 1/4"NPT	Z AKL 35 1 1/4 NPT	86,61	Z STA AKL 35 1 1/4 NPT	47,37
42	L	1 1/2"NPT	Z AKL 42 1 1/2 NPT	129,91	Z STA AKL 42 1 1/2 NPT	81,09
6	S	1/8"NPT	Z AKS 6 1/8 NPT	18,23	Z STA AKS 6 1/8 NPT	13,27
6	S	1/4"NPT	Z AKS 6 1/4 NPT	17,43	Z STA AKS 6 1/4 NPT	12,66
6	S	3/8"NPT	Z AKS 6 3/8 NPT	22,60	Z STA AKS 6 3/8 NPT	18,42
8	S	1/4"NPT	Z AKS 8 1/4 NPT	18,11	Z STA AKS 8 1/4 NPT	13,34
8	S	3/8"NPT	Z AKS 8 3/8 NPT	23,62	Z STA AKS 8 3/8 NPT	18,25
8	S	1/2"NPT	Z AKS 8 1/2 NPT	24,18	Z STA AKS 8 1/2 NPT	17,95
10	S	1/4"NPT	Z AKS 10 1/4 NPT	21,37	Z STA AKS 10 1/4 NPT	14,65
10	S	3/8"NPT	Z AKS 10 3/8 NPT	21,03	Z STA AKS 10 3/8 NPT	14,31
10	S	1/2"NPT	Z AKS 10 1/2 NPT	24,27	Z STA AKS 10 1/2 NPT	18,68
12	S	1/4"NPT	Z AKS 12 1/4 NPT	23,06	Z STA AKS 12 1/4 NPT	15,81
12	S	3/8"NPT	Z AKS 12 3/8 NPT	25,60	Z STA AKS 12 3/8 NPT	18,36
12	S	1/2"NPT	Z AKS 12 1/2 NPT	26,04	Z STA AKS 12 1/2 NPT	18,79
14	S	1/2"NPT	Z AKS 14 1/2 NPT	32,75	Z STA AKS 14 1/2 NPT	24,66
16	S	1/2"NPT	Z AKS 16 1/2 NPT	32,32	Z STA AKS 16 1/2 NPT	25,22
16	S	3/4"NPT	Z AKS 16 3/4 NPT	36,49	Z STA AKS 16 3/4 NPT	26,32
20	S	1/2"NPT	Z AKS 20 1/2 NPT	46,11	Z STA AKS 20 1/2 NPT	29,65
20	S	3/4"NPT	Z AKS 20 3/4 NPT	59,61	Z STA AKS 20 3/4 NPT	45,66
20	S	1"NPT	Z AKS 20 1 NPT	62,16	Z STA AKS 20 1 NPT	45,77
25	S	3/4"NPT	Z AKS 25 3/4 NPT	79,86	Z STA AKS 25 3/4 NPT	49,20
25	S	1"NPT	Z AKS 25 1 NPT	71,08	Z STA AKS 25 1 NPT	45,65
30	S	1"NPT	Z AKS 30 1 NPT	121,57	Z STA AKS 30 1 NPT	77,51
30	S	1 1/4"NPT	Z AKS 30 1 1/4 NPT	96,73	Z STA AKS 30 1 1/4 NPT	52,67
38	S	1 1/2"NPT	Z AKS 38 1 1/2 NPT	134,97	Z STA AKS 38 1 1/2 NPT	89,69

Racor recto rosca cónica BSPT

Straight male stud coupling BSPT

Raccord union simple mâle conique

Raccordo di estremità diritto BSP conico

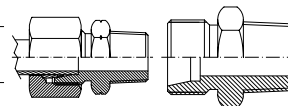

T.	S.	THREAD ROSCA	Part nº Referencia	€	Part Nº STA Referencia STA	€
6	LL	1/8" BSPT	Z AKLL 6 R 1/8	*		*
8	LL	1/8" BSPT	Z AKLL 8 R 1/8	*		*
6	L	1/8" BSPT	Z AKL 6 R 1/8	11,68	Z STA AKL 6 R 1/8	8,90
6	L	1/4" BSPT	Z AKL 6 R 1/4	11,96	Z STA AKL 6 R 1/4	8,39
8	L	1/8" BSPT	Z AKL 8 R 1/8	14,62	Z STA AKL 8 R 1/8	9,82
8	L	1/4" BSPT	Z AKL 8 R 1/4	12,14	Z STA AKL 8 R 1/4	9,13
8	L	3/8" BSPT	Z AKL 8 R 3/8	16,54	Z STA AKL 8 R 3/8	11,74
10	L	1/4" BSPT	Z AKL 10 R 1/4	13,29	Z STA AKL 10 R 1/4	10,22
10	L	3/8" BSPT	Z AKL 10 R 3/8	13,71	Z STA AKL 10 R 3/8	10,14
10	L	1/2" BSPT	Z AKL 10 R 1/2	20,25	Z STA AKL 10 R 1/2	14,11
12	L	1/4" BSPT	Z AKL 12 R 1/4	16,40	Z STA AKL 12 R 1/4	13,01
12	L	3/8" BSPT	Z AKL 12 R 3/8	15,62	Z STA AKL 12 R 3/8	12,88
12	L	1/2" BSPT	Z AKL 12 R 1/2	18,35	Z STA AKL 12 R 1/2	14,25
15	L	3/8" BSPT	Z AKL 15 R 3/8	24,18	Z STA AKL 15 R 3/8	16,57
15	L	1/2" BSPT	Z AKL 15 R 1/2	21,93	Z STA AKL 15 R 1/2	16,62
18	L	1/2" BSPT	Z AKL 18 R 1/2	25,88	Z STA AKL 18 R 1/2	18,55
22	L	3/4" BSPT	Z AKL 22 R 3/4	32,31	Z STA AKL 22 R 3/4	23,42
28	L	1" BSPT	Z AKL 28 R 1	61,30	Z STA AKL 28 R 1	46,52
35	L	1 1/4" BSPT	Z AKL 35 R 1 1/4	80,98	Z STA AKL 35 R 1 1/4	52,87
42	L	1 1/4" BSPT	Z AKL 42 R 1 1/4	110,64	Z STA AKL 42 R 1 1/4	61,82
6	S	1/4" BSPT	Z AKS 6 R 1/4	17,16	Z STA AKS 6 R 1/4	12,27
8	S	1/4" BSPT	Z AKS 8 R 1/4	15,93	Z STA AKS 8 R 1/4	11,42
10	S	3/8" BSPT	Z AKS 10 R 3/8	31,69	Z STA AKS 10 R 3/8	25,04
14	S	1/2" BSPT	Z AKS 14 R 1/2	43,46	Z STA AKS 14 R 1/2	32,81
16	S	1/2" BSPT	Z AKS 16 R 1/2	36,49	Z STA AKS 16 R 1/2	24,47
20	S	3/4" BSPT	Z AKS 20 R 3/4	52,00	Z STA AKS 20 R 3/4	35,54
25	S	1" BSPT	Z AKS 25 R 1	69,89	Z STA AKS 25 R 1	38,82
30	S	1 1/4" BSPT	Z AKS 30 R 1 1/4	139,98	Z STA AKS 30 R 1 1/4	95,92

Racor recto rosca cónica Métrica

Straight male stud coupling Metric tapered

Raccord union simple mâle Métrique conique

Raccordo di estremità diritto Metrico conico

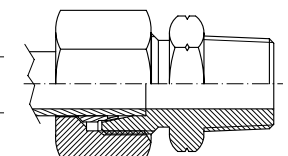

PIPE TUBO	SERIE	THREAD ROSCA	Part nº Referencia	€
6	LL	M10X1	Z AKLL 6 M10X1	14,85
6	L	M10X1	Z AKL 6 M 10X1	14,97
8	L	M12X1.5	Z AKL 8 M 12X1.5	19,30
10	L	M14X1.5	Z AKL 10 M 14X1.5	21,51
12	L	M16X1.5	Z AKL 12 M 16X1.5	22,60
15	L	M18X1.5	Z AKL 15 M 18X1.5	30,93
18	L	M22X1.5	Z AKL 18 M 22X1.5	40,45
22	L	M26X1.5	Z AKL 22 M 26X1.5	36,88

Racores DIN 2353

DIN 2353 Pipe fittings
Raccords à bague DIN 2353
Raccordi DIN 2353

Racor en codo rosca cónica BSPT

Male stud elbow BSPT

Raccord union coude mâle gaz conique

Raccordo di estremità a 90° BSP conico

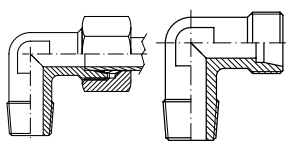

T.	S.	THREAD ROSCA	Part n° Referencia	€	Part N° STA Referencia STA	€
6	LL	1/8" BSPT	Z CKL 6 R 1/8	23,67		*
6	L	1/8" BSPT	Z CKL 6 R 1/8	18,55	Z STA CKL 6 R 1/8	13,95
6	L	1/4" BSPT	Z CKL 6 R 1/4	18,08	Z STA CKL 6 R 1/4	13,68
8	L	1/8" BSPT	Z CKL 8 R 1/8	21,88	Z STA CKL 8 R 1/8	19,13
8	L	1/4" BSPT	Z CKL 8 R 1/4	19,93	Z STA CKL 8 R 1/4	18,08
8	L	3/8" BSPT	Z CKL 8 R 3/8	26,72	Z STA CKL 8 R 3/8	23,28
8	L	1/2" BSPT	Z CKL 8 R 1/2	37,62	Z STA CKL 8 R 1/2	32,82
10	L	1/8" BSPT	Z CKL 10 R 1/8	31,39	Z STA CKL 10 R 1/8	30,25
10	L	1/4" BSPT	Z CKL 10 R 1/4	22,38	Z STA CKL 10 R 1/4	19,20
10	L	3/8" BSPT	Z CKL 10 R 3/8	21,93	Z STA CKL 10 R 3/8	20,68
10	L	1/2" BSPT	Z CKL 10 R 1/2	27,98	Z STA CKL 10 R 1/2	21,95
12	L	1/4" BSPT	Z CKL 12 R 1/4	26,66	Z STA CKL 12 R 1/4	21,32
12	L	3/8" BSPT	Z CKL 12 R 3/8	26,88	Z STA CKL 12 R 3/8	23,45
12	L	1/2" BSPT	Z CKL 12 R 1/2	29,81	Z STA CKL 12 R 1/2	29,18
15	L	3/8" BSPT	Z CKL 15 R 3/8	42,67	Z STA CKL 15 R 3/8	34,21
15	L	1/2" BSPT	Z CKL 15 R 1/2	38,92	Z STA CKL 15 R 1/2	26,71
18	L	1/2" BSPT	Z CKL 18 R 1/2	51,85	Z STA CKL 18 R 1/2	41,11
22	L	3/4" BSPT	Z CKL 22 R 3/4	86,27	Z STA CKL 22 R 3/4	74,21
28	L	1" BSPT	Z CKL 28 R 1	184,66	Z STA CKL 28 R 1	156,85
35	L	1 1/4" BSPT	Z CKL 35 R 1 1/4	236,57	Z STA CKL 35 R 1 1/4	193,42
42	L	1 1/2" BSPT	Z CKL 42 R 1 1/2 *	265,39		*
6	S	1/4" BSPT	Z CKS 6 R 1/4	22,58	Z STA CKS 6 R 1/4	18,20
8	S	1/4" BSPT	Z CKS 8 R 1/4	26,14	Z STA CKS 8 R 1/4	22,41
8	S	3/8" BSPT	Z CKS 8 R 3/8 *	30,93		*
8	S	1/2" BSPT	Z CKS 8 R 1/2	30,82	Z STA CKS 8 R 1/2	25,45
10	S	1/4" BSPT	Z CKS 10 R 1/4	39,23	Z STA CKS 10 R 1/4	33,75
10	S	3/8" BSPT	Z CKS 10 R 3/8	31,43	Z STA CKS 10 R 3/8	22,39
10	S	1/2" BSPT	Z CKS 10 R 1/2 *	48,93		*
12	S	3/8" BSPT	Z CKS 12 R 3/8	37,48	Z STA CKS 12 R 3/8	32,05
14	S	1/2" BSPT	Z CKS 14 R 1/2	49,85	Z STA CKS 14 R 1/2	36,60
16	S	1/2" BSPT	Z CKS 16 R 1/2	57,65	Z STA CKS 16 R 1/2	43,98
20	S	3/4" BSPT	Z CKS 20 R 3/4	87,91	Z STA CKS 20 R 3/4	122,83
25	S	1" BSPT	Z CKS 25 R 1	153,35	Z STA CKS 25 R 1	129,12
30	S	1 1/4" BSPT	Z CKS 30 R 1 1/4	265,71	Z STA CKS 30 R 1 1/4	221,65
38	S	1 1/2" BSPT	Z CKS 38 R 1 1/2	388,56	Z STA CKS 38 R 1 1/2	343,28

*Hasta fin de existencias. / *Until end of stock. / *Jusqu'à la fin du stock. / *Fino ad esaurimento scorta.

Racor en codo orientable BSP

90° Adjustable male stud elbow BSP

Coude orientable mâle BSP

Raccordo a 90° orientabile maschio BSP

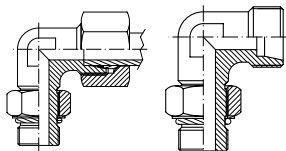

T.	S.	THREAD ROSCA	Part n° Referencia	€	Part N° STA Referencia STA	€
6	L	1/8" BSP	Z WEE 6L R 1/8	21,76	Z STA WEE 6L R 1/8	20,20
8	L	1/4" BSP	Z WEE 8L R 1/4	31,52	Z STA WEE 8L R 1/4	29,71
10	L	1/4" BSP	Z WEE 10L R 1/4	35,07	Z STA WEE 10L R 1/4	31,99
12	L	3/8" BSP	Z WEE 12L R 3/8	45,94	Z STA WEE 12L R 3/8	43,27
15	L	1/2" BSP	Z WEE 15L R 1/2	85,51	Z STA WEE 15L R 1/2	84,04
18	L	1/2" BSP	Z WEE 18L R 1/2	87,23	Z STA WEE 18L R 1/2	87,10
22	L	3/4" BSP	Z WEE 22L R 3/4	107,70	Z STA WEE 22L R 3/4	102,04
16	S	1/2" BSP	Z WEE 16S R 1/2	81,56	Z STA WEE 16S R 1/2	75,85
20	S	3/4" BSP	Z WEE 20S R 3/4	123,14	Z STA WEE 20S R 3/4	115,75
25	S	1" BSP	Z WEE 25S R 1	190,86	Z STA WEE 25S R 1	175,70

Racor en codo rosca cónica NPT

Male stud elbow NPT

Raccord union coude mâle NPT

Raccordo di estremità a 90° NPT

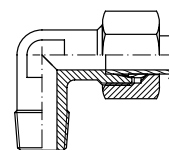

PIPE TUBO	SERIE	THREAD ROSCA	Part n° Referencia	€
6	L	1/8" NPT	Z CKL 6 1/8 NPT	20,60
6	L	1/4" NPT	Z CKL 6 1/4 NPT	21,10
8	L	1/4" NPT	Z CKL 8 1/4 NPT	21,50
10	L	1/4" NPT	Z CKL 10 1/4 NPT	24,13
12	L	1/4" NPT	Z CKL 12 1/4 NPT	31,15
12	L	3/8" NPT	Z CKL 12 3/8 NPT	31,49
12	L	1/2" NPT	Z CKL 12 1/2 NPT	33,63
15	L	1/2" NPT	Z CKL 15 1/2 NPT	39,36
18	L	1/2" NPT	Z CKL 18 1/2 NPT	68,23
22	L	3/4" NPT	Z CKL 22 3/4 NPT	73,32
28	L	1" NPT	Z CKL 28 1 NPT	115,15
35	L	1 1/4" NPT	Z CKL 35 1 1/4 NPT	238,16
42	L	1 1/2" NPT	Z CKL 42 1 1/2 NPT	295,31
6	S	1/4" NPT	Z CKS 6 1/4 NPT	24,52
8	S	1/4" NPT	Z CKS 8 1/4 NPT	30,93
10	S	3/8" NPT	Z CKS 10 3/8 NPT	37,76
12	S	3/8" NPT	Z CKS 12 3/8 NPT	35,99
12	S	1/2" NPT	Z CKS 12 1/2 NPT	34,90
14	S	1/2" NPT	Z CKS 14 1/2 NPT	58,29
16	S	1/2" NPT	Z CKS 16 1/2 NPT	58,24
20	S	3/4" NPT	Z CKS 20 3/4 NPT	77,33
25	S	1" NPT	Z CKS 25 1 NPT	156,76
30	S	1 1/4" NPT	Z CKS 30 1 1/4 NPT	297,41
38	S	1 1/2" NPT	Z CKS 38 1 1/2 NPT	296,82

Racor en codo rosca cónica Métrica

Male stud elbow metric tapered

Raccord équerre mâle métrique

Raccordo di estremità a 90° Metrico conico

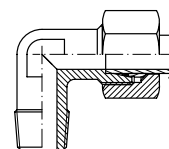

PIPE TUBO	SERIE	THREAD ROSCA	Part n° Referencia	€
6	L	M10X1	Z CKL 6 M 10X1	24,13
8	L	M12X1.5	Z CKL 8 M 12X1.5	29,90
10	L	M14X1.5	Z CKL 10 M 14X1.5	32,20
12	L	M16X1.5	Z CKL 12 M 16X1.5	38,90
15	L	M18X1.5	Z CKL 15 M 18X1.5	52,20
18	L	M22X1.5	Z CKL 18 M 22X1.5	57,33
6	S	M12X1.5	Z CKS 6 M 12X1.5	24,15
8	S	M14X1.5	Z CKS 8 M 14X1.5	43,35
10	S	M16X1.5	Z CKS 10 M 16X1.5	44,84
12	S	M18X1.5	Z CKS 12 M 18X1.5	47,72
14	S	M20X1.5	Z CKS 14 M 20X1.5	46,99
16	S	M22X1.5	Z CKS 16 M 22X1.5	96,96

Racores DIN 2353

DIN 2353 Pipe fittings
Raccords à bague DIN 2353
Raccordi DIN 2353

Racor en T rosca cónica BSPT

Male stud branch TEE BSPT tapered

Raccord TÉ mâle gaz conique au centre

Raccordo di estremità a T BSP conico

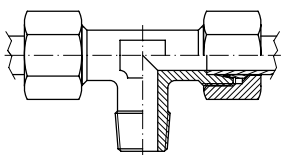

PIPE TUBO	SERIE	THREAD ROSCA	Part nº Referencia	€
6	L	1/8" BSPT	Z FKL 6 R 1/8	39,54
8	L	1/4" BSPT	Z FKL 8 R 1/4	36,14
10	L	1/4" BSPT	Z FKL 10 R 1/4	46,29
12	L	3/8" BSPT	Z FKL 12 R 3/8	52,22
15	L	1/2" BSPT	Z FKL 15 R 1/2	77,97
18	L	1/2" BSPT	Z FKL 18 R 1/2	90,41
6	S	1/4" BSPT	Z FKS 6 R 1/4	46,37
8	S	1/4" BSPT	Z FKS 8 R 1/4	52,34
10	S	3/8" BSPT	Z FKS 10 R 3/8	53,53
12	S	3/8" BSPT	Z FKS 12 R 3/8	68,83
14	S	1/2" BSPT	Z FKS 14 R 1/2	86,61
16	S	1/2" BSPT	Z FKS 16 R 1/2	101,45

Racor en T rosca cónica Métrica

Male stud branch TEE Metric tapered

Raccord TÉ mâle Métrique au centre

Raccordo di estremità a T Metrico conico

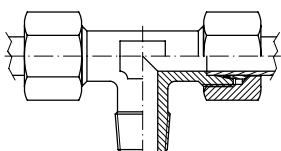

PIPE TUBO	SERIE	THREAD ROSCA	Part nº Referencia	€
6	L	M10X1	Z FKL 6 M 10X1	*
8	L	M12X1.5	Z FKL 8 M 12X1.5	*
10	L	M14X1.5	Z FKL 10 M 14X1.5	*
12	L	M16X1.5	Z FKL 12 M 16X1.5	*
15	L	M18X1.5	Z FKL 15 M 18X1.5	*
18	L	M22X1.5	Z FKL 18 M 22X1.5	*
6	S	M12X1.5	Z FKS 6 M 12X1.5	*
8	S	M14X1.5	Z FKS 8 M 14X1.5	*
10	S	M16X1.5	Z FKS 10 M 16X1.5	*
12	S	M18X1.5	Z FKS 12 M 18X1.5	*
14	S	M20X1.5	Z FKS 14 M 20X1.5	*
16	S	M22X1.5	Z FKS 16 M 22X1.5	*

Racor en L rosca cónica BSPT

Male stud barrel TEE BSPT tapered

Raccord TÉ mâle gaz conique latéral

Raccordo di estremità a L BSP conico

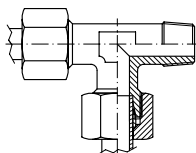

PIPE TUBO	SERIE	THREAD ROSCA	Part nº Referencia	€
6	L	1/8" BSPT	Z LKL 6 R 1/8	41,64
8	L	1/4" BSPT	Z LKL 8 R 1/4	44,02
10	L	1/4" BSPT	Z LKL 10 R 1/4	49,12
12	L	3/8" BSPT	Z LKL 12 R 3/8	51,97
15	L	1/2" BSPT	Z LKL 15 R 1/2	71,59
18	L	1/2" BSPT	Z LKL 18 R 1/2	120,24
6	S	1/4" BSPT	Z LKS 6 R 1/4	45,29
8	S	1/4" BSPT	Z LKS 8 R 1/4	50,12
10	S	3/8" BSPT	Z LKS 10 R 3/8	59,01
12	S	3/8" BSPT	Z LKS 12 R 3/8	62,91
14	S	1/2" BSPT	Z LKS 14 R 1/2	77,33
16	S	1/2" BSPT	Z LKS 16 R 1/2	97,55

Racor en T rosca cónica NPT

Male stud branch TEE NPT

Raccord TÉ mâle NPT au centre

Raccordo di estremità a T NPT

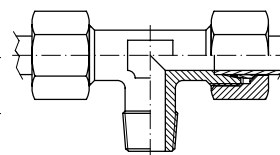

PIPE TUBO	SERIE	THREAD ROSCA	Part nº Referencia	€
6	L	1/8" NPT	Z FKL 6 R 1/8 NPT	43,31
8	L	1/4" NPT	Z FKL 8 R 1/4 NPT	41,87
10	L	1/4" NPT	Z FKL 10 R 1/4 NPT	51,90
12	L	3/8" NPT	Z FKL 12 R 3/8 NPT	60,62
18	L	1/2" NPT	Z FKL 18 R 1/2 NPT	114,21
22	L	3/4" NPT	Z FKL 22 R 3/4 NPT	145,14
28	L	1" NPT	Z FKL 28 R 1 NPT	192,72
35	L	1 1/4" NPT	Z FKL 35 R 1 1/4 NPT	368,79
42	L	1 1/2" NPT	Z FKL 42 R 1 1/2 NPT	380,69
6	S	1/4" NPT	Z FKS 6 R 1/4 NPT	47,63
10	S	3/8" NPT	Z FKS 10 R 3/8 NPT	54,72
12	S	3/8" NPT	Z FKS 12 R 3/8 NPT	68,05
14	S	1/2" NPT	Z FKS 14 R 1/2 NPT	71,76
16	S	1/2" NPT	Z FKS 16 R 1/2 NPT	111,83
20	S	3/4" NPT	Z FKS 20 R 3/4 NPT	142,76
25	S	1" NPT	Z FKS 25 R 1 NPT	207,00
30	S	1 1/4" NPT	Z FKS 30 R 1 1/4 NPT	333,10
38	S	1 1/2" NPT	Z FKS 38 R 1 1/2 NPT	511,55

Racor en L rosca cónica Métrica

Male stud barrel TEE Metric tapered

Raccord Té mâle Métrique latéral

Raccordo di estremità a L Metrico conico

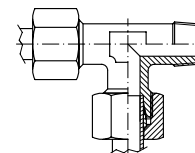

PIPE TUBO	SERIE	THREAD ROSCA	Part nº Referencia	€
6	L	M10X1	Z LKL 6 M 10X1	*
8	L	M12X1.5	Z LKL 8 M 12X1.5	*
10	L	M14X1.5	Z LKL 10 M 14X1.5	*
12	L	M16X1.5	Z LKL 12 M 16X1.5	*
15	L	M18X1.5	Z LKL 15 M 18X1.5	*
18	L	M22X1.5	Z LKL 18 M 22X1.5	*
6	S	M12X1.5	Z LKS 6 M 12X1.5	*
8	S	M14X1.5	Z LKS 8 M 14X1.5	*
10	S	M16X1.5	Z LKS 10 M 16X1.5	*
12	S	M18X1.5	Z LKS 12 M 18X1.5	*
14	S	M20X1.5	Z LKS 14 M 20X1.5	*
16	S	M22X1.5	Z LKS 16 M 22X1.5	*

Racores DIN 2353

DIN 2353 Pipe fittings
Raccords à bague DIN 2353
Raccordi DIN 2353

Crimping fittings for hoses

Pipe fittings

Pipe fittings II

Adaptors

Welding fittings

Industrial fittings

Accessories

Control components

Flow measuring

Tr/Me LOK

Racor de reducción con TL Métrica (serie ligera)

Standpipe reducer swivel female (light series)

Raccord union simple femelle tournante
Métrique (série légère)

Raccordo di riduzione con cono 24° (serie leggera)

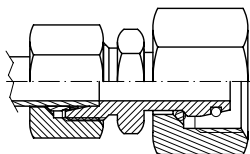

PIPE TUBO		SERIE	Part n° Referencia	€
8	6	L	Z KORL 8-6 TLM	27,36
10	6	L	Z KORL 10-6 TLM	25,37
12	6	L	Z KORL 12-6 TLM	30,53
12	8	L	Z KORL 12-8 TLM	26,37
12	10	L	Z KORL 12-10 TLM	27,36
15	6	L	Z KORL 15-6 TLM	34,69
15	8	L	Z KORL 15-8 TLM	32,83
15	10	L	Z KORL 15-10 TLM	35,57
15	12	L	Z KORL 15-12 TLM	27,38
18	8	L	Z KORL 18-8 TLM	38,20
18	10	L	Z KORL 18-10 TLM	39,40
18	12	L	Z KORL 18-12 TLM	34,68
18	15	L	Z KORL 18-15 TLM	38,81
22	10	L	Z KORL 22-10 TLM	39,70
22	12	L	Z KORL 22-12 TLM	39,32
22	15	L	Z KORL 22-15 TLM	45,77
22	18	L	Z KORL 22-18 TLM	47,24
28	10	L	Z KORL 28-10 TLM	59,38
28	12	L	Z KORL 28-12 TLM	55,07
28	15	L	Z KORL 28-15 TLM	62,73
28	18	L	Z KORL 28-18 TLM	57,61
28	22	L	Z KORL 28-22 TLM	58,75
35	12	L	Z KORL 35-12 TLM	87,45
35	22	L	Z KORL 35-22 TLM	96,97
35	28	L	Z KORL 35-28 TLM	90,55
42	22	L	Z KORL 42-22 TLM	120,28
42	28	L	Z KORL 42-28 TLM	124,66
42	35	L	Z KORL 42-35 TLM	130,13

Racor de reducción con TL Métrica (serie pesada)

Standpipe reducer swivel female (heavy series)

Raccord union simple femelle tournante
Métrique (série lourde)

Raccordo di riduzione con cono 24° (serie pesante)

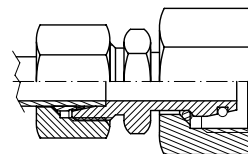

PIPE TUBO		SERIE	Part n° Referencia	€
8	6	S	Z KORS 8-6 TLM	28,90
10	6	S	Z KORS 10-6 TLM	30,98
10	8	S	Z KORS 10-8 TLM	32,28
12	6	S	Z KORS 12-6 TLM	32,72
12	8	S	Z KORS 12-8 TLM	32,72
12	10	S	Z KORS 12-10 TLM	36,12
14	10	S	Z KORS 14-10 TLM	37,09
14	12	S	Z KORS 14-12 TLM	37,87
16	6	S	Z KORS 16-6 TLM	41,73
16	8	S	Z KORS 16-8 TLM	39,29
16	10	S	Z KORS 16-10 TLM	39,62
16	12	S	Z KORS 16-12 TLM	37,20
16	14	S	Z KORS 16-14 TLM	43,67
20	8	S	Z KORS 20-8 TLM	51,33
20	10	S	Z KORS 20-10 TLM	51,23
20	12	S	Z KORS 20-12 TLM	50,78
20	14	S	Z KORS 20-14 TLM	52,74
20	16	S	Z KORS 20-16 TLM	51,64
25	12	S	Z KORS 25-12 TLM	65,98
25	16	S	Z KORS 25-16 TLM	71,69
25	20	S	Z KORS 25-20 TLM	79,79
30	16	S	Z KORS 30-16 TLM	113,71
30	20	S	Z KORS 30-20 TLM	114,81
30	25	S	Z KORS 30-25 TLM	121,38
38	20	S	Z KORS 38-20 TLM	145,45
38	25	S	Z KORS 38-25 TLM	156,40
38	30	S	Z KORS 38-30 TLM	166,25

Racores DIN 2353

DIN 2353 Pipe fittings
Raccords à bague DIN 2353
Raccordi DIN 2353

Reducción con rosca M-HF BSP con junta tórica

Male-female reducing adaptor BSP cylindrical with o'ring

Raccord réduction mâle gaz-fem gaz avec joint torique

Adattatore di riduzione filettato maschio - femmina BSP con guarnizione

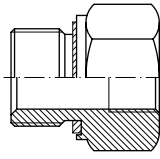

THREAD ROSCA		Part n° Referencia	€
M 1/8"BSP	F 1/4"BSP	Z RI-R 1/8 R 1/4WD	14,18
M 1/4"BSP	F 1/8"BSP	Z RI-R 1/4 R 1/8WD	14,38
M 1/4"BSP	F 3/8"BSP	Z RI-R 1/4 R 3/8WD	18,17
M 1/4"BSP	F 1/2"BSP	Z RI-R 1/4 R 1/2WD	20,90
M 3/8"BSP	F 1/8"BSP	Z RI-R 3/8 R 1/8WD	17,61
M 3/8"BSP	F 1/4"BSP	Z RI-R 3/8 R 1/4WD	16,75
M 3/8"BSP	F 1/2"BSP	Z RI-R 3/8 R 1/2WD	19,41
M 3/8"BSP	F 3/4"BSP	Z RI-R 3/8 R 3/4WD	27,85
M 1/2"BSP	F 1/8"BSP	Z RI-R 1/2 R 1/8WD	22,72
M 1/2"BSP	F 1/4"BSP	Z RI-R 1/2 R 1/4WD	18,17
M 1/2"BSP	F 3/8"BSP	Z RI-R 1/2 R 3/8WD	20,79
M 1/2"BSP	F 3/4"BSP	Z RI-R 1/2 R 3/4WD	30,01
M 3/4"BSP	F 3/8"BSP	Z RI-R 3/4 R 3/8WD	28,01
M 3/4"BSP	F 1/2"BSP	Z RI-R 3/4 R 1/2WD	28,09
M 3/4"BSP	F 1"BSP	Z RI-R 3/4 R 1WD	49,41
M 1"BSP	F 1/4"BSP	Z RI-R 1 R 1/4WD	34,62
M 1"BSP	F 3/8"BSP	Z RI-R 1 R 3/8WD	34,74
M 1"BSP	F 1/2"BSP	Z RI-R 1 R 1/2WD	34,28
M 1"BSP	F 3/4"BSP	Z RI-R 1 R 3/4WD	46,40
M 1"BSP	F 1"1/4 BSP	Z RI-R 1 R 1 1/4WD	104,91
M 1"1/4 BSP	F 1/2"BSP	Z RI-R 1 1/4 R 1/2WD	59,01
M 1"1/4 BSP	F 3/4"BSP	Z RI-R 1 1/4 R 3/4WD	59,92
M 1"1/4BSP	F 1"BSP	Z RI-R 1 1/4 R 1WD	84,70
M 1"1/4 BSP	F 1"1/2 BSP	Z RI-R 1 1/4 R 1 1/2WD	120,43
M 1"1/2 BSP	F 1/2"BSP	Z RI-R 1 1/2 R 1/2WD	82,09
M 1"1/2 BSP	F 3/4"BSP	Z RI-R 1 1/2 R 3/4WD	78,52
M 1"1/2 BSP	F 1"BSP	Z RI-R 1 1/2 R 1WD	74,95
M 1"1/2 BSP	F 1"1/4 BSP	Z RI-R 1 1/2 R 1 1/4WD	115,28
M 1"1/2 BSP	F 2" BSP	Z RI-R 1 1/2 R 2WD	138,91
M 2" BSP	F 1"1/2 BSP	Z RI-R 2 R 1 1/2WD	159,67

Racores DIN 2353

DIN 2353 Pipe fittings
Raccords à bague DIN 2353
Raccordi DIN 2353

Crimping fittings for hoses

Pipe fittings

Pipe fittings II

Adaptors

Welding fittings

Industrial fittings

Accessories

Control components

Flow measuring

Tri/Le LOK

Racor en codo regulable con tuerca y anillo

Adjustable stud elbow with nut and ring

Raccord coude orientable tube lisse équipé

Raccordo orientabile a 90° con dado e anello

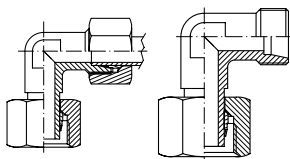

PIPE TUBO	SERIE	Part n° Referencia	€	Part N° STA Referencia STA	€
6	L	Z EEL 6 CTA	25,91	Z STA EEL 6 CTA	23,80
8	L	Z EEL 8 CTA	26,36	Z STA EEL 8 CTA	22,21
12	L	Z EEL 12 CTA	34,28	Z STA EEL 12 CTA	29,69
15	L	Z EEL 15 CTA	47,59	Z STA EEL 15 CTA	41,96
22	L	Z EEL 22 CTA	92,03	Z STA EEL 22 CTA	84,46
28	L	Z EEL 28 CTA	134,00	Z STA EEL 28 CTA	124,26
35	L	Z EEL 35 CTA	172,45	Z STA EEL 35 CTA	154,26
6	S	Z EES 6 CTA	24,49	Z STA EES 6 CTA	20,38
8	S	Z EES 8 CTA	27,74	Z STA EES 8 CTA	23,90
12	S	Z EES 12 CTA	39,24	Z STA EES 12 CTA	35,26
16	S	Z EES 16 CTA	56,32	Z STA EES 16 CTA	51,51

Hasta fin de existencias / Until end of stock / Jusqu'à la fin du stock / Fino ad esaurimento scorta

Racor en codo regulable TL Métrica

Adjustable stud elbow with o'ring

Raccord coude orientable Métrique avec o'ring

Raccordo orientabile a 90° con o'ring

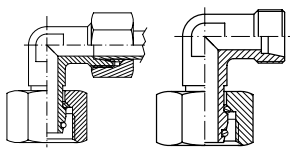

PIPE TUBO	SERIE	Part n° Referencia	€	Part N° STA Referencia STA	€
6	L	Z EEL 6 TLM	25,39	Z STA EEL 6 TLM	26,42
8	L	Z EEL 8 TLM	25,83	Z STA EEL 8 TLM	25,59
10	L	Z EEL 10 TLM	31,89	Z STA EEL 10 TLM	29,87
12	L	Z EEL 12 TLM	36,58	Z STA EEL 12 TLM	33,51
15	L	Z EEL 15 TLM	47,17	Z STA EEL 15 TLM	44,82
18	L	Z EEL 18 TLM	66,14	Z STA EEL 18 TLM	63,21
22	L	Z EEL 22 TLM	90,19	Z STA EEL 22 TLM	81,01
28	L	Z EEL 28 TLM	131,32	Z STA EEL 28 TLM	123,45
35	L	Z EEL 35 TLM	185,37	Z STA EEL 35 TLM	164,45
42	L	Z EEL 42 TLM	295,60	Z STA EEL 42 TLM	285,12
6	S	Z EES 6 TLM	35,19	Z STA EES 6 TLM	32,86
8	S	Z EES 8 TLM	31,67	Z STA EES 8 TLM	32,40
10	S	Z EES 10 TLM	39,05	Z STA EES 10 TLM	37,55
12	S	Z EES 12 TLM	43,76	Z STA EES 12 TLM	42,00
14	S	Z EES 14 TLM	52,89	Z STA EES 14 TLM	48,61
16	S	Z EES 16 TLM	62,48	Z STA EES 16 TLM	61,13
20	S	Z EES 20 TLM	96,74	Z STA EES 20 TLM	89,53
25	S	Z EES 25 TLM	159,04	Z STA EES 25 TLM	139,86
30	S	Z EES 30 TLM	198,09	Z STA EES 30 TLM	189,51
38	S	Z EES 38 TLM	296,66	Z STA EES 38 TLM	276,03

Racor en T regulable TL Métrica

Adjustable stud branch TEE with o'ring

Raccord TÉ orientable Métrique avec o'ring

Raccordo orientabile a T con o'ring

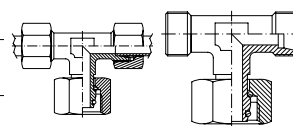

PIPE TUBO	SERIE	Part n° Referencia	€	Part N° STA Referencia STA	€
6	L	Z TEL 6 TLM	32,36	Z STA TEL 6 TLM	27,74
8	L	Z TEL 8 TLM	35,95	Z STA TEL 8 TLM	30,54
10	L	Z TEL 10 TLM	39,66	Z STA TEL 10 TLM	33,30
12	L	Z TEL 12 TLM	44,81	Z STA TEL 12 TLM	38,94
15	L	Z TEL 15 TLM	76,95	Z STA TEL 15 TLM	60,38
18	L	Z TEL 18 TLM	102,11	Z STA TEL 18 TLM	85,74
22	L	Z TEL 22 TLM	136,71	Z STA TEL 22 TLM	122,86
28	L	Z TEL 28 TLM	206,35	Z STA TEL 28 TLM	176,50
35	L	Z TEL 35 TLM	333,57	Z STA TEL 35 TLM	277,71
42	L	Z TEL 42 TLM	405,83	Z STA TEL 42 TLM	355,69
6	S	Z TES 6 TLM	39,67	Z STA TES 6 TLM	31,66
8	S	Z TES 8 TLM	43,98	Z STA TES 8 TLM	36,61
10	S	Z TES 10 TLM	48,46	Z STA TES 10 TLM	42,43
12	S	Z TES 12 TLM	59,57	Z STA TES 12 TLM	51,83
14	S	Z TES 14 TLM	96,65	Z STA TES 14 TLM	86,65
16	S	Z TES 16 TLM	102,70	Z STA TES 16 TLM	97,22
20	S	Z TES 20 TLM	134,50	Z STA TES 20 TLM	122,99
25	S	Z TES 25 TLM	207,40	Z STA TES 25 TLM	173,22
30	S	Z TES 30 TLM	297,71	Z STA TES 30 TLM	252,76
38	S	Z TES 38 TLM	457,01	Z STA TES 38 TLM	375,88

Racor en L regulable TL Métrica

Adjustable stud barrel TEE with o'ring

Raccord L orientable renversé Métrique avec o'ring

Raccordo orientabile a L con o'ring

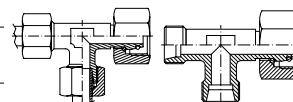

T.	S.	THREAD ROSCA	Part n° Referencia	€	Part N° STA Referencia STA	€
6	L	M12X1.5	Z LEL 6 TLM	31,83	Z STA LEL 6 TLM	26,46
8	L	M14X1.5	Z LEL 8 TLM	39,61	Z STA LEL 8 TLM	34,25
10	L	M16X1.5	Z LEL 10 TLM	45,93	Z STA LEL 10 TLM	39,00
12	L	M18X1.5	Z LEL 12 TLM	54,85	Z STA LEL 12 TLM	48,82
15	L	M22X1.5	Z LEL 15 TLM	79,45	Z STA LEL 15 TLM	68,19
18	L	M26X1.5	Z LEL 18 TLM	101,77	Z STA LEL 18 TLM	88,23
22	L	M30X2	Z LEL 22 TLM	144,27	Z STA LEL 22 TLM	130,00
28	L	M36X2	Z LEL 28 TLM	208,62	Z STA LEL 28 TLM	177,95
35	L	M45X2	Z LEL 35 TLM	348,45	Z STA LEL 35 TLM	291,49
42	L	M52X2	Z LEL 42 TLM	486,57	Z STA LEL 42 TLM	416,17
6	S	M14X1.5	Z LES 6 TLM	32,62	Z STA LES 6 TLM	25,07
8	S	M16X1.5	Z LES 8 TLM	41,95	Z STA LES 8 TLM	33,90
10	S	M18X1.5	Z LES 10 TLM	54,58	Z STA LES 10 TLM	48,20
12	S	M20X1.5	Z LES 12 TLM	56,20	Z STA LES 12 TLM	47,65
14	S	M22X1.5	Z LES 14 TLM	85,70	Z STA LES 14 TLM	71,36
16	S	M24X1.5	Z LES 16 TLM	97,55	Z STA LES 16 TLM	86,55
20	S	M30X2	Z LES 20 TLM	135,73	Z STA LES 20 TLM	117,78
25	S	M36X2	Z LES 25 TLM	219,44	Z STA LES 25 TLM	190,51
30	S	M42X2	Z LES 30 TLM	327,59	Z STA LES 30 TLM	277,03
38	S	M52X2	Z LES 38 TLM	451,96	Z STA LES 38 TLM	379,58

Racores DIN 2353

DIN 2353 Pipe fittings
Raccords à bague DIN 2353
Raccordi DIN 2353

Racor unión TL Métrica

Straight connection with o'ring

Raccord union tournante Métrique égale

Raccordo di estremità diritto Metrico con o'ring

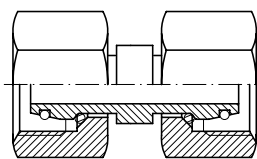

PIPE TUBO	SERIE	Part nº Referencia	€
6	L	Z ATL 6	27,20
8	L	Z ATL 8	28,51
10	L	Z ATL 10	27,21
12	L	Z ATL 12	33,08
15	L	Z ATL 15	45,95
18	L	Z ATL 18	59,80
22	L	Z ATL 22	64,00
28	L	Z ATL 28	98,36
35	L	Z ATL 35	146,48
42	L	Z ATL 42	195,73
6	S	Z ATS 6	37,73
8	S	Z ATS 8	32,95
10	S	Z ATS 10	32,28
12	S	Z ATS 12	42,18
14	S	Z ATS 14	49,96
16	S	Z ATS 16	53,71
20	S	Z ATS 20	67,39
25	S	Z ATS 25	96,05
30	S	Z ATS 30	154,53
38	S	Z ATS 38	207,73

Racor recto macho BSP con junta plana - TLM

Straight stud standpipe adaptor with captive seal BSP cylindrical-metric swivel fem.

Raccord adapt.tube lisse-mâle gaz BSP avec joint plat-fem.tourn.métrique

Adattatore diritto BSP cilindrico con guarnizione ed o'ring

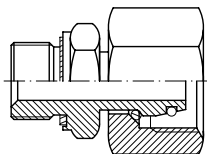

PIPE TUBO	SERIE	THREAD ROSCA	Part nº Referencia	€
6	L	1/8"BSP	Z RAL 6 R 1/8TLMWD	26,77
8	L	1/4"BSP	Z RAL 8 R 1/4TLMWD	28,64
10	L	1/4"BSP	Z RAL 10 R 1/4TLMWD	26,31
12	L	1/4"BSP	Z RAL 12 R 1/4TLMWD	26,98
12	L	3/8"BSP	Z RAL 12 R 3/8TLMWD	27,95
12	L	1/2"BSP	Z RAL 12 R 1/2TLMWD	30,14
15	L	1/2"BSP	Z RAL 15 R 1/2TLMWD	36,59
18	L	1/2"BSP	Z RAL 18 R 1/2TLMWD	48,99
22	L	3/4"BSP	Z RAL 22 R 3/4TLMWD	52,74
28	L	1"BSP	Z RAL 28 R 1TLMWD	90,73
35	L	1"1/4 BSP	Z RAL 35 R 1 1/4TLMWD	113,65
42	L	1"1/2 BSP	Z RAL 42 R 1 1/2TLMWD	158,15
6	S	1/4"BSP	Z RAS 6 R 1/4TLMWD	29,15
8	S	1/4"BSP	Z RAS 8 R 1/4TLMWD	26,31
10	S	3/8"BSP	Z RAS 10 R 3/8TLMWD	29,38
12	S	3/8"BSP	Z RAS 12 R 3/8TLMWD	29,46
14	S	1/2"BSP	Z RAS 14 R 1/2TLMWD	38,93
16	S	1/2"BSP	Z RAS 16 R 1/2TLMWD	51,58
20	S	3/4"BSP	Z RAS 20 R 3/4TLMWD	53,89
25	S	1"BSP	Z RAS 25 R 1TLMWD	96,29
30	S	1"1/4 BSP	Z RAS 30 R 1 1/4TLMWD	120,44
38	S	1"1/2 BSP	Z RAS 38 R 1 1/2TLMWD	150,76

Racor recto macho NPT - TL Metrica

Straight stud standpipe adaptor NPT- metric swivel fem.

Raccord adapteur tube lisse - mâle NPT- fem. tourn. métrique

Adattatore diritto NPT - tubo TLM

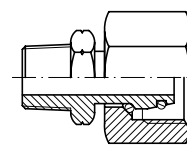

PIPE TUBO	SERIE	THREAD ROSCA	Part nº Referencia	€
6	L	1/8"NPT	Z RAL 6 R 1/8 NPTTLM	12,41
8	L	1/4"NPT	Z RAL 8 R 1/4 NPTTLM	27,38
10	L	1/4"NPT	Z RAL 10 R 1/4 NPTTLM	28,23
12	L	3/8" NPT	Z RAL 12 R 3/8 NPTTLM	39,47
15	L	1/2" NPT	Z RAL 15 R 1/2 NPTTLM	26,16
18	L	1/2"NPT	Z RAL 18 R 1/2 NPTTLM	59,51
22	L	3/4"NPT	Z RAL 22 R 3/4 NPTTLM	67,08
28	L	1"NPT	Z RAL 28 R 1 NPTTLM	80,46
35	L	1"1/4 NPT	Z RAL 35 R 1 1/4 NPTTLM	131,08
42	L	1"1/2 NPT	Z RAL 42 R 1 1/2 NPTTLM	145,31
6	S	1/4"NPT	Z RAS 6 R 1/4 NPTTLM	17,55
8	S	1/4"NPT	Z RAS 8 R 1/4 NPTTLM	18,02
10	S	3/8"NPT	Z RAS 10 R 3/8 NPTTLM	24,81
12	S	1/4" NPT	Z RAS 12 R 1/4 NPTTLM	24,72
14	S	1/2"NPT	Z RAS 14 R 1/2 NPTTLM	29,48
16	S	1/2"NPT	Z RAS 16 R 1/2 NPTTLM	57,31
20	S	3/4"NPT	Z RAS 20 R 3/4 NPTTLM	80,97
25	S	3/4"NPT	Z RAS 25 R 3/4 NPTTLM	106,57
25	S	1"NPT	Z RAS 25 R 1 NPTTLM	88,81
30	S	1"NPT	Z RAS 30 R 1 NPTTLM	116,31
30	S	1"1/4 NPT	Z RAS 30 R 1 1/4 NPTTLM	146,16
38	S	1"1/2 NPT	Z RAS 38 R 1 1/2 NPTTLM	155,04

Racor recto macho Métrico con junta plana - tubo TLM

Straight stud standpipe adaptor Metric with captive seal-metric swivel fem.

Raccord adapt.tube lisse-mâle Métrique avec joint plat-fem.tourn.métrique

Adattatore diritto Metrico cilindrico con guarnizione - tubo TLM

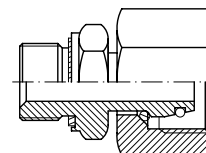

PIPE TUBO	SERIE	THREAD ROSCA	Part nº Referencia	€
6	L	M10X1	Z RAL 6M10X1TLMWD	28,93
8	L	M12X1.5	Z RAL 8M12X1.5TLMWD	25,58
10	L	M14X1.5	Z RAL 10M14X1.5TLMWD	32,48
12	L	M16X1.5	Z RAL 12M16X1.5TLMWD	31,31
15	L	M18X1.5	Z RAL 15M18X1.5TLMWD	39,26
18	L	M22X1.5	Z RAL 18M22X1.5TLMWD	50,44
22	L	M26X1.5	Z RAL 22M26X1.5TLMWD	58,17
28	L	M33X2	Z RAL 28M33X2TLMWD	92,67
35	L	M42X2	Z RAL 35M42X2TLMWD	142,94
42	L	M48X2	Z RAL 42M48X2TLMWD	161,79
6	S	M12X1.5	Z RAS 6M12X1.5TLMWD	29,15
8	S	M14X1.5	Z RAS 8M14X1.5TLMWD	28,79
10	S	M16X1.5	Z RAS 10M16X1.5TLMWD	30,34
12	S	M18X1.5	Z RAS 12M18X1.5TLMWD	33,24
14	S	M20X1.5	Z RAS 14M20X1.5TLMWD	45,50
16	S	M22X1.5	Z RAS 16M22X1.5TLMWD	49,85
20	S	M27X2	Z RAS 20M27X2TLMWD	67,69
25	S	M33X2	Z RAS 25M33X2TLMWD	100,09
30	S	M42X2	Z RAS 30M42X2TLMWD	137,88
38	S	M48X2	Z RAS 38M48X2TLMWD	178,59

Racores DIN 2353

DIN 2353 Pipe fittings
Raccords à bague DIN 2353
Raccordi DIN 2353

Crimping fittings for hoses

Pipe fittings

Pipe fittings II

Adaptors

Welding fittings

Industrial fittings

Accessories

Control components

Flow measuring

Tri/Me-LOK

Racor recto para soldar

Weldable straight coupling

Raccord mamelon hexagonal Métrique à souder

Raccordo diritto a saldare

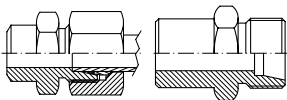

PIPE TUBO	SERIE	Part nº Referencia	€	Part Nº STA Referencia STA	€
6	L	Z ASL 6	11,01	Z STA ASL 6	7,27
8	L	Z ASL 8	12,62	Z STA ASL 8	8,67
10	L	Z ASL 10	13,85	Z STA ASL 10	9,29
12	L	Z ASL 12	14,73	Z STA ASL 12	10,82
15	L	Z ASL 15	24,13	Z STA ASL 15	16,10
18	L	Z ASL 18	27,66	Z STA ASL 18	19,73
22	L	Z ASL 22	34,20	Z STA ASL 22	25,62
28	L	Z ASL 28	59,47	Z STA ASL 28	36,44
35	L	Z ASL 35	80,42	Z STA ASL 35	47,87
42	L	Z ASL 42	105,00	Z STA ASL 42	72,57
6	S	Z ASS 6	13,68	Z STA ASS 6	9,05
8	S	Z ASS 8	17,25	Z STA ASS 8	11,99
10	S	Z ASS 10	19,18	Z STA ASS 10	13,83
12	S	Z ASS 12	24,38	Z STA ASS 12	17,13
14	S	Z ASS 14	31,88	Z STA ASS 14	21,23
16	S	Z ASS 16	27,91	Z STA ASS 16	20,91
20	S	Z ASS 20	38,24	Z STA ASS 20	25,71
25	S	Z ASS 25	57,92	Z STA ASS 25	33,44
30	S	Z ASS 30	76,11	Z STA ASS 30	47,56
38	S	Z ASS 38	133,24	Z STA ASS 38	87,96

Racor pasatabique para soldar

Weldable bulkhead coupling

Raccord union double passe cloison Métrique à souder

Raccordo passaparete a saldare

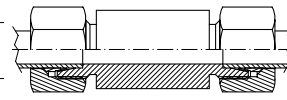

PIPE TUBO	SERIE	Part nº Referencia	€
6	L	Z ESVL 6	23,03
8	L	Z ESVL 8	26,44
10	L	Z ESVL 10	29,24
12	L	Z ESVL 12	32,61
15	L	Z ESVL 15	43,87
18	L	Z ESVL 18	57,37
22	L	Z ESVL 22	84,78
28	L	Z ESVL 28	105,73
35	L	Z ESVL 35	134,97
42	L	Z ESVL 42	200,21
6	S	Z ESVS 6	29,82
8	S	Z ESVS 8	33,28
10	S	Z ESVS 10	48,38
12	S	Z ESVS 12	45,78
14	S	Z ESVS 14	58,77
16	S	Z ESVS 16	67,46
20	S	Z ESVS 20	101,23
25	S	Z ESVS 25	126,59
30	S	Z ESVS 30	150,72
38	S	Z ESVS 38	232,60

Boquilla para soldar

Welding nipple with o-ring

Raccord collet cône métrique à souder

Ogiva a saldare con o'ring

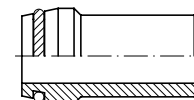

PIPE TUBO	SERIE	Part nº Referencia	€
15x2.5	L	Z ORIL 15	9,33
18x2.5	L	Z ORIL 18	13,73
22x2.5	L	Z ORIL 22	16,09
28x3	L	Z ORIL 28	22,34
35x4	L	Z ORIL 35	32,21
42x3	L	Z ORIL 42	52,91
6x2	L/S	Z ORIS 6	10,11
8x2	L/S	Z ORIS 8	8,71
10x2	L/S	Z ORIS 10	8,70
12x2	L/S	Z ORIS 12	8,88
14x3	S	Z ORIS 14	16,45
16x3	S	Z ORIS 16	12,69
20x3	S	Z ORIS 20	15,52
25x4	S	Z ORIS 25 *	22,44
30x5	S	Z ORIS 30	27,94
38x5	S	Z ORIS 38	37,89

* Podrà ser suministrada en 25x3 o 25x4 / * It could be delivered in 25x3 or 25x4 / * Livré en 25x3 ou 25x4 / * Potrà essere fornita in 25x3 o 25x4

Racores DIN 2353

DIN 2353 Pipe fittings
Raccords à bague DIN 2353
Raccordi DIN 2353

Racor recto pasatabique con tuerca

Straight bulkhead coupling

Raccord droit union double passe cloison avec écrou

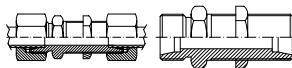

Raccordo passaparete

PIPE TUBO	SERIE	Part nº Referencia	€	Part nº STA Referencia STA	€
6	L	Z SVL 6	19,76	Z STA SVL 6	12,90
8	L	Z SVL 8	22,60	Z STA SVL 8	16,24
10	L	Z SVL 10	29,35	Z STA SVL 10	22,28
12	L	Z SVL 12	29,46	Z STA SVL 12	23,42
15	L	Z SVL 15	42,96	Z STA SVL 15	30,94
18	L	Z SVL 18	57,83	Z STA SVL 18	42,37
22	L	Z SVL 22	78,08	Z STA SVL 22	58,01
28	L	Z SVL 28	106,90	Z STA SVL 28	77,15
35	L	Z SVL 35	176,85	Z STA SVL 35	90,67
42	L	Z SVL 42	236,74	Z STA SVL 42	139,20
6	S	Z SVS 6	32,05	Z STA SVS 6	23,79
8	S	Z SVS 8	33,63	Z STA SVS 8	23,91
10	S	Z SVS 10	38,61	Z STA SVS 10	26,99
12	S	Z SVS 12	41,99	Z STA SVS 12	33,80
14	S	Z SVS 14	58,19	Z STA SVS 14	40,61
16	S	Z SVS 16	57,92	Z STA SVS 16	42,59
20	S	Z SVS 20	97,07	Z STA SVS 20	73,37
25	S	Z SVS 25	131,27	Z STA SVS 25	91,16
30	S	Z SVS 30	190,29	Z STA SVS 30	102,27
38	S	Z SVS 38	308,07	Z STA SVS 38	217,61

Racor en codo pasatabique con tuerca

Elbow bulkhead coupling

Raccord coude égal passe cloison

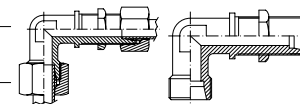

Raccordo passaparete a 90°

PIPE TUBO	SERIE	Part nº Referencia	€	Part nº STA Referencia STA	€
6	6	L Z USVL 6	48,72	Z STA USVL 6	43,51
8	19	L Z USVL 8	50,45	Z STA USVL 8	39,04
10	22	L Z USVL 10	48,72	Z STA USVL 10	35,58
12	24	L Z USVL 12	52,21	Z STA USVL 12	38,12
15	27	L Z USVL 15	82,54	Z STA USVL 15	71,12
18	32	L Z USVL 18	93,66	Z STA USVL 18	70,31
22	36	L Z USVL 22	140,90	Z STA USVL 22	105,45
28	42	L Z USVL 28	252,17		*
35	50	L Z USVL 35	452,07		*
42	60	L Z USVL 42	582,93		*
6	19	S Z USVS 6	55,68		*
8	22	S Z USVS 8	57,61	Z STA USVS 8	51,74
10	24	S Z USVS 10	60,76	Z STA USVS 10	46,82
12	27	S Z USVS 12	67,64	Z STA USVS 12	52,37
14	27	S Z USVS 14	89,82	Z STA USVS 14	69,09
16	30	S Z USVS 16	99,62	Z STA USVS 16	72,52
20	36	S Z USVS 20	158,82	Z STA USVS 20	126,00
25	42	S Z USVS 25	272,98		*
30	50	S Z USVS 30	388,30		*
38	60	S Z USVS 38	588,88		*

Tuerca pasatabique Métrica

Metric nut bulkhead

Écrou Métrique passe cloison



Dado passaparete Metrico

PIPE TUBO	THREAD ROSCA	Part nº Referencia	€
6L	M12x1.5	KZTPM12	2,11
8L / 6S	M14x1.5	KZTPM14	2,34
10L / 8S	M16x1.5	KZTPM16	3,01
12L / 10S	M18x1.5	KZTPM18	3,79
12S	M20x1.5	KZTPM20	4,67
15L / 14S	M22x1.5	KZTPM22	6,01
16S	M24x1.5	KZTPM24	7,24
18L	M26x1.5	KZTPM26	10,59
22L / 20S	M30x2	KZTPM30	13,80
28L / 25S	M36x2	KZTPM36	20,36
30S	M42x2	KZTPM42	26,54
35L	M45x2	KZTPM45	26,96
42L / 38S	M52x2	KZTPM52	37,02

Racores DIN 2353

DIN 2353 Pipe fittings
Raccords à bague DIN 2353
Raccordi DIN 2353

Racor recto hembra rosca BSP

Female stud coupling

Raccord union simple femelle gaz

Raccordo diritto femmina BSP

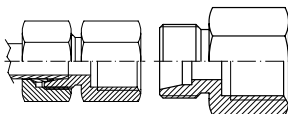

T.	S.	THREAD ROSCA	Part nº Referencia	€	Part Nº STA Referencia STA	€
6	L	1/8" BSP	Z GAIL 6 R 1/8	14,13	Z STA GAIL 6 R 1/8	11,64
6	L	1/4" BSP	Z GAIL 6 R 1/4	14,89	Z STA GAIL 6 R 1/4	12,93
8	L	1/4" BSP	Z GAIL 8 R 1/4	17,77	Z STA GAIL 8 R 1/4	14,52
10	L	1/4" BSP	Z GAIL 10 R 1/4	16,82	Z STA GAIL 10 R 1/4	13,77
12	L	1/2" BSP	Z GAIL 12 R 1/2	23,93	Z STA GAIL 12 R 1/2	19,60
12	L	3/8" BSP	Z GAIL 12 R 3/8	24,04	Z STA GAIL 12 R 3/8	20,09
15	L	1/2" BSP	Z GAIL 15 R 1/2	26,37	Z STA GAIL 15 R 1/2	21,44
18	L	1/2" BSP	Z GAIL 18 R 1/2	32,37	Z STA GAIL 18 R 1/2	23,96
22	L	3/4" BSP	Z GAIL 22 R 3/4	43,59	Z STA GAIL 22 R 3/4	31,62
28	L	1" BSP	Z GAIL 28 R 1	65,49	Z STA GAIL 28 R 1	37,69
35	L	1 1/4" BSP	Z GAIL 35 R 1 1/4	139,19	Z STA GAIL 35 R 1 1/4	90,08
42	L	1 1/2" BSP	Z GAIL 42 R 1 1/2	155,05	Z STA GAIL 42 R 1 1/2	106,24
6	S	1/4" BSP	Z GAIS 6 R 1/4	20,13	Z STA GAIS 6 R 1/4	15,74
8	S	1/4" BSP	Z GAIS 8 R 1/4	19,68	Z STA GAIS 8 R 1/4	15,43
10	S	3/8" BSP	Z GAIS 10 R 3/8	23,50	Z STA GAIS 10 R 3/8	18,68
12	S	3/8" BSP	Z GAIS 12 R 3/8	27,34	Z STA GAIS 12 R 3/8	22,32
14	S	3/8" BSP	Z GAIS 14 R 3/8 *	37,34		*
14	S	1/2" BSP	Z GAIS 14 R 1/2	36,56	Z STA GAIS 14 R 1/2	28,11
16	S	1/2" BSP	Z GAIS 16 R 1/2	34,00	Z STA GAIS 16 R 1/2	23,49
20	S	3/4" BSP	Z GAIS 20 R 3/4	56,73	Z STA GAIS 20 R 3/4	40,27
25	S	1" BSP	Z GAIS 25 R 1	77,42	Z STA GAIS 25 R 1	48,14
30	S	1 1/4" BSP	Z GAIS 30 R 1 1/4	123,72	Z STA GAIS 30 R 1 1/4	79,66
38	S	1 1/2" BSP	Z GAIS 38 R 1 1/2	151,68	Z STA GAIS 38 R 1 1/2	109,59

Hasta fin de existencias / Until end of stock / Jusqu'à la fin du stock / Fino ad esaurimento scorta

Racor para manómetro BSP

Gauge coupling BSP cylindrical

Raccord union pour manomètre gaz

Raccordo per manometro BSP

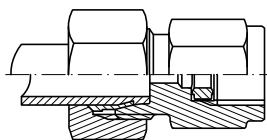

PIPE TUBO	SERIE	THREAD ROSCA	Part nº Referencia	€
6	L	1/4" BSP	Z MAVL 6 R 1/4	20,47
8	L	1/4" BSP	Z MAVL 8 R 1/4	20,47
10	L	1/4" BSP	Z MAVL 10 R 1/4	24,43
12	L	1/4" BSP	Z MAVL 12 R 1/4	24,43
6	S	1/2" BSP	Z MAVS 6 R 1/2	31,44
8	S	1/2" BSP	Z MAVS 8 R 1/2	30,52
10	S	1/2" BSP	Z MAVS 10 R 1/2	36,13
12	S	1/2" BSP	Z MAVS 12 R 1/2	31,44

Racor recto hembra rosca Métrica

Female stud coupling Metric Cylindrical

Raccord union simple femelle Métrique

Raccordo diritto femmina Metrico

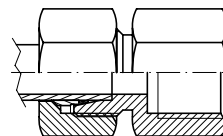

PIPE TUBO	SERIE	THREAD ROSCA	Part nº Referencia	€
6	L	M10X1	Z GAIL 6 M 10X1	17,44
8	L	M12X1.5	Z GAIL 8 M 12X1.5	20,82
10	L	M14X1.5	Z GAIL 10 M 14X1.5	24,00
12	L	M16X1.5	Z GAIL 12 M 16X1.5	28,64
15	L	M18X1.5	Z GAIL 15 M 18X1.5	39,02
18	L	M22X1.5	Z GAIL 18 M 22X1.5	46,40
22	L	M26X1.5	Z GAIL 22 M 26X1.5	51,04
28	L	M33X2	Z GAIL 28 M 33X2	77,33
35	L	M42X2	Z GAIL 35 M 42X2	140,38
42	L	M48X2	Z GAIL 42 M 48X2	186,55
6	S	M12X1.5	Z GAIS 6 M 12X1.5	23,79
8	S	M14X1.5	Z GAIS 8 M 14X1.5	28,79
10	S	M16X1.5	Z GAIS 10 M 16X1.5	27,72
12	S	M18X1.5	Z GAIS 12 M 18X1.5	34,50
14	S	M20X1.5	Z GAIS 14 M 20X1.5	44,54
16	S	M22X1.5	Z GAIS 16 M 22X1.5	46,40
20	S	M27X2	Z GAIS 20 M 27X2	65,91
25	S	M33X2	Z GAIS 25 M 33X2	94,58
30	S	M42X2	Z GAIS 30 M 42X2	181,23
38	S	M48X2	Z GAIS 38 M 48X2	246,06

Arandela para manómetros

Seal for gauge coupling

Raccord bague pour manomètres

Guarnizione per manometro

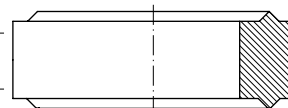

THREAD ROSCA	Part nº Referencia	€
R 1/4" BSP	Z AM 6	5,10
R 1/2" BSP	Z AM 12	6,54

Racores DIN 2353

DIN 2353 Pipe fittings
Raccords à bague DIN 2353
Raccordi DIN 2353

Racor en codo orientable sin estrangulación rosca BSP

Banjo coupling with captive seal and o'ring BSP cylindrical

Raccord équerre orientable articulée sans étranglement gaz

Raccordo orientabile 90° ad occhio BSP con guarnizione

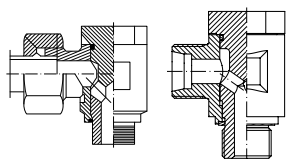

T.	S.	THREAD ROSCA	Part nº Referencia	€	Part Nº STA Referencia STA	€
6	L	1/8" BSP	Z WSVL 6 R 1/8	75,92	Z STA WSVL 6 R 1/8	*
6	L	1/4" BSP	Z WSVL 6 R 1/4	76,00	Z STA WSVL 6 R 1/4	71,75
8	L	1/4" BSP	Z WSVL 8 R 1/4	79,81	Z STA WSVL 8 R 1/4	76,61
10	L	1/4" BSP	Z WSVL 10 R 1/4	76,01	Z STA WSVL 10 R 1/4	72,81
12	L	3/8" BSP	Z WSVL 12 R 3/8	91,29	Z STA WSVL 12 R 3/8	87,60
15	L	1/2" BSP	Z WSVL 15 R 1/2	125,56	Z STA WSVL 15 R 1/2	120,53
18	L	1/2" BSP	Z WSVL 18 R 1/2	161,58	Z STA WSVL 18 R 1/2	153,94
22	L	3/4" BSP	Z WSVL 22 R 3/4	256,97	Z STA WSVL 22 R 3/4	248,57
28	L	1" BSP	Z WSVL 28 R 1	*	Z STA WSVL 28 R 1	*
35	L	1 1/4" BSP	Z WSVL 35 R 1 1/4	*	Z STA WSVL 35 R 1 1/4	*
42	L	1 1/2" BSP	Z WSVL 42 R 1 1/2	*	Z STA WSVL 42 R 1 1/2	*
6	S	1/4" BSP	Z WSVS 6 R 1/4	81,77	Z STA WSVS 6 R 1/4	77,57
8	S	1/4" BSP	Z WSVS 8 R 1/4	89,55	Z STA WSVS 8 R 1/4	84,98
10	S	3/8" BSP	Z WSVS 10 R 3/8	101,23	Z STA WSVS 10 R 3/8	97,16
12	S	3/8" BSP	Z WSVS 12 R 3/8	113,89	Z STA WSVS 12 R 3/8	109,65
14	S	1/2" BSP	Z WSVS 14 R 1/2	133,35	Z STA WSVS 14 R 1/2	127,09
16	S	1/2" BSP	Z WSVS 16 R 1/2	167,32	Z STA WSVS 16 R 1/2	160,81
20	S	3/4" BSP	Z WSVS 20 R 3/4	253,94	Z STA WSVS 20 R 3/4	246,74
25	S	1" BSP	Z WSVS 25 R 1	*	Z STA WSVS 25 R 1	*
30	S	1 1/4" BSP	Z WSVS 30 R 1 1/4	*	Z STA WSVS 30 R 1 1/4	*
38	S	1 1/2" BSP	Z WSVS 38 R 1 1/2	*	Z STA WSVS 38 R 1 1/2	*

Racor en codo orientable sin estrangulación rosca Métrica

Banjo coupling with captive seal and o'ring Metric cylindrical

Raccord équerre orientable articulée sans étranglement Métrique

Raccordo orientabile 90° ad occhio Metrico con guarnizione

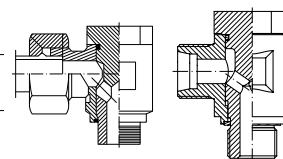

T.	S.	THREAD ROSCA	Part nº Referencia	€	Part Nº STA Referencia STA	€
6	L	M10X1	Z WSVL 6 M 10X1	79,81	Z STA WSVL 6 M 10X1	77,07
8	L	M12X1.5	Z WSVL 8 M 12X1,5	83,71	Z STA WSVL 8 M 12X1,5	80,75
10	L	M14X1.5	Z WSVL 10 M 14X1,5	90,52	Z STA WSVL 10 M 14X1,5	87,03
12	L	M16X1.5	Z WSVL 12 M 16X1,5	97,34	Z STA WSVL 12 M 16X1,5	93,73
15	L	M18X1.5	Z WSVL 15 M 18X1,5	130,43	Z STA WSVL 15 M 18X1,5	125,25
18	L	M22X1.5	Z WSVL 18 M 22X1,5	159,63	Z STA WSVL 18 M 22X1,5	152,72
22	L	M26X1.5	Z WSVL 22 M 26X1,5	*	Z STA WSVL 22 M 26X1,5	*
28	L	M33X2	Z WSVL 28 M 33X2	*	Z STA WSVL 28 M 33X2	*
35	L	M42X2	Z WSVL 35 M 42X2	*	Z STA WSVL 35 M 42X2	*
42	L	M48X2	Z WSVL 42 M 48X2	*	Z STA WSVL 42 M 48X2	*
6	S	M12X1.5	Z WSVS 6 M 12X1,5	85,65	Z STA WSVS 6 M 12X1,5	81,26
8	S	M14X1.5	Z WSVS 8 M 14X1,5	91,49	Z STA WSVS 8 M 14X1,5	86,92
10	S	M16X1.5	Z WSVS 10 M 16X1,5	107,07	Z STA WSVS 10 M 16X1,5	103,07
12	S	M18X1.5	Z WSVS 12 M 18X1,5	118,75	Z STA WSVS 12 M 18X1,5	114,05
14	S	M20X1.5	Z WSVS 14 M 20X1,5	138,21	Z STA WSVS 14 M 20X1,5	127,56
16	S	M22X1.5	Z WSVS 16 M 22X1,5	177,15	Z STA WSVS 16 M 22X1,5	170,55
20	S	M27X2	Z WSVS 20 M 27X2	257,94	Z STA WSVS 20 M 27X2	247,93
30	S	M42X2	Z WSVS 30 M 42X2	*	Z STA WSVS 30 M 42X2	*
38	S	M48X2	Z WSVS 38 M 48X2	*	Z STA WSVS 38 M 48X2	*

Racores DIN 2353

DIN 2353 Pipe fittings
Raccords à bague DIN 2353
Raccordi DIN 2353

Crimping fittings for hoses

Pipe fittings

Pipe fittings II

Adaptors

Welding fittings

Industrial fittings

Accessories

Control components

Flow measuring

Tri/Le LOK

Tapón de cierre para tubo con junta tórica

Blanking plug with o'ring

Raccord bouchon de fermeture avec o'ring

Tappo di chiusura con o'ring

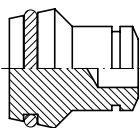

PIPE TUBO	SERIE	Part n° Referencia	€
6	L/S	Z BUTZEN L 6	6,18
8	L/S	Z BUTZEN L 8	5,60
10	L/S	Z BUTZEN L 10	5,78
12	L/S	Z BUTZEN L 12	6,91
15	L	Z BUTZEN L 15	7,71
18	L	Z BUTZEN L 18	9,95
22	L	Z BUTZEN L 22	13,70
28	L	Z BUTZEN L 28	20,89
35	L	Z BUTZEN L 35	35,82
42	L	Z BUTZEN L 42	49,26
14	S	Z BUTZEN S 14	10,45
16	S	Z BUTZEN S 16	9,83
20	S	Z BUTZEN S 20	21,89
25	S	Z BUTZEN S 25	17,42
30	S	Z BUTZEN S 30	28,76
38	S	Z BUTZEN S 38	47,17

Tapón de cierre Allen rosca BSP con junta

Blanking plug with captive seal BSP cylindrical

Raccord bouchon Allen gaz avec joint plat

Tappo cilindrico BSP esagono incassato con guarnizione

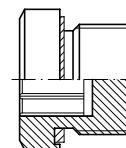

THREAD ROSCA	Part n° Referencia	€
1/8" BSP	Z STOPFEN 1/8	6,42
1/4" BSP	Z STOPFEN 1/4	7,12
3/8" BSP	Z STOPFEN 3/8	8,24
1/2" BSP	Z STOPFEN 1/2	10,65
3/4" BSP	Z STOPFEN 3/4	15,01
1" BSP	Z STOPFEN 1	23,44
1"1/4 BSP	Z STOPFEN 1 1/4	42,79
1"1/2 BSP	Z STOPFEN 1 1/2	48,15

Tapón de cierre Allen rosca Métrica con junta

Blanking plug with captive seal Metric cylindrical

Raccord bouchon Allen Métrique avec joint plat

Tappo cilindrico Metrico esagono incassato con guarnizione

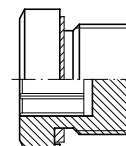

PIPE TUBO	THREAD ROSCA	Part n° Referencia	€
14	M10X1	Z STOPFEN M 10X1	7,18
17	M12X1.5	Z STOPFEN M 12X1,5	8,03
19	M14X1.5	Z STOPFEN M 14X1,5	7,69
22	M16X1.5	Z STOPFEN M 16X1,5	9,05
24	M18X1.5	Z STOPFEN M 18X1,5	10,26
26	M20X1.5	Z STOPFEN M 20X1,5	16,26
27	M22X1.5	Z STOPFEN M 22X1,5	18,45
32	M26X1.5	Z STOPFEN M 26X1,5	29,88
32	M27X2	Z STOPFEN M 27X2	26,76
40	M33X2	Z STOPFEN M 33X2	36,75
50	M42X2	Z STOPFEN M 42X2	43,67
55	M48X2	Z STOPFEN M 48X2	76,62

Juntas tóricas FKM verde

Green FKM o-ring

Joint torique en FKM vert

Guarnizioni o'Rings FKM verde

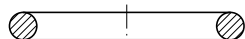

PIPE TUBO	Part n° Referencia	€
6	JVT06	0,80
8	JVT08	0,86
10	JVT10	0,94
12	JVT12	0,98
14	JVT14	1,07
15-16	JVT15	1,05
18	JVT18	1,24
20	JVT20	1,24
22	JVT22	1,33
25	JVT25	1,38
28	JVT28	1,44
30	JVT30	1,54
35	JVT35	2,13
38	JVT38	2,20
42	JVT42	2,40

Juntas planas FKM verde

Green FKM captive seal

Joint plat en FKM vert

Guarnizioni piatte FKM verde

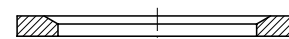

THREAD ROSCA	Part n° Referencia	€
1/8" BSP - M10x1	JVBSP02	3,07
M12x1.5	JVM12	3,07
1/4" BSP - M14x1.5	JVBSP04	3,01
M16x1.5	JVM16	3,07
3/8" BSP	JVBSP06	3,07
M18x1.5	JVM18	3,20
M20x1.5	JVM20	3,20
1/2" BSP	JVBSP08	3,21
M22x1.5	JVM22	3,28
3/4" BSP - M26x1.5	JVBSP12	3,27
1" BSP - M33x2	JVBSP16	3,41
1"1/4 BSP - M42x2	JVBSP20	5,21
1"1/2 BSP - M48x2	JVBSP24	5,61
2" BSP	JVBSP32	17,16

Racores DIN 2353

DIN 2353 Pipe fittings
Raccords à bague DIN 2353
Raccordi DIN 2353

Vomo

Tool

Outil

Attrezzo

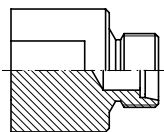

PIPE TUBO	SERIE	THREAD ROSCA	Part n° Referencia	€
6	L	12x1.5	Z VOMO L 6	*
8	L	14x1.5	Z VOMO L 8	*
10	L	16x1.5	Z VOMO L 10	*
12	L	18x1.5	Z VOMO L 12	*
15	L	22x1.5	Z VOMO L 15	*
18	L	26x1.5	Z VOMO L 18	*
22	L	30x2.0	Z VOMO L 22	*
28	L	36x2.0	Z VOMO L 28	*
35	L	45x2.0	Z VOMO L 35	*
42	L	52x2.0	Z VOMO L 42	*
6	S	14x1.5	Z VOMO S 6	*
8	S	16x1.5	Z VOMO S 8	*
10	S	18x1.5	Z VOMO S 10	*
12	S	20x1.5	Z VOMO S 12	*
14	S	22x1.5	Z VOMO S 14	*
16	S	24x1.5	Z VOMO S 16	*
20	S	30x2.0	Z VOMO S 20	*
25	S	36x2.0	Z VOMO S 25	*
30	S	42x2.0	Z VOMO S 30	*
38	S	52x2.0	Z VOMO S 38	*

Material Acero Templado / Made of Hardened tool-steel / Matériel Acier Trempé / Materiale acciaio temprato

Grasa

Grease

Graisse

Lubrificante



DESCRIPTION DESCRIPCIÓN	Part n° Referencia	€
Grease	GR ASW120	62,75

Racores DIN 2353

DIN 2353 Pipe fittings
Raccords à bague DIN 2353
Raccordi DIN 2353

Crimping fittings for hoses

Pipe fittings

Pipe fittings II

Adaptors

Welding fittings

Industrial fittings

Accessories

Control components

Flow measuring

Tri/Le LOK

Válvula antirretorno rosca BSP-tubo

Non-return valve flow from male stud end BSP cylindrical

Clapet anti-rétour unidirectionnel à gauche mâle-tube

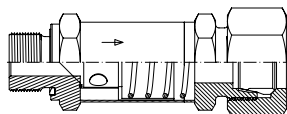

Valvola di ritegno a sinistra

PIPE TUBO	SERIE	THREAD ROSCA	Part nº Referencia	€
6	L	M 1/8" BSP	Z RHVL 6 R 1/8	*
8	L	M 1/4" BSP	Z RHVL 8 R 1/4	*
10	L	M 1/4" BSP	Z RHVL 10 R 1/4	*
12	L	M 3/8" BSP	Z RHVL 12 R 3/8	*
15	L	M 1/2" BSP	Z RHVL 15 R 1/2	*
18	L	M 1/2" BSP	Z RHVL 18 R 1/2	*
22	L	M 3/4" BSP	Z RHVL 22 R 3/4	*
28	L	M 1" BSP	Z RHVL 28 R 1	*
35	L	M 1 1/4" BSP	Z RHVL 35 R 1 1/4	*
42	L	M 1 1/2" BSP	Z RHVL 42 R 1 1/2	*
6	S	M 1/4" BSP	Z RHVS 6 R 1/4	*
8	S	M 1/4" BSP	Z RHVS 8 R 1/4	*
10	S	M 3/8" BSP	Z RHVS 10 R 3/8	*
12	S	M 3/8" BSP	Z RHVS 12 R 3/8	*
14	S	M 1/2" BSP	Z RHVS 14 R 1/2	*
16	S	M 1/2" BSP	Z RHVS 16 R 1/2	*
20	S	M 3/4" BSP	Z RHVS 20 R 3/4	*
25	S	M 1" BSP	Z RHVS 25 R 1	*
30	S	M 1 1/4" BSP	Z RHVS 30 R 1 1/4	*
38	S	M 1 1/2" BSP	Z RHVS 38 R 1 1/2	*

Taraje 1 bar. Para otras presiones de tarado estandard, consultar. / Setting 1 bar. For other standard spring pressures, consult us. / Tarage 1 bar. Pour d'autres pressions ressort standard, consultez-nous. / Per altre pressioni di taratura standard, consultare.

Válvula antirretorno tubo-tubo

Non-return valve tube-tube

Clapet anti-rétour bidirectionnel tube-tube

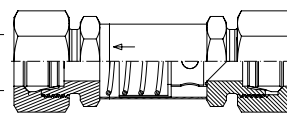

Valvola di ritegno tubo-tubo

PIPE TUBO	SERIE	Part nº Referencia	€
6	L	Z RHDL 6	38,46
8	L	Z RHDL 8	54,26
10	L	Z RHDL 10	48,37
12	L	Z RHDL 12	57,69
15	L	Z RHDL 15	67,44
18	L	Z RHDL 18	94,87
22	L	Z RHDL 22	127,44
28	L	Z RHDL 28	219,22
35	L	Z RHDL 35	*
42	L	Z RHDL 42	*
6	S	Z RHDS 6	38,73
8	S	Z RHDS 8	41,11
10	S	Z RHDS 10	50,25
12	S	Z RHDS 12	58,58
14	S	Z RHDS 14	73,48
16	S	Z RHDS 16	86,12
20	S	Z RHDS 20	113,88
25	S	Z RHDS 25	184,84
30	S	Z RHDS 30	300,86
38	S	Z RHDS 38	*

Taraje 1 bar. Para otras presiones de tarado estandard, consultar. / Setting 1 bar. For other standard spring pressures, consult us. / Tarage 1 bar. Pour d'autres pressions ressort standard, consultez-nous. / Per altre pressioni di taratura standard, consultare.

Válvula antirretorno tubo-rosca BSP

Non-return valve flow towards male stud end BSP cylindrical

Clapet anti-rétour unidirectionnel à droite tube-mâle

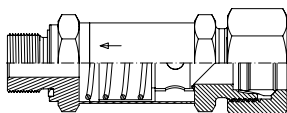

Valvola di ritegno a destra

PIPE TUBO	SERIE	THREAD ROSCA	Part nº Referencia	€
6	L	M 1/8" BSP	Z RHZL 6 R 1/8	*
8	L	M 1/4" BSP	Z RHZL 8 R 1/4	*
10	L	M 1/4" BSP	Z RHZL 10 R 1/4	*
12	L	M 3/8" BSP	Z RHZL 12 R 3/8	*
15	L	M 1/2" BSP	Z RHZL 15 R 1/2	*
18	L	M 1/2" BSP	Z RHZL 18 R 1/2	*
22	L	M 3/4" BSP	Z RHZL 22 R 3/4	*
28	L	M 1" BSP	Z RHZL 28 R 1	*
35	L	M 1 1/4" BSP	Z RHZL 35 R 1 1/4	*
42	L	M 1 1/2" BSP	Z RHZL 42 R 1 1/2	*
6	S	M 1/4" BSP	Z RHZS 6 R 1/4	*
8	S	M 1/4" BSP	Z RHZS 8 R 1/4	*
10	S	M 3/8" BSP	Z RHZS 10 R 3/8	*
12	S	M 3/8" BSP	Z RHZS 12 R 3/8	*
14	S	M 1/2" BSP	Z RHZS 14 R 1/2	*
16	S	M 1/2" BSP	Z RHZS 16 R 1/2	*
20	S	M 3/4" BSP	Z RHZS 20 R 3/4	*
25	S	M 1" BSP	Z RHZS 25 R 1	*
30	S	M 1 1/4" BSP	Z RHZS 30 R 1 1/4	*
38	S	M 1 1/2" BSP	Z RHZS 38 R 1 1/2	*

Taraje 1 bar. Para otras presiones de tarado estandard, consultar. / Setting 1 bar. For other standard spring pressures, consult us. / Tarage 1 bar. Pour d'autres pressions ressort standard, consultez-nous. / Per altre pressioni di taratura standard, consultare.

Racores JIC 37°

Flare fittings JIC 37°

Adaptateurs JIC 37°

Raccordi JIC 37°

Tuercas JIC 37°

Nut JIC 37°

Écrou JIC 37°

Dado JIC

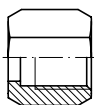

PIPE TUBO	THREAD ROSCA	Part nº Referencia	€	
6	1/4	7/16" 20h UNF	ZS11006	4,79
8	5/16	1/2" 20h UNF	ZS11008	4,53
10	3/8	9/16" 18h UNF	ZS11010	5,05
12	1/2	3/4" 16h UNF	ZS11012	5,16
14-15-16	5/8	7/8" 14h UNF	ZS11016	6,54
18-20	-	1"1/16 12h UN	ZS11020	10,02
-	3/4	1"1/16 12h UNF	ZS11020W	18,68
25	1	1"5/16 12h UN	ZS11025	19,57
30-32	1 1/4	1"5/8 12h UN	ZS11032	26,64
38	1 1/2	1"7/8 12h UN	ZS11038	49,32

Ferulas JIC 37° (tubo Métrico)

Metric tube sleeves JIC 37°

Ferrules JIC 37° pour tube Métrique

Bussola JIC 37° per tubo Metrico

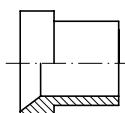

PIPE TUBO	Part nº Referencia	€
6	ZS12006	2,75
8	ZS12008	2,97
10	ZS12010	3,65
12	ZS12012	3,75
14	ZS12014	6,33
15	ZS12015	6,33
16	ZS12016	6,09
18	ZS12018	7,73
20	ZS12020	7,43
25	ZS12025	11,71
30	ZS12030	15,12
32	ZS12032	16,46
38	ZS12038	25,72

Ferulas JIC 37° (tubo Gas)

Tube sleeves Gas JIC 37°

Ferrules JIC 37° pour tube Gaz

Bussola JIC 37° per tubo gas

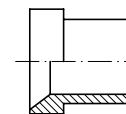

PIPE TUBO	Part nº Referencia	€
1/4"	ZS12104	3,52
5/16"	ZS12105	3,87
3/8"	ZS12106	4,58
1/2"	ZS12108	5,06
5/8"	ZS12110	5,41
3/4"	ZS12112	7,73
1"	ZS12116	18,11
1"1/4	ZS12120	22,99
1"1/2	ZS12124	32,35
2"	ZS12132	44,79

Tapón macho JIC 37°

Plug male JIC 37°

Bouchon mâle JIC 37°

Tappo maschio JIC 37°

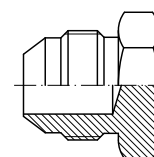

PIPE TUBO	THREAD ROSCA	Part nº Referencia	€	
6	1/4	7/16" 20h UNF	ZS14006	7,55
8	5/16	1/2" 20h UNF	ZS14008	7,62
10	3/8	9/16" 18h UNF	ZS14010	10,79
12	1/2	3/4" 16h UNF	ZS14012	13,18
14-15-16	5/8	7/8" 14h UNF	ZS14016	15,35
18-20	3/4	1"1/16 12h UN	ZS14020	20,40
25	1	1"5/16 12h UN	ZS14025	27,07
30-32	1 1/4	1"5/8 12h UN	ZS14032	46,38
38	1 1/2	1"7/8 12h UN	ZS14038	69,14

Tapón hembra giratoria JIC 37°

Plug female JIC 37°

Bouchon femelle JIC 37°

Tappo femmina girevole JIC 37°

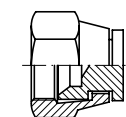

PIPE TUBO	THREAD ROSCA	Part nº Referencia	€	
6	1/4	7/16"-20h UNF	ZS13006	13,28
8	5/16	1/2"-20h UNF	ZS13008	15,34
10	3/8	9/16"-18h UNF	ZS13010	14,30
12	1/2	3/4"-16h UNF	ZS13012	17,90
14-15-16	5/8	7/8"-14h UNF	ZS13016	16,94
18-20	3/4	1"1/16-12h UN	ZS13020	24,34
25	1	1"5/16-12h UN	ZS13025	43,19
30-32	1 1/4	1"5/8-12h UN	ZS13032	60,46
38	1 1/2	1"7/8-12h UN	ZS13038	78,38

Racores JIC 37°

Flare fittings JIC 37°

Adapteurs JIC 37°

Raccordi JIC 37°

Racor macho-macho JIC 37°

Straight union JIC 37°

Adapteur droit mâle JIC 37°

Nipples di giunzione JIC

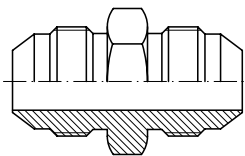

PIPE TUBO		THREAD ROSCA	Part n° Referencia	€
6	1/4	7/16" 20h UNF	ZS26006	12,74
8	5/16	1/2" 20h UNF	ZS26008	12,03
10	3/8	9/16" 18h UNF	ZS26010	14,63
12	1/2	3/4" 16h UNF	ZS26012	16,60
14-15-16	5/8	7/8" 14h UNF	ZS26016	20,32
18-20	3/4	1"1/16 12h UN	ZS26020	23,64
25	1	1"5/16 12h UN	ZS26025	32,16
30-32	1 1/4	1"5/8 12h UN	ZS26032	46,01
38	1 1/2	1"7/8 12h UN	ZS26038	69,12

Racor reducción macho-macho JIC 37°

Reducer adaptor male JIC 37°

Adapteur réduction mâle JIC 37°

Nipples di riduzione maschio-maschio JIC 37°

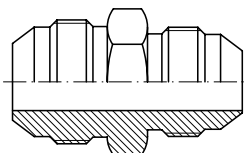

T.		THREAD ROSCA		Part n° Referencia	€
8 5/16	6 1/4	1/2" 20h UNF	7/16" 20h UNF	ZS2600806	14,44
10 5/16	6 1/4	9/16" 20h UNF	7/16" 20h UNF	ZS2601006	18,29
10 3/8	8 5/16	9/16" 20h UNF	1/2" 20h UNF	ZS2601008	17,56
12 1/2	10 3/8	3/4" 20h UNF	9/16" 20h UNF	ZS2601210	19,92
14-15-16 5/8	12 1/2	7/8" 20h UNF	3/4" 20h UNF	ZS2601612	24,38
18-20 3/4	14-15-16 5/8	1"1/16 20h UNF	7/8" 20h UNF	ZS2602016	28,37
25 1	18-20 3/4	1"5/16 20h UNF	1"1/16 20h UNF	ZS2602520	38,59
30-32 1 1/4	25 1	1"5/8 20h UNF	1"5/16 20h UNF	ZS2603225	55,21
38 1 1/2	30-32 1 1/4	1"7/8 20h UNF	1"5/8 20h UNF	ZS2603832	82,94

Racor pasatabiques JIC 37°

Straight bulkhead fitting JIC 37°

Union passe cloison droite mâle JIC 37° équipé

Nipples passaparete JIC

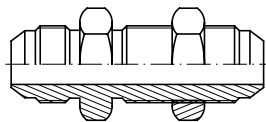

PIPE TUBO		THREAD ROSCA	Part n° Referencia	€
6	1/4	7/16" 20h UNF	ZS25006	21,80
8	5/16	1/2" 20h UNF	ZS25008	23,68
10	3/8	9/16" 18h UNF	ZS25010	23,02
12	1/2	3/4" 16h UNF	ZS25012	28,22
14-15-16	5/8	7/8" 14h UNF	ZS25016	34,48
18-20	3/4	1"1/16 12h UN	ZS25020	48,22
25	1	1"5/16 12h UN	ZS25025	67,65
30-32	1 1/4	1"5/8 12h UN	ZS25032	115,56
38	1 1/2	1"7/8 12h UN	ZS25038	129,95

Racor macho-macho JIC 37° con junta

Straight union JIC 37° with o'ring

Adapteur droit mâle JIC 37° avec o'ring

Nipples di giunzione JIC con o'ring

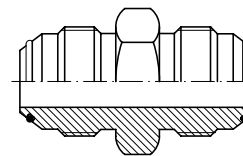

PIPE TUBO		THREAD ROSCA	Part n° Referencia	€
6	1/4	7/16" 20h UNF	ZS26006OR	16,38
8	5/16	1/2" 20h UNF	ZS26008OR	13,35
10	3/8	9/16" 18h UNF	ZS26010OR	17,58
12	1/2	3/4" 16h UNF	ZS26012OR	22,05
14-15-16	5/8	7/8" 14h UNF	ZS26016OR	26,89
18-20	3/4	1"1/16 12h UN	ZS26020OR	42,58
25	1	1"5/16 12h UN	ZS26025OR	52,04
30-32	1 1/4	1"5/8 12h UN	ZS26032OR	81,67
38	1 1/2	1"7/8 12h UN	ZS26038OR	120,62

Racor macho JIC 37° - macho Métrico

Metric adaptor male - male JIC 37°

Adapteur mâle JIC 37° - mâle Métrique

Nipples di congiunzione maschio JIC 37° - maschio Metrico

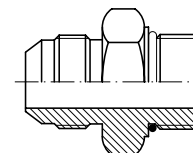

PIPE TUBO		THREAD ROSCA		Part n° Referencia	€
6	1/4	M10x1	7/16" 20h UNF	ZS2400610	18,82
8	5/16	M10x1	1/2" 20h UNF	ZS2400810 *	17,36
8	5/16	M12x1.5	1/2" 20h UNF	ZS2400812	17,14
8	5/16	M14x1.5	1/2" 20h UNF	ZS2400814 *	14,34
10	3/8	M12x1.5	9/16" 18h UNF	ZS2401012	20,01
10	3/8	M14x1.5	9/16" 18h UNF	ZS2401014	24,39
10	3/8	M16x1.5	9/16" 18h UNF	ZS2401016	20,43
12	1/2	M14x1.5	3/4" 16h UNF	ZS2401214	23,96
12	1/2	M16x1.5	3/4" 16h UNF	ZS2401216	20,79
12	1/2	M18x1.5	3/4" 16h UNF	ZS2401218	21,29
14-15-16	5/8	M18x1.5	7/8" 14h UNF	ZS2401418	40,35
14-15-16	5/8	M27x2	7/8" 14h UNF	ZS2401427 *	23,02
14-15-16	5/8	M22x1.5	7/8" 14h UNF	ZS2401622	42,46
18-20	3/4	M22x1.5	1"1/16 12h UN	ZS2402022	42,46
18-20	3/4	M27X2	1"1/16 12h UN	ZS2402027	43,75
25	1	M27x2	1"5/16 12h UNF	ZS2402527 *	51,02
25	1	M33x2	1"5/16 12h UN	ZS2402533	54,59
30-32	1 1/4	M42x2	1"5/8 12h UN	ZS2403242	88,66
38	1 1/2	M50x2	1"7/8 12h UN	ZS2403850	129,35

*Hasta fin de existencias. / *Until end of stock. / *Jusqu'à la fin du stock. / *Fino ad esaurimento scorta.

Racores JIC 37°

Flare fittings JIC 37°

Adaptateurs JIC 37°

Raccordi JIC 37°

Racor macho JIC 37° - macho NPT

Straight adaptor male JIC 37° - male NPT pipe

Adaptateur mâle JIC 37° - mâle NPT (BRIGGS)

Niples di congiunzione JIC 37° - NPT

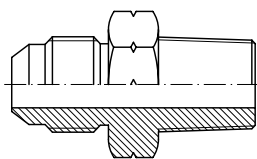

PIPE TUBO		THREAD ROSCA		Part nº Referencia	€
6	1/4	7/16" 20h UNF	1/8" NPT	ZS2000610	13,57
6	1/4	7/16" 20h UNF	1/4" NPT	ZS2000613	9,65
8	5/16	1/2" 20h UNF	1/8" NPT	ZS2000810	9,40
8	5/16	1/2" 20h UNF	1/4" NPT	ZS2000813	12,63
8	5/16	1/2" 20h UNF	3/8" NPT	ZS2000817	13,47
10	3/8	9/16" 18h UNF	1/8" NPT	ZS2001010	14,80
10	3/8	9/16" 18h UNF	1/4" NPT	ZS2001013	10,84
10	3/8	9/16" 18h UNF	3/8" NPT	ZS2001017	12,42
10	3/8	9/16" 18h UNF	1/2" NPT	ZS2001021	20,29
12	1/2"	3/4" 20h UNF	1/4" NPT	ZS2001213	15,92
12	1/2"	3/4" 16h UNF	3/8" NPT	ZS2001217	15,99
12	1/2"	3/4" 16h UNF	1/2" NPT	ZS2001221	16,62
12	1/2"	3/4" 16h UNF	3/4" NPT	ZS2001226	21,74
14-15-16	5/8	7/8" 14h UNF	1/2" NPT	ZS2001621	23,45
14-15-16	5/8	7/8" 14h UNF	3/4" NPT	ZS2001626	21,69
18-20	3/4	1"1/16 12h UN	1/2" NPT	ZS2002021	25,32
18-20	3/4	1"1/16 12h UN	3/4" NPT	ZS2002026	27,69
18-20	3/4	1"1/16 12h UN	1" NPT	ZS2002033	32,79
25	1	1"5/16 12h UN	3/4" NPT	ZS2002526	35,28
25	1	1"5/16 12h UN	1" NPT	ZS2002533	34,34
30-32	1	1"5/16 12h UN	1" 1/4 NPT	ZS2002542	71,94
30-32	1 1/4	1"5/8 12h UN	1" NPT	ZS2003233	69,31
30-32	1 1/4	1"5/8 12h UN	1 1/4" NPT	ZS2003242	60,40
38	1 1/2	1"7/8 12h UN	1 1/4" NPT	ZS2003842	70,84
38	1 1/2	1"7/8 12h UN	1 1/2" NPT	ZS2003848	68,43

Hembra giratoria JIC 37° - macho UNF

Straight adaptor swivel female JIC 37° - male UNF

Adaptateur femelle tournante JIC 37° - mâle UNF

Niples femmina girevole JIC 37° - maschio UNF

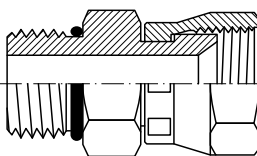

PIPE TUBO		THREAD ROSCA		Part nº Referencia	€
6	1/4	F 7/16" 20h UNF	M 7/16" 20h UNF	ZS38006	*
10	3/8	F 9/16" 18h UNF	M 9/16" 18h UNF	ZS38010	*
12	1/2	F 3/4" 16h UNF	M 3/4" 16h UNF	ZS38012	*
14-15-16	5/8	F 7/8" 14h UNF	M 7/8" 14h UNF	ZS38016	*
18-20	3/4	F 1"1/16 12h UN	M 1"1/16 12h UN	ZS38020	*
25	1	F 1"5/16 12h UN	M 1"5/16 12h UN	ZS38025	*

*Ver precios en p.162 (ADAPTADORES O RING BOSS) / *See prices in p.162 (O RING BOSS ADAPTORS) / *Prix à la p.162 (ADAPTEURS O RING BOSS) / *Vedere prezzi p.162 (ADATTATORI O RING BOSS)

Racor macho JIC 37° - macho BSP

Straight adaptor male JIC 37° - male BSP

Adaptateur mâle JIC 37° - mâle BSP équipé

Niples di congiunzione JIC - BSP

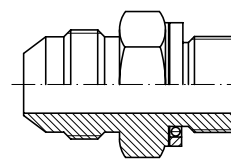

PIPE TUBO		THREAD ROSCA		Part nº Referencia	€
6	1/4	7/16" 20h UNF	1/8" BSP	ZS2300610	10,97
6	1/4	7/16" 20h UNF	1/4" BSP	ZS2300613	11,29
6	1/4	7/16" 20h UNF	3/8" BSP	ZS2300617	19,51
6	1/4	7/16" 20h UNF	1/2" BSP	ZS2300621	39,25
8	5/16	1/2" 20h UNF	1/4" BSP	ZS2300813	19,53
8	5/16	1/2" 20h UNF	3/8" BSP	ZS2300817	18,37
10	3/8	9/16" 18h UNF	1/4" BSP	ZS2301013	12,71
10	3/8	9/16" 18h UNF	3/8" BSP	ZS2301017	13,77
10	3/8	9/16" 18h UNF	1/2" BSP	ZS2301021	19,83
12	1/2"	3/4" 16h UNF	1/4" BSP	ZS2301213	17,99
12	1/2"	3/4" 16h UNF	3/8" BSP	ZS2301217	16,78
12	1/2"	3/4" 16h UNF	1/2" BSP	ZS2301221	16,65
12	1/2"	3/4" 16h UNF	3/4" BSP	ZS2301226	31,59
14-15-16	5/8	7/8" 14h UNF	3/8" BSP	ZS2301617	23,26
14-15-16	5/8	7/8" 14h UNF	1/2" BSP	ZS2301621	21,01
18-20	3/4	1"1/16 12h UN	1/2" BSP	ZS2302021	27,32
18-20	3/4	1"1/16 12h UN	3/4" BSP	ZS2302026	25,70
18-20	3/4	1"1/16 12h UN	1" BSP	ZS2302033	49,86
25	1	1"5/16 12h UN	1/2" BSP	ZS2302521 *	36,51
25	1	1"5/16 12h UN	3/4" BSP	ZS2302526	34,72
25	1	1"5/16 12h UN	1" BSP	ZS2302533	45,43
25	1	1"5/16 12h UN	1"1/4 BSP	ZS2302542	68,91
30-32	1 1/4	1"5/8 12h UN	1"1/4 BSP	ZS2303242	73,26
38	1 1/2	1"7/8 12h UN	1"1/4 BSP	ZS2303842	90,55
38	1 1/2	1"7/8 12h UN	1"1/2 BSP	ZS2303848	108,22
38	1 1/2	1"7/8 12h UN	2" BSP	ZS2303860	155,20

*Hasta fin de existencias. / *Until end of stock. / *Jusqu'à la fin du stock. / *Fino ad esaurimento scorta.

Racor macho BSP - hembra giratoria JIC 37°

Straight adaptor male BSP - swivel female JIC 37°

Adaptateur mâle BSP - femelle tournante JIC 37°

Niples di congiunzione maschio BSP - femmina girevole JIC 37°

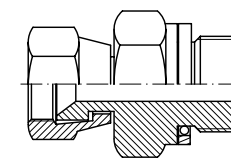

T.	THREAD ROSCA		Part nº Referencia	€	
6	1/4	M 1/8" BSP	F 7/16" 20h UNF	ZS1800610	21,44
8	5/16	M 1/4" BSP	F 1/2" 20h UNF	ZS1800813	19,22
10	3/8	M 1/4" BSP	F 9/16" 18h UNF	ZS1801013	16,65
10	3/8	M 3/8" BSP	F 9/16" 18h UNF	ZS1801017	20,65
10	3/8	M 1/2" BSP	F 9/16" 18h UNF	ZS1801021	23,46
12	1/2"	M 3/8" BSP	F 3/4" 16h UNF	ZS1801217	22,21
14-15-16	5/8	M 1/2" BSP	F 7/8" 14h UNF	ZS1801621	27,24
18-20	3/4	M 3/4" BSP	F 1" 1/16 12h UNF	ZS1802026	39,71
25	1	M 1" BSP	F 1" 5/16 12h UNF	ZS1802533	63,87
30-32	1 1/4	M 1" 1/4 BSP	F 1" 5/8 12h UNF	ZS1803242	108,34
38	1 1/2	M 1" 1/2 BSP	F 1" 7/8 12h UNF	ZS1803848	157,78

Racores JIC 37°

Flare fittings JIC 37°

Adaptateurs JIC 37°

Raccordi JIC 37°

Racor macho JIC 37° - macho BSPT

Straight adaptor male JIC 37° - male BSPT

Adaptateur mâle JIC 37° - mâle BSPT

Niples di congiunzione JIC - BSPT

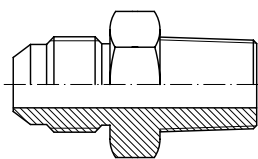

PIPE TUBO		THREAD ROSCA		Part nº Referencia	€
6	1/4	7/16" 20h UNF	1/8" BSPT	ZS2100610	13,36
6	1/4	7/16" 20h UNF	1/4" BSPT	ZS2100613	10,66
8	5/16	1/2" 20h UNF	1/8" BSPT	ZS2100810	13,24
8	5/16	1/2" 20h UNF	1/4" BSPT	ZS2100813	14,70
8	5/16	1/2" 20h UNF	3/8" BSPT	ZS2100817	13,55
10	3/8	9/16" 18h UNF	1/4" BSPT	ZS2101013	14,50
10	3/8	9/16" 18h UNF	3/8" BSPT	ZS2101017	15,08
10	3/8	9/16" 18h UNF	1/2" BSPT	ZS2101021	20,68
12	1/2	3/4" 16h UNF	1/4" BSPT	ZS2101213	17,12
12	1/2	3/4" 16h UNF	3/8" BSPT	ZS2101217	17,16
12	1/2	3/4" 16h UNF	1/2" BSPT	ZS2101221	16,58
12	1/2	3/4" 12h UNF	3/8	ZS2101226	22,56
14-15-16	5/8	7/8" 14h UNF	3/8" BSPT	ZS2101617	22,85
14-15-16	5/8	7/8" 14h UNF	1/2" BSPT	ZS2101621	19,78
14-15-16	5/8	7/8" 14h UNF	3/4" BSPT	ZS2101626	25,69
18-20	3/4	1"1/16 12h UN	1/2" BSPT	ZS2102021	23,50
18-20	3/4	1"1/16 12h UN	3/4" BSPT	ZS2102026	27,46
18-20	3/4	1"1/16 12h UN	1" BSPT	ZS2102033	36,92
25	1	1"5/16 12h UN	3/4" BSPT	ZS2102526	35,99
25	1	1"5/16 12h UN	1" BSPT	ZS2102533	35,73
30-32	1 1/4	1"5/8 12h UN	1" BSPT	ZS2103233	55,07
30-32	1 1/4	1"5/8 12h UN	1 1/4" BSPT	ZS2103242	60,47
38	1 1/2	1"7/8 12h UN	1 1/2" BSPT	ZS2103848	78,94

Racor macho JIC 37° - hembra fija NPT

Straight adaptor male JIC 37° - fixed female NPT

Adaptateur mâle JIC 37° - femelle fixe NPT

Niples di congiunzione maschio JIC 37° - femmina fissa NPT

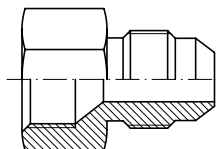

PIPE TUBO		THREAD ROSCA		Part nº Referencia	€
6	1/4	M 7/16"-20h UN	F 1/8 NPT	ZS2950610	15,94
6	1/4	M 7/16"-20h UN	F 1/4 NPT	ZS2950613	22,06
8	5/16	M 1/2"-20h UNF	F 1/4" NPT	ZS2950813	26,32
8	5/16	M 1/2"-20h UN	F 3/8 NPT	ZS2950817	*
10	3/8	M 9/16"-20h UN	F 1/4 NPT	ZS2951013	*
10	3/8	M 9/16"-18h UNF	F 3/8" NPT	ZS2951017	31,58
12	1/2	M 3/4"-20h UN	F 1/4 NPT	ZS2951213	*
12	1/2	M 3/4"-16h UNF	F 3/8" NPT	ZS2951217	22,66
12	1/2	M 3/4"-16h UNF	F 1/2" NPT	ZS2951221	32,64
14-15-16	5/8	M 7/8"-14h UNF	F 1/2" NPT	ZS2951621	35,32
18-20	3/4	M 1"1/16-12h UN	F 3/4" NPT	ZS2952026	41,39
18-20	3/4	M 1"1/16"-20h UN	F 1" NPT	ZS2952033	*
25	1	M 1"5/16-12 UN	F 1" NPT	ZS2952533	56,85
25	1	M 1"5/16-12 UN	F 1"1/4 NPT	ZS2952542	*

Racor reducción macho JIC 37° - hembra giratoria JIC 37°

Reducer adaptor male JIC 37° -swivel female JIC 37°

Adaptateur réduction mâle JIC 37° - femelle tournante JIC 37°

Niples di riduzione maschio - femmina girevole JIC 37°

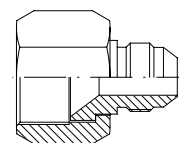

T.		THREAD ROSCA		Part nº Referencia	€
F 6	M 8	F 7/16" 20h UNF	M 1/2" 20h UNF	ZS2900608	14,85
F 6	M 12	F 7/16" 20h UNF	M 3/4" 16h UNF	ZS2900612	*
F 8	M 14-15-16	F 1/2" 20h UNF	M 7/8" 14h UNF	ZS2900816	*
F 8	M 18-20	F 1/2" 20h UNF	M 1"1/16 12h UN	ZS2900820	*
F 8	M 25	F 1/2" 20h UNF	M 1"5/16 12h UN	ZS2900825	*
F 10	M 6	F 9/16" 18h UNF	M 7/16" 20h UNF	ZS2901006	16,95
F 10	M 8	F 9/16" 18h UNF	M 1/2" 20h UNF	ZS2901008 *	24,74
F 10	M 14-15-16	F 9/16" 18h UNF	M 7/8" 14h UNF	ZS2901016	29,22
F 10	M 25	F 9/16" 18h UNF	M 1"5/16 12h UN	ZS2901025	*
F 12	M 6	F 3/4" 16h UNF	M 7/16" 20h UNF	ZS2901206	19,05
F 12	M 8	F 3/4" 16h UNF	M 1/2" 20h UNF	ZS2901208	19,39
F 12	M 10	F 3/4" 16h UNF	M 9/16" 18h UNF	ZS2901210	20,23
F 12	M 25	F 3/4" 16h UNF	M 1"5/16 12h UN	ZS2901225	43,71
F 12	M 30-32	F 3/4" 16h UNF	M 1"5/8 12h UN	ZS2901232	*
F 12	M 38	F 3/4" 16h UNF	M 1"7/8 12h UN	ZS2901238	*
F 14-15-16	M 6	F 7/8" 14h UNF	M 7/16" 20h UNF	ZS2901606	22,63
F 14-15-16	M 10	F 7/8" 14h UNF	M 9/16" 18h UNF	ZS2901610	25,41
F 14-15-16	M 12	F 7/8" 14h UNF	M 3/4" 16h UNF	ZS2901612 *	26,74
F 14-15-16	M 18-20	F 7/8" 14h UNF	M 1"1/16 12h UN	ZS2901620	35,83
F 14-15-16	M 25	F 7/8" 14h UNF	M 1"5/8 12h UN	ZS2901625	*
F 14-15-16	M 30-32	F 7/8" 14h UNF	M 1"5/8 12h UN	ZS2901632	*
F 14-15-16	M 38	F 7/8" 14h UNF	M 1"7/8 12h UN	ZS2901638	*
F 18-20	M 6	F 1"1/16 12h UN	M 7/16" 20h UNF	ZS2902006	34,52
F 18-20	M 10	F 1"1/16 12h UN	M 9/16" 18h UNF	ZS2902010	30,93
F 18-20	M 12	F 1"1/16 12h UN	M 3/4" 16h UNF	ZS2902012	29,24
F 18-20	M 30-32	F 1"1/16 12h UN	M 1"5/8 12h UN	ZS2902032	51,13
F 25	M 18-20	F 1"5/16 12h UN	M 1"1/16 12h UN	ZS2902520	52,08
F 25	M 38	F 1"5/16 12h UN	M 1"7/8 12h UN	ZS2902538	73,86
F 30-32	M 18-20	F 1"5/8 12h UN	M 1"1/16 12h UN	ZS2903020	64,08
F 30-32	M 25	F 1"5/8 12h UN	M 1"5/16 12h UN	ZS2903225	66,21
F 38	30-32	F 1"7/8 12h UN	M 1"5/8 12h UN	ZS2903832	128,81

*Hembra fija; Pueden ser suministradas con tuerca libre o prensada / *Fixed female; material could be delivered with loose or crimped nut / * Femelle fixe, peut être livrée avec écrou libre ou pré-serti / * Femmina fissa; fornibile con dado libero o pressato

Racores JIC 37°

Flare fittings JIC 37°
Adapteurs JIC 37°
Raccordi JIC 37°

Hembra giratoria JIC 37° - macho NPT

Straight adaptor swivel female JIC 37° - male NPT pipe

Adapteur femelle tournante JIC 37° - mâle NPT

Nipples femmina girevole JIC 37° - maschio NPT

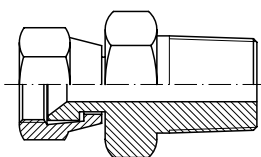

THREAD ROSCA		Part nº Referencia	€
7/16"-20h UNF	1/4" NPT	ZS1850613	20,76
9/16"-18h UNF	3/8" NPT	ZS1851017	21,54
3/4"-16h UNF	3/8" NPT	ZS1851217	24,45
3/4"-16h UNF	1/2" NPT	ZS1851221	29,42
7/8"-14h UNF	1/2" NPT	ZS1851621	27,50
1"1/16-12h UNF	3/4" NPT	ZS1852026	37,18
1"5/16-12h UNF	1" NPT	ZS1852533	65,75

Juntas tóricas FKM verde para macho Métrico

FKM green o'ring for Metric thread

Joint torique FKM vert pour filetage métrique

Guarnizione FKM verde per maschio metrico



THREAD ROSCA	Part nº Referencia	€
M10x1	JVMET10	0,23
M12x1.5	JVMET12	0,31
M14x1.5	JVMET14	0,31
M16x1.5	JVMET16	0,36
M18x1.5	JVMET18	0,44
M22x1.5	JVMET22	0,52
M27x2	JVMET27	0,68
M33x2	JVMET33	1,64
M42x2	JVMET42	3,11
M50x2	JVMET50	1,44

Juntas tóricas FKM verde para rosca UNF

FKM green o'ring for UNF thread

Joint torique FKM vert pour filetage UNF

Guarnizione FKM verde per filetto UNF



THREAD ROSCA	Part nº Referencia	€
7/16" UNF	JVUNF06	0,34
1/2" UNF	JVUNF08	0,58
9/16" UNF	JVUNF10	0,74
3/4" UNF	JVUNF12	0,83
7/8" UNF	JVUNF16	1,08
1" 1/16 UNF	JVUNF20	1,26
1"5/16 UNF	JVUNF25	3,03
1" 5/8 UNF	JVUNF32	4,05
1" 7/8 UNF	JVUNF38	3,92

Racor hembra giratoria - hembra giratoria JIC 37°

Straight adaptor swivel female JIC 37°

Adapteur femelle tournante JIC 37°

Nipples femmina - femmina girevole JIC

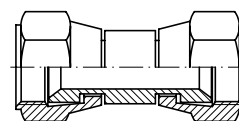

PIPE TUBO		THREAD ROSCA	Part nº Referencia	€
6	1/4"	7/16" 20h UNF	ZS73006	20,02
8	5/16"	1/2" 20h UNF	ZS73008	21,90
10	3/8"	9/16" 18h UNF	ZS73010	21,73
12	1/2"	3/4" 16h UNF	ZS73012	23,06
14-15-16	5/8"	7/8" 14h UNF	ZS73016	31,50
18-20	3/4"	1"1/16 12h UN	ZS73020	46,70
25	1"	1"5/16 12h UN	ZS73025	65,60
32	1"1/4	1"5/8 12h UN	ZS73032	119,84
38	1"1/2	1"7/8 12h UN	ZS73038	139,72

Juntas tóricas FKM verde para macho BSP

FKM green o'ring for BSP thread

Joint torique FKM vert pour mâle BSP

Guarnizione FKM verde per maschio BSP



THREAD ROSCA	Part nº Referencia	€
1/8" BSP	JVMBSP02	0,26
1/4" BSP	JVMBSP04	0,35
3/8" BSP	JVMBSP06	0,44
1/2" BSP	JVMBSP08	0,56
3/4" BSP	JVMBSP12	0,68
1" BSP	JVMBSP16	1,50
1"1/4 BSP	JVMBSP20	1,89
1"1/2 BSP	JVMBSP24	2,13
2" BSP	JVMBSP32	3,16

Juntas para Macho JIC FKM verde

FKM green o'ring for JIC male thread

Joint FKM vert pour mâle JIC

Guarnizione per maschio JIC FKM verde



THREAD ROSCA	Part nº Referencia	€
7/16" 20h UNF	JTVJIC07	0,17
9/16" 18h UNF	JTVJIC09	0,17
3/4" 16h UNF	JTVJIC12	0,21
1"1/16 12h UNF	JTVJIC17	0,28
1" 5/16 12h UN	JTVJIC21	0,27
1"5/8 12h UNF	JTVJIC26	0,33

Racores JIC 37°

Flare fittings JIC 37°

Adaptateurs JIC 37°

Raccordi JIC 37°

Crimping fittings for hoses

Pipe fittings

Pipe fittings II

Adaptors

Welding fittings

Industrial fittings

Accessories

Control components

Flow measuring

Trile LOK

Codo 90° macho - macho JIC 37°

90° Elbow male - male JIC 37°

Coude 90° mâle - mâle JIC 37°

Adattatore a 90° maschio - maschio JIC 37°

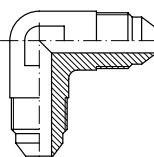

PIPE TUBO	THREAD ROSCA	Part nº Referencia	€
6	1/4"	7/16" 20h UNF	ZS50006 26,23
8	5/16"	1/2" 20h UNF	ZS50008 28,43
10	3/8"	9/16" 18h UNF	ZS50010 25,30
12	1/2"	3/4" 16h UNF	ZS50012 44,51
14-15-16	5/8"	7/8" 14h UNF	ZS50016 68,42
18-20	3/4"	1" 1/16 12h UN	ZS50020 65,86
25	1"	1" 5/16 12h UN	ZS50025 90,68
30-32	1" 1/4	1" 5/8 12h UN	ZS50032 115,50
38	1" 1/2	1" 7/8 12h UN	ZS50038 199,39

Codo 90° macho JIC 37° - hembra giratoria JIC 37°

90° Elbow swivel female JIC 37° - male JIC 37°

Coude 90° mâle JIC 37° - femelle tournante JIC 37°

Adattatore a 90° maschio JIC 37° - femmina girevole JIC 37°

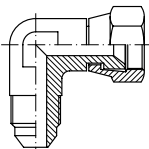

T.	THREAD ROSCA	Part nº Referencia	€
6	1/4"	M 7/16" 20h UNF F 7/16" 20h UNF	ZS67506 31,66
8	5/16"	M 1/2" 20h UNF F 1/2" 20h UNF	ZS67508 32,12
10	3/8"	M 9/16" 18h UNF F 9/16" 18h UNF	ZS67510 30,56
12	1/2"	M 3/4" 16h UNF F 3/4" 16h UNF	ZS67512 42,85
14-15-16	5/8"	M 7/8" 14h UNF F 7/8" 14h UNF	ZS67516 55,25
18-20	3/4"	M 1" 1/16 12h UNF F 1" 1/16 12h UNF	ZS67520 69,70
25	1"	M 1" 5/16 12h UNF F 1" 5/16 12h UNF	ZS67525 114,89
30-32	1" 1/4	M 1" 5/8 12h UNF F 1" 5/8 12h UNF	ZS67532 148,36
38	1" 1/2	M 1" 7/8 12h UNF F 1" 7/8 12h UNF	ZS67538 216,38

Codo 90° macho - macho JIC 37° con junta

90° Elbow male - male JIC 37° with o'ring

Coude 90° mâle - mâle JIC 37° avec o'ring

Adattatore a 90° maschio - maschio JIC 37° con o'ring

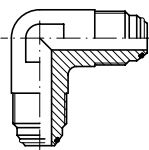

PIPE TUBO	THREAD ROSCA	Part nº Referencia	€
6	1/4"	7/16" 20h UNF	ZS50006OR 34,91
8	5/16"	1/2" 20h UNF	ZS50008OR 38,07
10	3/8"	9/16" 18h UNF	ZS50010OR 38,30
12	1/2"	3/4" 16h UNF	ZS50012OR 47,85
14-15-16	5/8"	7/8" 14h UNF	ZS50016OR 67,80
18-20	3/4"	1" 1/16 12h UN	ZS50020OR 91,28
25	1"	1" 5/16 12h UN	ZS50025OR 132,07
30-32	1 1/4	1" 5/8 12h UN	ZS50032OR 162,29
38	1 1/2	1" 7/8 12h UN	ZS50038OR 280,16

Codo 90° pasatabiques macho - macho JIC 37°

90° Bulkhead elbow male - male JIC 37°

Coude 90° passe cloison mâle-mâle JIC 37°

Adattatore a 90° passaparete maschio - maschio JIC 37°

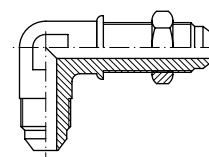

PIPE TUBO	THREAD ROSCA	Part nº Referencia	€
6	1/4"	7/16" - 20h UNF 7/16" - 20h UNF	ZS65006 65,51
8	5/16"	1/2" - 20h UNF 1/2" - 20h UNF	ZS65008 77,32
10	3/8"	9/16" - 18h UNF 9/16" - 18h UNF	ZS65010 76,03
12	1/2"	3/4" - 16h UNF 3/4" - 16h UNF	ZS65012 92,24
14-15-16	5/8"	7/8" - 14h UNF 7/8" - 14h UNF	ZS65016 114,17
18-20	3/4"	1" 1/16 - 12h UN 1" 1/16 - 12h UN	ZS65020 168,04
25	1"	1" 5/16 - 12h UN 1" 5/16 - 12h UN	ZS65025 200,08

Codo 90° regulable macho JIC 37°- macho BSP

90° Adjustable stud elbow male JIC 37°-male BSP

Coude 90° orientable mâle JIC 37°- mâle BSP

Adattatore a 90° orientabile maschio JIC 37°- maschio BSP

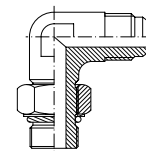

PIPE TUBO	THREAD ROSCA	Part nº Referencia	€
6	1/4"	7/16" 20h UNF 1/4" BSP	ZS5700613 22,56
10	13	9/16 20H UNF 1/4 BSP	ZS5701013 46,03
10	3/8"	9/16" 18h UNF 3/8" BSP	ZS5701017 34,68
12	1/2"	3/4 20H UNF 3/8 BSP	ZS5701217 62,23
12	1/2"	3/4" 16h UNF 1/2" BSP	ZS5701221 52,43
14-15-16	5/8"	7/8" 14h UNF 1/2" BSP	ZS5701621 57,13
18-20	3/4"	1" 1/16 12h UN 3/4" BSP	ZS5702026 83,30
25	1"	1" 5/16 12h UN 1" BSP	ZS5702533 131,68
30-32	1 1/4	1 5/8 12H UN 1 1/4 BSP	ZS5703242 448,62
38	1 1/2	1" 7/8 12h UN 1" 1/2 BSP	ZS5703848 747,93

Codo 90° regulable macho - macho JIC 37°

90° Adjustable stud elbow male-male JIC 37°

Coude 90° orientable mâle - mâle JIC 37°

Adattatore a 90° orientabile maschio - maschio JIC 37°

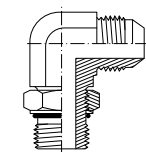

PIPE TUBO	THREAD ROSCA	Part nº Referencia	€
6	1/4"	7/16" - 20h UNF 7/16" - 20h UNF	ZS57506 *
8	5/16"	1/2" - 20h UNF 1/2" - 20h UNF	ZS57508 *
10	3/8"	9/16" - 18h UNF 9/16" - 18h UNF	ZS57510 *
12	1/2"	3/4" - 16h UNF 3/4" - 16h UNF	ZS57512 *
14-15-16	5/8"	7/8" - 14h UNF 7/8" - 14h UNF	ZS57516 *
18-20	3/4"	1" 1/16 - 12h UN 1" 1/16 - 12h UN	ZS57520 *
25	1"	1" 5/16 - 12h UN 1" 5/16 - 12h UN	ZS57525 *

*Ver precios en p. 163 (ADAPTADORES O'RING BOSS) / *See prices in p. 163 (O'RING BOSS ADAPTORS) / *Voir prix à la p. 163 (ADAPTEURS O'RING BOSS) / *Vedere prezzi p. 163 (ADATTATORI O'RING BOSS)

Racores JIC 37°

Flare fittings JIC 37°
Adapteurs JIC 37°
Raccordi JIC 37°

Codo 90° macho JIC 37° - macho BSPT

90° Elbow male JIC 37° - male BSPT

Coude 90° mâle JIC 37° - mâle BSPT

Adattatore a 90° maschio JIC 37° - maschio BSPT

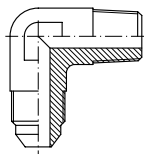

PIPE TUBO		THREAD ROSCA		Part nº Referencia	€
6	1/4	1/8" BSPT	7/16" 20h UNF	ZS5500610	35,31
6	1/4	1/4" BSPT	7/16" 20h UNF	ZS5500613	36,01
8	5/16	1/8" BSPT	1/2" 20h UNF	ZS5500810	36,90
8	5/16	1/4" BSPT	1/2" 20h UNF	ZS5500813	35,08
10	3/8	1/4" BSPT	9/16" 18h UNF	ZS5501013	29,19
10	3/8	3/8" BSPT	9/16" 18h UNF	ZS5501017	43,65
10	3/8	1/2" BSPT	9/16" 18h UNF	ZS5501021	43,10
12	1/2	1/4" BSPT	3/4" 16h UNF	ZS5501213	49,08
12	1/2	3/8" BSPT	3/4" 16h UNF	ZS5501217	57,96
12	1/2	1/2" BSPT	3/4" 16h UNF	ZS5501221	44,90
14-15-16	5/8	3/8" BSPT	7/8" 14h UNF	ZS5501617	56,98
14-15-16	5/8	1/2" BSPT	7/8" 14h UNF	ZS5501621	64,07
14-15-16	5/8	3/4" BSPT	7/8" 14h UNF	ZS5501626	108,75
18-20	3/4	1/2" BSPT	1"1/16 12h UN	ZS5502021	74,30
18-20	3/4	3/4" BSPT	1"1/16 12h UN	ZS5502026	77,72
25	1	3/4" BSPT	1"5/16 12h UN	ZS5502526	135,79
25	1	1" BSPT	1"5/16 12h UN	ZS5502533	108,51
30-32	1 1/4	1 1/4" BSPT	1"5/8 12h UN	ZS5503242 *	217,55

*Hasta fin de existencias. / *Until end of stock. / *Jusqu'à la fin du stock. / *Fino ad esaurimento scorta.

Codo 90° macho NPT - hembra giratoria JIC 37°

90° Elbow male NPT - swivel female JIC 37°

Coude 90° mâle NPT - femelle tournante JIC 37°

Adattatore a 90° maschio NPT - femmina girevole JIC 37°

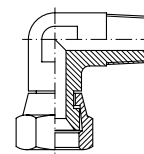

THREAD ROSCA		Part nº Referencia	€
1/8" NPT	7/16"-20h UNF	ZS5950610	28,55
1/4" NPT	1/2"-20h UNF	ZS5950813	31,49
1/4" NPT	9/16"-18h UNF	ZS5951013	32,32
3/8" NPT	3/4"-16h UNF	ZS5951217	42,76
1/2" NPT	7/8"-14h UNF	ZS5951621	58,37
3/4" NPT	1"1/16"-12h UN	ZS5952026	74,16
1" NPT	1"5/16"-12h UN	ZS5952533	110,08

Codo 90° macho JIC 37° - macho NPT

90° Elbow male JIC 37° - male NPT

Coude 90° mâle JIC 37° - mâle NPT

Adattatore a 90° maschio JIC 37° - maschio NPT

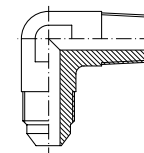

PIPE TUBO		THREAD ROSCA		Part nº Referencia	€
6	1/4	1/8" NPT	7/16" 20h UNF	ZS5250610	33,30
6	1/4	1/4" NPT	7/16" 20h UNF	ZS5250613	31,90
8	5/16	1/8" NPT	1/2" 20h UNF	ZS5250810	28,95
8	5/16	1/4" NPT	1/2" 20h UNF	ZS5250813	28,24
10	3/8	1/4" NPT	9/16" 18h UNF	ZS5251013	26,24
10	3/8	3/8" NPT	9/16" 18h UNF	ZS5251017	32,54
10	3/8	1/2" NPT	9/16" 18h UNF	ZS5251021	43,51
12	1/2	1/4" NPT	3/4" 16h UNF	ZS5251213	40,09
12	1/2	3/8" NPT	3/4" 16h UNF	ZS5251217	44,66
12	1/2	1/2" NPT	3/4" 16h UNF	ZS5251221	42,05
14-15-16	5/8	3/8" NPT	7/8" 14h UNF	ZS5251617	56,56
14-15-16	5/8	1/2" NPT	7/8" 14h UNF	ZS5251621	42,96
14-15-16	5/8	3/4" NPT	7/8" 14h UNF	ZS5251626	63,94
18-20	3/4	1/2" NPT	1"1/16 12h UN	ZS5252021	73,23
18-20	3/4	3/4" NPT	1"1/16 12h UN	ZS5252026	69,47
25	1	3/4" NPT	1"5/16 12h UN	ZS5252526	90,17
25	1	1" NPT	1"5/16 12h UN	ZS5252533	97,49
30-32	1 1/4	1 1/4" NPT	1"5/8 12h UN	ZS5253242	59,89

Racores JIC 37°

Flare fittings JIC 37°

Adapteurs JIC 37°

Raccordi JIC 37°

Crimping fittings for hoses

Pipe fittings

Pipe fittings II

Adaptors

Welding fittings

Industrial fittings

Accessories

Control components

Flow measuring

Tr/Me LOK

Codo 45° macho JIC 37° - hembra giratoria JIC 37°

45° Elbow male JIC 37° - swivel female JIC 37°

Coude 45° mâle JIC 37° - femelle tournante JIC 37°

Adattatore a 45° maschio JIC 37° - femmina girevole JIC 37°

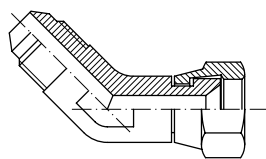

PIPE TUBO		THREAD ROSCA		Part n° Referencia	€
6	1/4	M 7/16" 20h UNF	F 7/16" 20h UNF	ZS69006	18,09
8	5/16	M 1/2" 20h UNF	F 1/2" 20h UNF	ZS69008	21,28
10	3/8	M 9/16" 18h UNF	F 9/16" 18h UNF	ZS69010	23,38
12	1/2	M 3/4" 16h UNF	F 3/4" 16h UNF	ZS69012	41,26
14-15-16	5/8	M 7/8" 14h UNF	F 7/8" 14h UNF	ZS69016	52,43
18-20	3/4	M 1"1/16 12h UN	F 1"1/16 12h UN	ZS69020	305,78
25	1	M 1"5/16 12h UN	F 1"5/16 12h UN	ZS69025	446,86

Codo 45° regulable macho - macho JIC 37°

45° Adjustable stud elbow male - male JIC 37°

Coude 45° orientable mâle - mâle JIC 37°

Adattatore a 45° orientabile maschio - maschio JIC 37°

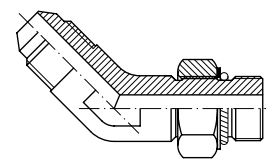

PIPE TUBO		THREAD ROSCA		Part n° Referencia	€
6	1/4	7/16" - 20h UNF	7/16" - 20h UNF	ZS77506	71,32
8	5/16	1/2" - 20h UNF	1/2" - 20h UNF	ZS77508	73,80
10	3/8	9/16" - 18h UNF	9/16" - 18h UNF	ZS77510	67,76
12	1/2	3/4" - 16h UNF	3/4" - 16h UNF	ZS77512	84,41
14-15-16	5/8	7/8" - 14h UNF	7/8" - 14h UNF	ZS77516	153,98
18-20	3/4	1" 1/16 - 12h UN	1" 1/16 - 12h UN	ZS77520	320,53
25	1	1" 5/16 - 12h UN	1" 5/16 - 12h UN	ZS77525	415,30

Codo 45° macho JIC 37° - macho NPT

45° Elbow male JIC 37° - male NPT pipe

Coude 45° mâle JIC 37° - mâle NPT

Adattatore a 45° maschio JIC 37° - maschio NPT

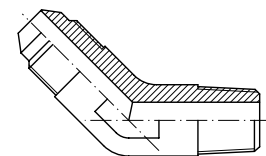

PIPE TUBO		THREAD ROSCA		Part n° Referencia	€
6	1/4	1/4" NPT	7/16" 20h UNF	ZS7250613	16,39
10	3/8	3/8" NPT	9/16" 18h UNF	ZS7251017	22,17
12	1/2	1/2" NPT	3/4" 16h UNF	ZS7251221	33,74
18-20	3/4	3/4" NPT	1"1/16 12h UN	ZS7252026	52,43
25	1	1" NPT	1"5/16 12h UN	ZS7252533	85,44

Racores JIC 37°

Flare fittings JIC 37°
Adaptateurs JIC 37°
Raccordi JIC 37°

TE macho - macho - macho JIC 37°

Union tee male JIC 37°

Té égaux mâle JIC 37°

Adattatore a T maschio JIC 37°

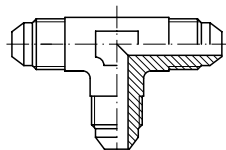

PIPE TUBO		THREAD ROSCA	Part nº Referencia	€
6	1/4	7/16" 20h UNF	ZS50506	38,74
8	5/16	1/2" 20h UNF	ZS50508	39,47
10	3/8	9/16" 18h UNF	ZS50510	38,25
12	1/2	3/4" 16h UNF	ZS50512	58,65
14-15-16	5/8	7/8" 14h UNF	ZS50516	65,14
18-20	3/4	1"1/16 12h UN	ZS50520	91,96
25	1	1"5/16 12h UN	ZS50525	131,51
30-32	1 1/4	1"5/8 12h UN	ZS50532	194,94
38	1 1/2	1"7/8 12h UN	ZS50538	299,69

TE macho - macho - hembra giratoria JIC 37°

Tee male JIC 37° - male JIC 37° - swivel nut JIC 37°

Té mâle JIC 37° - mâle JIC 37° - femelle tournante JIC 37° au latéral

Adattatore a T maschio - maschio - femmina girevole JIC 37°

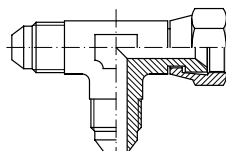

PIPE TUBO		THREAD ROSCA	Part nº Referencia	€
6	1/4	7/16" 20h UNF	ZS68006	43,16
8	5/16	1/2" 20h UNF	ZS68008	44,68
10	3/8	9/16" 18h UNF	ZS68010	40,80
12	1/2	3/4" 16h UNF	ZS68012	59,52
14-15-16	5/8	7/8" 14h UNF	ZS68016	69,34
18-20	3/4	1"1/16 12h UN	ZS68020	93,67
25	1	1"5/16 12h UN	ZS68025	150,29
32	1 1/4	1"5/8 12h UN	ZS68032	208,21
38	1 1/2	1"7/8 12h UN	ZS68038	277,86

TE macho - macho - macho JIC 37° con junta

Union tee male JIC 37° with o'ring

Té égaux mâle JIC 37° avec o'ring

Adattatore a T maschio JIC 37° con o'ring

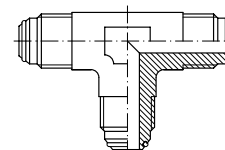

PIPE TUBO		THREAD ROSCA	Part nº Referencia	€
6	1/4	7/16" 20h UNF	ZS50506OR	55,15
8	5/16	1/2" 20h UNF	ZS50508OR	50,85
10	3/8	9/16" 18h UNF	ZS50510OR	56,39
12	1/2	3/4" 16h UNF	ZS50512OR	66,93
14-15-16	5/8	7/8" 14h UNF	ZS50516OR	82,08
18-20	3/4	1"1/16 12h UN	ZS50520OR	114,67
25	1	1"5/16 12h UN	ZS50525OR	172,12
30-32	1 1/4	1"5/8 12h UN	ZS50532OR	214,22
38	1 1/2	1"7/8 12h UN	ZS50538OR	327,37

TE macho - hembra giratoria - macho JIC 37°

Tee male JIC 37° - swivel nut JIC 37° - male JIC 37°

Té mâle JIC 37° - femelle tournante JIC 37° - mâle JIC 37°

Adattatore a T maschio - femmina girevole - maschio JIC 37°

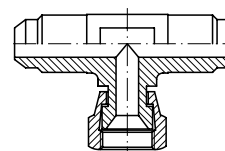

PIPE TUBO		THREAD ROSCA	Part nº Referencia	€
6	1/4	7/16" 20h UNF	ZS68506	51,61
8	5/16	1/2" 20h UNF	ZS68508	48,82
10	3/8	9/16" 18h UNF	ZS68510	46,36
12	1/2	3/4" 16h UNF	ZS68512	57,32
14-15-16	5/8	7/8" 14h UNF	ZS68516	70,55
18-20	3/4	1"1/16 12h UN	ZS68520	85,14
25	1	1"5/16 12h UN	ZS68525	166,84
32	1 1/4	1"5/8 12h UN	ZS68532	199,19
38	1 1/2	1"7/8 12h UN	ZS68538	267,17

TES macho JIC 37° - macho JIC 37° - macho NPT

Tee male JIC 37° - male JIC 37° - male NPT

Tés mâle JIC 37° - mâle JIC 37° - mâle NPT

Adattatore a T maschio JIC 37° - maschio JIC 37° - maschio NPT

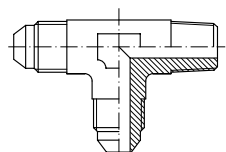

THREAD ROSCA			Part nº Referencia	€
7/16"-20h UNF	7/16"-20h UNF	1/8" NPT	ZS6300610	32,25
1/2"-20h UNF	1/2"-20h UNF	1/4" NPT	ZS6300813	43,42
9/16"-18h UNF	9/16"-18h UNF	1/4" NPT	ZS6301013	52,24
3/4"-16h UNF	3/4"-16h UNF	3/8" NPT	ZS6301217	59,07
7/8"-14h UNF	7/8"-14h UNF	1/2" NPT	ZS6301621	70,25
1"1/16-12h UN	1"1/16-12h UN	3/4" NPT	ZS6302026	97,34
1"5/16-12h UN	1"5/16-12h UN	1" NPT	ZS6302533	116,60

TES macho JIC 37° - macho NPT - macho JIC 37°

Tee male JIC 37° - male NPT - male JIC 37°

Tés mâle JIC 37° - mâle NPT - mâle JIC 37°

Adattatore a T maschio JIC 37° - maschio NPT - maschio JIC 37°

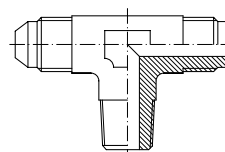

THREAD ROSCA			Part nº Referencia	€
7/16"-20h UNF	1/8" NPT	7/16"-20h UNF	ZS6250610	32,25
1/2"-20h UNF	1/4" NPT	1/2"-20h UNF	ZS6250813	45,16
9/16"-18h UNF	1/4" NPT	9/16"-18h UNF	ZS6251013	50,23
3/4"-16h UNF	3/8" NPT	3/4"-16h UNF	ZS6251217	59,07
7/8"-14h UNF	1/2" NPT	7/8"-14h UNF	ZS6251621	70,25
1"1/16-12h UN	3/4" NPT	1"1/16-12h UN	ZS6252026	97,34
1"5/16-12h UN	1" NPT	1"5/16-12h UN	ZS6252533	116,60

Conducción rígida II

Pipe fittings II

Raccord tube rigide II

Raccordi ad anello II

Tubo TrΔle SCH

SCH TrΔle Rigid pipe
Tube rigide TrΔle SCH
Tubo rigido TrΔle SCH

128

Racores SCH

SCH fittings
Embouts SCH
Raccordi SCH

129

Bridas SAE

SAE Flanges
Brides SAE
Flange SAE

132

Abrazaderas TrΔle

TrΔle Clamps
Colliers TrΔle
Collari fissatubo TrΔle

139

3

Tubo TrΔle SCH

SCH TrΔle Rigid pipe

Tube rigide TrΔle SCH

Tubo rigido TrΔle SCH

- Tubo SCH10 /Schedule 10 /Schedule 10 /Schedule 10

| 128



ZTH10



ZTH10...-3

- Tubo SCH40 /Schedule 40 /Schedule 40 /Schedule 40

| 128



ZTH40



ZTH40...-3

Racores SCH

SCH fittings
 Embouts SCH
 Raccordi SCH

■ Racores Tubo SCH /SCH Pipe Fittings /Raccords SCH /Raccordi SCH

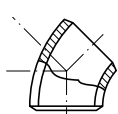

ZS4510

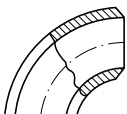

ZS9010

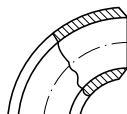

ZS90R10

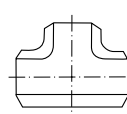

ZST100

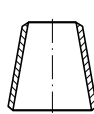

ZSR100

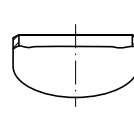

ZSC100

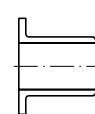

ZSTUB10

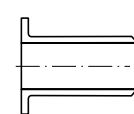

ZSTUBL40

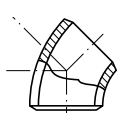

ZS4540

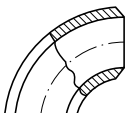

ZS9040

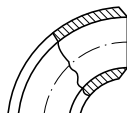

ZS90R40

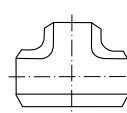

ZST400

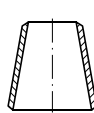

ZSR400

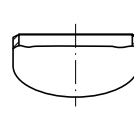

ZSC400

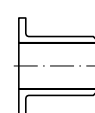

ZSTUB40

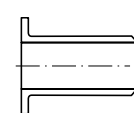

ZSTUBL10

Crimping fittings for hoses

Pipe fittings

Pipe fittings II

Adaptors

Welding fittings

Industrial fittings

Accessories

Control components

Flow measuring

Tr/Me LOK

Bridas SAE

SAE Flanges
Brides SAE
Flange SAE

- Bridas roscadas / Threaded flanges / Brides taraudées / Flange filettate | 132

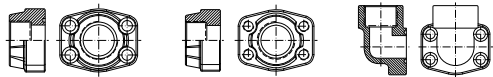

ZBBRG

ZBCRG

ZB90RG

- Bridas soldables tubo Gas / Welding flanges for gas tube / Brides à souder pour tube gaz / Flange a saldare per tubo gas | 133

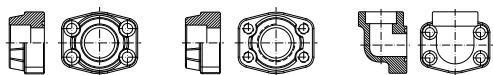

ZBBSG

ZBCSG

ZB90SG

- Bridas soldables tubo Métrico / Welding flanges for metric tube / Brides à souder pour tube métrique / Flange a saldare per tubo Metrico | 134

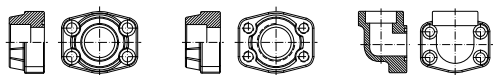

ZBBSM

ZBCSM

ZB90SM

- Bridas ciegas / Blind flanges / Brides avec obturateur fermé / Flange cieche | 135

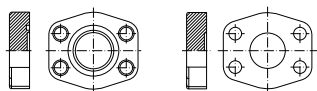

ZBBC

ZBCC

- Bridas para flexibles / SAE Flanges for hoses / Brides SAE pour flexibles / Flange SAE per tubi flessibili | 136

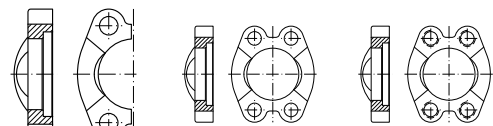

ZBBP

ZBBE

ZBCE

- Conos soldar / Welding adaptors for flanges / Collets à souder / Ogive a saldare | 137

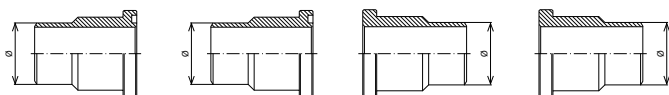

ZBSM*1

ZBSG*1

ZBSM*0

ZBSG*0

- Accesorios bridas / Flange accessories / Accessoires pour brides / Accessori flangia | 138



ZTB

JBR

ORING

Abrazaderas TrΔle

TrΔle Clamps
Colliers TrΔle
Collari fissatubo TrΔle

- Abrazaderas completas serie ligera / Complete clamps light serie / Colliers complets série légère / Collari fissatubo completo serie leggera | 139

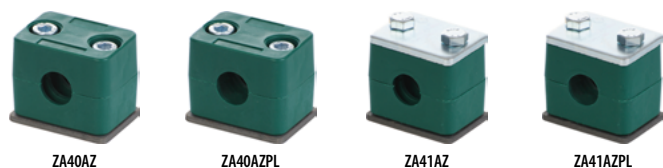

- Componentes abrazaderas serie ligera / Components for clamps light serie / Composants pour colliers série légère / Componenti per collari fissatubo serie leggera | 140



- Dobles / paralelas / Double clamp - parallel / Colliers de fixation doubles / Collari fissatubo doppi | 141



- Abrazaderas serie pesada / Clamps heavy serie / Colliers série lourde / Collari fissatubo serie pesante | 142

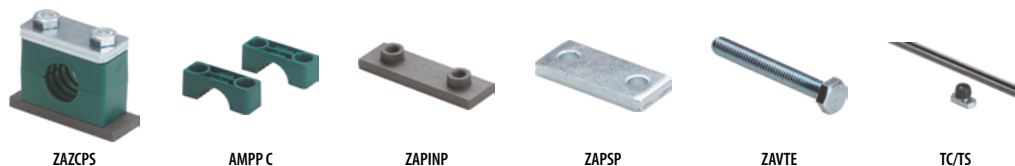

Tubo TrΔle SCH

SCH TrΔle Rigid pipe
Tube rigide TrΔle SCH
Tubo rigido TrΔle SCH

Tubo rígido SCH10 - AISI 316 - 6 METROS

SCH 10 rigid pipe - 6 metres- AISI 316

Tube rigide SCH10 - 6 metres- AISI 316



Tubo rígido SCH10 - AISI 316 - 6 metri

Ø OUTER Ø EXT.	WP (bar) PRESIÓN TRABAJO (bar)	KG/M	Thickness (mm) Espesor (mm)	Part nº Referencia	€
21.3	261	1	2.11	ZTH10SC008	35,38
26.7	205	1.28	2.11	ZTH10SC012	43,03
33.4	216	2.09	2.77	ZTH10SC016	67,78
42.2	168	2.7	2.77	ZTH10SC020	86,20
48.3	146	3.11	2.77	ZTH10SC024	99,26
60.3	116	3.93	2.77	ZTH10SC032	124,67

Tubo rígido SCH10 - AISI 316 - 3 METROS

SCH 10 rigid pipe - 3 meters - AISI 316

Tube rigide SCH10 - 3 metres - AISI 316



Tubo rígido SCH10 - AISI 316 - 3 metri

Ø OUTER Ø EXT.	WP (bar) PRESIÓN TRABAJO (bar)	Thickness (mm) Espesor (mm)	Part nº Referencia	€
21.3	261	2.11	ZTH10SC008-3	37,89
26.7	205	2.11	ZTH10SC012-3	46,08
33.4	216	2.77	ZTH10SC016-3	72,59
42.2	168	2.77	ZTH10SC020-3	92,32
48.3	146	2.77	ZTH10SC024-3	106,30
60.3	116	2.77	ZTH10SC032-3	133,52

Tubo rígido SCH40 - AISI 316 - 6 METROS

SCH 40 rigid pipe - 6 metres - AISI 316

Tube rigide SCH40 - 6 metres - AISI 316



Tubo rígido SCH40 - AISI 316 - 6 metri

Ø OUTER Ø EXT.	WP (bar) PRESIÓN TRABAJO (bar)	KG/M	Thickness (mm) Espesor (mm)	Part nº Referencia	€
21.3	354	1.27	2.77	ZTH40SC008	39,92
26.7	287	1.69	2.87	ZTH40SC012	52,69
33.4	268	2.5	3.38	ZTH40SC016	66,04
42.2	220	3.39	3.56	ZTH40SC020	88,36
48.3	197	4.05	3.68	ZTH40SC024	108,39
60.3	166	5.44	3.91	ZTH40SC032	145,56

Tubo rígido SCH40 - AISI 316 - 3 METROS

SCH 40 rigid pipe - 3 metres - AISI 316

Tube rigide SCH40 - 3 metres - AISI 316



Tubo rígido SCH40 - AISI 316 - 3 metri

Ø OUTER Ø EXT.	WP (bar) PRESIÓN TRABAJO (bar)	Thickness (mm) Espesor (mm)	Part nº Referencia	€
21.3	354	2.77	ZTH40SC008-3	42,76
26.7	287	2.87	ZTH40SC012-3	56,43
33.4	268	3.38	ZTH40SC016-3	70,73
42.2	220	3.56	ZTH40SC020-3	94,63
48.3	197	3.68	ZTH40SC024-3	116,08
60.3	166	3.91	ZTH40SC032-3	155,90



AMPLIA GAMA TUBO RÍGIDO

SCHEDULE

MÉTRICO

STANDARD

CROMO III



INOXIDABLE
STAINLESS-STEEL

CARBONO
CARBON-STEEL

SELECT YOUR
PIPE TYPE

Racores SCH

SCH fittings
Embouts SCH
Raccordi SCH

Crimping fittings for hoses

Pipe fittings

Pipe fittings II

Adaptors

Welding fittings

Industrial fittings

Accessories

Control components

Flow measuring

Tri/Le LOK

Codo 45 SCH10

Elbow 45 Sch10

Coude 45 Sch10

Gomito 45 per Sch10

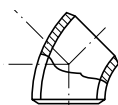

DN	Part nº Referencia	€
1/2"	ZS4510008	*
3/4"	ZS4510012	*
1"	ZS4510016	*
1" 1/4	ZS4510020	*
1" 1/2	ZS4510024	*
2"	ZS4510032	*

Codo 90 SCH10

Elbow 90 Sch10

Coude 90 Sch10

Gomito 90 per Sch10

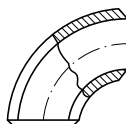

DN	Part nº Referencia	€
1/2"	ZS9010008	*
3/4"	ZS9010012	*
1"	ZS9010016	*
1" 1/4	ZS9010020	*
1" 1/2	ZS9010024	*
2"	ZS9010032	*

Codo 90 SCH10 Reducido

Elbow 90 Sch10 Reduced

Coude 90 Réduit Sch10

Ridotto 90 gomiti Sch10

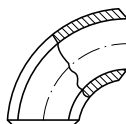

DN	Part nº Referencia	€
1"	ZS90R10016	*
1" 1/4	ZS90R10020	*
1" 1/2	ZS90R10024	*
2"	ZS90R10032	*

Te SCH10

Tee Sch10

Té Sch10

Raccordo Sch10

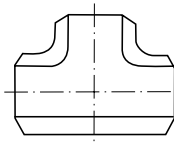

DN	Part nº Referencia	€
1/2"	ZST10008	*
3/4"	ZST10012	*
1"	ZST10016	*
1" 1/4	ZST10020	*
1" 1/2	ZST10024	*
2"	ZST10032	*

Reducción SCH10

Reduction Sch10

Réduit Sch10

Riduzione Sch10



DN	Part nº Referencia	€
3/4" - 1/2"	ZSR10012008	*
1" - 3/4"	ZSR10016012	*
1" 1/4 - 3/4"	ZSR10020012	*
1" 1/2 - 1" 1/4	ZSR10024020	*
2" - 1" 1/2	ZSR10032024	*

Tapón SCH10

Plug Sch10

Bouchon Sch 10

Tappo Sch10

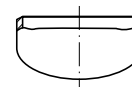

DN	Part nº Referencia	€
1/2"	ZSC10008	*
3/4"	ZSC10012	*
1"	ZSC10016	*
1" 1/4	ZSC10020	*
1" 1/2	ZSC10024	*
2"	ZSC10032	*

Stub End SCH10

Stub End Sch10

Embout Sch 10

Estremità stub Sch10

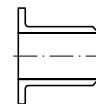

DN	Part nº Referencia	€
1/2"	ZSTUB1008	*
3/4"	ZSTUB1012	*
1"	ZSTUB1016	*
1" 1/4	ZSTUB1020	*
1" 1/2	ZSTUB1024	*
2"	ZSTUB1032	*

Stub End Largo Inox SCH10

Long Stub End Sch10

Embout long Sch10

Lunga estremità Sch10

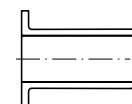

DN	Part nº Referencia	€
1/2"	ZSTUBL1008	*
3/4"	ZSTUBL1012	*
1"	ZSTUBL1016	*
1" 1/4	ZSTUBL1020	*
1" 1/2	ZSTUBL1024	*
2"	ZSTUBL1032	*

Racores SCH

SCH fittings
Embouts SCH
Raccordi SCH

Codo 45 SCH40

Elbow 45 Sch40

Coude 45 Sch40

Gomito 45 per Sch40

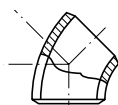

DN	Part nº Referencia	€
1/2"	ZS4540008	*
3/4"	ZS4540012	*
1"	ZS4540016	*
1" 1/4	ZS4540020	*
1" 1/2	ZS4540024	*
2"	ZS4540032	*

Codo 90 SCH40

Elbow 90 Sch40

Coude 90 Sch40

Gomito 90 per Sch40

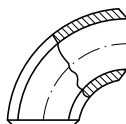

DN	Part nº Referencia	€
1/2"	ZS9040008	*
3/4"	ZS9040012	*
1"	ZS9040016	*
1" 1/4	ZS9040020	*
1" 1/2	ZS9040024	*
2"	ZS9040032	*

Codo 90 Inox SCH40 Reducido

Elbow 90 Sch40 Reduced

Coude 90 Réduit Sch40

Ridotto 90 gomiti Sch40

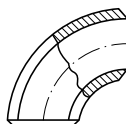

DN	Part nº Referencia	€
1"	ZS90R40016	*
1" 1/4	ZS90R40020	*
1" 1/2	ZS90R40024	*
2"	ZS90R40032	*

Te Inox SCH40

Tee Sch40

Té Sch40

Raccordo Sch40

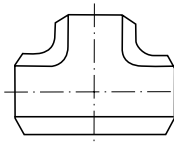

DN	Part nº Referencia	€
1/2"	ZST40008	*
3/4"	ZST40012	*
1"	ZST40016	*
1" 1/4	ZST40020	*
1" 1/2	ZST40024	*
2"	ZST40032	*

Reducción Inox SCH40

Reduction Sch40

Réduction Sch40

Riduzione Sch40



DN	Part nº Referencia	€
3/4" - 1/2"	ZSR40012008	*
1" - 3/4"	ZSR40016012	*
1" 1/4 - 3/4"	ZSR40020012	*
1" 1/2 - 1" 1/4	ZSR40024020	*
2" - 1" 1/2"	ZSR40032024	*

Tapón Inox SCH40

Plug Sch40

Bouchon Sch40

Tappo Sch40

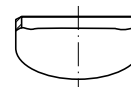

DN	Part nº Referencia	€
1/2"	ZSC40008	*
3/4"	ZSC40012	*
1"	ZSC40016	*
1" 1/4	ZSC40020	*
1" 1/2	ZSC40024	*
2"	ZSC40032	*

Stub End Inox SCH40

Stub End Sch40

Embout Sch40

Estremità stub Acciaio Sch40

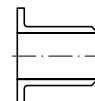

DN	Part nº Referencia	€
1/2"	ZSTUB4008	*
3/4"	ZSTUB4012	*
1"	ZSTUB4016	*
1" 1/4	ZSTUB4020	*
1" 1/2	ZSTUB4024	*
2"	ZSTUB4032	*

Stub End Largo Inox SCH40

Long Stub End Sch40

Embout long Sch40

Lunga estremità Sch40

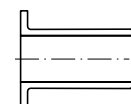

DN	Part nº Referencia	€
1/2"	ZSTUBL4008	*
3/4"	ZSTUBL4012	*
1"	ZSTUBL4016	*
1" 1/4	ZSTUBL4020	*
1" 1/2	ZSTUBL4024	*
2"	ZSTUBL4032	*

BAE flanges

Brides SAE
Bridges SAE
Flangia SAE

Characteristics

Caratteristiche
Données communes
Caratteristiche comuni

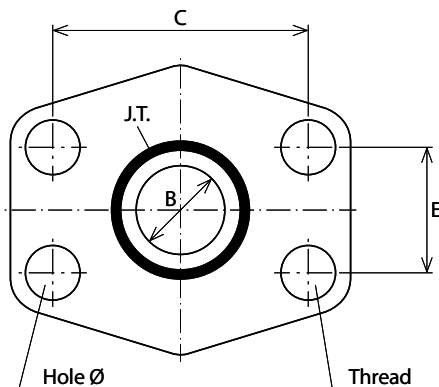

Bridges 3000 PSI

Bridges 3000 PSI
Bridges 3000 PSI
Flangia 3000 PSI

Tamaño Size Taille Misura	Max. pre. Max. pre. Max. pre.	B	C	E	O'ring NBR O'ring NBR O'ring NBR	Junta PU PU seal Joint PU Guarnizione in PU	Ø	Tornillo * Screw * Vis * Vite *	Rosca Thread Filetage Filetto
1/2"	345 bar	13	38,1	17,48	18,64 x 3,53	JBR08	9	TB8X30	M8
3/4"	345 bar	19	47,63	22,23	24,99 x 3,53	JBR12	11	TB10X35	M10
1"	345 bar	25	52,37	26,19	32,92 x 3,53	JBR16	11	TB10X35	M10
1 1/4"	276 bar	32	58,72	30,18	37,70 x 3,53	JBR20	11,5	TB10X40	M10
1 1/2"	207 bar	38	69,85	35,71	47,22 x 3,53	JBR24	13,5	TB12X45	M12
2"	207 bar	51	77,77	42,88	56,74 x 3,53	JBR32	13,5	TB12X45	M12
2 1/2"	172 bar	63	88,9	50,8	66,27 x 3,53		13,5	TB12X45	M12
3"	138 bar	73	106,38	61,93	85,32 x 3,53		17,5	TB16X50	M16
3 1/2"	34 bar	89	120,65	69,85	98,02 x 3,53		17,5	TB16X50	M16
4"	34 bar	99	130,18	77,77	110,72 x 3,53		17,5	TB16X50	M16

Bridges 6000 PSI

Flanges 6000 PSI
Bridges 6000 PSI
Flangia 6000 PSI

Tamaño Size Taille Misura	Max. pre. Max. pre. Max. pre.	B	C	E	O'ring NBR O'ring NBR O'ring NBR	Junta PU PU seal Joint PU Guarnizione PU	Ø	Tornillo * Screw * Vis * Vite *	Rosca Thread Filetage Filetto
1/2"	414 bar	13	40,49	18,24	18,64 x 3,53	JBR08	9	TB8X30	M8
3/4"	414 bar	19	50,8	23,8	24,99 x 3,53	JBR12	11	TB10X40	M10
1"	414 bar	25	57,15	27,76	32,92 x 3,53	JBR16	13	TB12X45	M12
1 1/4"	414 bar	32	66,68	31,75	37,70 x 3,53	JBR20	15	TB14X45	M14
1 1/2"	414 bar	38	79,38	36,5	47,22 x 3,53	JBR24	17	TB16X50	M16
2"	414 bar	51	98,82	44,45	56,74 x 3,53	JBR32	21	TB20X70	M20

* Screws are carbon steel. For stainless steel screws, please refer to ZTB number.

Les vis sont en acier carbone. Pour vis en acier inoxydable, veuillez demander les références ZTB ...
Le viti sono in acciaio al carbonio. Per viti in acciaio inox, ordinare con codice ZTB...

Bridas SAE

SAE Flanges
Brides SAE
Flange SAE

Brida roscada hembra BSP

BSP Female threaded flange

Bride taraudée femelle BSP

Flangia filettata femmina BSP

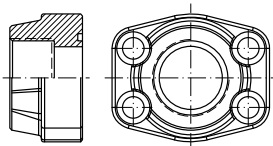

SERIE	THREAD ROSCA	SIZE TAMAÑO	Part nº Referencia	€
3000 PSI	1/2" BSP	1/2"	ZBBRG30808	23,33
3000 PSI	3/4" BSP	3/4"	ZBBRG31212	29,49
3000 PSI	1" BSP	1"	ZBBRG31616	36,84
3000 PSI	1"1/4 BSP	1"1/4	ZBBRG32020	46,60
3000 PSI	1"1/2 BSP	1"1/2	ZBBRG32424	67,82
3000 PSI	2" BSP	2"	ZBBRG33232	87,42
3000 PSI	2"1/2 BSP	2"1/2	ZBBRG34040	123,29
3000 PSI	3" BSP	3"	ZBBRG34848	166,82
3000 PSI	3"1/2 BSP	3"1/2	ZBBRG35656	642,60
3000 PSI	4" BSP	4"	ZBBRG36464	681,08
6000 PSI	1/2" BSP	1/2"	ZBBRG60808	24,58
6000 PSI	3/4" BSP	3/4"	ZBBRG61212	34,35
6000 PSI	1" BSP	1"	ZBBRG61616	49,09
6000 PSI	1"1/4 BSP	1"1/4	ZBBRG62020	66,27
6000 PSI	1"1/2 BSP	1"1/2	ZBBRG62424	93,83
6000 PSI	2" BSP	2"	ZBBRG63232	168,06

Contrabrida roscada hembra BSP

BSP Female threaded counter-flange

Contre-bride taraudée femelle BSP

Controflangia filettata femmina BSP

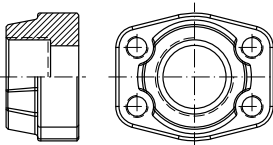

SERIE	THREAD ROSCA	SIZE TAMAÑO	Part nº Referencia	€
3000 PSI	1/2" BSP	1/2"	ZBCRG30808	23,33
3000 PSI	3/4" BSP	3/4"	ZBCRG31212	29,49
3000 PSI	1" BSP	1"	ZBCRG31616	36,84
3000 PSI	1"1/4 BSP	1"1/4	ZBCRG32020	46,60
3000 PSI	1"1/2 BSP	1"1/2	ZBCRG32424	73,42
3000 PSI	2" BSP	2"	ZBCRG33232	87,42
3000 PSI	2"1/2 BSP	2"1/2	ZBCRG34040	123,01
3000 PSI	3" BSP	3"	ZBCRG34848	166,82
3000 PSI	3"1/2 BSP	3"1/2	ZBCRG35656	630,00
3000 PSI	4" BSP	4"	ZBCRG36464	681,08
6000 PSI	1/2" BSP	1/2"	ZBCRG60808	24,58
6000 PSI	3/4" BSP	3/4"	ZBCRG61212	34,35
6000 PSI	1" BSP	1"	ZBCRG61616	49,09
6000 PSI	1"1/4 BSP	1"1/4	ZBCRG62020	66,27
6000 PSI	1"1/2 BSP	1"1/2	ZBCRG62424	93,83
6000 PSI	2" BSP	2"	ZBCRG63232	168,06

Brida codo 90° roscada hembra BSP

90° BSP female threaded flange

Bride 90° taraudée femelle BSP

Flangia a 90° filettata femmina BSP

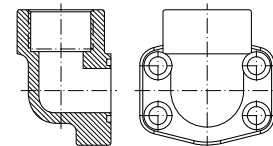

SERIE	THREAD ROSCA	SIZE TAMAÑO	Part nº Referencia	€
3000 PSI	1/2" BSP	1/2"	ZB90RG30808	123,94
3000 PSI	3/4" BSP	3/4"	ZB90RG31212	148,42
3000 PSI	1" BSP	1"	ZB90RG31616	177,19
3000 PSI	1"1/4 BSP	1"1/4	ZB90RG32020	212,68
3000 PSI	1"1/2 BSP	1"1/2	ZB90RG32424	415,45
3000 PSI	2" BSP	2"	ZB90RG33232	544,87
6000 PSI	1/2" BSP	1/2"	ZB90RG60808	123,94
6000 PSI	3/4" BSP	3/4"	ZB90RG61212	177,19
6000 PSI	1" BSP	1"	ZB90RG61616	212,68
6000 PSI	1"1/4 BSP	1"1/4	ZB90RG62020	290,72
6000 PSI	1"1/2 BSP	1"1/2	ZB90RG62424	382,53

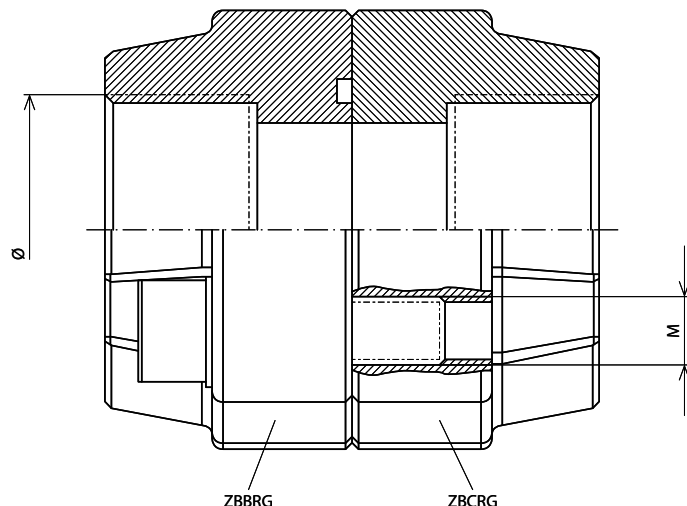

Bridas SAE

SAE Flanges
Brides SAE
Flange SAE

Brida soldable hembra tubo gas

Welding female flange for gas tube

Bride à souder femelle tube gaz

Flangia femmina a saldare per tubo gas

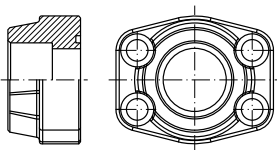

SERIE	Ø INNER Ø INT.	SIZE TAMAÑO	Part nº Referencia	€
3000 PSI	21.6	1/2"	ZBBSG308216	23,33
3000 PSI	27.2	3/4"	ZBBSG312272	29,49
3000 PSI	34.0	1"	ZBBSG316340	36,84
3000 PSI	42.8	1"1/4	ZBBSG320428	46,60
3000 PSI	48.6	1"1/2	ZBBSG324486	73,61
3000 PSI	61.0	2"	ZBBSG332610	95,70
3000 PSI	76.6	2"1/2	ZBBSG340766	134,96
3000 PSI	90.5	3"	ZBBSG348905	166,82
3000 PSI	103.0	3"1/2	ZBBSG3561030	595,94
3000 PSI	115.5	4"	ZBBSG3641155	647,02
6000 PSI	21.6	1/2"	ZBBSG608216	24,58
6000 PSI	27.2	3/4"	ZBBSG612272	34,35
6000 PSI	34.0	1"	ZBBSG616340	49,09
6000 PSI	42.8	1"1/4	ZBBSG620428	66,27
6000 PSI	48.6	1"1/2	ZBBSG624486	93,83
6000 PSI	61.0	2"	ZBBSG632610	168,06

Contrabrida soldable hembra tubo gas

Welding female counter-flange for gas tube

Contre-bride à souder femelle tube gaz

Controflangia femmina a saldare per tubo gas

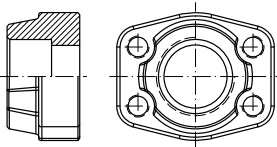

SERIE	Ø INNER Ø INT.	SIZE TAMAÑO	Part nº Referencia	€
3000 PSI	21.6	1/2"	ZBCSG308216	23,33
3000 PSI	27.2	3/4"	ZBCSG312272	29,49
3000 PSI	34.0	1"	ZBCSG316340	36,84
3000 PSI	42.8	1"1/4	ZBCSG320428	46,60
3000 PSI	48.6	1"1/2	ZBCSG324486	73,61
3000 PSI	61.0	2"	ZBCSG332610	95,70
3000 PSI	76.6	2"1/2	ZBCSG340766	134,96
3000 PSI	90.5	3"	ZBCSG348905	166,82
3000 PSI	103.0	3"1/2	ZBCSG3561030	595,94
3000 PSI	115.5	4"	ZBCSG3641155	647,02
6000 PSI	21.6	1/2"	ZBCSG608216	24,58
6000 PSI	27.2	3/4"	ZBCSG612272	34,35
6000 PSI	34.0	1"	ZBCSG616340	49,09
6000 PSI	42.8	1"1/4	ZBCSG620428	66,27
6000 PSI	48.6	1"1/2	ZBCSG624486	93,83
6000 PSI	61.0	2"	ZBCSG632610	168,06

Brida codo 90° soldable hembra tubo gas

90° welding female flange for gas tube

Bride 90° à souder femelle tube gaz

Flangia a 90° femmina a saldare per tubo gas

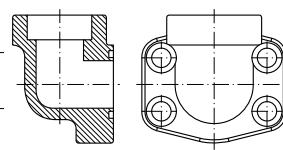

SERIE	Ø INNER Ø INT.	SIZE TAMAÑO	Part nº Referencia	€
3000 PSI	21.6	1/2"	ZB90SG308216	132,61
3000 PSI	27.2	3/4"	ZB90SG312272	143,83
3000 PSI	34.0	1"	ZB90SG316340	171,98
3000 PSI	42.8	1"1/4	ZB90SG320428	206,87
3000 PSI	48.6	1"1/2	ZB90SG324486	284,90
3000 PSI	61.0	2"	ZB90SG332610	374,87
6000 PSI	21.6	1/2"	ZB90SG608216	119,35
6000 PSI	27.2	3/4"	ZB90SG612272	204,30
6000 PSI	34.0	1"	ZB90SG616340	206,87
6000 PSI	42.8	1"1/4	ZB90SG620428	284,90
6000 PSI	48.6	1"1/2	ZB90SG624486	374,87

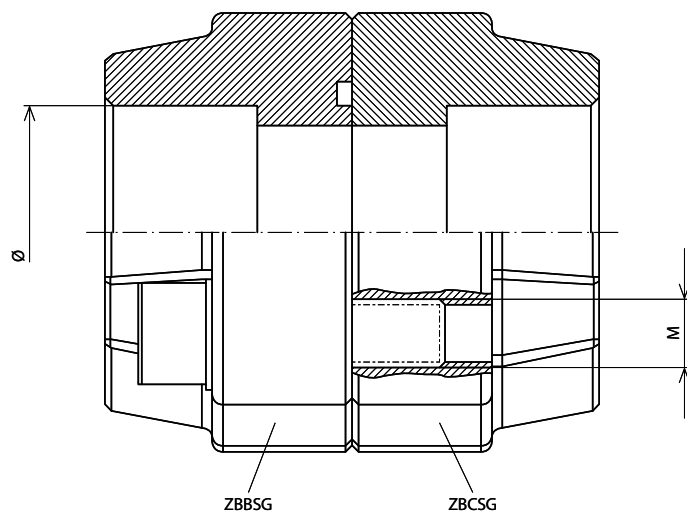

Bridas SAE

SAE Flanges
Brides SAE
Flange SAE

Brida soldable hembra tubo métrico

Female welding flange for metric tube

Bride à souder femelle tube métrique

Flangia femmina a saldare per tubo Metrico

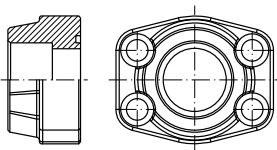

SERIE	Ø INNER Ø INT.	SIZE TAMAÑO	Part nº Referencia	€
3000 PSI	20.3	1/2"	ZBBSM308203	*
3000 PSI	25.3	3/4"	ZBBSM312253	*
3000 PSI	30.3	1"	ZBBSM316303	*
3000 PSI	38.3	1"1/4	ZBBSM320383	*
3000 PSI	50.5	1"1/2	ZBBSM324505	*
6000 PSI	20.3	1/2"	ZBBSM608203	*
6000 PSI	25.3	3/4"	ZBBSM612253	*
6000 PSI	30.3	1"	ZBBSM616303	*
6000 PSI	38.3	1"1/4	ZBBSM620383	*
6000 PSI	50.5	1"1/2	ZBBSM624505	*

Contrabrida soldable hembra tubo métrico

Female welding counter-flange for metric tube

Contre-bride à souder femelle tube métrique

Controflangia femmina a saldare per tubo Metrico

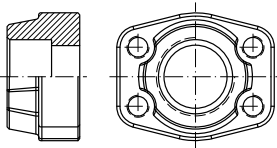

SERIE	Ø INNER Ø INT.	SIZE TAMAÑO	Part nº Referencia	€
3000 PSI	20.3	1/2"	ZBCSM308203	*
3000 PSI	25.3	3/4"	ZBCSM312253	*
3000 PSI	30.3	1"	ZBCSM316303	*
3000 PSI	38.3	1"1/4	ZBCSM320383	*
3000 PSI	50.5	1"1/2	ZBCSM324505	*
6000 PSI	20.3	1/2"	ZBCSM608203	*
6000 PSI	25.3	3/4"	ZBCSM612253	*
6000 PSI	30.3	1"	ZBCSM616303	*
6000 PSI	38.3	1"1/4	ZBCSM620383	*
6000 PSI	50.5	1"1/2	ZBCSM624505	*

Brida codo 90° soldable Hembra tubo métrico

90° female welding flange for metric tube

Bride 90° à souder femelle tube métrique

Flangia a 90° femmina a saldare per tubo Metrico

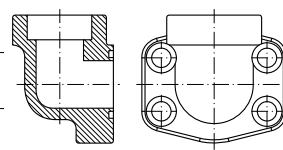

SERIE	Ø INNER Ø INT.	SIZE TAMAÑO	Part nº Referencia	€
3000 PSI	20.3	1/2"	ZB90SM308203	*
3000 PSI	25.3	3/4"	ZB90SM312253	*
3000 PSI	30.3	1"	ZB90SM316303	*
3000 PSI	38.3	1"1/4	ZB90SM320383	*
3000 PSI	50.5	1"1/2	ZB90SM324505	*
6000 PSI	20.3	1/2"	ZB90SM608203	*
6000 PSI	25.3	3/4"	ZB90SM612253	*
6000 PSI	30.3	1"	ZB90SM616303	*
6000 PSI	38.3	1"1/4	ZB90SM620383	*
6000 PSI	50.5	1"1/2	ZB90SM624505	*

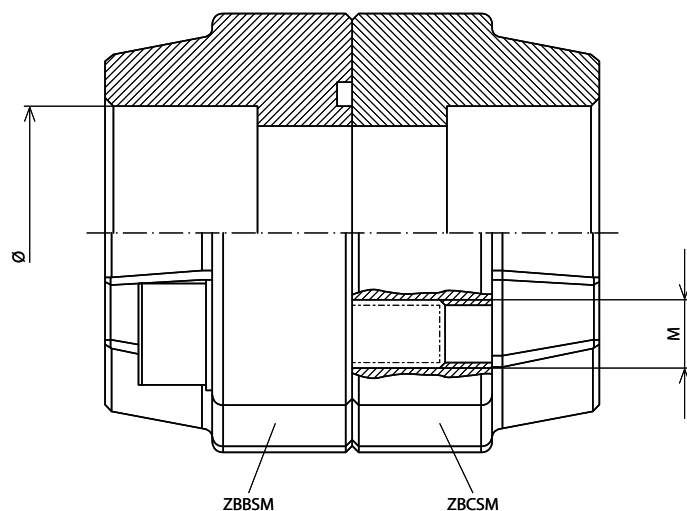

Bridas SAE

SAE Flanges
Brides SAE
Flange SAE

Crimping fittings for hoses

Pipe fittings

Pipe fittings II

Adaptors

Welding fittings

Industrial fittings

Accessories

Control components

Flow measuring

Tr/Mc LOK

Bridas ciegas

Blind flanges

Brides avec obturateur fermé

Flange cieche

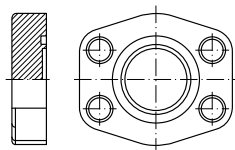

SERIE	SIZE TAMANO	Part nº Referencia	€
3000 PSI	1/2"	ZBBC308	71,00
3000 PSI	3/4"	ZBBC312	86,88
3000 PSI	1"	ZBBC316	102,15
3000 PSI	1"1/4	ZBBC320	119,20
3000 PSI	1"1/2	ZBBC324	153,26
3000 PSI	2"	ZBBC332	177,09
3000 PSI	2"1/2	ZBBC340	204,33
3000 PSI	3"	ZBBC348	289,46
3000 PSI	3"1/2	ZBBC356	374,60
3000 PSI	4"	ZBBC364	442,69
6000 PSI	1/2"	ZBBC608	76,02
6000 PSI	3/4"	ZBBC612	102,15
6000 PSI	1"	ZBBC616	129,42
6000 PSI	1"1/4	ZBBC620	183,89
6000 PSI	1"1/2	ZBBC624	289,46
6000 PSI	2"	ZBBC632	425,67

Contrabridas ciegas

Blind counter-flanges

Contre-brides avec obturateur fermé

Controflange cieche

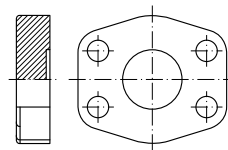

SERIE	SIZE TAMANO	Part nº Referencia	€
3000 PSI	1/2"	ZBCC308	79,99
3000 PSI	3/4"	ZBCC312	91,47
3000 PSI	1"	ZBCC316	112,37
3000 PSI	1"1/4	ZBCC320	131,10
3000 PSI	1"1/2	ZBCC324	168,56
3000 PSI	2"	ZBCC332	194,78
3000 PSI	3"	ZBCC348	318,41
3000 PSI	3"1/2	ZBCC356	412,06
3000 PSI	4"	ZBCC364	486,97
6000 PSI	1/2"	ZBCC608	92,35
6000 PSI	3/4"	ZBCC612	112,37
6000 PSI	1"	ZBCC616	142,36
6000 PSI	1"1/4	ZBCC620	202,28
6000 PSI	1"1/2	ZBCC624	318,41
6000 PSI	2"	ZBCC632	468,24

Bridas soldables macho

Bridas soldables macho

Brides à souder mâle

Flangia a saldare maschio

■ Brida soldable macho de tubo gasabe

Bride soldable macho de tubo gasabe

Bride à souder mâle tube gaz

Flangia a saldare maschio tubo gas

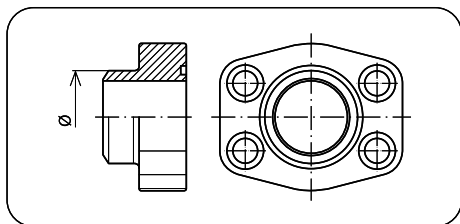

Ref: ZBMSG

■ Controflangia macho de tubo gasabe

Controflangia macho de tubo gasabe

Contre-bride à souder mâle tube gaz

Controflangia a saldare maschio tubo gas

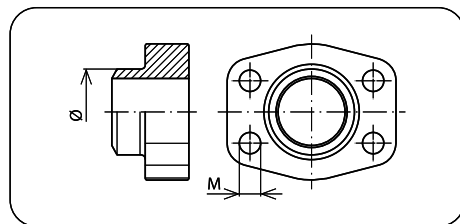

Ref: ZBCMSG

■ Brida soldable macho de tubo métrico

Bride soldable macho de tubo métrico

Bride à souder mâle tube métrique

Flangia a saldare maschio tubo metrico

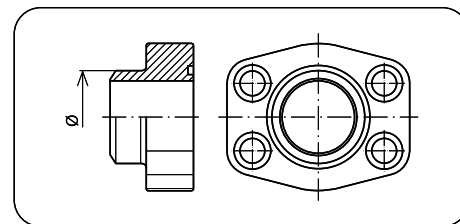

Ref: ZBMSM

■ Controflangia macho de tubo métrico

Controflangia macho de tubo métrico

Contre-bride à souder mâle tube métrique

Controflangia a saldare maschio tubo metrico

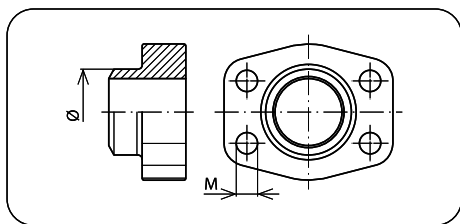

Ref: ZBCMSM

Bridas SAE

SAE Flanges
Brides SAE
Flange SAE

Brida partida pasante

SAE Split flange

Demi-bride passage total

Semiflangua SAE

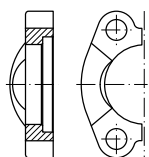

SERIE	Ø INNER Ø INT.	SIZE TAMAÑO	Part nº Referencia	€
3000 PSI	30.2	1/2"	ZBBP308302	*
3000 PSI	38.1	3/4"	ZBBP312381	*
3000 PSI	44.5	1"	ZBBP316445	*
3000 PSI	50.8	1"1/4	ZBBP320508	*
3000 PSI	60.3	1"1/2	ZBBP324603	*
3000 PSI	71.4	2"	ZBBP332714	*
3000 PSI	102.4	3"	ZBBP3481024	*
6000 PSI	31.8	1/2"	ZBBP608318	*
6000 PSI	41.3	3/4"	ZBBP612413	*
6000 PSI	47.6	1"	ZBBP616476	*
6000 PSI	54	1"1/4	ZBBP620540	*
6000 PSI	63.5	1"1/2	ZBBP624635	*
6000 PSI	79.4	2"	ZBBP632794	*

*Ver precios en p. 37 (CONEXIONES) / *See prices in p.37 (FITTINGS) / *Prix à la p.37 (EMBOUTS) / *Vedere prezzi p.37 (RACCORDI)

Brida entera pasante

SAE Flange

Bride monobloc passage total

Flangia monoblocco SAE

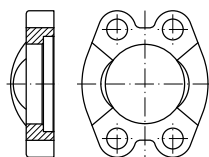

SERIE	Ø INNER Ø INT.	SIZE TAMAÑO	Part nº Referencia	€
3000 PSI	30.2	1/2"	ZBBE308302	*
3000 PSI	38.1	3/4"	ZBBE312381	*
3000 PSI	44.5	1"	ZBBE316445	*
3000 PSI	50.8	1"1/4	ZBBE320508	*
3000 PSI	60.3	1"1/2	ZBBE324603	*
3000 PSI	71.4	2"	ZBBE332714	*
6000 PSI	31.8	1/2"	ZBBE608318	*
6000 PSI	41.3	3/4"	ZBBE612413	*
6000 PSI	47.6	1"	ZBBE616476	*
6000 PSI	54	1"1/4	ZBBE620540	*
6000 PSI	63.5	1"1/2	ZBBE624635	*
6000 PSI	79.4	2"	ZBBE632794	*

*Ver precios en p. 37 (CONEXIONES) / *See prices p.37 (FITTINGS) / *Prix à la p.37 (EMBOUTS) / *Vedere prezzi p.37 (RACCORDI)

Contrabrida roscada

SAE counter-flange

Contre-bride passage total

Controflangua SAE

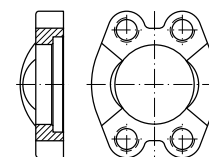

SERIE	Ø	SIZE TAMAÑO	Part nº Referencia	€
3000 PSI	30,2	1/2"	ZBCE308302	*
3000 PSI	38,1	3/4"	ZBCE312381	*
3000 PSI	44,5	1"	ZBCE316445	*
3000 PSI	50,8	1"1/4	ZBCE320508	*
3000 PSI	60,3	1"1/2	ZBCE324603	*
3000 PSI	71,4	2"	ZBCE332714	*
6000 PSI	31,8	1/2"	ZBCE608318	*
6000 PSI	41,3	3/4"	ZBCE612413	*
6000 PSI	47,6	1"	ZBCE616476	*
6000 PSI	54	1"1/4	ZBCE620540	*
6000 PSI	63,5	1"1/2	ZBCE624635	*
6000 PSI	79,4	2"	ZBCE632794	*

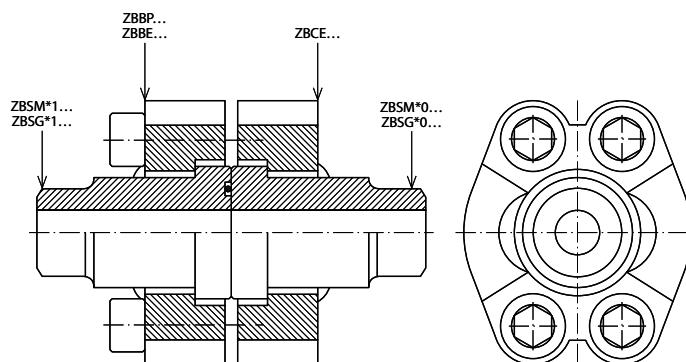

Bridas SAE

SAE Flanges
Brides SAE
Flange SAE

Crimping fittings for hoses

Pipe fittings

Pipe fittings II

Adaptors

Welding fittings

Industrial fittings

Accessories

Control components

Flow measuring

Tri/Le LOK

Brida cono soldable tubo métrico

Flange welding adaptor for metric tube

Bride collet à souder tube métrique

Adattatore a saldare per tubo Metrico con o'ring

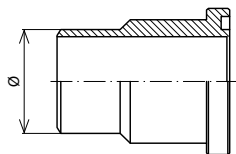

SERIE	Ø OUTER Ø EXT.	SIZE TAMAÑO	Part nº Referencia	€
3000 PSI	16	1/2"	ZBSM3108016	68,12
3000 PSI	25	3/4"	ZBSM3112025	81,74
3000 PSI	30	1"	ZBSM3116030	102,15
3000 PSI	38	1"1/4	ZBSM3120038	122,59
3000 PSI	45	1"1/2	ZBSM3124045	170,27
3000 PSI	60	2"	ZBSM3132060	204,33
3000 PSI	70	2"1/2	ZBSM3140070	272,42
3000 PSI	80	3"	ZBSM3148080	476,75
3000 PSI	100	3"1/2	ZBSM3156100	681,08
3000 PSI	114.3	4"	ZBSM3164114	817,29
6000 PSI	16	1/2"	ZBSM6108016	68,12
6000 PSI	25	3/4"	ZBSM6112025	102,15
6000 PSI	30	1"	ZBSM6116030	112,37
6000 PSI	38	1"1/4	ZBSM6120038	130,80
6000 PSI	45	1"1/2	ZBSM6124045	187,28
6000 PSI	60	2"	ZBSM6132060	224,74

Brida cono soldable tubo gas

Flange welding adaptor for gas tube

Bride collet à souder tube gaz

Adattatore a saldare per tubo gas con o'ring

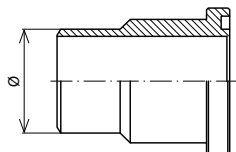

SERIE	Ø INNER Ø INT.	SIZE TAMAÑO	Part nº Referencia	€
3000 PSI	21.5	1/2"	ZBSG3108215	68,12
3000 PSI	28.0	3/4"	ZBSG3112280	81,74
3000 PSI	34.0	1"	ZBSG3116340	102,15
3000 PSI	42.8	1"1/4	ZBSG3120428	122,60
3000 PSI	48.6	1"1/2	ZBSG3124486	170,27
3000 PSI	61.0	2"	ZBSG3132610	204,33
6000 PSI	21.5	1/2"	ZBSG6108215	68,12
6000 PSI	28.0	3/4"	ZBSG6112280	102,15
6000 PSI	34.0	1"	ZBSG6116340	112,38
6000 PSI	42.8	1"1/4	ZBSG6120428	130,80
6000 PSI	48.6	1"1/2	ZBSG6124486	187,29
6000 PSI	61.0	2"	ZBSG6132610	224,74

Contrabrida cono soldable tubo métrico

Counter-flange welding adaptor for metric tube

Contre-bride collet à souder tube métrique

Adattatore a saldare per tubo Metrico senza o'ring

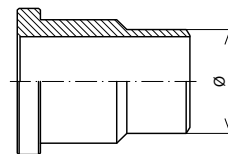

SERIE	Ø OUTER Ø EXT.	SIZE TAMAÑO	Part nº Referencia	€
3000 PSI	16	1/2"	ZBSM3008016	68,12
3000 PSI	25	3/4"	ZBSM3012025	81,74
3000 PSI	30	1"	ZBSM3016030	102,15
3000 PSI	38	1"1/4	ZBSM3020038	122,60
3000 PSI	45	1"1/2	ZBSM3024045	170,27
3000 PSI	60	2"	ZBSM3032060	204,33
3000 PSI	70	2"1/2	ZBSM3040070	272,42
3000 PSI	80	3"	ZBSM3048080	476,75
3000 PSI	100	3"1/2	ZBSM3056100	681,08
3000 PSI	114.3	4"	ZBSM3064114	817,29
6000 PSI	16	1/2"	ZBSM6008016	68,12
6000 PSI	25	3/4"	ZBSM6012025	102,15
6000 PSI	30	1"	ZBSM6016030	112,38
6000 PSI	38	1"1/4	ZBSM6020038	130,80
6000 PSI	45	1"1/2	ZBSM6024045	187,29
6000 PSI	60	2"	ZBSM6032060	224,74

Contrabrida cono soldable tubo gas

Counter-flange welding adaptor for gas tube

Contre-bride collet à souder tube gaz

Adattatore a saldare per tubo gas senza o'ring

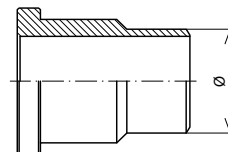

SERIE	Ø INNER Ø INT.	SIZE TAMAÑO	Part nº Referencia	€
3000 PSI	21.5	1/2"	ZBSG3008215	68,12
3000 PSI	28.0	3/4"	ZBSG3012280	81,74
3000 PSI	34.0	1"	ZBSG3016340	102,15
3000 PSI	42.8	1"1/4	ZBSG3020428	122,60
3000 PSI	48.6	1"1/2	ZBSG3024486	170,27
3000 PSI	61.0	2"	ZBSG3032610	204,33
6000 PSI	21.5	1/2"	ZBSG6008215	68,12
6000 PSI	28.0	3/4"	ZBSG6012280	102,15
6000 PSI	34.0	1"	ZBSG6016340	112,38
6000 PSI	42.8	1"1/4	ZBSG6020428	130,80
6000 PSI	48.6	1"1/2	ZBSG6024486	187,29
6000 PSI	61.0	2"	ZBSG6032610	224,74

Bridas SAE

SAE Flanges
Brides SAE
Flange SAE

Tornillos para bridas SAE

Screws for SAE flanges



Vis pour brides SAE

Vite per flangia SAE

THREAD ROSCA	SIZE TAMAÑO	Part n° Referencia	€
M8X30	3000-6000 PSI 1/2"	ZTB8X30	0,80
M10X35	3000 PSI 3/4"-1"	ZTB10X35	1,51
M10X40	3000 PSI 1" 1/4 - 6000 PSI 3/4"	ZTB10X40	1,65
M12X45	3000 PSI 1"1/2-2"-2"1/2-6000 PSI 1"	ZTB12X45	3,21
M14X45	6000 PSI 1"1/4	ZTB14X45	5,18
M16X50	3000 PSI 3"-3"1/2"-4"- 6000 PSI 1" 1/2	ZTB16X50	7,10
M20X70	6000 PSI 2"	ZTB20X70	16,25

Juntas para bridas SAE 3000/6000 PSI

Seals for 3000/6000 PSI flange



Joints pour bride série 3000/6000

Guarnizioni per flangia SAE 3000/6000 PSI

Ø OUTER Ø EXT.	Ø INNER Ø INT.	SIZE TAMAÑO	Part n° Referencia	€
25.40	17.02	1/2"	JBR08	*
31.72	23.36	3/4"	JBR12	*
39.62	31.24	1"	JBR16	*
44.45	36.07	1"1/4	JBR20	*
53.98	45.34	1"1/2	JBR24	*
63.50	54.86	2"	JBR32	*

*Ver precios en Conducciones Hidráulicas y Neumáticas / *See prices in Hydraulic and Pneumatic Connectors' Catalogue / *Voir prix dans le Catalogue Connectique Hydraulique et Pneumatique / *Vedere prezzi nel listino Conduzioni Idrauliche e Pneumatiche

Juntas tóricas para bridas SAE 3000/6000 PSI

O' rings for 3000/6000 PSI flange



O' rings pour bride série 3000/6000 PSI

O' rings per flangia SAE 3000/6000 PSI

Ø INNER Ø INT.	SIZE TAMAÑO	Part n° Referencia	€
18.64	1/2"	18.64X3.53	*
24.99	3/4"	24.99X3.53	*
32.92	1"	32.92X3.53	*
37.70	1"1/4	37.70X3.53	*
47.22	1"1/2	47.22X3.53	*
56.74	2"	56.74X3.53	*

*Ver precios en Conducciones Hidráulicas y Neumáticas / *See prices in Hydraulic and Pneumatic Connectors' Catalogue / *Voir prix dans le Catalogue Connectique Hydraulique et Pneumatique / *Vedere prezzi nel listino Conduzioni Idrauliche e Pneumatiche

Abrazaderas TrΔle

TrΔle Clamps

Colliers TrΔle

Collari fissatubo TrΔle

Crimping fittings for hoses

Pipe fittings

Pipe fittings II

Adaptors

Welding fittings

Industrial fittings

Accessories

Control components

Flow measuring

TrΔle LOK

Abrazadera ligera simple completa

Light serie simple clamp

Collier de fixation simple complet, série légère

Collari fissatubo singoli completo



DN	GROUP GRUPO	Part nº Referencia	€
6	G-1	ZA40AZ06	11,01
8	G-1	ZA40AZ08	11,01
10	G-1	ZA40AZ10	11,01
12	G-1	ZA40AZ12	11,01
14	G-2	ZA40AZ14	11,62
15	G-2	ZA40AZ15	11,62
16	G-2	ZA40AZ16	11,62
18	G-2	ZA40AZ18	11,62
20	G-3	ZA40AZ20	12,42
22	G-3	ZA40AZ22	12,42
23	G-3	ZA40AZ23	12,42
25	G-3	ZA40AZ25	12,42
28	G-4	ZA40AZ28	13,71
30	G-4	ZA40AZ30	13,71
38	G-5	ZA40AZ38	15,83
40	G-5	ZA40AZ40	15,83
42	G-5	ZA40AZ42	15,83

Abrazadera ligera reforzada completa

Light serie reinforced clamp

Collier de fixation simple série légère renforcé complet

Collare fissatubo rinforzato completo



DN	GROUP GRUPO	Part nº Referencia	€
6	G-1	ZA41AZ06	13,99
8	G-1	ZA41AZ08	13,99
10	G-1	ZA41AZ10	13,99
12	G-1	ZA41AZ12	13,99
14	G-2	ZA41AZ14	14,94
15	G-2	ZA41AZ15	14,94
16	G-2	ZA41AZ16	14,94
18	G-2	ZA41AZ18	14,94
20	G-3	ZA41AZ20	16,20
22	G-3	ZA41AZ22	16,20
23	G-3	ZA41AZ23	16,20
25	G-3	ZA41AZ25	16,20
28	G-4	ZA41AZ28	17,44
30	G-4	ZA41AZ30	17,44
38	G-5	ZA41AZ38	20,61
40	G-5	ZA41AZ40	20,61
42	G-5	ZA41AZ42	20,61

Abrazadera ligera simple completa, plásticos perfil liso

Light serie simple clamp, plastic smooth profile

Collier de fixation simple série légère, complet, plastic profil lisse

Collari fissatubo singoli completo, profilo liscio di plastica



DN	GROUP GRUPO	Part nº Referencia	€
8	G-1	ZA40AZ08PL	11,01
10	G-1	ZA40AZ10PL	11,01
12	G-1	ZA40AZ12PL	11,01
1/4"	G-2	ZA40AZ13.2PL	11,62
15	G-2	ZA40AZ15PL	11,62
3/8"	G-2	ZA40AZ16.7PL	11,62
18	G-2	ZA40AZ18PL	11,62
20	G-3	ZA40AZ20PL	12,42
1/2"	G-3	ZA40AZ21.3PL	12,42
22	G-3	ZA40AZ22PL	12,42
25	G-3	ZA40AZ25PL	12,42
3/4"	G-4	ZA40AZ26.7PL	13,71
28	G-4	ZA40AZ28PL	13,71
30	G-4	ZA40AZ30PL	13,71
1"	G-5	ZA40AZ33.3PL	15,83
35	G-5	ZA40AZ35PL	15,83
38	G-5	ZA40AZ38PL	15,83
42	G-5	ZA40AZ42PL	15,83

Abrazadera ligera reforzada completa, plásticos perfil liso

Light serie reinforced clamp, plastic smooth profile

Collier de fixation simple série légère renforcé, complet, plastic profil lisse

Collare fissatubo rinforzato completo, profilo liscio di plastica



DN	GROUP GRUPO	Part nº Referencia	€
8	G-1	ZA41AZ08PL	13,99
10	G-1	ZA41AZ10PL	13,99
12	G-1	ZA41AZ12PL	13,99
1/4"	G-2	ZA41AZ13.2PL	14,94
15	G-2	ZA41AZ15PL	14,94
3/8"	G-2	ZA41AZ16.7PL	14,94
18	G-2	ZA41AZ18PL	14,94
20	G-3	ZA41AZ20PL	16,20
1/2"	G-3	ZA41AZ21.3PL	16,20
22	G-3	ZA41AZ22PL	16,20
25	G-3	ZA41AZ25PL	16,20
3/4"	G-4	ZA41AZ26.7PL	17,44
28	G-4	ZA41AZ28PL	17,44
30	G-4	ZA41AZ30PL	17,44
1"	G-5	ZA41AZ33.3PL	20,61
35	G-5	ZA41AZ35PL	20,61
38	G-5	ZA41AZ38PL	20,61
42	G-5	ZA41AZ42PL	20,61

Abrazaderas TrΔle

TrΔle Clamps

Colliers TrΔle

Collari fissatubo TrΔle

Plásticos polipropileno, serie ligera

Plastics polypropylene, light serie

Plastique polypropylene, série légère

Plastica polipropilene

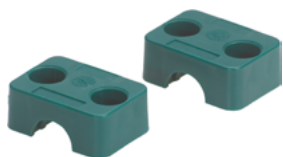

DN	GROUP GRUPO	Part n° Referencia	€
6	1	A106C	*
8	1	A108C	*
10	1	A110C	*
12	1	A112C	*
1/4"	2	A213.2C	*
14	2	A214C	*
15	2	A215C	*
3/8"	2	A216.7C	*
16	2	A216C	*
18	2	A218C	*
19	3	A319C	*
20	3	A320C	*
1/2"	3	A321.3C	*
22	3	A322C	*
23	3	A323C	*
25	3	A325C	*
3/4"	4	A426.7C	*
28	4	A428C	*
30	4	A430C	*
32	5	A532C	*
1"	5	A533.7C	*
35	5	A535C	*
38	5	A538C	*
40	5	A540C	*
42	5	A542C	*
44.5	6	A644.5C	*
1 1/2"	6	A648.3C	*
50.8	6	A650.8C	*

*Precio por pareja. Ver precios en Tarifa Conducciones Hidráulicas y Neumáticas / *Price per couple. See prices in Hydraulic and Pneumatic Connectors' Catalogue / *Prix par paire. Voir les prix dans le Catalogue Connectique Hydraulique et Pneumatique / *Prezzo per coppia. Vedere prezzi nel listino Conduzioni Idrauliche e Pneumatiche

Chapas inferiores, serie ligera

Lower plate, light serie

Plaque inférieure, série légère

Piastre inferiori



GROUP GRUPO	Part n° Referencia	€
1	ZAPIN1	8,68
2	ZAPIN2	9,02
3	ZAPIN3	9,41
4	ZAPIN4	9,80
5	ZAPIN5	10,47
6	ZAPIN6	13,05

Chapas superiores, serie ligera

Upper plate, light serie

Plaque supérieure, série légère

Piastre superiore



GROUP GRUPO	Part n° Referencia	€
1	ZAPS1	2,71
2	ZAPS2	3,00
3	ZAPS3	3,39
4	ZAPS4	3,87
5	ZAPS5	4,50
6	ZAPS6	5,18

Tornillos Allen, serie ligera

Allen screw, light serie

Vis Allen, série légère

Vite Allen



THREAD ROSCA	GROUP GRUPO	Part n° Referencia	€
M6	1	ZAVTC1	0,97
M6	2	ZAVTC2	0,45
M6	3	ZAVTC3	1,22
M6	4	ZAVTC4	1,59
M6	5	ZAVTC5	2,05
M6	6	ZAVTC6	2,54

Precio por unidad / Price per unit / Prix à l'unité / Prezzo unitario

Tornillos Hexagonales, serie ligera

Hexagonal screw, light serie

Vis Hexagonal, série légère

Vite esagonale



THREAD ROSCA	GROUP GRUPO	Part n° Referencia	€
M6	1	ZAVTE1	0,97
M6	2	ZAVTE2	1,10
M6	3	ZAVTE3	1,35
M6	4	ZAVTE4	1,43
M6	5	ZAVTE5	2,11
M6	6	ZAVTE6	3,05

Precio por unidad / Price per unit / Prix à l'unité / Prezzo unitario

Chapas para apilar abrazaderas, serie ligera

Plates to pile up clamps, light serie

Plaques pour empiler colliers, série légère

Piastre componibili. Serie leggera

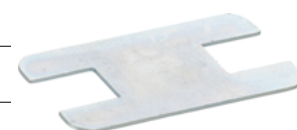

GROUP GRUPO	Part n° Referencia	€
1	ZAPA1	1,25
2	ZAPA2	1,50
4	ZAPA4	1,94
3	ZAPA3	1,72
5	ZAPA5	2,19
6	ZAPA6	3,07

Abrazaderas TrΔle

TrΔle Clamps
Colliers TrΔle
Collari fissatubo TrΔle

Abrazaderas dobles completas

Double clamp - parallel

Colliers de fixation doubles complets

Collare fissatubo doppio completo

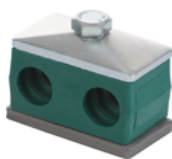

DN	GROUP GRUPO	Part nº Referencia	€
6	G.1	ZAZCFS06	10,23
8	G.1	ZAZCFS08	10,23
10	G.1	ZAZCFS10	10,23
12	G.1	ZAZCFS12	10,23
14	G.2	ZAZCFS14	20,21
15	G.2	ZAZCFS15	20,21
16	G.2	ZAZCFS16	20,21
18	G.2	ZAZCFS18	20,21
20	G.3	ZAZCFS20	21,77
22	G.3	ZAZCFS22	21,77
25	G.3	ZAZCFS25	21,77
28	G.4	ZAZCFS28	26,51
30	G.4	ZAZCFS30	26,51
35	G.5	ZAZCFS35	31,47
38	G.5	ZAZCFS38	31,47
40	G.5	ZAZCFS40	31,47
42	G.5	ZAZCFS42	31,47

Chapas inferiores

Double Lower plate

Plaques inférieures à souder double

Piastre inferiori

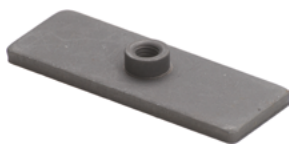

THREAD ROSCA	GROUP GRUPO	Part nº Referencia	€
M6	1	ZADPIN1	5,66
M8	2	ZADPIN2	12,95
M8	3	ZADPIN3	13,78
M8	4	ZADPIN4	14,73
M8	5	ZADPIN5	16,28

Chapas superiores

Double Upper plate

Plaques supérieures de protection double

Piastre superiori



GROUP GRUPO	Part nº Referencia	€
1	ZADPS1	2,92
2	ZADPS2	4,50
3	ZADPS3	4,99
4	ZADPS4	8,50
5	ZADPS5	10,42

Plásticos polipropileno dobles

Double plastics polypropylene

Plastiques polypropylene doubles

Plastica polipropilene

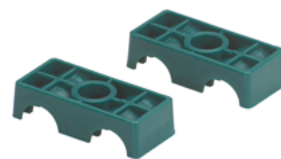

DN	GROUP GRUPO	Part nº Referencia	€
6	1	AD106C	*
8	1	AD108C	*
10	1	AD110C	*
12	1	AD112C	*
1/4"	2	AD213.2C	*
14	2	AD214C	*
15	2	AD215C	*
3/8"	2	AD216.7C	*
16	2	AD216C	*
18	2	AD218C	*
19	3	AD319C	*
20	3	AD320C	*
1/2"	3	AD321.3C	*
22	3	AD322C	*
25	3	AD325C	*
3/4"	4	AD426.7C	*
28	4	AD428C	*
30	4	AD430C	*
32	5	AD532C	*
1"	5	AD533.3C	*
35	5	AD535C	*
38	5	AD538C	*
40	5	AD540C	*
42	5	AD542C	*

*Precio por pareja. Ver precios en Tarifa Conducciones Hidráulicas y Neumáticas / *Price per couple. See prices in Hydraulic and Pneumatic Connectors' Catalogue / *Prix par paire. Voir les prix dans le Catalogue Connectique Hydraulique et Pneumatique / *Prezzo per coppia. Vedere prezzi nel listino Conduzione Idrauliche e Pneumatiche

Tornillos cabeza hexagonal

Hexagonal screw

Vis hexagonale

Vite esagonale



THREAD ROSCA	GROUP GRUPO	Part nº Referencia	€
M6	1	ZADVTE1	1,22
M8	2	ZADVTE2	2,43
M8	3	ZADVTE3	2,51
M8	4	ZADVTE4	2,59
M8	5	ZADVTE5	3,46

Precio por unidad / Price per unit / Prix à l'unité / Prezzo unitario

Abrazaderas TrΔle

TrΔle Clamps

Colliers TrΔle

Collari fissatubo TrΔle

Abrazaderas Inox Serie pesada completas

Heavy Series Stainless Steel Clamps

Pinces en acier inoxydable série lourde

Morsetti in acciaio inossidabile serie pesante

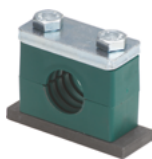

DN	GROUP GRUPO	Part n° Referencia	€
6	1	ZAZCPS06	41,40
8	1	ZAZCPS08	41,40
10	1	ZAZCPS10	41,40
12	1	ZAZCPS12	41,40
1/4"	1	ZAZCPS13.2	41,40
14	1	ZAZCPS14	41,40
15	1	ZAZCPS15	41,40
16	1	ZAZCPS16	41,40
3/8	1	ZAZCPS17.2	41,40
18	1	ZAZCPS18	41,40
20	2	ZAZCPS20	50,18
1/2"	2	ZAZCPS21.3	50,18
22	2	ZAZCPS22	50,18
25	2	ZAZCPS25	50,18
3/4"	2	ZAZCPS26.7	50,18
28	2	ZAZCPS28	50,18
30	2	ZAZCPS30	50,18
32	3	ZAZCPS32	62,72
1"	3	ZAZCPS33.3	62,72
35	3	ZAZCPS35	62,72
38	3	ZAZCPS38	62,72
40	3	ZAZCPS40	62,72
42 - 1" 1/4	3	ZAZCPS42	62,72
45	4	ZAZCPS45	125,44
48-1" 1/2	4	ZAZCPS48	125,44
50	4	ZAZCPS50	125,44
55	4	ZAZCPS55	125,44
2"	4	ZAZCPS60.3	125,44
65	4	ZAZCPS65	125,44
70	4	ZAZCPS70	125,44

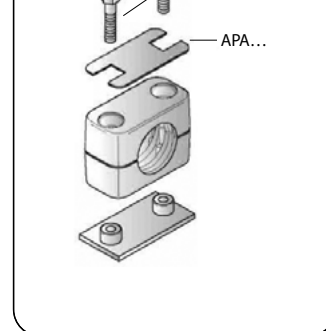
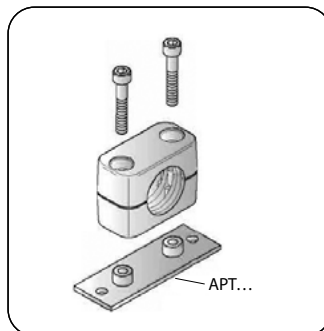
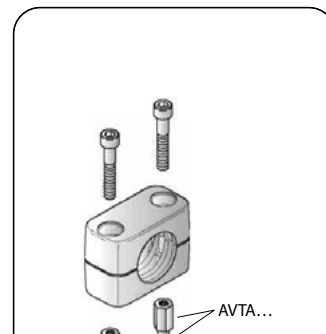
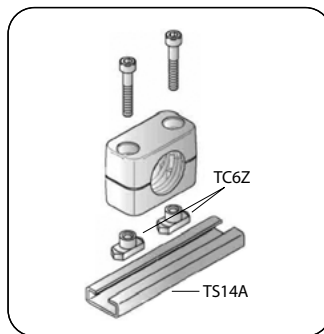
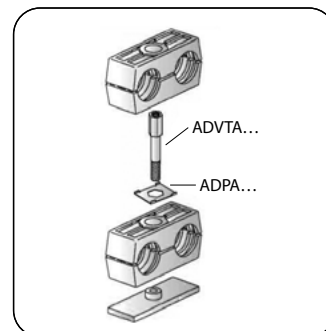
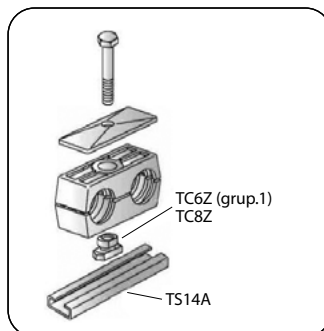
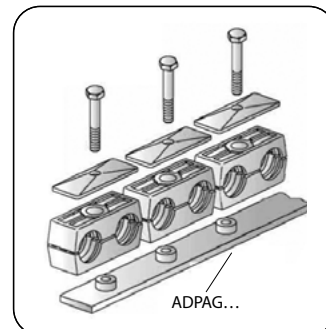
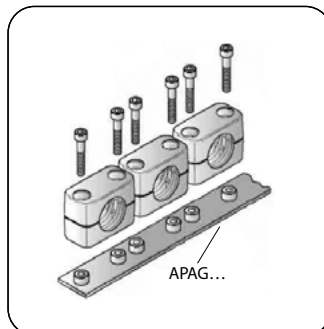

Abrazaderas TrΔle

TrΔle Clamps
Colliers TrΔle
Collari fissatubo TrΔle

Plásticos polipropileno, serie pesada

Plastics polypropylene, heavy serie

Plastique polypropylene, série lourde

Plastica polipropilene, serie pesante

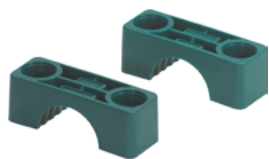

DN	GROUP GRUPO	Part n° Referencia	€
6	1	AMPP106C	*
8	1	AMPP108C	*
10	1	AMPP110C	*
12	1	AMPP112C	*
1/4"	1	AMPP113.2C	*
14	1	AMPP114C	*
15	1	AMPP115C	*
16	1	AMPP116C	*
3/8"	1	AMPP117.2C	*
18	1	AMPP118C	*
20	2	AMPP220C	*
1/2"	2	AMPP221.3C	*
22	2	AMPP222C	*
25	2	AMPP225C	*
3/4"	2	AMPP226.7C	*
28	2	AMPP228C	*
30	2	AMPP230C	*
30	3	AMPP330C	*
32	3	AMPP332C	*
1"	3	AMPP333.3C	*
35	3	AMPP335C	*
38	3	AMPP338C	*
40	3	AMPP340C	*
42	3	AMPP342C	*
38	4	AMPP438C	*
42- 1" 1/4	4	AMPP442C	*
45	4	AMPP445C	*
48- 1" 1/2	4	AMPP448C	*
50	4	AMPP450C	*
55	4	AMPP455C	*
2"	4	AMPP460.3C	*
65	4	AMPP465C	*
70	4	AMPP470C	*

*Precio por pareja. Ver precios en Tarifa Conducciones Hidráulicas y Neumáticas / *Price per couple. See prices in Hydraulic and Pneumatic Connectors' Catalogue / *Prix par paire. Voir les prix dans le Catalogue Connectique Hydraulique et Pneumatique / *Prezzo per coppia. Vedere prezzi nel listino Conduzioni Idrauliche e Pneumatiche

Chapas inferiores, serie pesada

Lower plate, heavy serie

Plaque inférieure, série lourde

Piastre inferiori, serie pesante



THREAD ROSCA	GROUP GRUPO	Part n° Referencia	€
M10	1	ZAPINP1	32,31
M10	2	ZAPINP2	42,59
M10	3	ZAPINP3	52,85
M12	4	ZAPINP4	80,54

Chapas superiores, serie pesada

Upper plate, heavy serie

Plaque supérieure, série lourde

Piastre superiori, serie pesante



GROUP GRUPO	Part n° Referencia	€
1	ZAPSP1	14,78
2	ZAPSP2	16,75
3	ZAPSP3	21,92
4	ZAPSP4	50,14

Tornillos, serie pesada

Screw, heavy serie

Vis, série lourde

Vite, serie pesante



THREAD ROSCA	GROUP GRUPO	Part n° Referencia	€
M10	1	ZAVTEP1	3,83
M10	2	ZAVTEP2	4,55
M10	3	ZAVTEP3	5,20
M12	4	ZAVTEP4	10,98

Precio por unidad / Price per unit / Prix à l'unité / Prezzo unitario

Accesorios para carril

Rail accessories

Accessoires pour rail

Accessori per lane



THREAD ROSCA	DESCRIPCIÓN	Part n° Referencia	€
M6	Rail nut	TC6I	10,41
M8	Rail nut	TC8I	14,52
--	Mounting rail	TS11I	60,62
--	Mounting rail	TS14I	67,03

Adaptadores

Adaptors

Adapteurs

Adattatori

Adaptadores BSP

BSP Adaptors
Adapteurs BSP
Adattatori BSP

151

Adaptadores NPT

NPT Adaptors
Adapteurs NPT
Adattatori NPT

159

Adaptadores O'Ring Boss

O'Ring Boss Adaptors
Adapteurs O'Ring Boss
Adattatori O'Ring Boss

162

Adaptadores ORFS

ORFS Adaptors
Adapteurs ORFS
Adattatori ORFS

164

4

Adaptadores BSP

BSP Adaptors
Adaptateurs BSP
Adattatori BSP

■ Uniones rectas macho / Straight male adaptors / Unions mâle / Adattatori diritti maschio | 151

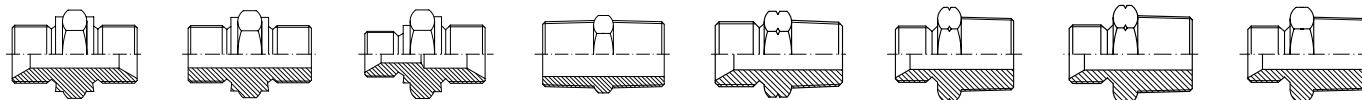

Z1010

Z1011

Z1020

Z1016

Z1014

Z1024

Z1012

Z1022

■ Uniones rectas macho-hembra / Adaptors male-female / Unions mâle-femelle / Adattatori diritti maschio-femmina | 153

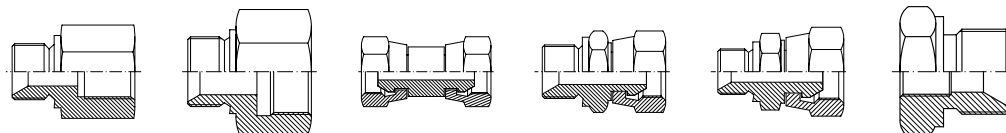

Z1060

Z1060

Z1172

Z1170

Z1173

Z1150

■ Tapones / Plugs / Bouchons / Tappi | 154

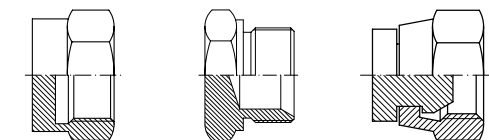

Z1072

Z1070

Z1075

■ Uniones hembra y pasatabiques / Female adaptors and bulkheads / Unions femelle et passe-cloison / Raccordi femmina e passaparete | 155

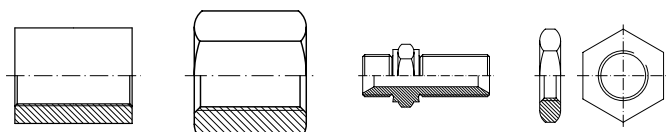

Z1310

Z1031

Z1160

Z1161

■ Orientables / Banjos / Adaptateurs orientables / Bulloni forati | 155

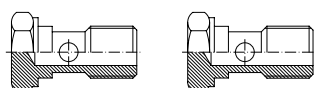

Z1090

Z1092

■ Juntas metal FKM / Joints / Bague BS / Rondelle Bonded | 156

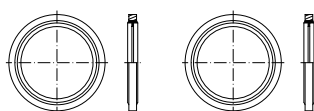

ZVT210

ZVT320

■ Codos accesorias / Elbows / Adaptateurs coude accessoiriel / Adattatori a 90° e 45° tubolari | 156

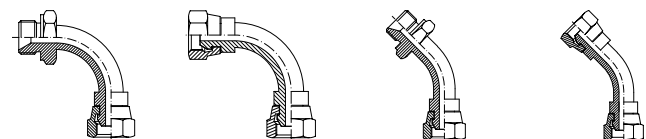

Z1194

ZA1196

Z1195

ZA1195

■ Codos en forja / Forging elbows / Adaptateurs coude en forge / Adattatori a 90° e 45° forgiati | 157

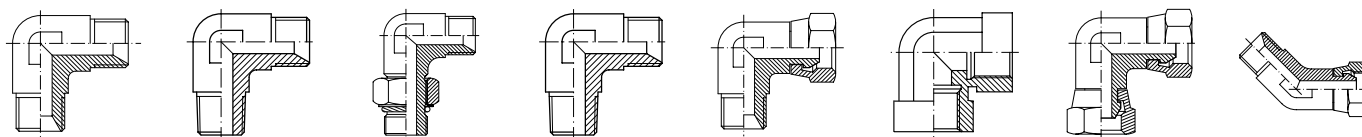

Z1190

Z1192

Z1197

Z1191

Z1193

Z1196

Z1198

Z1183

Adaptadores BSP

BSP Adaptors
 Adapteurs BSP
 Adattatori BSP

■ Tes en forja / Forging Tees / Adapteurs Té en forge / Adattatori a T forgiati

158

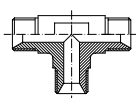

Z1220

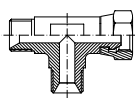

Z1222

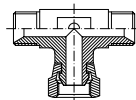

Z1224

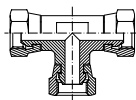

Z1228

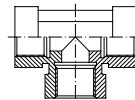

Z1226

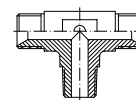

Z1221

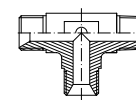

Z1223

Adaptadores NPT

NPT Adaptors
Adaptateurs NPT
Adattatori NPT

- Uniones rectas macho-macho / Straight male adaptors / Unions mâle / Adattatori diritti maschio - maschio | 159

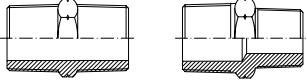

ZN1015

ZN1015

- Uniones rectas macho-hembra / Adaptors male-female / Unions mâle-femelle / Adattatori diritti maschio - femmina | 159

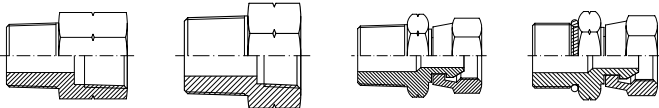

ZN1060

ZN1150

ZN1170

ZN1174

- Tapones / Plugs / Bouchons / Tappi | 160

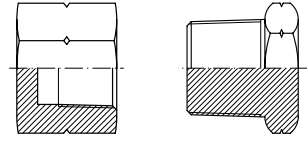

ZN1072

ZN1070

- Uniones hembra y pasatabiques / Female adaptors and bulkheads / Unions femelle et passe cloisson / Adattatori femmina e passaparete | 160

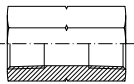

ZN1031

- Codos en forja / Forging elbows / Adapteurs coude en forge / Adattatori a 90° e 45° forgiati | 161

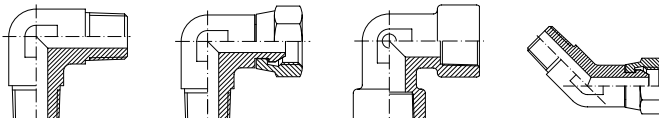

ZN1190

ZN1193

ZN1196

ZN1393

- Tes en forja / Forging tees / Adapteurs Té en forge / Adattatori a T forgiati | 161

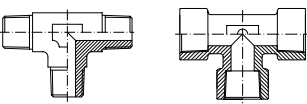

ZN1220

ZN1226

Adaptadores O'Ring Boss

O'Ring Boss Adaptors
 Adapteurs O'Ring Boss
 Adattatori O'Ring Boss

- Uniones rectas macho / Straight male adaptors / Unions mâle / Unione diritta maschio | 162

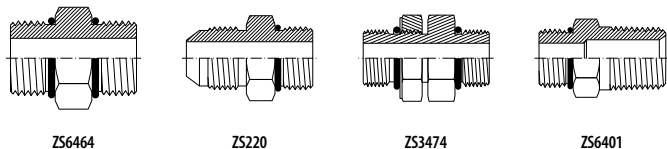

- Uniones rectas macho-hembra / Adaptors male-female / Unions mâle-femelle / Unione diritta maschio-femmina | 162

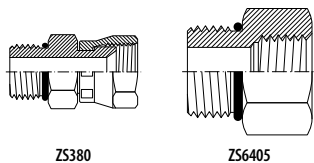

- Tapones / Plugs / Bouchons / Tappi | 163

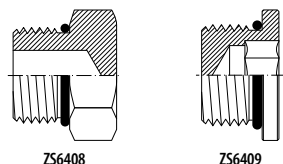

- Codos en forja / Forging elbows and tees / Adapteurs coude et té en forge / Curve e T forgiati | 163

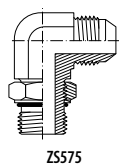

- Tes en forja / Forging Tees / Adapteurs Té en forge / Adattatori a T forgiati | 163

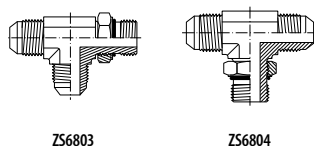

Adaptadores ORFS

ORFS Adaptors
Adaptateurs ORFS
Adattatori ORFS

- Conos y tapones ORFS / ORFS Nuts, nipples and plugs / Écrous, collets et bouchons ORFS / Dado, Ogive e Tappi | 164

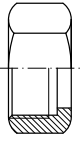

ZOR102

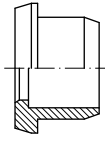

ZOR1273

- Tapones / Plugs / Bouchons / Tappi | 164

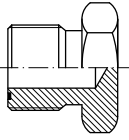

ZOR104

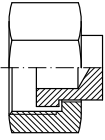

ZOR105

- Uniones rectas ORFS / ORFS Straight unions / Unions droites ORFS / Adattatori diritti ORFS | 164

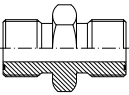

ZOR200

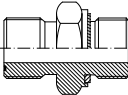

ZOR202

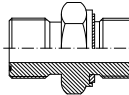

ZOR1017

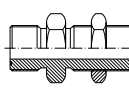

ZOR106

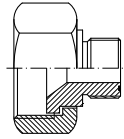

ZOR301

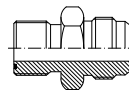

ZOR204

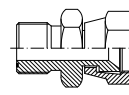

ZOR302

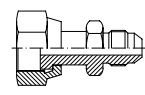

ZOR305

- Codos en forja ORFS / ORFS Elbows / Coudes ORFS / Adattatori a 90° ORFS | 166

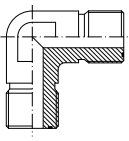

ZOR405

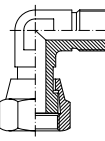

ZOR600

- Tes en forja ORFS / ORFS Tees / Tés ORFS / Adattatori a T ORFS | 166

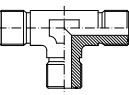

ZOR700

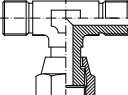

ZOR701

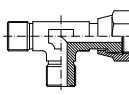

ZOR702



JVORFS

Adaptadores BSP

BSP Adaptors
Adaptateurs BSP
Adattatori BSP

Crimping fittings for hoses

Pipe fittings

Pipe fittings II

Adaptors

Welding fittings

Industrial fittings

Accessories

Control components

Flow measuring

Tri/Le LOK

Adaptador macho - macho BSP cono 60°

Adaptor male BSP 60° - male BSP 60°

Adaptateur mâle BSP - mâle BSP cone 60°

Niples di giunzione BSP 60°

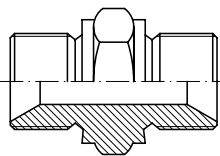

THREAD ROSCA		Part n° Referencia	€
1/8" BSP	1/8" BSP	Z101002	8,06
1/4" BSP	1/4" BSP	Z101004	7,43
1/4" BSP	1/4" BSP	Z101004H19	10,36
3/8" BSP	3/8" BSP	Z101006	8,73
1/2" BSP	1/2" BSP	Z101008	11,91
5/8" BSP	5/8" BSP	Z101010	26,41
3/4" BSP	3/4" BSP	Z101012	17,85
1" BSP	1" BSP	Z101016	34,60
1"1/4 BSP	1"1/4 BSP	Z101020	53,64
1"1/2 BSP	1"1/2 BSP	Z101024	60,57
2" BSP	2" BSP	Z101032	101,50
2" BSP	2" BSP	Z101032H70	139,94

Adaptador macho - macho BSP asiento plano

Adaptor male BSP - male BSP flat seat

Adaptateur mâle BSP - mâle BSP fond plat

Niples di giunzione BSP sede piana

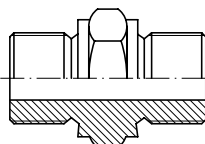

THREAD ROSCA		Part n° Referencia	€
1/4 BSP	1/4 BSP	Z101104	11,61
3/8 BSP	3/8 BSP	Z101106	13,53
1/2 BSP	1/2 BSP	Z101108	14,95
3/4 BSP	3/4 BSP	Z101112	20,38
1" BSP	1" BSP	Z101116	37,37
1"1/4 BSP	1"1/4 BSP	Z101120	57,24
1"1/2 BSP	1"1/2 BSP	Z101124	67,73
2" BSP	2" BSP	Z101132	112,94

Reductor macho - macho BSP cono 60°

Reducer male adaptor BSP 60° - male BSP 60°

Réducteur mâle BSP - mâle BSP cone 60°

Niples di riduzione BSP 60°

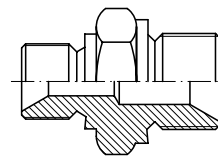

THREAD ROSCA		Part n° Referencia	€
1/8" BSP	1/4" BSP	Z10200204	8,18
1/8" BSP	1/4" BSP	Z10200204H19	10,31
1/8" BSP	3/8" BSP	Z10200206	15,05
1/4" BSP	3/8" BSP	Z10200406	9,45
1/4" BSP	1/2" BSP	Z10200408	14,09
1/4" BSP	3/4" BSP	Z10200412	20,29
3/8" BSP	1/2" BSP	Z10200608	13,49
3/8" BSP	3/4" BSP	Z10200612	23,90
1/2" BSP	3/4" BSP	Z10200812	19,96
1/2" BSP	1" BSP	Z10200816	32,91
5/8" BSP	1/2" BSP	Z10201008	32,02
5/8" BSP	3/4" BSP	Z10201012	36,72
3/4" BSP	1" BSP	Z10201216	38,14
3/4" BSP	1"1/4 BSP	Z10201220	52,49
1" BSP	1"1/4 BSP	Z10201620	50,94
1" BSP	1"1/2 BSP	Z10201624	75,48
1"1/4 BSP	1"1/2 BSP	Z10202024	72,56
1"1/4 BSP	2" BSP	Z10202032	115,33
1"1/2 BSP	2" BSP	Z10202432	114,20
1"1/2 BSP	2" BSP	Z10202432H70	144,88

Adaptador macho - macho BSPT

Adaptor male BSPT - male BSPT

Adaptor mâle gaz conique BSPT - mâle gaz conique BSPT

Niples di congiunzione BSPT

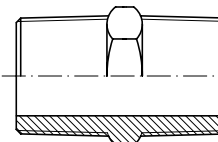

THREAD ROSCA		Part n° Referencia	€
1/4" BSPT	1/4" BSPT	Z10160404	9,61
3/8" BSPT	3/8" BSPT	Z10160606	12,40
1/2" BSPT	1/2" BSPT	Z10160808	13,15
3/4" BSPT	3/4" BSPT	Z10161212	20,96
1" BSPT	1" BSPT	Z10161616	38,91
1" 1/4 BSPT	1" 1/4 BSPT	Z10162020	68,01
1" 1/2 BSPT	1" 1/2 BSPT	Z10162424	83,32
2" BSPT	2" BSPT	Z10163232	129,15

Adaptador macho BSP 60° - macho NPT

Adaptor male BSP 60° - male NPT

Adaptateur mâle BSP cone 60° - mâle BRIGGS (NPT)

Niples di congiunzione BSP 60° - NPT

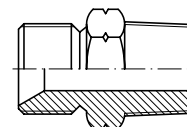

THREAD ROSCA		Part n° Referencia	€
1/8" BSP	1/8" NPT	Z101402	9,82
1/4" BSP	1/4" NPT	Z101404	8,58
3/8" BSP	3/8" NPT	Z101406	11,09
1/2" BSP	1/2" NPT	Z101408	12,76
3/4" BSP	3/4" NPT	Z101412	17,60
1" BSP	1" NPT	Z101416	31,40
1"1/4 BSP	1"1/4 NPT	Z101420	49,16
1"1/2 BSP	1"1/2 NPT	Z101424	73,46
2" BSP	2" NPT	Z101432	103,25

Adaptadores BSP

BSP Adaptors
Adaptateurs BSP
Adattatori BSP

Reductor macho BSP 60° - macho NPT

Reducer adaptor male BSP 60° - male NPT

Réducteur mâle BSP cone 60° - mâle BRIGGS NPT

Niples di riduzione BSP 60° - NPT

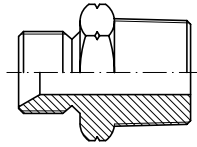

THREAD ROSCA		Part n° Referencia	€
1/8" BSP	1/4" NPT	Z10240204	15,23
1/4" BSP	1/8" NPT	Z10240402	16,37
1/4" BSP	3/8" NPT	Z10240406	13,98
1/4" BSP	1/2" NPT	Z10240408	18,10
3/8" BSP	1/4" NPT	Z10240604	16,10
3/8" BSP	1/2" NPT	Z10240608	17,60
3/8" BSP	3/4" NPT	Z10240612	22,10
1/2" BSP	3/8" NPT	Z10240806	18,09
1/2" BSP	3/4" NPT	Z10240812	22,72
5/8" BSP	3/4" NPT	Z10241012	32,37
3/4" BSP	1/4" NPT	Z10241204	38,94
3/4" BSP	3/8" NPT	Z10241206	24,91
3/4" BSP	1/2" NPT	Z10241208	27,48
3/4" BSP	1" NPT	Z10241216	33,79
3/4" BSP	1" 1/4 NPT	Z10241220	77,05
3/4" BSP	1" 1/2 NPT	Z10241224	81,26
1" BSP	1/2" NPT	Z10241608	36,54
1" BSP	3/4" NPT	Z10241612	35,68
1" BSP	1" 1/4 NPT	Z10241620	59,91
1" 1/4 BSP	1" NPT	Z10242016	70,08
1" 1/4 BSP	1" 1/2 NPT	Z10242024	75,15
1" 1/2 BSP	1" 1/4 NPT	Z10242420	80,73
1" 1/2 BSP	2" NPT	Z10242432	108,99
2" BSP	1" 1/2 NPT	Z10243224	111,20

Adaptador macho BSP 60° - macho BSPT

Adaptor male BSP 60° - male BSPT

Adaptateur mâle BSP cone 60° - mâle gaz conique BSPT

Niples di congiunzione BSP 60° - BSPT

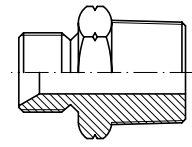

THREAD ROSCA		Part n° Referencia	€
1/8" BSP	1/8" BSPT	Z101202	9,08
1/4" BSP	1/4" BSPT	Z101204	8,09
3/8" BSP	3/8" BSPT	Z101206	10,29
1/2" BSP	1/2" BSPT	Z101208	12,69
3/4" BSP	3/4" BSPT	Z101212	17,28
1" BSP	1" BSPT	Z101216	30,17
1" 1/4 BSP	1" 1/4 BSPT	Z101220	53,63
1" 1/2 BSP	1" 1/2 BSPT	Z101224	71,75
2" BSP	2" BSPT	Z101232	103,47

Reductor macho BSP 60° - macho BSPT

Reducer adaptor male BSP 60° - male BSPT

Réducteur mâle BSP cone 60° - mâle gaz conique BSPT

Niples di riduzione BSP 60° - BSPT

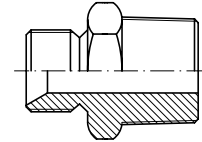

THREAD ROSCA		Part n° Referencia	€
1/8" BSP	1/4" BSPT	Z10220204	20,36
1/4" BSP	1/8" BSPT	Z10220402	14,03
1/4" BSP	3/8" BSPT	Z10220406	15,53
1/4" BSP	1/2" BSPT	Z10220408	18,44
1/4" BSP	3/4" BSPT	Z10220412	33,60
3/8" BSP	1/2" BSPT	Z10220608	13,41
3/8" BSP	3/4" BSPT	Z10220612	29,52
1/2" BSP	1/4" BSPT	Z10220804	22,56
1/2" BSP	3/8" BSPT	Z10220806	17,98
1/2" BSP	3/4" BSPT	Z10220812	22,79
1/2" BSP	1" BSPT	Z10220816	37,98
5/8" BSP	3/4" BSPT	Z10221012	22,67
3/4" BSP	1/4" BSPT	Z10221204	29,16
3/4" BSP	3/8" BSPT	Z10221206	20,74
3/4" BSP	1/2" BSPT	Z10221208	20,85
3/4" BSP	1" BSPT	Z10221216	29,33
1" BSP	3/4" BSPT	Z10221612	32,43
1" BSP	1" 1/4 BSPT	Z10221620	62,41
1" 1/4 BSP	1" BSPT	Z10222016	70,97
1" 1/4 BSP	1" 1/2 BSPT	Z10222024	75,08
1 1/2" BSP	1 1/4" BSPT	Z10222420	79,89
1" 1/2 BSP	2" BSPT	Z10222432	119,53

Adaptadores BSP

BSP Adaptors
Adaptateurs BSP
Adattatori BSP

Crimping fittings for hoses

Pipe fittings

Pipe fittings II

Adaptors

Welding fittings

Industrial fittings

Accessories

Control components

Flow measuring

Tri/Le LOK

Prolongador macho BSP 60° - hembra fija BSP

Adaptor male BSP 60° - fixed female BSP

Prolongateur mâle BSP cone 60° - femelle gaz fixe

Prolunga maschio - femmina BSP 60°

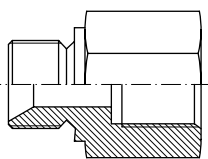

THREAD ROSCA		Part nº Referencia	€
M 1/8" BSP	F 1/8" BSP	Z106002	17,48
M 1/4" BSP	F 1/4" BSP	Z106004	13,06
M 3/8" BSP	F 3/8" BSP	Z106006	13,64
M 1/2" BSP	F 1/2" BSP	Z106008	16,90
M 3/4" BSP	F 3/4" BSP	Z106012	25,76
M 1" BSP	F 1" BSP	Z106016	36,45
M 1" 1/4 BSP	F 1" 1/4 BSP	Z106020	71,26
M 1" 1/2 BSP	F 1" 1/2 BSP	Z106024	87,67
M 2" BSP	F 2" BSP	Z106032	135,31

Reductor macho BSP 60° - hembra fija BSP

Reducer adaptor male BSP 60° - fixed female BSP

Prolongateur réducteur mâle BSP cone 60° - femelle gaz

Prolunga di riduzione maschio - femmina BSP 60°

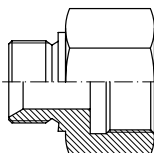

THREAD ROSCA		Part nº Referencia	€
M 1/8" BSP	F 1/4" BSP	Z10600204	15,32
M 1/8" BSP	F 3/8" BSP	Z10600206	23,75
M 1/4" BSP	F 1/8" BSP	Z10600402	16,76
M 1/4" BSP	F 3/8" BSP	Z10600406	21,71
M 1/4" BSP	F 1/2" BSP	Z10600408	23,53
M 3/8" BSP	F 1/4" BSP	Z10600604	17,54
M 3/8" BSP	F 1/2" BSP	Z10600608	22,58
M 1/2" BSP	F 1/4" BSP	Z10600804	24,89
M 1/2" BSP	F 3/8" BSP	Z10600806	20,12
M 1/2" BSP	F 3/4" BSP	Z10600812	25,38
M 3/4" BSP	F 3/8" BSP	Z10601206	22,09
M 3/4" BSP	F 1/2" BSP	Z10601208	21,63
M 3/4" BSP	F 1" BSP	Z10601216	43,85
M 1" BSP	F 3/4" BSP	Z10601612	44,42
M 1" BSP	F 1" 1/4 BSP	Z10601620	81,24
M 1" 1/4 BSP	F 1" BSP	Z10602016	73,25
M 1" 1/2 BSP	F 1" 1/4 BSP	Z10602420	85,72
M 1" 1/2 BSP	F 2" BSP	Z10602432	121,68
M 2" BSP	F 1" 1/2 BSP	Z10603224	118,59

Adaptador hembra giratoria - hembra giratoria BSP 60°

Adaptor BSP 60° swivel female - BSP 60° swivel female

Adaptateur femelle tournante BSP 60° - femelle tournante BSP 60°

Niples femmina - femmina girevole BSP 60°

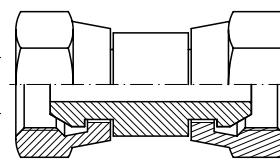

THREAD ROSCA		Part nº Referencia	€
1/4" BSP	1/4" BSP	Z117204	17,62
3/8" BSP	3/8" BSP	Z117206	21,50
1/2" BSP	1/2" BSP	Z117208	25,32
3/4" BSP	3/4" BSP	Z117212	31,58
1" BSP	1" BSP	Z117216	51,93
1" 1/4 BSP	1" 1/4 BSP	Z117220	75,79
1" 1/2 BSP	1" 1/2 BSP	Z117224	107,21
2" BSP	2" BSP	Z117232	109,68

Adaptador macho - hembra giratoria BSP cono 60°

Adaptor male BSP 60° - swivel female BSP 60°

Adaptateur mâle BSP - femelle tournante BSP cone 60°

Niples maschio - femmina girevole BSP 60°

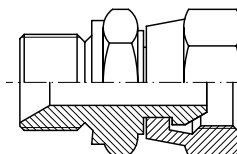

THREAD ROSCA		Part nº Referencia	€
M 1/4" BSP	F 1/4" BSP	Z117004	14,32
M 3/8" BSP	F 3/8" BSP	Z117006	17,48
M 1/2" BSP	F 1/2" BSP	Z117008	22,43
M 3/4" BSP	F 3/4" BSP	Z117012	28,63
M 1" BSP	F 1" BSP	Z117016	53,13
M 1" 1/4 BSP	F 1" 1/4 BSP	Z117020	88,61
M 1" 1/2 BSP	F 1" 1/2 BSP	Z117024	110,14
M 2" BSP	F 2" BSP	Z117032	201,63

Reductor macho - hembra giratoria BSP cono 60°

Reducer male BSP 60° - swivel female BSP 60°

Réducteur mâle BSP - femelle tournante BSP cone 60°

Niples di riduzione maschio - femmina girevole BSP 60°

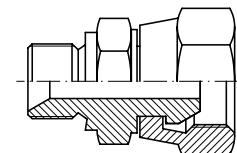

THREAD ROSCA		Part nº Referencia	€
M 1/8" BSP	F 1/4" BSP	Z11730204	14,78
M 1/4" BSP	F 1/8" BSP	Z11730402	16,04
M 1/4" BSP	F 3/8" BSP	Z11730406	20,55
M 3/8" BSP	F 1/4" BSP	Z11730604	22,12
M 3/8" BSP	F 1/2" BSP	Z11730608	24,86
M 1/2" BSP	F 3/8" BSP	Z11730806	26,71
M 1/2" BSP	F 3/4" BSP	Z11730812	34,01
M 3/4" BSP	F 1/2" BSP	Z11731208	34,25
M 3/4" BSP	F 1" BSP	Z11731216	56,46
M 1" BSP	F 3/4" BSP	Z11731612	57,27
M 1" BSP	F 1" 1/4 BSP	Z11731620	91,57
M 1" 1/4 BSP	F 1" BSP	Z11732016	107,39
M 1" 1/4 BSP	F 1" 1/2 BSP	Z11732024	119,35
M 1" 1/2 BSP	F 1" 1/4 BSP	Z11732420	121,72
M 1" 1/2 BSP	F 2" BSP	Z11732432	184,97
M 2" BSP	F 1" 1/2 BSP	Z11733224	174,03

Adaptadores BSP

BSP Adaptors
Adaptateurs BSP
Adattatori BSP

Tapón reductor macho BSP 60° - hembra fija BSP

Reducer plug male BSP 60° - fixed female BSP

Bouchon réducteur mâle BSP cone 60° - femelle gaz

Tappo di riduzione maschio - femmina BSP 60°

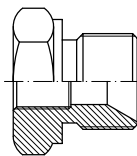

THREAD ROSCA		Part nº Referencia	€
M 1/4" BSP	F 1/8" BSP	Z11500402	9,72
M 3/8" BSP	F 1/8" BSP	Z11500602	14,58
M 3/8" BSP	F 1/4" BSP	Z11500604	14,76
M 1/2" BSP	F 1/4" BSP	Z11500804	16,73
M 1/2" BSP	F 3/8" BSP	Z11500806	16,00
M 3/4" BSP	F 1/2" BSP	Z11501208	19,01
M 1" BSP	F 1/2" BSP	Z11501608	31,40
M 1" BSP	F 3/4" BSP	Z11501612	29,50
M 1" 1/4 BSP	F 3/4" BSP	Z11502012	55,70
M 1" 1/4 BSP	F 1" BSP	Z11502016	51,15
M 1" 1/2 BSP	F 1" BSP	Z11502416	69,97
M 2" BSP	F 1" BSP	Z11503216	102,95
M 2" BSP	F 1 1/4" BSP	Z11503220 *	93,64
M 2" BSP	F 1 1/2" BSP	Z11503224	93,11

*Hasta fin de existencias. / *Until end of stock. / *Jusqu'à la fin du stock. / *Fino ad esaurimento scorta.

Tapón hembra hexagonal rosca BSP

BSP fixed female plug

Bouchon femelle gaz

Tappo femmina fissa BSP

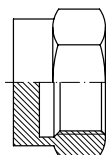

THREAD ROSCA	Part nº Referencia	€
1/4" BSP	Z107204	9,85
3/8" BSP	Z107206	11,31
1/2" BSP	Z107208	12,70
3/4" BSP	Z107212	19,60
1" BSP	Z107216	26,36
1" 1/4 BSP	Z107220	39,40
1" 1/2 BSP	Z107224	55,81
2" BSP	Z107232	84,52

Tapón macho hexagonal rosca BSP 60°

BSP male hexagonal plug

Bouchon mâle BSP cone 60°

Tappo maschio esagonale BSP

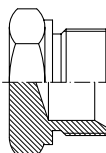

THREAD ROSCA	Part nº Referencia	€
1/8" BSP	Z107002	11,72
1/4" BSP	Z107004	7,44
3/8" BSP	Z107006	8,60
1/2" BSP	Z107008	10,25
3/4" BSP	Z107012	12,43
1" BSP	Z107016	25,70
1" 1/4 BSP	Z107020	41,02
1" 1/2 BSP	Z107024	65,24
2" BSP	Z107032	66,65

Tapón hembra giratoria BSP cono 60°

BSP swivel female plug

Bouchon femelle tournante BSP cone 60°

Tappo femmina girevole BSP

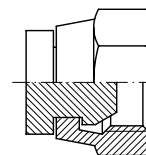

THREAD ROSCA	Part nº Referencia	€
1/4" BSP	Z107504	8,70
3/8" BSP	Z107506	11,18
1/2" BSP	Z107508	13,49
3/4" BSP	Z107512	19,32
1" BSP	Z107516	30,61
1" 1/4 BSP	Z107520	49,26
1" 1/2 BSP	Z107524	86,60
2" BSP	Z107532	129,24

Adaptadores BSP

BSP Adaptors
Adaptateurs BSP
Adattatori BSP

Crimping fittings for hoses

Pipe fittings

Pipe fittings II

Adaptors

Welding fittings

Industrial fittings

Accessories

Control components

Flow measuring

Tr/Mc LOK

Manguito redondo roscado hembra BSP

Adaptor female fixed BSP - female fixed BSP

Manchon femelle gaz ronde

Manicotto femmina - femmina BSP

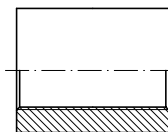

THREAD ROSCA	Part n° Referencia	€
1/8" BSP	Z131002	9,21
1/4" BSP	Z131004	9,08
3/8" BSP	Z131006	13,77
1/2" BSP	Z131008	17,23
5/8" BSP	Z131010	23,20
3/4" BSP	Z131012	23,81
1" BSP	Z131016	33,75
1"1/4 BSP	Z131020	47,93
1"1/2 BSP	Z131024	62,78
2" BSP	Z131032	86,88

Manguito hexagonal roscado hembra BSP

Adaptor hexagonal female fixed BSP - female fixed BSP

Manchon femelle gaz - femelle gaz hexagone

Prolunga esagonale femmina - femmina BSP

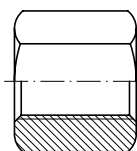

THREAD ROSCA	Part n° Referencia	€
1/4" BSP	Z103104	8,26
3/8" BSP	Z103106	10,55
1/2" BSP	Z103108	15,13
3/4" BSP	Z103112	23,16
1" BSP	Z103116	34,85
1"1/4 BSP	Z103120	71,29
1"1/2 BSP	Z103124	79,30

Tornillo orientable simple BSP

BSP Bolt for banjo

Vis creuse simple pour banjo gaz

Bullone forato BSP

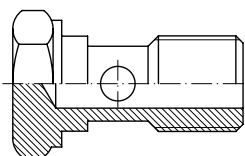

THREAD ROSCA	Part n° Referencia	€
1/4" BSP	Z109004	10,99
3/8" BSP	Z109006	15,83
1/2" BSP	Z109008	21,08
3/4" BSP	Z109012	35,40
1" BSP	Z109016	48,13

Pasatabiques sin tuerca BSP cono 60°

Straight bulkhead adaptor BSP 60° without nut

Passe-cloison mâle BSP 60° - mâle BSP 60° sans équiper

Niples passaparete BSP 60°

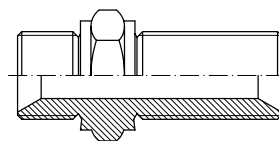

THREAD ROSCA	Part n° Referencia	€
1/4" BSP	Z116004	17,86
3/8" BSP	Z116006	20,65
1/2" BSP	Z116008	25,59
3/4" BSP	Z116012	34,30
1" BSP	Z116016	59,27
1" 1/4 BSP	Z116020	84,44
1" 1/2 BSP	Z116024	117,90
2" BSP	Z116032	167,76

Tuerca pasatabiques BSP

Conter nut for BSP bulkhead

Contre-écrou passe-cloison gaz

Controdado per passaparete

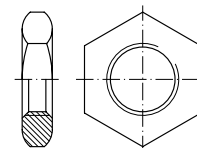

THREAD ROSCA	Part n° Referencia	€
1/4" BSP	Z116104	4,36
3/8" BSP	Z116106	6,07
1/2" BSP	Z116108	7,09
3/4" BSP	Z116112	10,13
1" BSP	Z116116	13,01
1" 1/4 BSP	Z116120	26,78
1" 1/2 BSP	Z116124	35,00
2" BSP	Z116132	43,50

Tornillo orientable simple Métrico

Metric bolt for banjo

Vis creuse simple for banjo Métrique

Bullone forato Metrico

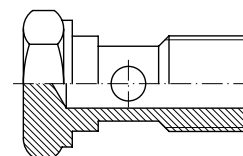

THREAD ROSCA	Part n° Referencia	€
M12X1.5	Z109212	15,90
M14X1.5	Z109214	15,06
M16X1.5	Z109216	16,06
M18X1.5	Z109218	19,82
M22X1.5	Z109222	19,95
M26X1.5	Z109226	41,25
M30X2	Z109230	47,11

Adaptadores BSP

BSP Adaptors
Adaptateurs BSP
Adattatori BSP

Juntas metal FKM Gas

BSP Bonded Seal FKM

Bague BS gaz FKM

Rondella Bonded FKM Gas

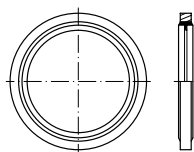

THREAD ROSCA	Part nº Referencia	€
1/8" BSP	ZVT21002	1,26
1/4" BSP	ZVT21004	1,04
3/8" BSP	ZVT21006	1,27
1/2" BSP	ZVT21008	2,07
5/8" BSP	ZVT21010	3,67
3/4" BSP	ZVT21012	2,71
1" BSP	ZVT21016	4,87
1" 1/4 BSP	ZVT21020	7,76
1" 1/2 BSP	ZVT21024	9,51
2" BSP	ZVT21032	12,57
2" 1/2 BSP	ZVT21040	35,10

Juntas metal FKM Métricas

Metric Bonded Seal in FKM

Bague BS Métrique FKM

Rondella Bonded FKM Metriche

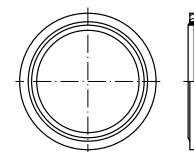

THREAD ROSCA	Part nº Referencia	€
M6X1	ZVT32006	0,55
M8X1	ZVT32008	1,30
M10X1	ZVT32010	1,55
M12X1,5	ZVT32012	1,40
M14X1,5	ZVT32014	1,83
M16X1,5	ZVT32016	1,97
M18X1,5	ZVT32018	2,09
M20X1,5	ZVT32020	3,12
M22X1,5	ZVT32022	2,70
M24X1,5	ZVT32024	5,22
M26X1,5	ZVT32026	5,12
M27X1,5	ZVT32027	5,11
M30X2	ZVT32030	7,34
M36X2	ZVT32036	8,99
M42X2	ZVT32042	13,32
M48X2	ZVT32048	14,64

Codo 90° macho - hembra giratoria BSP cono 60°

90° Elbow swivel female BSP 60° - male BSP 60°

Adaptateur coude 90° accessoirel mâle BSP - femelle tournante BSP cone 60°

Curva 90° maschio - femmina girevole BSP 60°

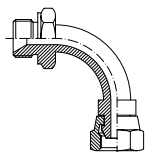

THREAD ROSCA	Part nº Referencia	€
M 1/4" BSP F 1/4" BSP	Z119404	45,16
M 3/8" BSP F 3/8" BSP	Z119406	51,34
M 1/2" BSP F 1/2" BSP	Z119408	62,83
M 3/4" BSP F 3/4" BSP	Z119412	89,56
M 1" BSP F 1" BSP	Z119416	104,37
M 1" 1/4 BSP F 1" 1/4 BSP	Z119420	167,56
M 1" 1/2 BSP F 1" 1/2 BSP	Z119424	238,48
M 2" BSP F 2" BSP	Z119432	361,90

Codo 45° macho - hembra giratoria BSP cono 60°

45° Elbow swivel female BSP 60° - male BSP 60°

Adaptateur coude 45° accessoirel mâle BSP - femelle tournante BSP cone 60°

Curva 45° maschio - femmina girevole BSP 60°

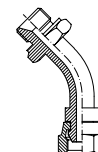

THREAD ROSCA	Part nº Referencia	€
M 1/4" BSP F 1/4" BSP	Z119504	49,67
M 3/8" BSP F 3/8" BSP	Z119506	51,37
M 1/2" BSP F 1/2" BSP	Z119508	64,53
M 3/4" BSP F 3/4" BSP	Z119512	79,80
M 1" BSP F 1" BSP	Z119516	103,65
M 1" 1/4 BSP F 1" 1/4 BSP	Z119520	201,17
M 1" 1/2 BSP F 1" 1/2 BSP	Z119524	259,89
M 2" BSP F 2" BSP	Z119532	443,56

Codo 90° hembra giratoria - hembra giratoria BSP cono 60°

90° Elbow swivel female BSP 60° - swivel female BSP 60°

Adaptateur coude 90° femelle tournante BSP - femelle tournante cone 60°

Curva 90° femmina - femmina girevole BSP 60°

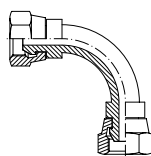

THREAD ROSCA	Part nº Referencia	€
1/4" BSP 1/4" BSP	ZA119604	37,78
3/8" BSP 3/8" BSP	ZA119606	42,58
1/2" BSP 1/2" BSP	ZA119608	51,95
3/4" BSP 3/4" BSP	ZA119612	65,52
1" BSP 1" BSP	ZA119616	101,32
1" 1/4 BSP 1" 1/4 BSP	ZA119620	170,45

Codo 45° hembra giratoria - hembra giratoria BSP cono 60°

45° Elbow swivel female BSP 60° - swivel female BSP 60°

Adaptateur coude 45° femelle tournante BSP - femelle tournante cone 60°

Curva 45° femmina girevole - femmina girevole BSP 60°

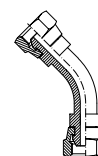

THREAD ROSCA	Part nº Referencia	€
1/4" BSP 1/4" BSP	ZA119504	43,32
3/8" BSP 3/8" BSP	ZA119506	47,57
1/2" BSP 1/2" BSP	ZA119508	55,66
3/4" BSP 3/4" BSP	ZA119512	71,77
1" BSP 1" BSP	ZA119516	100,25
1" 1/4 BSP 1" 1/4 BSP	ZA119520	235,53

Adaptadores BSP

BSP Adaptors
Adapteurs BSP
Adattatori BSP

Crimping fittings for hoses

Pipe fittings

Pipe fittings II

Adaptors

Welding fittings

Industrial fittings

Accessories

Control components

Flow measuring

TriLe LOK

Codo 90° macho - macho BSP cono 60°

90° Adaptor male - male BSP 60°

Adapteur coude 90° mâle BSP - mâle BSP cone 60° forge

Adattatore a 90° maschio - maschio BSP 60°

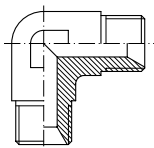

THREAD ROSCA		Part nº Referencia	€
1/8" BSP	1/8" BSP	Z1190002	28,15
1/4" BSP	1/4" BSP	Z1190004	27,03
3/8" BSP	3/8" BSP	Z1190006	31,02
1/2" BSP	1/2" BSP	Z1190008	37,37
3/4" BSP	3/4" BSP	Z1190012	57,11
1" BSP	1" BSP	Z1190016	84,82
1"1/4 BSP	1"1/4 BSP	Z1190020	145,58
1"1/2 BSP	1"1/2 BSP	Z1190024	173,82

Codo 90° macho BSP 60° - macho BSPT

90° Adaptor male BSP 60° - male BSPT

Adapteur coude 90° mâle BSP cone 60° - mâle gaz conique BSPT forge

Adattatore a 90° maschio BSP 60° - maschio BSPT

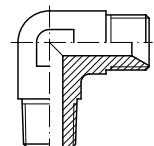

THREAD ROSCA		Part nº Referencia	€
1/8" BSP	1/8" BSPT	Z119202	25,47
1/4" BSP	1/4" BSPT	Z119204	22,39
3/8" BSP	3/8" BSPT	Z119206	31,60
1/2" BSP	1/2" BSPT	Z119208	40,26
3/4" BSP	3/4" BSPT	Z119212	57,21
1" BSP	1" BSPT	Z119216	83,66
1"1/4 BSP	1"1/4 BSPT	Z119220	132,68
1"1/2 BSP	1"1/2 BSPT	Z119224	180,15

Codo 90° regulable macho - macho BSP

90° Adjustable stud elbow male-male BSP

Coude 90° orientable mâle - mâle BSP

Adattatore a 90° orientabile maschio - maschio BSP

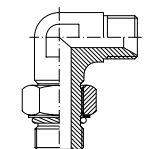

THREAD ROSCA		Part nº Referencia	€
1/4" BSP	1/4" BSP	Z119704	26,86
3/8" BSP	3/8" BSP	Z119706	38,79
1/2" BSP	1/2" BSP	Z119708	59,71
3/4" BSP	3/4" BSP	Z119712	82,22
1" BSP	1" BSP	Z119716	133,07

Codo 90° macho BSP 60° - macho NPT

90° Adaptor male BSP 60° - male NPT

Adapteur coude 90° mâle BSP 60° - mâle NPT forge

Adattatore a 90° maschio BSP 60° - maschio NPT

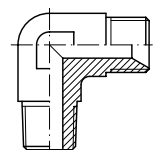

THREAD ROSCA		Part nº Referencia	€
1/4" BSP	1/4" NPT	Z11910404	27,16
3/8" BSP	3/8" NPT	Z11910606	37,82
1/2" BSP	1/2" NPT	Z11910808	40,16
3/4" BSP	3/4" NPT	Z11911212	64,05
1" BSP	1" NPT	Z11911616	80,86

Codo 90° macho - hembra giratoria BSP cono 60°

90° Adaptor male - swivel female BSP 60°

Adapteur coude 90° mâle BSP - femelle tournante BSP cone 60° forge

Adattatore a 90° maschio - femmina girevole BSP 60°

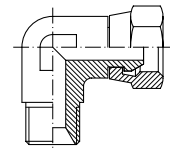

THREAD ROSCA		Part nº Referencia	€
M 1/8" BSP	F 1/8" BSP	Z119302	32,37
M 1/4" BSP	F 1/4" BSP	Z119304	27,17
M 3/8" BSP	F 3/8" BSP	Z119306	35,28
M 1/2" BSP	F 1/2" BSP	Z119308	42,99
M 3/4" BSP	F 3/4" BSP	Z119312	63,00
M 1" BSP	F 1" BSP	Z119316	86,44
M 1"1/4 BSP	F 1"1/4 BSP	Z119320	141,40
M 1"1/2 BSP	F 1"1/2 BSP	Z119324	154,11

Codo 90° hembra fija - hembra fija BSP

90° Adaptor fixed female BSP

Adapteur coude 90° femelle fixe gaz cylindrique forge

Adattatore a 90° femmina fissa BSP

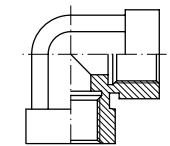

THREAD ROSCA		Part nº Referencia	€
1/8" BSP	1/8" BSP	Z119602	24,56
1/4" BSP	1/4" BSP	Z119604	30,75
3/8" BSP	3/8" BSP	Z119606	42,33
1/2" BSP	1/2" BSP	Z119608	44,70
3/4" BSP	3/4" BSP	Z119612	63,72
1" BSP	1" BSP	Z119616	88,18

Codo 90° hembra giratoria - hembra giratoria BSP cono 60°

90° Adaptor swivel female BSP 60°

Adapteur coude 90° femelle tournante BSP cone 60° forge

Adattatore a 90° femmina girevole BSP 60°

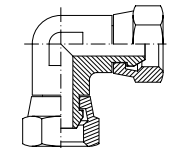

THREAD ROSCA		Part nº Referencia	€
1/4" BSP	1/4" BSP	Z119804	35,88
3/8" BSP	3/8" BSP	Z119806	42,83
1/2" BSP	1/2" BSP	Z119808	53,41
3/4" BSP	3/4" BSP	Z119812	79,39
1" BSP	1" BSP	Z119816	119,93
1"1/4 BSP	1"1/4 BSP	Z119820	218,85
1"1/2 BSP	1"1/2 BSP	Z119824	258,91

Codo 45° macho - hembra giratoria BSP cono 60°

45° Adaptor male - swivel female BSP 60°

Adapteur coude 45° mâle BSP - femelle tournante BSP cone 60° forge

Adattatore a 45° maschio - femmina girevole BSP 60°

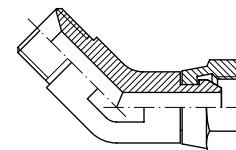

THREAD ROSCA		Part nº Referencia	€
M 1/4" BSP	F 1/4" BSP	Z118304	44,72
M 3/8" BSP	F 3/8" BSP	Z118306	53,36
M 1/2" BSP	F 1/2" BSP	Z118308	62,81
M 3/4" BSP	F 3/4" BSP	Z118312	101,60
M 1" BSP	F 1" BSP	Z118316	136,36

Adaptadores BSP

BSP Adaptors
Adaptateurs BSP
Adattatori BSP

Tes macho - macho - macho BSP cono 60°

Tees BSP 60° male

Adaptateurs Té mâle BSP cone 60° forge

Adattatore a T maschio BSP

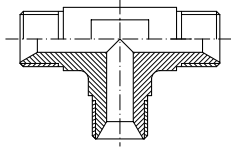

THREAD ROSCA			Part n° Referencia	€
1/4" BSP	1/4" BSP	1/4" BSP	Z122004	34,63
3/8" BSP	3/8" BSP	3/8" BSP	Z122006	43,76
1/2" BSP	1/2" BSP	1/2" BSP	Z122008	49,97
3/4" BSP	3/4" BSP	3/4" BSP	Z122012	71,20
1" BSP	1" BSP	1" BSP	Z122016	105,94
1"1/4" BSP	1"1/4" BSP	1"1/4" BSP	Z122020	159,02
1"1/2" BSP	1"1/2" BSP	1"1/2" BSP	Z122024	240,91

Tes macho - macho - hembra giratoria BSP 60°

Tees BSP 60° male - male - swivel female

Adaptateurs Té mâle BSP - mâle BSP - femelle tournante BSP cone 60° forge

Adattatore a T maschio - maschio - femmina girevole BSP

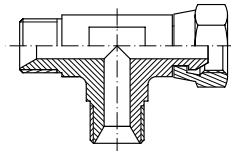

THREAD ROSCA			Part n° Referencia	€
M 1/4" BSP	M 1/4" BSP	F 1/4" BSP	Z122204	40,67
M 3/8" BSP	M 3/8" BSP	F 3/8" BSP	Z122206	50,61
M 1/2" BSP	M 1/2" BSP	F 1/2" BSP	Z122208	58,50
M 3/4" BSP	M 3/4" BSP	F 3/4" BSP	Z122212	89,06
M 1" BSP	M 1" BSP	F 1" BSP	Z122216	129,37
M 1"1/4" BSP	M 1"1/4" BSP	F 1"1/4" BSP	Z122220	191,54
M 1"1/2" BSP	M 1"1/2" BSP	F 1"1/2" BSP	Z122224	283,71

Tes macho - hembra giratoria - macho BSP 60°

Tees BSP 60° male - swivel female - male

Adaptateurs Té mâle BSP - femelle tournante - mâle BSP cone 60° forge

Adattatore a T maschio - femmina girevole - maschio BSP

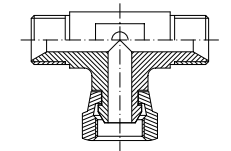

THREAD ROSCA			Part n° Referencia	€
M 1/4" BSP	F 1/4" BSP	M 1/4" BSP	Z122404	39,34
M 3/8" BSP	F 3/8" BSP	M 3/8" BSP	Z122406	50,61
M 1/2" BSP	F 1/2" BSP	M 1/2" BSP	Z122408	59,64
M 3/4" BSP	F 3/4" BSP	M 3/4" BSP	Z122412	89,80
M 1" BSP	F 1" BSP	M 1" BSP	Z122416	129,37
M 1"1/4" BSP	F 1"1/4" BSP	M 1"1/4" BSP	Z122420	183,03
M 1"1/2" BSP	F 1"1/2" BSP	M 1"1/2" BSP	Z122424	283,71

Tes hembras giratorias BSP cono 60°

Tees BSP 60° swivel female

Adaptateurs Té femelle tournante BSP cone 60° forge

Adattatore a T femmina - femmina - femmina girevoli BSP

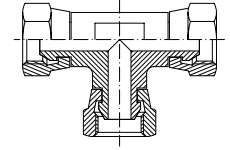

THREAD ROSCA			Part n° Referencia	€
1/4" BSP	1/4" BSP	1/4" BSP	Z122804	50,67
3/8" BSP	3/8" BSP	3/8" BSP	Z122806	60,47
1/2" BSP	1/2" BSP	1/2" BSP	Z122808	73,92
3/4" BSP	3/4" BSP	3/4" BSP	Z122812	117,01
1" BSP	1" BSP	1" BSP	Z122816	151,77
1"1/4" BSP	1"1/4" BSP	1"1/4" BSP	Z122820	268,00
1"1/2" BSP	1"1/2" BSP	1"1/2" BSP	Z122824	355,00

Tes hembras fijas BSP

Tees fixed female BSP

Adaptateurs Té femelle gaz forge

Adattatore a T femmina fissa BSP

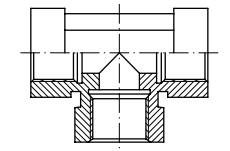

THREAD ROSCA			Part n° Referencia	€
1/4" BSP	1/4" BSP	1/4" BSP	Z122604	37,61
3/8" BSP	3/8" BSP	3/8" BSP	Z122606	51,00
1/2" BSP	1/2" BSP	1/2" BSP	Z122608	60,17
3/4" BSP	3/4" BSP	3/4" BSP	Z122612	86,56
1" BSP	1" BSP	1" BSP	Z122616	121,67

Tes macho BSP 60° - macho NPT central - macho BSP 60°

Tees BSP 60° male - NPT male center - BSP 60° male

Adaptateurs Té mâle BSP 60° - mâle NPT central - mâle BSP 60° forge

Adattatore a T maschio - maschio - maschio

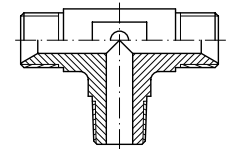

THREAD ROSCA			Part n° Referencia	€
1/4" BSP	1/4" NPT	1/4" BSP	Z12210404	33,12
3/8" BSP	3/8" NPT	3/8" BSP	Z12210606	44,75
1/2" BSP	1/2" NPT	1/2" BSP	Z12210808	65,06
3/4" BSP	3/4" NPT	3/4" BSP	Z12211212	76,78
1" BSP	1" NPT	1" BSP	Z12211616	114,25

Tes macho BSP 60° - macho BSP 60° - macho NPT lateral

Tees BSP 60° male - BSP 60° male - NPT male side

Adaptateurs Té mâle BSP 60° - mâle BSP 60° - mâle NPT latéral forge

Adattatore a T maschio - maschio - maschio

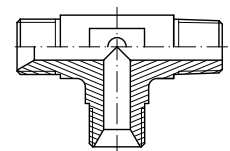

THREAD ROSCA			Part n° Referencia	€
1/4" BSP	1/4" BSP	1/4" NPT	Z12230404	32,12
3/8" BSP	3/8" BSP	3/8" NPT	Z12230606	44,75
1/2" BSP	1/2" BSP	1/2" NPT	Z12230808	65,06
3/4" BSP	3/4" BSP	3/4" NPT	Z12231212	76,78
1" BSP	1" BSP	1" NPT	Z12231616	114,25

Adaptadores NPT

NPT Adaptors
Adapteurs NPT
Adattatori NPT

Crimping fittings for hoses

Pipe fittings

Pipe fittings II

Adaptors

Welding fittings

Industrial fittings

Accessories

Control components

Flow measuring

Tri/Le LOK

Adaptor macho - macho NPT

Adaptor male NPT - male NPT

Adapteur mâle NPT - mâle NPT

Nipples di congiunzione NPT

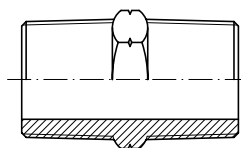

THREAD ROSCA		Part n° Referencia	€
1/4" NPT	1/4" NPT	Z10150404	8,26
3/8" NPT	3/8" NPT	Z10150606	11,64
1/2" NPT	1/2" NPT	Z10150808	11,55
3/4" NPT	3/4" NPT	Z10151212	18,30
1" NPT	1" NPT	Z10151616	42,73
1" 1/4 NPT	1" 1/4 NPT	Z10152020	56,34
1" 1/2 NPT	1" 1/2 NPT	Z10152424	70,75
2" NPT	2" NPT	Z10153232	108,18

Reductor macho - macho NPT

Reducer male NPT - male NPT

Réducteur mâle NPT - mâle NPT

Nipples di riduzione maschio - maschio NPT

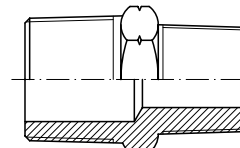

THREAD ROSCA		Part n° Referencia	€
1/4" NPT	1/8" NPT	ZN10150402	12,99
3/8" NPT	1/8" NPT	ZN10150602	16,91
3/8" NPT	1/4" NPT	ZN10150604	15,87
1/2" NPT	1/4" NPT	ZN10150804	21,57
1/2" NPT	3/8" NPT	ZN10150806	21,31
3/4" NPT	1/2" NPT	ZN10151208	22,20
1" NPT	1/2" NPT	ZN10151608	35,22
1" NPT	3/4" NPT	ZN10151612	39,74
1" 1/4 NPT	1" NPT	ZN10152016	70,82
1" 1/2 NPT	1" NPT	ZN10152416	98,34
1" 1/2 NPT	1" 1/4 NPT	ZN10152420	92,91
2" NPT	1" 1/2 NPT	ZN10153224	131,15

Adaptador macho - hembra fija NPT

Adaptor male NPT - fixed female NPT

Adapteur mâle NPT - femelle fixe NPT

Nipples di congiunzione maschio NPT - femmina fissa NPT

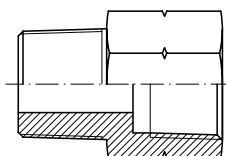

THREAD ROSCA		Part n° Referencia	€
M 1/8" NPT	F 1/8" NPT	ZN10600202	17,72
M 1/8" NPT	F 1/4" NPT	ZN10600204	19,02
M 1/4" NPT	F 1/8" NPT	ZN10600402	17,75
M 1/4" NPT	F 1/4" NPT	ZN10600404	14,79
M 1/4" NPT	F 3/8" NPT	ZN10600406	18,72
M 3/8" NPT	F 1/4" NPT	ZN10600604	18,40
M 3/8" NPT	F 3/8" NPT	ZN10600606	18,67
M 3/8" NPT	F 1/2" NPT	ZN10600608	23,77
M 1/2" NPT	F 3/8" NPT	ZN10600806	21,64
M 1/2" NPT	F 1/2" NPT	ZN10600808	24,20
M 1/2" NPT	F 3/4" NPT	ZN10600812	30,86
M 3/4" NPT	F 1/2" NPT	ZN10601208	30,19
M 3/4" NPT	F 3/4" NPT	ZN10601212	35,31
M 3/4" NPT	F 1" NPT	ZN10601216	41,07
M 1" NPT	F 3/4" NPT	ZN10601612	42,44
M 1" NPT	F 1" NPT	ZN10601616	42,39

Reductor macho - hembra fija NPT

Reducer male NPT - fixed female NPT

Réducteur mâle NPT - femelle fixe NPT

Nipples di riduzione maschio NPT - femmina fissa NPT

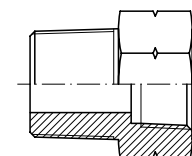

THREAD ROSCA		Part n° Referencia	€
M 3/8" NPT	F 1/8" NPT	ZN11500602	26,53
M 3/8" NPT	F 1/4" NPT	ZN11500604	22,64
M 1/2" NPT	F 1/4" NPT	ZN11500804	30,97
M 1/2" NPT	F 3/8" NPT	ZN11500806	26,04
M 3/4" NPT	F 1/4" NPT	ZN11501204	42,09
M 3/4" NPT	F 3/8" NPT	ZN11501206	54,53
M 3/4" NPT	F 1/2" NPT	ZN11501208	40,29
M 1" NPT	F 3/8" NPT	ZN11501606	66,99
M 1" NPT	F 1/2" NPT	ZN11501608	57,37
M 1" NPT	F 3/4" NPT	ZN11501612	49,16
M 1" 1/4 NPT	F 1" NPT	ZN11502016	90,27
M 1" 1/2 NPT	F 1" NPT	ZN11502416	162,41
M 1" 1/2 NPT	F 1" 1/4 NPT	ZN11502420	122,15

Adaptador macho NPT - hembra giratoria NPSM

Adaptor male NPT - swivel female NPSM

Adapteur mâle NPT - femelle tournante NPSM

Nipples di congiunzione maschio NPT - femmina girevole NPSM

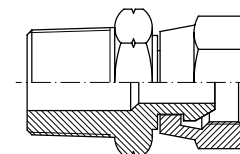

THREAD ROSCA		Part n° Referencia	€
M 1/8" NPT	F 1/8" NPSM	ZN11700202	19,95
M 1/4" NPT	F 1/4" NPSM	ZN11700404	21,87
M 3/8" NPT	F 3/8" NPSM	ZN11700606	25,62
M 3/8" NPT	F 1/2" NPSM	ZN11700608	36,19
M 1/2" NPT	F 1/2" NPSM	ZN11700808	50,08
M 1/2" NPT	F 3/4" NPSM	ZN11700812	54,90
M 3/4" NPT	F 3/4" NPSM	ZN11701212	48,46
M 1" NPT	F 1" NPSM	ZN11701616	68,05
M 1" 1/4 NPT	F 1" 1/4 NPSM	ZN11702020	111,18
M 1" 1/2 NPT	F 1" 1/2 NPSM	ZN11702424	138,75

Adaptadores NPT

NPT Adaptors
Adapteurs NPT
Adattatori NPT

Adaptador macho UNF - hembra giratoria NPSM

Adaptor male UNF - swivel female NPSM

Adapteur mâle UNF - femelle tournante NPSM

Nipples di giunzione maschio UNF - femmina girevole NPSM

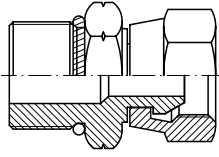

THREAD ROSCA		Part n° Referencia	€
M 7/16" - 20h UNF	F 1/4" - 18h NPSM	ZN11740404	52,14
M 9/16" - 18h UNF	F 3/8" - 18h NPSM	ZN11740606	56,90
M 9/16" - 18h UNF	F 1/2" - 14h NPSM	ZN11740608	76,56
M 3/4" - 16h UNF	F 1/2" - 14h NPSM	ZN11740808	70,77
M 3/4" - 16h UNF	F 3/4" - 14h NPSM	ZN11740812	110,39
M 7/8" - 14h UNF	F 1/2" - 14h NPSM	ZN11741008	84,09
M 7/8" - 14h UNF	F 3/4" - 14h NPSM	ZN11741012	111,92
M 1"1/16 - 12h UNF	F 3/4" - 14h NPSM	ZN11741212	123,22
M 1"5/16 - 12h UNF	F 1" - 11 1/2h NPSM	ZN11741616	150,35
M 1"5/8 - 12h UNF	F 1"1/4 - 11 1/2h NPSM	ZN11742020	241,28

Tapón hembra fija NPT

S.S. NPT fixed female plug

Bouchon femelle fixe NPT

Tappo femmina fissa NPT INOX

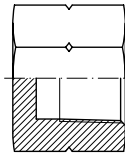

THREAD ROSCA	Part n° Referencia	€
1/8" NPT	ZN107202	12,88
1/4" NPT	ZN107204	15,26
3/8" NPT	ZN107206	18,02
1/2" NPT	ZN107208	21,35
3/4" NPT	ZN107212	26,50
1" NPT	ZN107216	33,02

Tapón macho NPT

S.S. NPT male plug

Bouchon mâle NPT

Tappo maschio NPT INOX

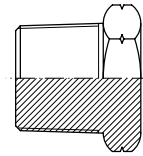

THREAD ROSCA	Part n° Referencia	€
1/8" NPT	ZN107002	5,90
1/4" NPT	ZN107004	8,67
3/8" NPT	ZN107006	11,76
1/2" NPT	ZN107008	12,37
3/4" NPT	ZN107012	14,58
1" NPT	ZN107016	23,50

Adaptador hexagonal hembra fija NPT

NPT hexagonal adaptor fixed female

Adapteur hexagonal femelle fixe NPT

Adattatore esagonale femmina fissa NPT

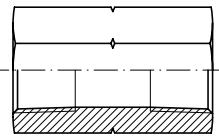

THREAD ROSCA		Part n° Referencia	€
1/8" NPT	1/8" NPT	ZN10310202	12,59
1/4" NPT	1/4" NPT	ZN10310404	15,67
3/8" NPT	3/8" NPT	ZN10310606	16,32
1/2" NPT	1/2" NPT	ZN10310808	19,68
3/4" NPT	3/4" NPT	ZN10311212	24,78
1" NPT	1" NPT	ZN10311616	35,30
1" 1/4 NPT	1" 1/4 NPT	ZN10312020	84,50

Adaptadores NPT

NPT Adaptors
Adaptateurs NPT
Adattatori NPT

Crimping fittings for hoses

Pipe fittings

Pipe fittings II

Adaptors

Welding fittings

Industrial fittings

Accessories

Control components

Flow measuring

Tri/Le LOK

Codo 90° macho - macho NPT

90° elbow male NPT - male NPT

Coude 90° mâle NPT - mâle NPT

Adattatore a 90° maschio - maschio NPT

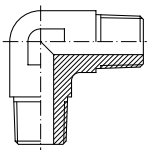

THREAD ROSCA		Part nº Referencia	€
1/8" NPT	1/8" NPT	ZN119002	18,10
1/4" NPT	1/4" NPT	ZN119004	21,00
3/8" NPT	3/8" NPT	ZN119006	28,90
1/2" NPT	1/2" NPT	ZN119008	37,43
3/4" NPT	3/4" NPT	ZN119012	63,70
1" NPT	1" NPT	ZN119016	84,50

Codo 90° macho NPT - hembra giratoria NPSM

90° elbow male NPT - swivel female NPSM

Coude 90° mâle NPT - femelle tournante NPSM

Adattatore a 90° maschio NPT - femmina girevole NPSM

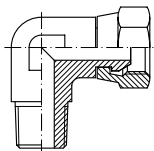

THREAD ROSCA		Part nº Referencia	€
M 1/8" NPT	F 1/8" 27h NPSM	ZN11930202	30,23
M 1/4" NPT	F 1/4" - 18h NPSM	ZN11930404	31,88
M 1/4" NPT	F 3/8" - 18h NPSM	ZN11930406	*
M 3/8" NPT	F 3/8" - 18h NPSM	ZN11930606	50,81
M 3/8" NPT	F 1/2" - 14h NPSM	ZN11930608	*
M 1/2" NPT	F 1/2" - 14 NPSM	ZN11930808	56,17
M 1/2" NPT	F 3/4" - 14h NPSM	ZN11930812	*
M 3/4" NPT	F 1/2" - 14 NPSM	ZN11931208	*
M 3/4" NPT	F 3/4" - 14h NPSM	ZN11931212	70,45
M 3/4" NPT	F 1" - 11 1/2 h NPSM	ZN11931216	*
M 1" NPT	F 1" - 11 1/2 h NPSM	ZN11931616	98,42
M 1 1/4" NPT	F 1 1/4" - 11 1/2 h NPSM	ZN11932020	125,33

Tes macho-macho-macho NPT

NPT male tee

Té mâle NPT

Adattatore a T maschio-maschio-maschio NPT

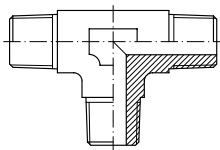

THREAD ROSCA			Part nº Referencia	€
1/8" NPT	1/8" NPT	1/8" NPT	ZN122002	26,49
1/4" NPT	1/4" NPT	1/4" NPT	ZN122004	42,42
3/8" NPT	3/8" NPT	3/8" NPT	ZN122006	46,94
1/2" NPT	1/2" NPT	1/2" NPT	ZN122008	57,01
3/4" NPT	3/4" NPT	3/4" NPT	ZN122012	79,53
1" NPT	1" NPT	1" NPT	ZN122016	129,76

Codo 90° hembra fija - hembra fija NPT

90° elbow fixed female NPT - fixed female NPT

Coude 90° femelle fixe NPT - femelle fixe NPT

Adattatore a 90° femmina fissa - femmina fissa NPT

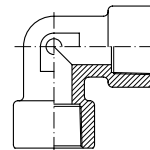

THREAD ROSCA		Part nº Referencia	€
1/8" NPT	1/8" NPT	ZN11960202	22,14
1/4" NPT	1/4" NPT	ZN11960404	30,62
3/8" NPT	3/8" NPT	ZN11960606	32,46
1/2" NPT	1/2" NPT	ZN11960808	52,80
3/4" NPT	3/4" NPT	ZN11961212	70,43
1" NPT	1" NPT	ZN11961616	105,84

Codo 45° macho NPT - hembra giratoria NPSM

45° elbow male NPT - swivel female NPS

Coude 45° mâle NPT - swivel female NPSM

Adattatore a 45° maschio NPT - femmina girevole NPSM

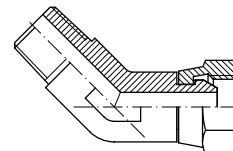

THREAD ROSCA		Part nº Referencia	€
M 1/4" NPT	F 1/4" - 18h NPSM	ZN139304	92,02
M 3/8" NPT	F 3/8" - 18h NPSM	ZN139306	96,38
M 1/2" NPT	F 1/2" - 14h NPSM	ZN139308	118,96
M 3/4" NPT	F 3/4" - 14h NPSM	ZN139312	162,91
M 1" NPT	F 1" - 11 1/2 h NPSM	ZN139316	248,61

Tes hembra fija-hembra fija-hembra fija NPT

NPT fixed female tee

Té femelle fixe NPT

Adattatore a T femmina fissa-femmina fissa-femmina fissa NPT

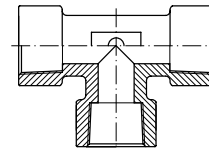

THREAD ROSCA			Part nº Referencia	€
1/8" NPT	1/8" NPT	1/8" NPT	ZN122602	26,72
1/4" NPT	1/4" NPT	1/4" NPT	ZN122604	40,12
3/8" NPT	3/8" NPT	3/8" NPT	ZN122606	54,62
1/2" NPT	1/2" NPT	1/2" NPT	ZN122608	63,00
3/4" NPT	3/4" NPT	3/4" NPT	ZN122612	97,33
1" NPT	1" NPT	1" NPT	ZN122616	142,85

Adaptadores O'Ring Boss

O'Ring Boss Adaptors
Adapteurs O'Ring Boss
Adattatori O'Ring Boss

Adaptador macho - macho O'Ring Boss

Adaptor male - male O'Ring Boss

Adapteur mâle - mâle O'Ring Boss

Adattatore maschio-maschio o-ring Boss

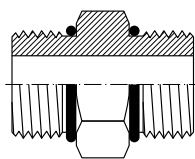

PIPE TUBO		THREAD ROSCA		Part nº Referencia	€
6	1/4	7/16"-20h UNF	7/16"-20h UNF	ZS64640606	10,51
8	5/16	1/2"-20h UNF	1/2"-20h UNF	ZS64640808	10,14
10	3/8	9/16"-18h UNF	9/16"-18h UNF	ZS64641010	10,59
12	1/2	3/4"-16h UNF	3/4"-16h UNF	ZS64641212	17,54
14-15-16	5/8	7/8"-14h UNF	7/8"-14h UNF	ZS64641616	18,62
18-20	3/4	1"1/16-12h UN	1"1/16-12h UN	ZS64642020	26,35
25	1	1"5/16-12h UN	1"5/16-12h UN	ZS64642525	31,67

Adaptador macho O'Ring Boss - macho JIC 37°

Adaptor male O'Ring Boss - male JIC 37°

Adapteur mâle O'Ring Boss - mâle JIC 37°

Adattatore maschio o-ring Boss - maschio JIC 37°

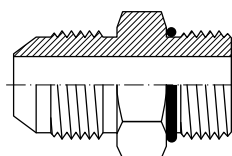

PIPE TUBO		THREAD ROSCA		Part nº Referencia	€
6	1/4	7/16"-20h UNF	7/16"-20h UNF	ZS22006	15,51
8	5/16	1/2"-20h UNF	1/2"-20h UNF	ZS22008	14,39
10	3/8	9/16"-18h UNF	9/16"-18h UNF	ZS22010	13,70
12	1/2	3/4"-16h UNF	3/4"-16h UNF	ZS22012	21,36
14-15-16	5/8	7/8"-14h UNF	7/8"-14h UNF	ZS22016	23,65
18-20	3/4	1"1/16-12h UN	1"1/16-12h UN	ZS22020	32,14
25	1	1"5/16-12h UN	1"5/16-12h UN	ZS22025	52,49
30-32	1 1/4	1"5/8-12h UN	1"5/8-12h UN	ZS22032	86,72
38	1 1/2	1"7/8-12h UN	1"7/8-12h UN	ZS22038	105,14

Adaptador macho O'Ring Boss - hembra giratoria JIC 37°

Adaptor male O'Ring Boss - swivel female JIC 37°

Adapteur mâle O'Ring Boss - femelle tournante JIC 37°

Adattatore maschio o-ring Boss - femmina gir. JIC 37°

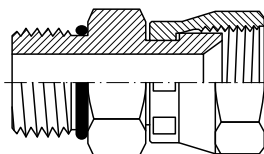

PIPE TUBO		THREAD ROSCA		Part nº Referencia	€
6	1/4	F 7/16" 20h UNF	M 7/16" 20h UNF	ZS38006	17,28
10	3/8	F 9/16" 18h UNF	M 9/16" 18h UNF	ZS38010	21,99
12	1/2	F 3/4" 16h UNF	M 3/4" 16h UNF	ZS38012	29,02
14-15-16	5/8	F 7/8" 14h UNF	M 7/8" 14h UNF	ZS38016	31,61
18-20	3/4	F 1"1/16 12h UN	M 1"1/16 12h UN	ZS38020	42,77
25	1	F 1"5/16 12h UN	M 1"5/16 12h UN	ZS38025	61,01

Adaptador macho O'Ring Boss - macho regulable O'Ring Boss

Adaptor male O'Ring Boss - adjustable male O'Ring Boss

Adapteur mâle O'Ring Boss - mâle réglable O'Ring Boss

Adattatore maschio o-ring Boss - maschio regolabile o-ring Boss

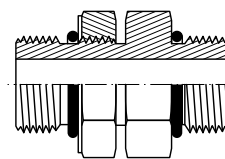

PIPE TUBO		THREAD ROSCA		Part nº Referencia	€
6	1/4	7/16"-20h UNF	7/16"-20h UNF	ZS34740606	21,12
10	3/8	9/16"-18h UNF	9/16"-18h UNF	ZS34741010	28,81
12	1/2	3/4"-16h UNF	3/4"-16h UNF	ZS34741212	36,20
14-15-16	5/8	7/8"-14h UNF	7/8"-14h UNF	ZS34741616	47,47
18-20	3/4	1"1/16-12h UN	1"1/16-12h UN	ZS34742020	85,48
25	1	1"5/16-12h UN	1"5/16-12h UN	ZS34742525	120,67

Adaptador macho O'Ring Boss - macho NPT

Adaptor male O'Ring Boss - male NPT

Adapteur mâle O'Ring Boss - mâle NPT

Adattatore maschio o-ring Boss - maschio NPT

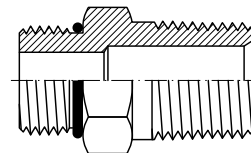

PIPE TUBO		THREAD ROSCA		Part nº Referencia	€
6	1/4	7/16"-20h UNF	1/4" NPT	ZS64010613	10,40
10	3/8	9/16"-18h UNF	3/8" NPT	ZS64011017	11,49
12	1/2	3/4"-16h UNF	1/2" NPT	ZS64011221	15,38
14-15-16	5/8	7/8"-14h UNF	1/2" NPT	ZS64011621	24,49
18-20	3/4	1"1/16-12h UN	3/4" NPT	ZS64012026	30,35
25	1	1"5/16-12h UN	1" NPT	ZS64012533	38,72

Prolongador macho O'Ring Boss - hembra fija NPT

Adaptor male O'Ring Boss - fixed female NPT

Prolongateur mâle O'Ring Boss - femelle fixe NPT

Prolunga machio o-ring Boss - femmina fissa NPT

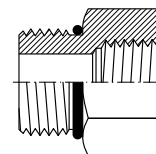

PIPE TUBO		THREAD ROSCA		Part nº Referencia	€
6	1/4	7/16"-20h UNF	1/4" NPT	ZS64050613	20,34
10	3/8	9/16"-18h UNF	3/8" NPT	ZS64051017	23,78
12	1/2	3/4"-16h UNF	1/2" NPT	ZS64051221	34,82
14-15-16	5/8	7/8"-14h UNF	1/2" NPT	ZS64051621	37,93
18-20	3/4	1"1/16-12h UN	3/4" NPT	ZS64052026	53,37
25	1	1"5/16-12h UN	1" NPT	ZS64052533	76,14

Adaptadores O'Ring Boss

O'Ring Boss Adaptors
Adaptateurs O'Ring Boss
Adattatori O'Ring Boss

Crimping fittings for hoses

Pipe fittings

Pipe fittings II

Adaptors

Welding fittings

Industrial fittings

Accessories

Control components

Flow measuring

Tri/Le LOK

Tapón macho O'Ring Boss hexagonal

Male hexagonal O'Ring Boss plug

Bouchon mâle O'Ring Boss hexagonal

Tappo maschio o-ring Boss testa esagonale

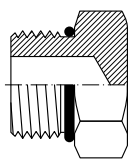

THREAD ROSCA	Part nº Referencia	€
7/16" - 20h UNF	ZS640806	13,63
1/2" - 20h UNF	ZS640808	8,43
9/16" - 18h UNF	ZS640810	13,52
3/4" - 16h UNF	ZS640812	11,39
7/8" - 14h UNF	ZS640816	17,05
1"1/16 - 12h UN	ZS640820	23,47
1"5/16 - 12h UN	ZS640825	31,74

Tapón macho O'Ring Boss Allen

Male allen O'Ring Boss plug

Bouchon mâle O'Ring Boss allen

Tappo maschio o-ring Boss esagono incassato

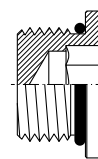

THREAD ROSCA	Part nº Referencia	€
7/16" - 20h UNF	ZS640906	10,43
1/2" - 20h UNF	ZS640908	13,50
9/16" - 18h UNF	ZS640910	12,16
3/4" - 16h UNF	ZS640912	15,36
7/8" - 14h UNF	ZS640916	17,13
1"1/16 - 12h UN	ZS640920	25,34
1"5/16 - 12h UN	ZS640925	32,96

Codo 90° regulable macho O'Ring Boss - macho JIC 37°

90° Adjustable elbow male O'Ring Boss - male JIC 37°

Coude 90° orientable mâle O'Ring Boss - mâle JIC 37°

Curva a 90° regolabile maschio o-ring Boss - maschio JIC 37°

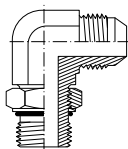

PIPE TUBO	THREAD ROSCA	Part nº Referencia	€
6	1/4	7/16" - 20h UNF / 7/16" - 20h UNF	ZS57506 / 22,53
8	5/16	1/2" - 20h UNF / 1/2" - 20h UNF	ZS57508 / 24,93
10	3/8	9/16" - 18h UNF / 9/16" - 18h UNF	ZS57510 / 27,84
12	1/2	3/4" - 16h UNF / 3/4" - 16h UNF	ZS57512 / 45,52
14-15-16	5/8	7/8" - 14h UNF / 7/8" - 14h UNF	ZS57516 / 58,94
18-20	3/4	1" 1/16 - 12h UN / 1" 1/16 - 12h UN	ZS57520 / 86,63
25	1	1" 5/16 - 12h UN / 1" 5/16 - 12h UN	ZS57525 / 129,62

Te regulable macho O'Ring Boss - macho JIC 37° - macho JIC 37°

Adjustable Tee male O'Ring Boss - male JIC 37° - male JIC 37°

Té orientable macho O'Ring Boss - macho JIC 37° - macho JIC 37°

Tee regolabile maschio o-ring Boss - maschio JIC 37° - maschio JIC 37°

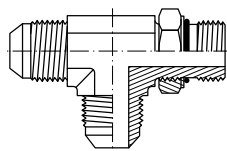

PIPE TUBO	THREAD ROSCA	Part nº Referencia	€
6	1/4	7/16" - 20h UNF	ZS680306 *
8	5/16	1/2" - 20h UNF	ZS680308 *
10	3/8	9/16" - 18h UNF	ZS680310 *
12	1/2	3/4" - 16h UNF	ZS680312 *
14-15-16	5/8	7/8" 14h UNF	ZS680316 *
18-20	3/4	1"1/16-12h UN	ZS680320 *
25	1	1" 5/16-12h UN	ZS680325 *

Te regulable macho JIC 37° - macho O'Ring Boss - macho JIC 37°

Adjustable Tee male JIC 37° - male O'Ring Boss - male JIC 37°

Té orientable macho JIC 37° - macho O'Ring Boss - macho JIC 37°

Tee regolabile maschio JIC 37° - maschio o-ring Boss - maschio JIC 37°

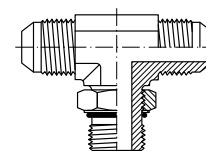

PIPE TUBO	THREAD ROSCA	Part nº Referencia	€
6	1/4	7/16" - 20h UNF	ZS680406 *
8	5/16	1/2"-20h UNF	ZS680408 *
10	3/8	9/16" - 18h UNF	ZS680410 *
12	1/2	3/4" - 16h UNF	ZS680412 *
14-15-16	5/8	7/8" 14h UNF	ZS680416 *
18-20	3/4	1"1/16-12h UN	ZS680420 *
25	1	1" 5/16-12h UN	ZS680425 *

Adaptadores ORFS

ORFS Adaptors
Adaptateurs ORFS
Adattatori ORFS

Tuerca ORFS

ORFS Nut

Écrou ORFS

Dado ORFS

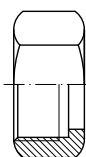

PIPE TUBO	THREAD ROSCA	Part nº Referencia	€
6-8	ORFS 9/16"-18h	ZOR1020400	11,63
10	ORFS 11/16"-16h	ZOR1020600	10,13
12	ORFS 13/16"-16h	ZOR1020800	12,32
14-15-16	ORFS 1"-14h	ZOR1021000	19,40
18-20	ORFS 1"3/16-12h	ZOR1021200	16,01
22-25	ORFS 1"7/16-12h	ZOR1021600	22,41
28-30-32	ORFS 1"11/16-12h	ZOR1022000	46,46
35-38	ORFS 2"-12h	ZOR1022400	54,80

Cono soldar ORFS

ORFS Welding nipple

Collet à souder ORFS

Ogiva a saldare ORFS

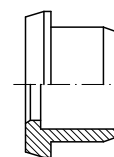

PIPE TUBO	THREAD ROSCA	Part nº Referencia	€
6	ORFS 9/16"-18h	ZOR12730406	8,49
8	ORFS 9/16"-18h	ZOR12730408	8,95
10	ORFS 11/16"-16h	ZOR12730610	9,45
12	ORFS 13/16"-16h	ZOR12730812	10,10
14	ORFS 1"-14h	ZOR12731014	12,60
15	ORFS 1"-14h	ZOR12731015	12,66
16	ORFS 1"-14h	ZOR12731016	13,24
18	ORFS 1" 3/16-12h	ZOR12731218	22,15
20	ORFS 1" 3/16-12h	ZOR12731220	22,15
22	ORFS 1" 7/16-12h	ZOR12731622	31,37
30	ORFS 1"11/16-12h	ZOR12732030	39,67
32	ORFS 1"11/16-12h	ZOR12732032	39,67
38	ORFS 2"-12h	ZOR12732438	72,08

Tapón macho ORFS

ORFS Male plug

Bouchon mâle ORFS

Tappo maschio ORFS

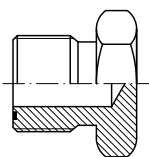

THREAD ROSCA	Part nº Referencia	€
ORFS 9/16"-18h	ZOR1040400	10,08
ORFS 11/16"-16h	ZOR1040600	13,45
ORFS 13/16"-16h	ZOR1040800	12,79
ORFS 1"-14h	ZOR1041000	18,84
ORFS 1"3/16-12h	ZOR1041200	25,49
ORFS 1"7/16-12h	ZOR1041600	42,22
ORFS 1"11/16-12h	ZOR1042000	53,98
ORFS 2"-12h	ZOR1042400	67,22

Tapón hembra ORFS

ORFS Female plug

Bouchon femelle ORFS

Tappo femmina ORFS

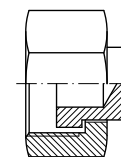

THREAD ROSCA	Part nº Referencia	€
ORFS 9/16"-18h	ZOR1050400	16,46
ORFS 11/16"-16h	ZOR1050600	17,39
ORFS 13/16"-16h	ZOR1050800	18,00
ORFS 1"-14h	ZOR1051000	23,41
ORFS 1"3/16-12h	ZOR1051200	41,40
ORFS 1"7/16-12h	ZOR1051600	50,55
ORFS 1"11/16-12h	ZOR1052000	66,27
ORFS 2"-12h	ZOR1052400	87,89

Adaptador macho-macho ORFS

ORFS Male adaptor

Adapteur mâle ORFS

Adattatore maschio ORFS

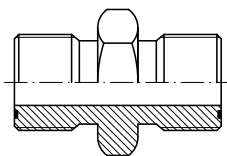

THREAD ROSCA	Part nº Referencia	€
ORFS 9/16"-18h	ZOR2000404	22,64
ORFS 11/16"-16h	ZOR2000606	23,02
ORFS 13/16"-16h	ZOR2000808	23,40
ORFS 1"-14h	ZOR2001010	40,24
ORFS 1"3/16-12h	ZOR2001212	32,53
ORFS 1"7/16-12h	ZOR2001616	50,27
ORFS 1"11/16-12h	ZOR2002020	68,08
ORFS 2"-12h	ZOR2002424	92,85

Adaptador macho ORFS-macho BSP

ORFS Male - BSP Male

Adapteur mâle ORFS - mâle BSP

Adattatore maschio ORFS-BSP

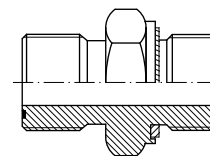

THREAD ROSCA	Part nº Referencia	€	
ORFS 9/16"-18h	BSP 1/4"	ZOR2020404	18,29
ORFS 11/16"-16h	BSP 3/8"	ZOR2020606	22,01
ORFS 13/16"-16h	BSP 1/2"	ZOR2020808	31,47
ORFS 1"3/16-12h	BSP 3/4"	ZOR2021212	44,11
ORFS 1"7/16-12h	BSP 1"	ZOR2021616	54,52
ORFS 1"11/16-12h	BSP 1" 1/4	ZOR2022020	92,09
ORFS 2"-12h	BSP 1" 1/2	ZOR2022424	129,77

Adaptadores ORFS

ORFS Adaptors
Adaptateurs ORFS
Adattatori ORFS

Adaptador macho ORFS-macho Métrico

ORFS Male - Metric Male

Adaptateur mâle ORFS - mâle Métrique

Maschio ORFS Metrico

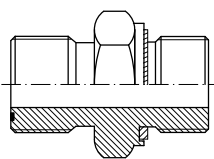

THREAD ROSCA		Part nº Referencia	€
ORFS 9/16"-18h	M12x1.5	ZOR10170412	21,76
ORFS 11/16"-16h	M16x1.5	ZOR10170616	23,42
ORFS 13/16"-16h	M18x1.5	ZOR10170818	34,96
ORFS 1"-14h	M22x1.5	ZOR10171022	47,11
ORFS 1"7/16-12h	M33x2	ZOR10171633	60,57
ORFS 1"11/16-12h	M42x2	ZOR10172042	98,38
ORFS 2"-12h	M48x2	ZOR10172448	144,19

Pasatabiques ORFS

ORFS Bulkhead

Passe-cloison ORFS

Passaparete ORFS

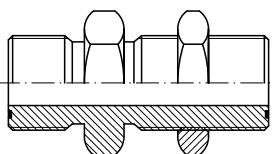

THREAD ROSCA	Part nº Referencia	€
ORFS 9/16"-18h	ZOR1060404	30,51
ORFS 11/16"-16h	ZOR1060606	40,58
ORFS 13/16"-16h	ZOR1060808	51,58
ORFS 1"-14h	ZOR1061010	86,69
ORFS 1"3/16-12h	ZOR1061212	99,87
ORFS 1"7/16-12h	ZOR1061616	119,81
ORFS 1"11/16-12h	ZOR1062020	140,20
ORFS 2"-12h	ZOR1062424	175,45

Adaptador macho-hembra giratoria ORFS

ORFS Male - ORFS Swivel female

Adaptateur mâle - femelle tournante ORFS

Adattatore femmina girevole ORFS-maschio ORFS

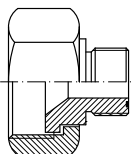

THREAD ROSCA		Part nº Referencia	€
F ORFS 9/16"-18h	M ORFS 11/16"-16h	ZOR3010406	24,46
F ORFS 11/16"-16h	M ORFS 9/16"-18h	ZOR3010604	26,59
F ORFS 13/16"-16h	M ORFS 9/16"-18h	ZOR3010804	27,40
F ORFS 13/16"-16h	M ORFS 11/16"-16h	ZOR3010806	27,54
F ORFS 1"-14h	M ORFS 9/16"-18h	ZOR3011004	39,04
F ORFS 1"-14h	M ORFS 11/16"-16h	ZOR3011006	38,27
F ORFS 1"-14h	M ORFS 13/16"-16h	ZOR3011008	34,42
F ORFS 1"3/16-12h	M ORFS 11/16"-16h	ZOR3011206	67,36
F ORFS 1"3/16-12h	M ORFS 13/16"-16h	ZOR3011208	65,86
F ORFS 1"3/16-12h	M ORFS 1"-14h	ZOR3011210	60,88
F ORFS 1"7/16-12h	M ORFS 13/16"-16h	ZOR3011608	74,35
F ORFS 1"7/16-12h	M ORFS 1"-14h	ZOR3011610	72,11
F ORFS 1"11/16-12h	M ORFS 1"3/16-12h	ZOR3012012	68,50
F ORFS 1"11/16-12h	M ORFS 1"7/16-12h	ZOR3012016	96,28

Adaptador macho ORFS-macho JIC 37°

ORFS Male - 37° JIC Male

Adaptateur mâle ORFS - mâle JIC 37°

Adattatore maschio ORFS-JIC

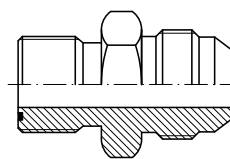

THREAD ROSCA		Part nº Referencia	€
ORFS 9/16"-18h	JIC 7/16"	ZOR2040404	16,81
ORFS 11/16"-16h	JIC 9/16"	ZOR2040606	19,44
ORFS 13/16"-16h	JIC 3/4"	ZOR2040808	21,40
ORFS 1"-14h	JIC 7/8"	ZOR2041010	23,29
ORFS 1"3/16-12h	JIC 1"1/16	ZOR2041212	28,62
ORFS 1"7/16-12h	JIC 1"5/16	ZOR2041616	45,16
ORFS 1"11/16"-12h	JIC 1"5/8	ZOR2042020	70,04
ORFS 2"-12h	JIC 1"7/8	ZOR2042424	100,27

Adaptador macho ORFS-hembra giratoria JIC 37°

ORFS Male - 37° JIC Swivel female

Adaptateur mâle ORFS - femelle tournante JIC 37°

Adattatore maschio ORFS-femmina girevole JIC

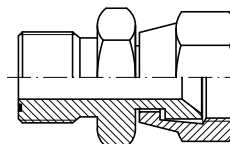

THREAD ROSCA		Part nº Referencia	€
ORFS 9/16"-18h	JIC 7/16"	ZOR3020404	21,05
ORFS 11/16"-16h	JIC 9/16"	ZOR3020606	22,65
ORFS 13/16"-16h	JIC 3/4"	ZOR3020808	24,97
ORFS 1"-14h	JIC 7/8"	ZOR3021010	32,64
ORFS 1"3/16-12h	JIC 1"1/16	ZOR3021212	40,31
ORFS 1"7/16-12h	JIC 1"5/16	ZOR3021616	54,48
ORFS 1"11/16-12h	JIC 1"5/8	ZOR3022020	68,52
ORFS 2"-12h	JIC 1"7/8	ZOR3022424	80,43

Adaptador macho JIC 37°-hembra giratoria ORFS

JIC Male - ORFS Swivel female

Adaptateur mâle JIC 37° - femelle tournante ORFS

Adattatore maschio JIC 37° -femmina girevole ORFS

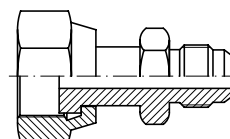

THREAD ROSCA		Part nº Referencia	€
JIC 7/16"	ORFS 9/16"-18h	ZOR3050404	22,65
JIC 9/16"	ORFS 11/16"-16h	ZOR3050606	25,23
JIC 3/4"	ORFS 13/16"-16h	ZOR3050808	27,35
JIC 7/8"	ORFS 1"-14h	ZOR3051010	35,80
JIC 1"1/16	ORFS 1"3/16"-12h	ZOR3051212	43,10
JIC 1"5/16"	ORFS 1"7/16"-12h	ZOR3051616	57,60
JIC 1"5/8	ORFS 1"11/16"-12h	ZOR3052020	70,80
JIC 1"7/8"	ORFS 2"-12h	ZOR3052424	86,80

Adaptadores ORFS

ORFS Adaptors
Adaptateurs ORFS
Adattatori ORFS

Codo 90° macho-macho ORFS

90° ORFS male - ORFS male

Coude 90° mâle ORFS - mâle ORFS

Raccordo a 90° maschio-ORFS

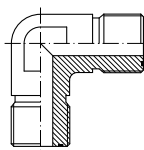

THREAD ROSCA		Part nº Referencia	€
ORFS 9/16"-18h	ORFS 9/16"-18h	ZOR4050404	33,30
ORFS 11/16"-16h	ORFS 11/16"-16h	ZOR4050606	40,21
ORFS 13/16"-16h	ORFS 13/16"-16h	ZOR4050808	55,64
ORFS 1"-14h	ORFS 1"-14h	ZOR4051010	62,11
ORFS 1"3/16-12h	ORFS 1"3/16-12h	ZOR4051212	71,44
ORFS 1"7/16-12h	ORFS 1"7/16-12h	ZOR4051616	99,60
ORFS 1"11/16-12h	ORFS 1"11/16-12h	ZOR4052020	151,34
ORFS 2"-12h	ORFS 2"-12h	ZOR4052424	174,68

Codo 90° macho-hembra giratoria ORFS

90° ORFS swivel female - ORFS male

Coude 90° femelle tournante ORFS- mâle ORFS

Raccordo a 90° maschio-femmina girevole ORFS

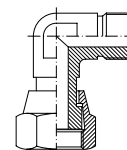

THREAD ROSCA		Part nº Referencia	€
M ORFS 9/16"-18h	F ORFS 9/16"-18h	ZOR6000404	49,00
M ORFS 11/16"-16h	F ORFS 11/16"-16h	ZOR6000606	61,28
M ORFS 13/16"-16h	F ORFS 13/16"-16h	ZOR6000808	80,18
M ORFS 1"-14h	F ORFS 1"-14h	ZOR6001010	86,48
M ORFS 1"3/16-12h	F ORFS 1"3/16-12h	ZOR6001212	107,00
M ORFS 1"7/16-12h	F ORFS 1"7/16-12h	ZOR6001616	121,94
M ORFS 1"11/16-12h	F ORFS 1"11/16-12h	ZOR6002020	149,90

Te macho-macho-macho ORFS

ORFS Male Tee

Té Mâle ORFS

Raccordo a T maschio ORFS

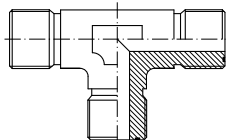

THREAD ROSCA	Part nº Referencia	€
ORFS 9/16"18h	ZOR7000404	43,75
ORFS 11/16"-16h	ZOR7000606	46,04
ORFS 13/16"-16h	ZOR7000808	57,94
ORFS 1"-14h	ZOR7001010	67,56
ORFS 1"3/16-12h	ZOR7001212	74,42
ORFS 1"7/16-12h	ZOR7001616	131,90
ORFS 1"11/16-12h	ZOR7002020	168,60
ORFS 2"-12h	ZOR7002424	223,13

Te macho-macho-hembra giratoria ORFS

ORFS Male-Male-Swivel Female Tee

Té Mâle-Mâle-Femelle tournante ORFS

Raccordo a T maschio-maschio-femmina girevole laterale ORFS

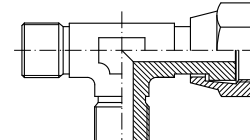

THREAD ROSCA	Part nº Referencia	€
ORFS 9/16"-18h	ZOR7020404	71,35
ORFS 11/16"-16h	ZOR7020606	75,86
ORFS 13/16"-16h	ZOR7020808	83,28
ORFS 1"-14h	ZOR7021010	115,12
ORFS 1"3/16-12h	ZOR7021212	144,10
ORFS 1"7/16-12h	ZOR7021616	187,15
ORFS 1" 11/16-12h	ZOR7022020	201,84

Te macho-hembra giratoria-macho ORFS

ORFS Male-Swivel female-Male Tee

Té Mâle-Femelle tournante-Mâle ORFS

Raccordo a T maschio-femmina girevole centrale-maschio ORFS

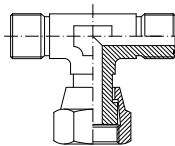

THREAD ROSCA	Part nº Referencia	€
ORFS 9/16"-18h	ZOR7010404	71,35
ORFS 11/16"-16h	ZOR7010606	72,94
ORFS 13/16"-16h	ZOR7010808	80,08
ORFS 1"-14h	ZOR7011010	115,12
ORFS 1"3/16-12h	ZOR7011212	138,56
ORFS 1"7/16-12h	ZOR7011616	187,15
ORFS 1"11/16-12h	ZOR7012020	201,84
ORFS 2"-12h	ZOR7012424	239,46

Juntas tóricas FKM verde para rosca ORFS

O'ring FKM green for ORFS thread

Joint torique FKM vert pour filetage ORFS

Guarnizione FKM verde per filetto ORFS



THREAD ROSCA	Part nº Referencia	€
ORFS 9/16"-18h	JVORFS04	0,47
ORFS 11/16"-16h	JVORFS06	0,52
ORFS 13/16"-16h	JVORFS08	0,58
ORFS 1"-14h	JVORFS10	0,66
ORFS 1"3/16-12h	JVORFS12	0,88
ORFS 1"7/16-12h	JVORFS16	1,38
ORFS 1" 11/16-12h	JVORFS20	1,74
ORFS 2"-12h	JVORFS24	2,07

Soldables

Welding fittings

Embouts à souder

Raccordi a saldare

Racores soldables

Welding fittings

Embouts à souder

Raccordi a saldare

173

Bridas soldables

Welding flanges

Brides à souder

Flange a saldare

181

5

Racores soldables

Welding fittings
Embouts à souder
Raccordi a saldare

■ Racores macho para soldar /Welding Male /Raccords mâle à souder /Maschio a saldare | 173

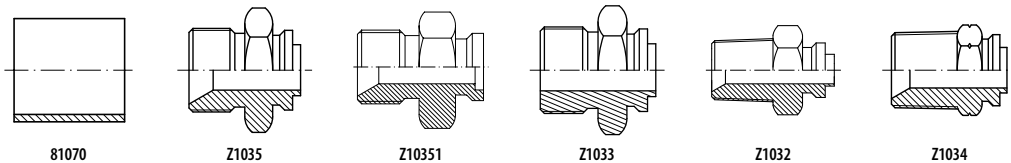

■ Racores BSP para soldar /Welding BSP nuts /Écrous tournants à souder /Raccordi BSP a saldare | 174

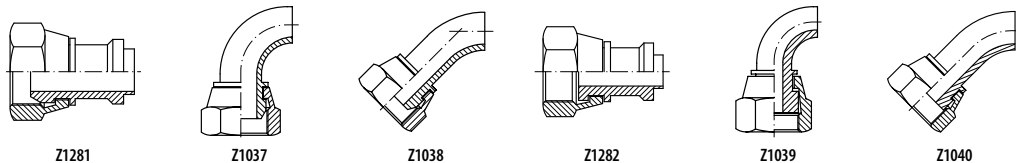

■ Racores JIC para soldar /Welding JIC fittings /Raccords JIC à souder /Raccordi JIC a saldare | 175

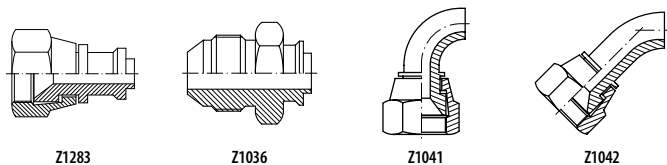

■ Racores Métricos para soldar /Welding metric fittings /Raccords métriques à souder /Raccordi metrici a saldare | 176

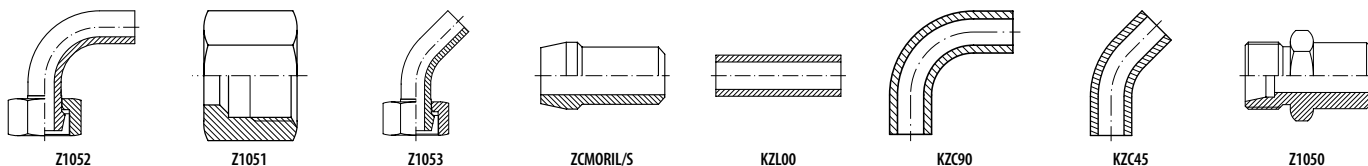

■ BSP >2" /Welding fittings >2" /Raccords à souder >2" /Raccordi a saldare > 2" | 178

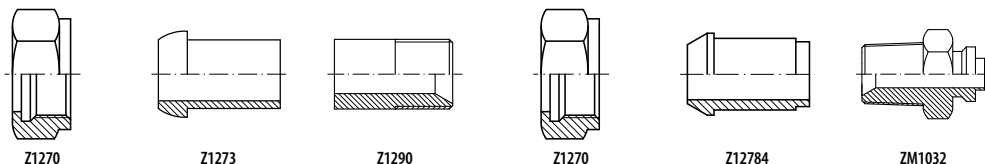

■ Racores Microfundido para soldar /Welding fittings microcast /Raccords à souder micro-moulés /Raccordi per saldatura microfuso | 179

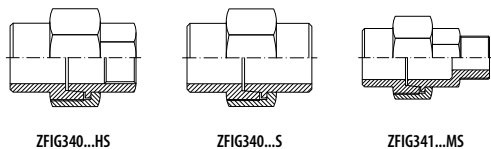

■ Conos ajuste BSP /Other welding BSP fittings /Autres raccords à souder BSP /Raccordi a saldare vari BSP | 180

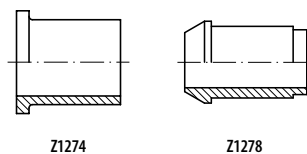

■ Conos ajuste JIC /Other welding JIC fittings /Autres raccords à souder JIC /Raccordi a saldare vari JIC | 180

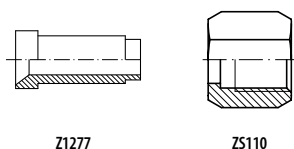

Bridas soldables

Welding flanges
Brides à souder
Flange a saldare

- Bridas fijas para soldar / Fixed Forged flanges / Brides DIN à souder fixes / Flange a saldare | 181

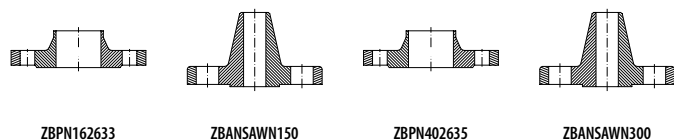

- Conjunto bridas DIN 2642 / DIN 2642 swivel flanges set / Ensemble brides tournantes DIN 2642 / Flangia girevole DIN 2642 | 182

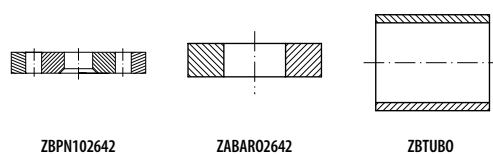

- Conjunto bridas DIN 2656 / DIN 2656 swivel flanges set / Ensemble brides tournantes DIN 2656 / Flangia girevole DIN 2656 | 183

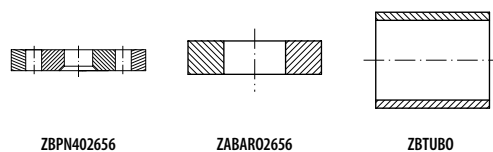

- Conjunto bridas ANSI-ASA / ANSI-ASA swivel flanges set / Ensemble brides ANSI-ASA / Flangia girevole ANSI-ASA | 184

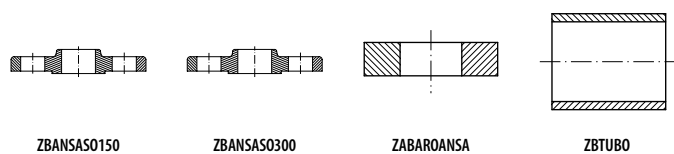

Racores soldables

Welding fittings
Embouts à souder
Raccordi a saldare

Casquillo soldable

Welding ferrule

Jupe à souder

Boccola a saldare

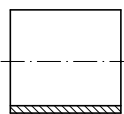

DN	Ø INNER Ø INT.	Part n° Referencia	€
1/4"	14	810700400	1,62
1/4"	12	810700401	1,62
3/8"	19	810700600	2,52
3/8"	17	810700601	1,85
1/2"	22	810700800	2,37
1/2"	19	810700801	2,37
5/8"	25	810701000	2,75
3/4"	30	810701200	2,92
3/4"	32	810701201	3,20
1"	35	810701500	3,35
1"	38	810701600	5,40
1"1/4	47,8	810702000	6,15
1"1/4	44,3	810702001	5,95
1"1/2	56,3	810702400	7,19
2"	66	810703201	11,20
2"1/2	84,9	810704000	15,03
2"1/2	95,6	810704001	22,50
3"	100	810704801	26,26
4"	125	810706400	34,81

Macho soldable BSP cono 60° con guía

Welding BSP 60° Male with guide

Mâle gaz BSP 60° à souder avec guide

Maschio a saldare BSP 60° con guida

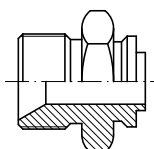

DN	THREAD ROSCA	Part n° Referencia	€
1/4"	1/4" BSP	Z103504	10,97
3/8"	3/8" BSP	Z103506	13,67
1/2"	1/2" BSP	Z103508	12,58
3/4"	3/4" BSP	Z103512	17,85
1"	1" BSP	Z103516	32,04
1"1/4	1"1/4 BSP	Z103520	48,44
1"1/2	1"1/2 BSP	Z103524	48,06
2"	2" BSP	Z103532	73,68

Macho BSP 60° soldable interior

Inside welding BSP Male

Mâle à souder int. BSP inox

Maschio BSP 60° a saldare interno

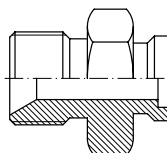

DN	THREAD ROSCA	Part n° Referencia	€
1/4"	1/4" BSP	Z1035104	14,36
3/8"	3/8" BSP	Z1035106	15,69
1/2"	1/2" BSP	Z1035108	18,08
3/4"	3/4" BSP	Z1035112	21,61
1"	1" BSP	Z1035116	31,71
1"1/4	1"1/4 BSP	Z1035120	52,00
1"1/2	1"1/2 BSP	Z1035124	60,26
2"	2" BSP	Z1035132	87,93

Macho soldable BSP asiento plano con guía

Welding BSP Male flat seat with guide

Mâle gaz BSP fond plat à souder avec guide

Maschio a saldare BSP faccia piana con guida

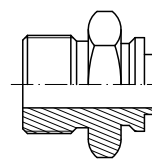

DN	THREAD ROSCA	Part n° Referencia	€
1/4"	1/4" BSP	Z103304	13,09
3/8"	3/8" BSP	Z103306	13,43
1/2"	1/2" BSP	Z103308	14,39
3/4"	3/4" BSP	Z103312	21,24
1"	1" BSP	Z103316	30,89
1"1/4	1"1/4 BSP	Z103320	49,83
1"1/2	1"1/2 BSP	Z103324	56,33
2"	2" BSP	Z103332	87,98

Macho soldable BSPT cono 60° con guía

Welding BSPT Male 60° with guide

Mâle gaz conique à souder 60° avec guide

Maschio conico BSPT 60° con guida

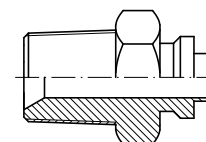

DN	THREAD ROSCA	Part n° Referencia	€
1/4"	1/4" BSPT	Z103204	12,35
3/8"	3/8" BSPT	Z103206	12,32
1/2"	1/2" BSPT	Z103208	13,27
3/4"	3/4" BSPT	Z103212	18,92
1"	1" BSPT	Z103216	26,46
1"1/4	1"1/4 BSPT	Z103220	41,85
1"1/2	1"1/2 BSPT	Z103224	49,71
2"	2" BSPT	Z103232	84,61

Macho soldable NPT cono 60° con guía

Welding NPT Male 60° with guide

Mâle NPT à souder 60° avec guide

Maschio a saldare NPT 60° con guida

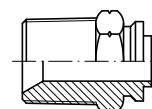

DN	THREAD ROSCA	Part n° Referencia	€
1/4"	1/4" NPT	Z10340400	10,89
3/8"	3/8" NPT	Z10340600	14,07
1/2"	1/2" NPT	Z10340800	13,59
3/4"	3/4" NPT	Z10341200	20,18
1"	1" NPT	Z10341600	28,77
1"1/4	1"1/4 NPT	Z10342000	49,21
1"1/2	1"1/2 NPT	Z10342400	55,74
2"	2" NPT	Z10343200	92,74

Racores soldables

Welding fittings
Embouts à souder
Raccordi a saldare

Hembra giratoria prensada soldable BSP 60° con guía

Welding BSP 60° swept with guide

Femelle tournante BSP 60° à souder avec guide

Femmina girevole a saldare BSP 60° con guida

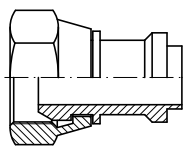

DN	THREAD ROSCA	Part n° Referencia	€
1/4"	1/4" BSP	Z128104	10,47
3/8"	3/8" BSP	Z128106	11,45
1/2"	1/2" BSP	Z128108	13,94
3/4"	3/4" BSP	Z128112	17,98
1"	1" BSP	Z128116	29,51
1"1/4	1"1/4 BSP	Z128120	55,54
1"1/2	1"1/2 BSP	Z128124	62,91
2"	2" BSP	Z128132	102,28

Hembra giratoria 90° prensada soldable BSP 60°

Welding BSP 60° swept 90°

Femelle tournante à souder 90° BSP cône 60°

Femmina girevole 90° a saldare BSP 60°

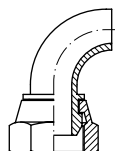

DN	THREAD ROSCA	Part n° Referencia	€
1/4"	1/4" BSP	Z103704	26,65
3/8"	3/8" BSP	Z103706	31,40
1/2"	1/2" BSP	Z103708	37,06
3/4"	3/4" BSP	Z103712	54,80
1"	1" BSP	Z103716	67,68
1"1/4	1"1/4 BSP	Z103720	109,60
1"1/2	1"1/2 BSP	Z103724	144,74
2"	2" BSP	Z103732	153,18

Hembra giratoria 45° prensada soldable BSP 60°

Welding BSP 60° swept 45°

Femelle tournante à souder 45° BSP cône 60°

Femmina girevole 45° a saldare BSP 60°

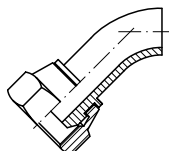

DN	THREAD ROSCA	Part n° Referencia	€
1/4"	1/4" BSP	Z103804	26,99
3/8"	3/8" BSP	Z103806	32,25
1/2"	1/2" BSP	Z103808	40,54
3/4"	3/4" BSP	Z103812	47,79
1"	1" BSP	Z103816	65,01
1"1/4	1"1/4 BSP	Z103820	112,01
1"1/2	1"1/2 BSP	Z103824	124,01
2"	2" BSP	Z103832	145,00

Hembra giratoria prensada soldable BSP asiento plano con guía

Welding BSP flat seat swept with guide

Femelle tournante BSP fond plat à souder avec guide

Femmina girevole a saldare BSP faccia piana con guida

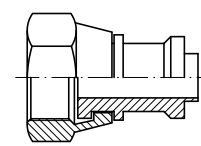

DN	THREAD ROSCA	Part n° Referencia	€
1/4"	1/4" BSP	Z128204	10,52
3/8"	3/8" BSP	Z128206	13,19
1/2"	1/2" BSP	Z128208	13,91
3/4"	3/4" BSP	Z128212	16,00
1"	1" BSP	Z128216	26,79
1"1/4	1"1/4 BSP	Z128220	53,35
1"1/2	1"1/2 BSP	Z128224	78,21
2"	2" BSP	Z128232	109,83

Hembra giratoria 90° prensada soldable BSP asiento plano

Welding BSP Female 90° flat seat swept

Femelle tournante à souder 90° BSP fond plat

Femmina 90° girevole a saldare BSP faccia piana



DN	THREAD ROSCA	Part n° Referencia	€
1/4"	1/4" BSP	Z103904	33,82
3/8"	3/8" BSP	Z103906	39,71
1/2"	1/2" BSP	Z103908	33,30
3/4"	3/4" BSP	Z103912	54,64
1"	1" BSP	Z103916	63,42
1"1/4	1"1/4 BSP	Z103920	105,96
1"1/2	1"1/2 BSP	Z103924	150,21
2"	2" BSP	Z103932	162,02

Hembra giratoria 45° prensada soldable BSP asiento plano

Welding BSP Female 45° flat seat swept

Femelle tournante à souder 45° BSP fond plat

Femmina 45° girevole a saldare BSP faccia piana

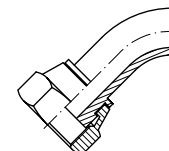

DN	THREAD ROSCA	Part n° Referencia	€
1/4"	1/4" BSP	Z104004	23,80
3/8"	3/8" BSP	Z104006	24,60
1/2"	1/2" BSP	Z104008	30,41
3/4"	3/4" BSP	Z104012	48,11
1"	1" BSP	Z104016	59,20
1"1/4	1"1/4 BSP	Z104020	87,74
1"1/2	1"1/2 BSP	Z104024	136,41
2"	2" BSP	Z104032	159,50

Racores soldables

Welding fittings
Embouts à souder
Raccordi a saldare

Hembra giratoria prensada soldable JIC 37° con guía

Welding JIC female 37° swept with guide

Femelle tournante JIC 37° à souder avec guide

Femmina girevole a saldare JIC 37°

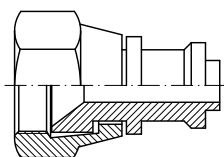

DN	THREAD ROSCA	Part nº Referencia	€
1/4"	7/16" 20h UNF	Z12830704	14,06
1/4"	1/2" 20h UNF	Z12830804	14,74
3/8"	9/16" 18h UNF	Z12830906	15,50
3/8"	3/4" 16h UNF	Z12831206	17,23
1/2"	3/4" 16h UNF	Z12831208	16,65
1/2"	7/8" 14h UNF	Z12831408	18,27
3/4"	1"1/16 12h UN	Z12831712	21,97
1"	1"5/16 12h UN	Z12832116	30,39
1"1/4	1"5/8 12h UN	Z12832620	57,47
1"1/2	1"7/8 12h UN	Z12833024	85,16

Macho soldable JIC 37° con guía

Welding fixed male JIC 37° with guide

Mâle à souder JIC 37° avec guide

Maschio JIC 37° a saldare

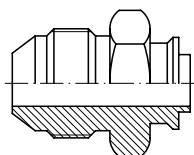

DN	THREAD ROSCA	Part nº Referencia	€
1/4"	7/16" 20h UNF	Z10360704	11,55
1/4"	1/2" 20h UNF	Z10360804	12,13
3/8"	9/16" 18h UNF	Z10360906	15,45
3/8"	3/4" 16h UNF	Z10361206	14,85
1/2"	3/4" 16h UNF	Z10361208	17,03
1/2"	7/8" 14h UNF	Z10361408	18,64
5/8"	7/8" 14h UNF	Z10361410	19,56
3/4"	1"1/16 12h UN	Z10361712	19,85
1"	1"5/16 12h UN	Z10362116	32,06
1"1/4	1"5/8 12h UN	Z10362620	50,70
1"1/4	1"7/8 12h UN	Z10363020	81,64

Hembra giratoria 90° prensada soldable JIC 37°

Welding 90° JIC Female 37° swept

Femelle tournante à souder 90° JIC 37°

Femmina 90° girevole a saldare JIC



DN	THREAD ROSCA	Part nº Referencia	€
1/4"	7/16" 20h UNF	Z10410704	23,94
1/4"	1/2" 20h UNF	Z10410804	23,49
3/8"	9/16" 18h UNF	Z10410906	23,83
1/2"	3/4" 16h UNF	Z10411208	27,35
1/2"	7/8" 14h UNF	Z10411408	26,42
3/4"	1"1/16 12h UN	Z10411712	52,54
1"	1"5/16 12h UN	Z10412116	60,17
1"1/4	1"5/8 12h UN	Z10412620	100,52
1"1/2	1"7/8 12h UN	Z10413024	170,41

Hembra giratoria 45° prensada soldable JIC 37°

Welding 45° JIC Female 37° swept

Femelle tournante à souder 45° JIC 37°

Femmina 45° girevole a saldare JIC

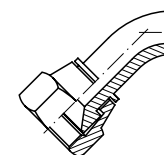

DN	THREAD ROSCA	Part nº Referencia	€
1/4"	7/16" 20h UNF	Z10420704	24,86
1/4"	1/2" 20h UNF	Z10420804	25,37
3/8"	9/16" 18h UNF	Z10420906	25,74
1/2"	3/4" 16h UNF	Z10421208	25,68
1/2"	7/8" 14h UNF	Z10421408	28,53
3/4"	1"1/16 12h UN	Z10421712	48,67
1"	1"5/16 12h UN	Z10422116	64,98
1"1/4	1"5/8 12h UN	Z10422620	108,56
1"1/2	1"7/8 12h UN	Z10423024	176,97

Racores soldables

Welding fittings
Embouts à souder
Raccordi a saldare

Hembra giratoria 90° soldable métrica

Weldable metrical swivel female 90°

Femelle tournante 90° métrique à souder

Femmina girevole 90° metrica a saldare

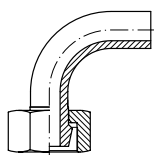

PIPE TUBO	THREAD ROSCA	Part nº Referencia	€
6	M12X1.5	Z10521206	21,83
8	M14X1.5	Z10521408	22,44
10	M16X1.5	Z10521610	30,53
12	M18X1.5	Z10521812	24,86
15	M22X1.5	Z10522215	30,67
18	M26X1.5	Z10522618	43,83
22	M30X2	Z10523022	54,14
28	M36X2	Z10523628	76,71
35	M45X2	Z10524535	134,44
42	M52X2	Z10525242	177,69
6	M14X1.5	Z10521406	22,84
8	M16X1.5	Z10521608	24,48
10	M18X1.5	Z10521810	23,68
12	M20X1.5	Z10522012	33,89
14	M22X1.5	Z10522214	28,63
16	M24X1.5	Z10522416	40,81
20	M30X2	Z10523020	49,72
25	M36X2	Z10523625	75,35
30	M42X2	Z10524230	110,82
38	M52X2	Z10525238	168,68

Tuercas Métricas

DIN nut

Écrou DIN

Dado DIN

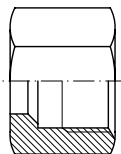

PIPE TUBO	THREAD ROSCA	Part nº Referencia	€
6	M12X1.5	Z10510612	2,09
6	M14X1.5	Z10510614	2,82
8	M14X1.5	Z10510814	2,59
8	M16X1.5	Z10510816	3,17
10	M16X1.5	Z10511016	2,97
10	M18X1.5	Z10511018	3,97
12	M18X1.5	Z10511218	3,58
12	M20X1.5	Z10511220	4,41
14	M22X1.5	Z10511422	7,17
15	M22X1.5	Z10511522	5,18
16	M24X1.5	Z10511624	7,97
18	M26X1.5	Z10511826	8,05
20	M30X2	Z10512030	12,14
22	M30X2	Z10512230	10,46
25	M36X2	Z10512536	28,66
28	M36X2	Z10512836	21,51
30	M42X2	Z10513042	34,78
35	M45X2	Z10513545	33,65
38	M52X2	Z10513852	54,57
42	M52X2	Z10514252	38,46

Hembra giratoria 45° soldable métrica

Weldable metrical swivel female 45°

Femelle tournante 45° métrique à souder

Femmina girevole 45° metrica a saldare

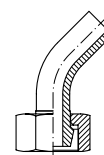

PIPE TUBO	THREAD ROSCA	Part nº Referencia	€
6	M12X1.5	Z10531206	23,58
8	M14X1.5	Z10531408	24,24
10	M16X1.5	Z10531610	26,37
12	M18X1.5	Z10531812	26,84
15	M22X1.5	Z10532215	33,11
18	M26X1.5	Z10532618	47,34
22	M30X2	Z10533022	58,47
28	M36X2	Z10533628	79,66
35	M45X2	Z10534535	145,20
42	M52X2	Z10535242	191,90
6	M14X1.5	Z10531406	24,67
8	M16X1.5	Z10531608	25,42
10	M18X1.5	Z10531810	25,57
12	M20X1.5	Z10532012	27,16
14	M22X1.5	Z10532214	30,92
16	M24X1.5	Z10532416	44,07
20	M30X2	Z10533020	53,70
25	M36X2	Z10533625	81,38
38	M52X2	Z10535238	182,18

Boquilla para soldar cono metal

Welding metal cone nipple

Raccord collet cône métallique à souder

Ogiva a saldare senza o'ring

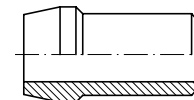

PIPE TUBO	SERIE	Part nº Referencia	€
10X1,5	L	Z CMORIL 10	8,61
15X2,5	L	Z CMORIL 15	14,51
18X2,5	L	Z CMORIL 18	15,38
22X2,5	L	Z CMORIL 22	19,38
28X3	L	Z CMORIL 28	22,81
35X4	L	Z CMORIL 35	37,77
42X3	L	Z CMORIL 42	59,93
6X2	L/S	Z CMORIS 6	7,06
8X2	L/S	Z CMORIS 8	9,12
10X2	L/S	Z CMORIS 10	8,61
12X2	L/S	Z CMORIS 12	10,24
14X3	S	Z CMORIS 14	11,05
16X3	S	Z CMORIS 16	14,81
20X3	S	Z CMORIS 20	16,97
25X4	S	Z CMORIS 25	26,49
30X5	S	Z CMORIS 30	28,99
38X5	S	Z CMORIS 38	42,50

En caso de querer la pieza con junta, ver pág. 105 / If you want the item with o'ring, please see page 105 / Si vous voulez la pièce avec le joint, voir page 105 / En caso de querer la pieza con junta, ver pág. 105

Racores soldables

Welding fittings
Embouts à souder
Raccordi a saldare

Espiga lisa métrica recta

Welding metric standpipe

Embout lisse métrique à souder

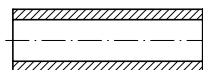

Estremità tubolare metrica diritta

Ø OUTER Ø EXT.	Ø INNER Ø INT.	Part n° Referencia	€
6	4	KZL0006	6,93
8	6	KZL0008	7,64
10	7	KZL0010	7,70
12	9	KZL0012	7,97
14	10	KZL0014	10,99
15	12	KZL0015	10,53
16	12	KZL0016	11,91
18	15	KZL0018	15,57
20	14	KZL0020	18,71
22	18	KZL0022	19,97

Espiga lisa métrica 90°

Welding metric standpipe 90°

Embout lisse métrique 90° à souder

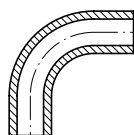

Estremità tubolare metrica a 90°

Ø OUTER Ø EXT.	Ø INNER Ø INT.	Part n° Referencia	€
6	4	KZC9006	6,16
8	4	KZC9008	8,76
10	6	KZC9010	9,20
12	8	KZC9012	11,42
14	10	KZC9014	13,54
15	11	KZC9015	14,69
16	11	KZC9016	17,03
18	14	KZC9018	19,70
20	12	KZC9020	23,21
22	18	KZC9022	27,04

Espiga lisa métrica 45°

Welding metric standpipe 45°

Embout lisse métrique 45° à souder

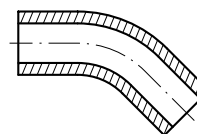

Estremità tubolare metrica a 45°

Ø OUTER Ø EXT.	Ø INNER Ø INT.	Part n° Referencia	€
6	4	KZC4506	6,16
8	4	KZC4508	8,76
10	6	KZC4510	9,20
12	8	KZC4512	11,42
14	10	KZC4514	13,54
15	11	KZC4515	14,69
16	11	KZC4516	17,03
18	14	KZC4518	19,70
20	12	KZC4520	23,21
22	18	KZC4522	27,04

Macho soldable Métrico

Welding DIN Male

Mâle à souder métrique

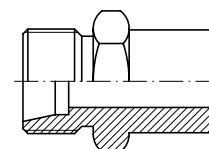

Maschio saldare DIN

PIPE TUBO	SERIE	Part n° Referencia	€
6	L	Z1050L06	7,38
8	L	Z1050L08	8,80
10	L	Z1050L10	9,43
12	L	Z1050L12	10,36
15	L	Z1050L15	16,34
18	L	Z1050L18	20,02
22	L	Z1050L22	30,66
28	L	Z1050L28	36,99
35	L	Z1050L35	60,07
42	L	Z1050L42	73,65
6	S	Z1050S06	9,19
8	S	Z1050S08	12,17
10	S	Z1050S10	14,04
12	S	Z1050S12	17,39
14	S	Z1050S14	21,55
16	S	Z1050S16	21,22
20	S	Z1050S20	25,60
25	S	Z1050S25	33,94
30	S	Z1050S30	48,28
38	S	Z1050S38	89,28

Racores soldables

Welding fittings
Embouts à souder
Raccordi a saldare

Tuerca cono ajuste BSP

BSP Nut for welding 60° cone nipple

Écrou gaz pour collet à souder

Dado BSP per ogiva a saldare cono 60°

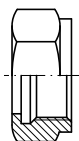

THREAD ROSCA	Part n° Referencia	€
1/4" BSP	Z127004	4,08
3/8" BSP	Z127006	5,85
1/2" BSP	Z127008	5,04
3/4" BSP	Z127012	7,49
1" BSP	Z127016	13,06
1"1/4 BSP	Z127020	28,21
1"1/2 BSP	Z127024	35,31
2" BSP	Z127032	53,59

Cono ajuste BSP 60°

Welding nipple BSP 60°

Collet à souder BSP cone 60°

Ogiva a saldare BSP

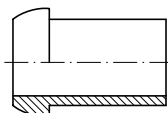

THREAD ROSCA	Part n° Referencia	€
1/4" BSP	Z127304	3,34
3/8" BSP	Z127306	3,60
1/2" BSP	Z127308	6,17
3/4" BSP	Z127312	7,42
1" BSP	Z127316	12,40
1"1/4 BSP	Z127320	19,35
1"1/2 BSP	Z127324	37,84
2" BSP	Z127332	41,40

Empalme liso soldable macho BSP 60°

Welding male BSP 60° union

Embout mâle lisse à souder BSP cône 60°

Mezzo Niples tondo maschio a saldare BSP 60°

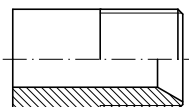

DN	THREAD ROSCA	Part n° Referencia	€
1/8"	1/8" BSP	Z129002	7,43
1/4"	1/4" BSP	Z129004	7,55
3/8"	3/8" BSP	Z129006	7,31
1/2"	1/2" BSP	Z129008	8,50
3/4"	3/4" BSP	Z129012	17,20
1"	1" BSP	Z129016	25,24
1"1/4	1"1/4 BSP	Z129020	32,50
1"1/2	1"1/2 BSP	Z129024	47,11
2"	2" BSP	Z129032	106,53

Tuercas BSP Microfundido AISI-316

Micro-casting BSP nuts AISI-316

Écrous BSP en acier moulé AISI-316

Dadi BSP microfusi AISI-316

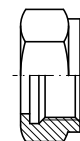

THREAD ROSCA	Part n° Referencia	€
2"1/2 BSP	Z127040	118,40
3" BSP	Z127048	154,48
4" BSP	Z127064	196,98

Cono ajuste BSP 60° con guía

Welding nipple with 60° cone for BSP nut with guide

Collet à souder BSP cone 60° avec guide

Ogiva a saldare cono 60° con guida per dado BSP

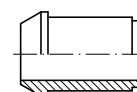

DN	THREAD ROSCA	Part n° Referencia	€
2"1/2	2"1/2 BSP	Z127840	96,37
3"	3" BSP	Z127848	121,91
4"	4" BSP	Z127864	171,30

Macho BSPT soldar microfundido AISI-316

Micro-casting BSPT welding male AISI-316

Mâle BSPT à souder en acier moulé AISI-316

Maschio BSPT a saldare microfuso AISI-316

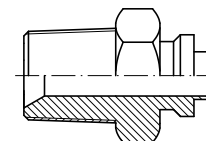

DN	THREAD ROSCA	Part n° Referencia	€
2"1/2	2"1/2 BSPT	ZM103240	126,81
3"	3" BSPT	ZM103248	155,48
4"	4" BSPT	ZM103264	200,13

Racores soldables

Welding fittings
Embouts à souder
Raccordi a saldare

Crimping fittings for hoses

Pipe fittings

Pipe fittings II

Adaptors

Welding fittings

Industrial fittings

Accessories

Control components

Flow measuring

Tr/Mc LOK

Unión 3 piezas hembra-soldar FIG.340HS microfundido

Union 3 fem. welding pieces fig.340hs micro-casting

Union 3 pcs fem. à souder fig.340hs inox acier moulé

Unione a 3 pezzi f.saldare fig.340hs inox microfusione

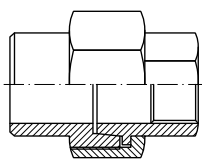

THREAD ROSCA	Part n° Referencia	€
1/4"	ZFIG34004HS	*
3/8"	ZFIG34006HS	*
1/2"	ZFIG34008HS	*
3/4"	ZFIG34012HS	*
1"	ZFIG34016HS	*
1" 1/4	ZFIG34020HS	*
1" 1/2	ZFIG34024HS	*
2"	ZFIG34032HS	*

*Ver precios en p.208 / *See prices p.208 / *Voir prix p.208 / *Vedere prezzi p.208

Unión 3 piezas macho-soldar FIG.341MS microfundido

Union 3 welding male pieces fig.341ms micro-casting

Union 3 pcs mâle à souder fig.341ms inox acier moulé

Unione a 3 pezzi m.saldare fig.341ms inox microfusione

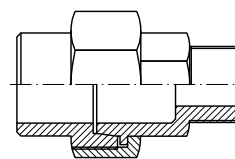

THREAD ROSCA	Part n° Referencia	€
1/4"	ZFIG34104MS	*
3/8"	ZFIG34106MS	*
1/2"	ZFIG34108MS	*
3/4"	ZFIG34112MS	*
1"	ZFIG34116MS	*
1" 1/4	ZFIG34120MS	*
1" 1/2	ZFIG34124MS	*
2"	ZFIG34132MS	*

*Ver precios en p.208 / *See prices p.208 / *Voir prix p.208 / *Vedere prezzi p.208

Unión 3 piezas soldar FIG.340S microfundido

Union 3 welding pieces fig. 340s micro-casting

Union 3 pièces à souder fig. 340s inox acier moulé

Unione a 3 pezzi a saldare fig.340s inox microfusione

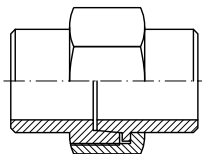

DN	Part n° Referencia	€
1/4"	ZFIG34004S	*
3/8"	ZFIG34006S	*
1/2"	ZFIG34008S	*
3/4"	ZFIG34012S	*
1"	ZFIG34016S	*
1" 1/4	ZFIG34020S	*
1" 1/2	ZFIG34024S	*
2"	ZFIG34032S	*

*Ver precios en p.208 / *See prices p.208 / *Voir prix p.208 / *Vedere prezzi p.208

Racores soldables

Welding fittings
Embouts à souder
Raccordi a saldare

Cono ajuste BSP asiento plano

Welding nipple BSP flat seat

Collet à souder BSP fond plat

Ogiva a saldare sede piana

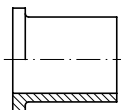

THREAD ROSCA	Ø OUTER Ø EXT.	Part nº Referencia	€
1/2 BSP	16	Z127408	5,92
1"1/4 BSP	33	Z127420	23,65
2" BSP	52.4	Z127432	46,80
1"1/4 BSP	33	Z127920	23,65

Hasta fin de existencias. Z127920 con guía. / Until end of stock. Z127920 with guide / Jusqu'à fin du stock. Z127920 avec guide. / Fino ad esaurimento scorta. Z127920 con guida

Cono ajuste BSP 60° con guía

Welding nipple with 60° cone for BSP nut with guide

Collet à souder BSP cone 60° avec guide

Ogiva a saldare cono 60° con guida per dado BSP

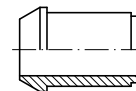

DN	THREAD ROSCA	Part nº Referencia	€
1"	1" BSP	Z127816	6,66
1"1/4	1"1/4 BSP	Z127820	17,70

Hasta fin de existencias. Ver H.G. SOLDAR BSP (Z1281...) / Until end of stock. See WELDABLE SWIVEL FEM.BSP (Z1281...) / Jusqu'à la fin du stock. Voir FEM.TOURN.À SOUDER BSP (Z1281...) / Fino ad esaurimento scorta. Vedere FEM. GIREV. BSP SALDARE (Z1281...)

Cono ajuste JIC 37° con guía

Welding nipple for JIC 37° with guide

Collet à souder femelle JIC cone 37° avec guide

Ogiva a saldare cono JIC 37° con guida



DN	THREAD ROSCA	Part nº Referencia	€
1/4"	7/16" 20h UNF	Z12770704	7,12
1/4"	1/2" 20h UNF	Z12770804	8,20
3/8"	9/16" 18h UNF	Z12770906	7,31
3/8"	3/4" 16h UNF	Z12771206	7,54
5/8"	7/8" 14h UNF	Z12771410	8,57
3/4"	1"1/16 12h UN	Z12771712	9,58
1"1/4	1"5/8 12h UN	Z12772620	25,61

Hasta fin de existencias / Until end of stock / Jusqu'à fin du stock / Fino ad esaurimento scorte

Tuercas JIC

JIC nut

Écrou JIC

Dado JIC

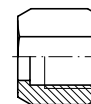

PIPE TUBO	THREAD ROSCA	Part nº Referencia	€	
6	1/4	7/16" 20h UNF	ZS11006	*
8	5/16	1/2" 20h UNF	ZS11008	*
10	3/8	9/16" 18h UNF	ZS11010	*
12	1/2	3/4" 16h UNF	ZS11012	*
14-15-16	5/8	7/8" 14h UNF	ZS11016	*
18-20	-	1"1/16 12h UN	ZS11020	*
-	3/4	1"1/16 12h UNF	ZS11020W	*
25	1	1"5/16 12h UN	ZS11025	*
30-32	1 1/4	1"5/8 12h UN	ZS11032	*
38	1 1/2	1"7/8 12h UN	ZS11038	*

*Ver precios en p.112 (R. JIC) / *See prices in p.112 (JIC Fittings) / *Prix à la page 112 (R. JIC) / *Vedere prezzi p.112 (R. JIC)

Bridas soldables

Welding flanges
Brides à souder
Flange a saldare

Brida fija soldable PN10/16 DIN 2633

Welding forged flange DIN 2633 PN 10/16

Bride fixe à souder DIN 2633 PN10/16

Flangia forgiata a saldare DIN 2633 PN 10/16

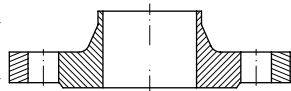

DN	Part nº Referencia	€
15-1/2"	ZBPN16263308	31,62
20-3/4"	ZBPN16263312	42,11
25-1"	ZBPN16263316	55,46
32-1"1/4	ZBPN16263320	74,92
40-1"1/2	ZBPN16263324	89,02
50-2"	ZBPN16263332	118,67
65-2"1/2	ZBPN16263340	135,66
80-3"	ZBPN16263348	138,42
100-4"	ZBPN16263364	211,02

Brida fija ANSI-ASA 150 LBS

Flange ANSI-ASA Welding Neck 150 LBS

Bride ANSI-ASA Welding Neck 150 LBS

Flangia ANSI-ASA a saldare 150 LBS

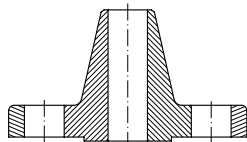

DN	Part nº Referencia	€
15-1/2"	ZBANSAWN15008	24,84
20-3/4"	ZBANSAWN15012	35,48
25-1"	ZBANSAWN15016	50,09
32-1"1/4	ZBANSAWN15020	61,79
40-1"1/2	ZBANSAWN15024	80,10
50-2"	ZBANSAWN15032	118,90
65-2"1/2	ZBANSAWN15040	188,76
80-3"	ZBANSAWN15048	233,14
100-4"	ZBANSAWN15064	313,63

Brida fija soldable PN40 DIN 2635

Welding forged flange DIN 2635 PN 40

Bride fixe à souder DIN 2635 PN 40

Flangia forgiata a saldare DIN 2635 PN 40

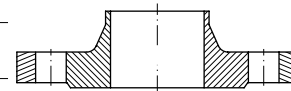

DN	Part nº Referencia	€
15-1/2"	ZBPN40263508	31,94
20-3/4"	ZBPN40263512	46,98
25-1"	ZBPN40263516	57,21
32-1"1/4	ZBPN40263520	80,10
40-1"1/2	ZBPN40263524	103,27
50-2"	ZBPN40263532	125,00
65-2"1/2	ZBPN40263540	165,78
80-3"	ZBPN40263548	202,47
100-4"	ZBPN40263564	277,90

Brida fija ANSI-ASA 300 LBS

FLANGE ANSI-ASA Welding Neck 300 LBS

Bride ANSI-ASA Welding Neck 300 LBS

Flangia ANSI-ASA a saldare 300 LBS

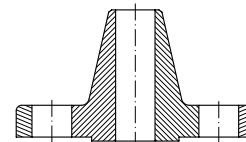

DN	Part nº Referencia	€
15-1/2"	ZBANSAWN30008	37,25
20-3/4"	ZBANSAWN30012	61,58
25-1"	ZBANSAWN30016	77,60
32-1"1/4	ZBANSAWN30020	94,22
40-1"1/2	ZBANSAWN30024	139,18
50-2"	ZBANSAWN30032	163,59
65-2"1/2	ZBANSAWN30040	236,92
80-3"	ZBANSAWN30048	313,23
100-4"	ZBANSAWN30064	508,85

Crimping fittings for hoses

Pipe fittings

Pipe fittings II

Adaptors

Welding fittings

Industrial fittings

Accessories

Control components

Flow measuring

Tr/Me LOK

Bridas soldables

Welding flanges
Brides à souder
Flange a saldare

Brida loca PN10 DIN 2642

Welding forged slip on flange DIN 2642 PN 10

Bride tournante à souder DIN 2642 PN 10

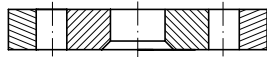

Flangia girevole a saldare DIN 2642 PN 10

DN	Part n° Referencia	€
15-1/2"	ZBPN10264208	26,34
20-3/4"	ZBPN10264212	32,22
25-1"	ZBPN10264216	55,92
32-1"1/4	ZBPN10264220	64,01
40-1"1/2	ZBPN10264224	71,26
50-2"	ZBPN10264232	84,01
65-2"1/2	ZBPN10264240	126,45
80-3"	ZBPN10264248	174,62
100-4"	ZBPN10264264	215,05

Aro para brida DIN 2642

Ring for flange DIN 2642

Collet épais pour bride DIN 2642

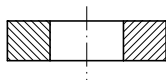

Anello per flangia DIN 2642

DN	Part n° Referencia	€
1/2"	ZABARO264208	10,89
3/4"	ZABARO264212	28,52
1"	ZABARO264216	36,77
1"1/4	ZABARO264220	45,84
1"1/2	ZABARO264224	56,72
2"	ZABARO264232	43,17
2"1/2	ZABARO264240	135,78
3"	ZABARO264248	213,21
4"	ZABARO264264	225,49

Tubo para soldar bridas ANSI-DIN

Tube for welding flanges ANSI-DIN

Tube à souder brides ANSI-DIN

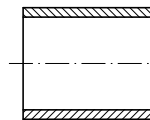

Tubo per flangia a saldare ANSI-DIN

DN	Part n° Referencia	€
3/8"	ZBTUBO06	6,03
1/2"	ZBTUBO08	9,74
3/4"	ZBTUBO12	8,31
1"	ZBTUBO16	9,17
1"1/4	ZBTUBO20	11,65
1"1/2	ZBTUBO24	14,56
2"	ZBTUBO32	19,02
2"1/2	ZBTUBO40	20,06
3"	ZBTUBO48	28,13
4"	ZBTUBO64	37,92

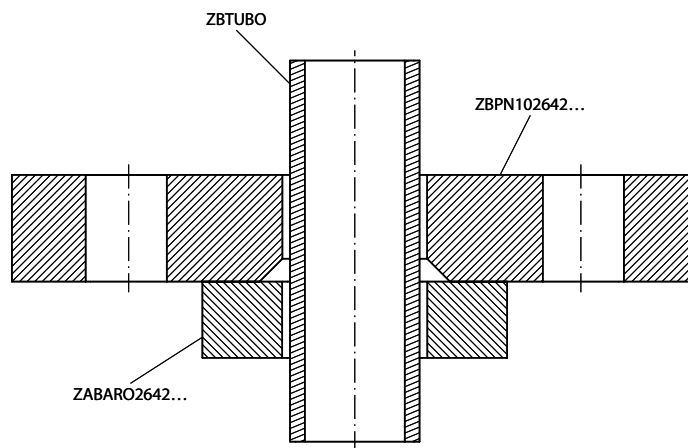

Bridas soldables

Welding flanges
Brides à souder
Flange a saldare

Brida plana PN40 DIN 2656

Welding forged flange DIN 2656 PN 40

Bride tournante à souder DIN 2656 PN 40

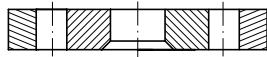

Flangia girevole a saldare DIN 2656 PN 40

DN	Part n° Referencia	€
15-1/2"	ZBPN40265608	30,28
20-3/4"	ZBPN40265612	36,49
25-1"	ZBPN40265616	44,46
32-1"1/4	ZBPN40265620	72,23
40-1"1/2	ZBPN40265624	81,71
50-2"	ZBPN40265632	106,80
65-2"1/2	ZBPN40265640	116,72
80-3"	ZBPN40265648	152,35
100-4"	ZBPN40265664	197,47

Aro para brida DIN 2656

Ring for flange DIN 2656

Collet épais pour bride DIN 2656

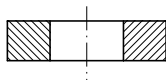

Anello per flangia DIN 2656

DN	Part n° Referencia	€
1/2"	ZABARO265608	15,09
3/4"	ZABARO265612	30,57
1"	ZABARO265616	39,38
1"1/4	ZABARO265620	47,02
1"1/2	ZABARO265624	61,91
2"	ZABARO265632	88,74
2"1/2	ZABARO265640	125,00
3"	ZABARO265648	158,61

Tubo para soldar bridas ANSI-DIN

Tube for welding flanges ANSI-DIN

Tube à souder brides ANSI-DIN

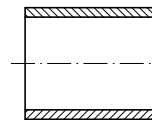

Tubo per flangia a saldare ANSI-DIN

DN	Part n° Referencia	€
3/8"	ZBTUBO06	6,03
1/2"	ZBTUBO08	9,74
3/4"	ZBTUBO12	8,31
1"	ZBTUBO16	9,17
1"1/4	ZBTUBO20	11,65
1"1/2	ZBTUBO24	14,56
2"	ZBTUBO32	19,02
2"1/2	ZBTUBO40	20,06
3"	ZBTUBO48	28,13
4"	ZBTUBO64	37,92

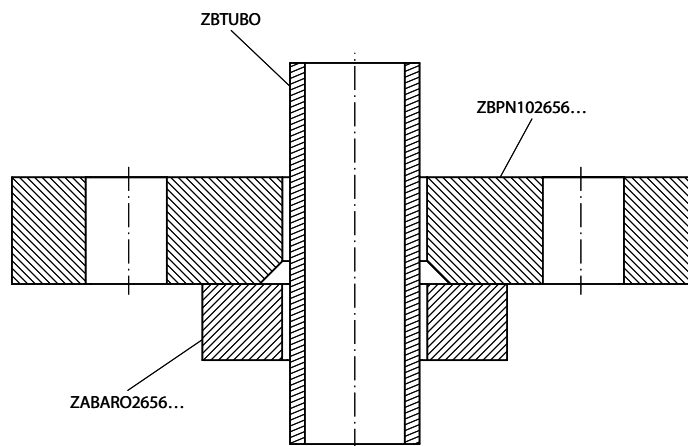

Bridas soldables

Welding flanges
Brides à souder
Flange a saldare

Brida plana ANSI-ASA 150 LBS

Swivel flange ANSI-ASA 150 LBS

Bride tournante ANSI-ASA 150 LBS

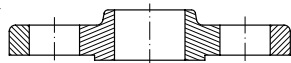

Flangia girevole ANSI-ASA 150 LBS

DN	Part n° Referencia	€
15-1/2"	ZBANSASO15008	18,29
20-3/4"	ZBANSASO15012	25,33
25-1"	ZBANSASO15016	34,90
32-1"1/4	ZBANSASO15020	43,48
40-1"1/2	ZBANSASO15024	58,56
50-2"	ZBANSASO15032	90,94
65-2"1/2	ZBANSASO15040	135,36
80-3"	ZBANSASO15048	173,16
100-4"	ZBANSASO15064	232,47

Brida plana ANSI-ASA 300 LBS

Swivel flange ANSI-ASA 300 LBS

Bride tournante ANSI-ASA 300 LBS



Flangia girevole ANSI-ASA 300 LBS

DN	Part n° Referencia	€
15-1/2"	ZBANSASO30008	29,03
20-3/4"	ZBANSASO30012	47,92
25-1"	ZBANSASO30016	61,08
32-1"1/4	ZBANSASO30020	71,87
40-1"1/2	ZBANSASO30024	109,98
50-2"	ZBANSASO30032	128,27
65-2"1/2	ZBANSASO30040	188,03
80-3"	ZBANSASO30048	420,66
100-4"	ZBANSASO30064	712,87

Aro para brida ANSI-ASA

Ring for flange ANSI-ASA

Collet épais pour brida ANSI-ASA

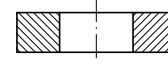

Anello per flangia ANSI-ASA

DN	Part n° Referencia	€
1/2"	ZABAROANSA08	6,44
3/4"	ZABAROANSA12	8,41
1"	ZABAROANSA16	10,09
1"1/4	ZABAROANSA20	14,62
1"1/2	ZABAROANSA24	19,67
2"	ZABAROANSA32	50,83
2"1/2	ZABAROANSA40	35,70
3"	ZABAROANSA48	56,23
4"	ZABAROANSA64	80,36

Tubo para soldar bridas ANSI-DIN

Tube for welding flanges ANSI-DIN

Tubo à souder brides ANSI-DIN

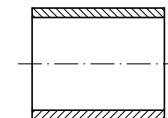

Tubo per flangia a saldare ANSI-DIN

DN	Part n° Referencia	€
3/8"	ZBTUBO06	6,03
1/2"	ZBTUBO08	9,74
3/4"	ZBTUBO12	8,31
1"	ZBTUBO16	9,17
1"1/4	ZBTUBO20	11,65
1"1/2	ZBTUBO24	14,56
2"	ZBTUBO32	19,02
2"1/2	ZBTUBO40	20,06
3"	ZBTUBO48	28,13
4"	ZBTUBO64	37,92

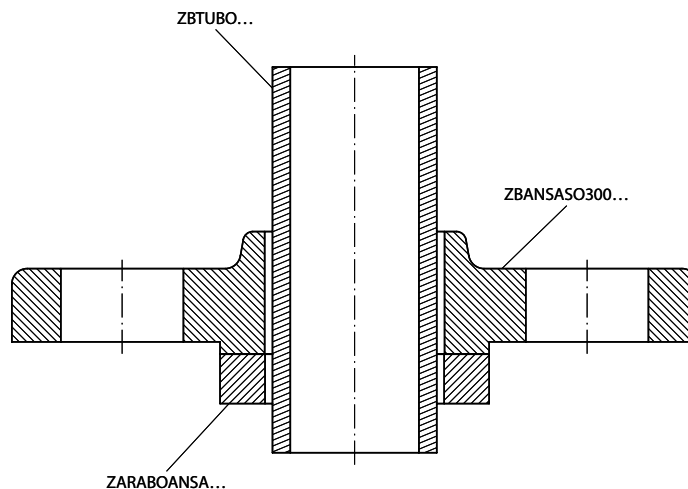
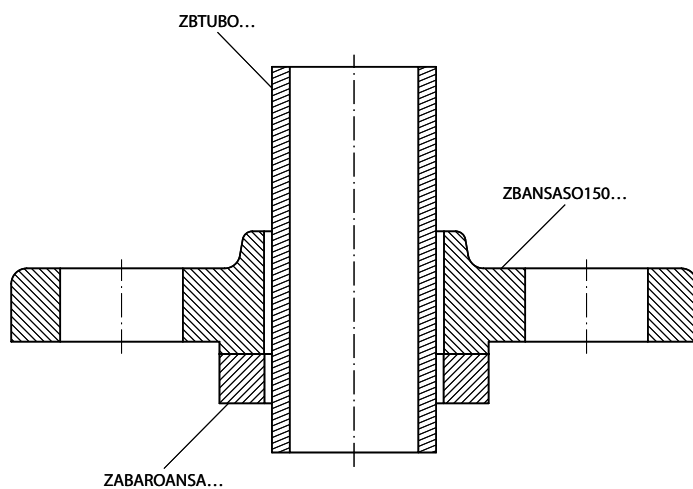

Racores industriales

Industrial fittings

Raccords industriels

Raccordi industriali

Racores industria alimentaria	191
<i>Food industry fittings</i>	
Raccords alimentaires	
<i>Raccordi alimentari</i>	
Serie Camlock DIN 2828	197
<i>DIN 2828 Camlock Fittings</i>	
Raccords Camlock DIN 2828	
<i>Camlock DIN 2828</i>	
Acoples GUILLEMIN NF E-29572	201
<i>GUILLEMIN NF E-29572 Fittings</i>	
Raccords GUILLEMIN NF E-29572	
<i>Raccordi GUILLEMIN NF E-29572</i>	
Acoples TW (Tankwagen) DIN 28450	203
<i>TW (Tankwagen) DIN 28450 Fittings</i>	
Raccords TW (Tankwagen) DIN 28450	
<i>Raccordi TW (Tankwagen) DIN 28450</i>	
Accesorios inox para racor industrial	204
<i>Stainless Steel accessories for industrial fitting</i>	
Accessoires acier inox pour raccord industriel	
<i>Accessori in acciaio inossidabile per raccordo industriale</i>	
Racores baja presión 150 LBS	205
<i>Screw low pressure fittings 150 LBS (Male BSPT / Female BSP)</i>	
Raccords basse pression 150 LBS (Mâle BSPT / Femelle BSP)	
<i>Raccordi bassa pressione 150 LBS (Maschio BSPT / Femmina BSP)</i>	

6

Racores industria alimentaria

Food industry fittings
Raccords alimentaires
Raccordi alimentari

■ Casquillos para prensar / Crimping ferrules / Jupes à sertir / Boccole a pressare

191

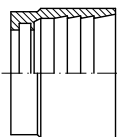

81042

■ Racores SMS / SMS Unions / Raccords SMS / Raccordi SMS

192

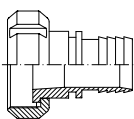

ZRA200

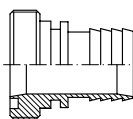

ZRA212

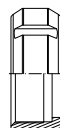

ZSMS H



ZSMS S



ZSMS M

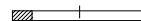

JSMS5



JSMS6

■ Racores Tri-Clamp / Clamp Unions / Raccords Tri-Clamp / Raccordi Tri-Clamp

193

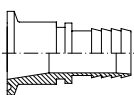

ZTC

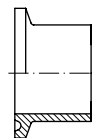

ZC

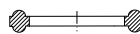

JCLAMPS

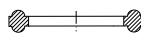

JCLAMPP

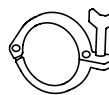

ZAC1P



ZPC

■ Racores DIN 11851 / DIN 11851 Unions / Raccords DIN 11851 / Raccordi DIN 11851

194

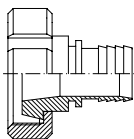

ZRA100

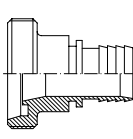

ZRA112



ZDIN H



ZDIN S



ZDIN M

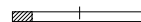

JDINS



JDINP

■ Racores Macon / Macon Unions / Raccords Macon / Raccordi Macon

195

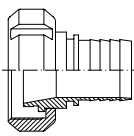

ZRA300

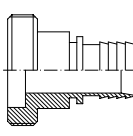

ZRA312



ZMAC H

■ Racores alimentarios para manguera PTFE Serie STD / Food industry fittings for PTFE hose STD Series / Raccords alimentaires pour tuyau PTFE Série STD / Raccordi alimentari per tubo PTFE Serie STD/

196

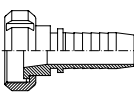

ZRA250

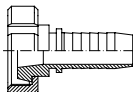

ZRA150

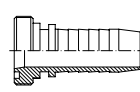

ZRA252

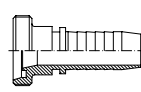

ZRA152

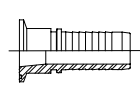

ZTCS

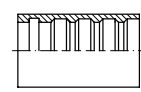

81040

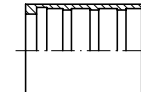

81041

Serie Camlock DIN 2828

DIN 2828 Camlock Fittings
Raccords Camlock DIN 2828
Camlock DIN 2828

Racores Camlock AISI 316 / Camlock Unions AISI 316 / Raccords Camlock AISI 316 / Raccordi Camlock AISI 316 | 197

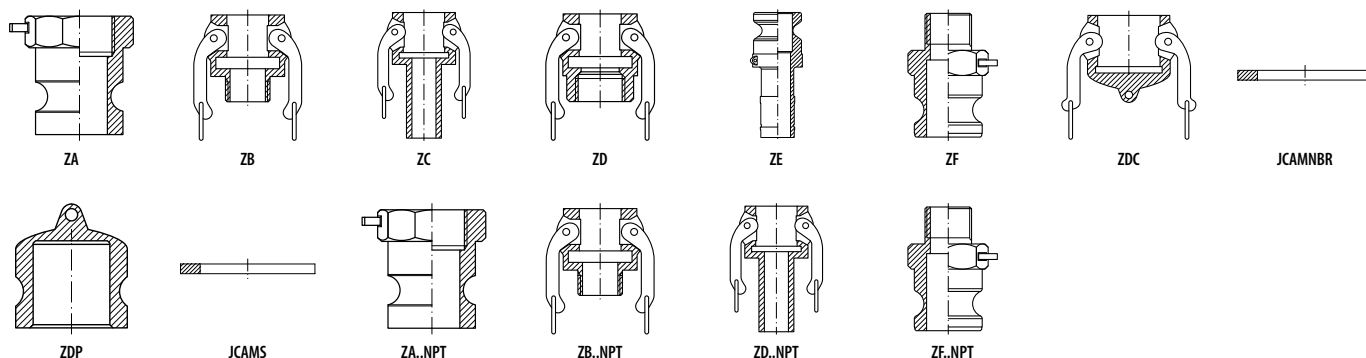

Racores Autolock AISI 316 / Autolock Unions AISI 316 / Raccords Autolock AISI 316 / Raccordi Autolock AISI 316 | 200



Acoples GUILLEMIN NF E-29572

GUILLEMIN NF E-29572 Fittings
Raccords GUILLEMIN NF E-29572
Raccordi GUILLEMIN NF E-29572

GUILLEMIN inox / GUILLEMIN Stainless Steel / GUILLEMIN acier inox / GUILLEMIN acciaio inossidabile | 201

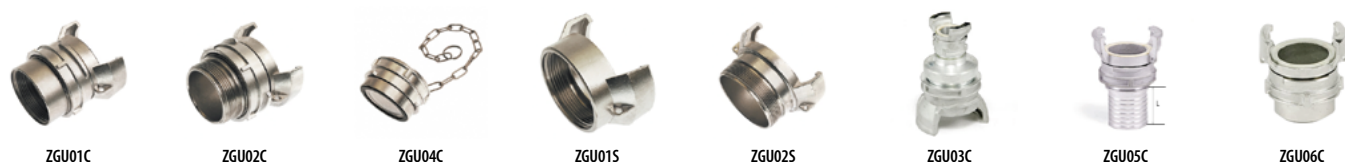

Acoples TW (Tankwagen) DIN 28450

TW (Tankwagen) DIN 28450 Fittings
Raccords TW (Tankwagen) DIN 28450
Raccordi TW (Tankwagen) DIN 28450

TW (Tankwagen) inox / TW Stainless Steel / TW acier inox / TW Acciaio Inossidabile | 203



Accesorios inox para racor industrial

Stainless Steel accessories for industrial fitting
Accessoires acier inox pour raccord industriel
Accessori in acciaio inossidabile per raccordo industriale

- Campana inox para racor industrial / Stainless Steel Crimping Ferrule for industrial fitting / Jupe pour raccord industriel acier inox / Boccola in acciaio inossidabile per raccordo industriale/ | 204



ZCA

- Abrazadera inox para racor industrial / Stainless Steel clamp for industrial fitting / Collier pour raccord industriel acier inox / Collare in acciaio inossidabile per raccordo industriale | 204



ZAB01



ZAB02

Racores baja presión 150 LBS

Screw low pressure fittings 150 LBS (Male BSPT / Female BSP)
Raccords basse pression 150 LBS (Mâle BSPT / Femelle BSP)
Raccordi bassa pressione 150 LBS (Maschio BSPT / Femmina BSP)

- 150 LBS Microfundido / Screwed fittings low pressure 150 LBS / Adapteurs basse pression 150 LBS / Raccordi bassa pressione | 205

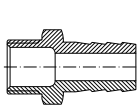

ZFIG399

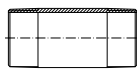

ZFIG150

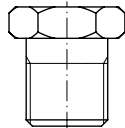

ZFIG290

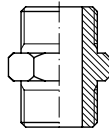

ZFIG280

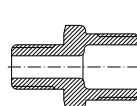

ZFIG245

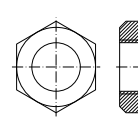

ZFIG312

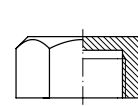

ZFIG300

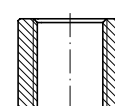

ZFIG270

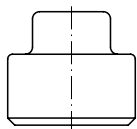

ZFIG291

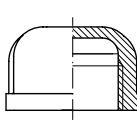

ZFIG301

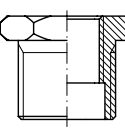

ZFIG241

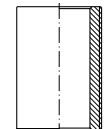

ZFIG531

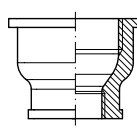

ZFIG240

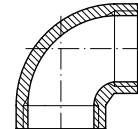

ZFIG090

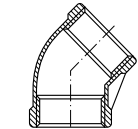

ZFIG120

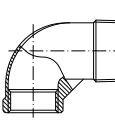

ZFIG092

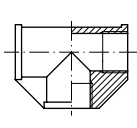

ZFIG130

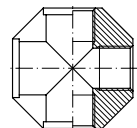

ZFIG180

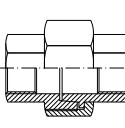

ZFIG340

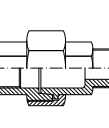

ZFIG341

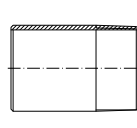

ZFIG149

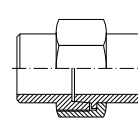

ZFIG340...HS

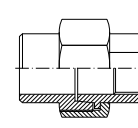

ZFIG340...S

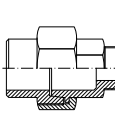

ZFIG341...MS

- 150 LBS Soldables / Welding fittings low pressure 150 LBS / Raccords à souder basse pression 150 LBS / Raccordi bassa pressione per saldare 150 LBS | 209

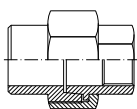

ZFIG340...HS

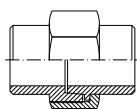

ZFIG340...S

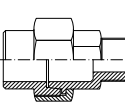

ZFIG341...MS

- 150 LBS Válvulas / 150 LBS fittings Valves / Raccords Vannes 150 LBS / Raccordi Valvole 150LBS | 209

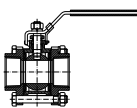

BP2V3P

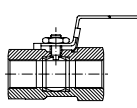

BP2V

Racores industria alimentaria

Food industry fittings
Raccords alimentaires
Raccordi alimentari

Casquillos para mangueras alimentarias

Food industry hoses ferrules

Jupes à sertir tuyaux alimentaires

Boccola a pressare per tubi alimentari

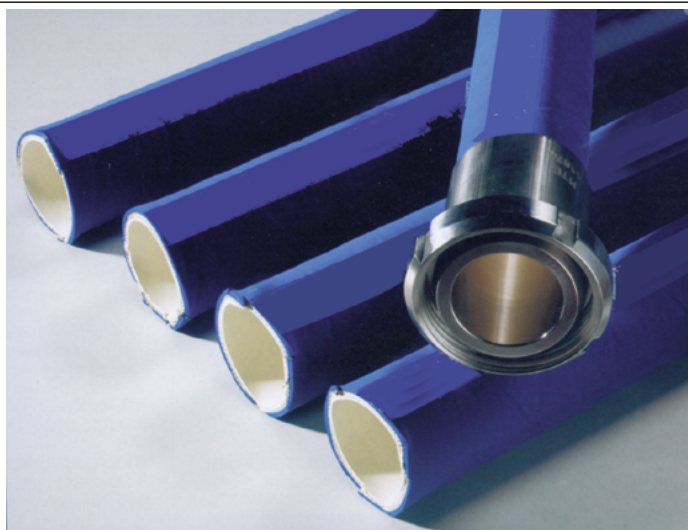
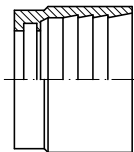

DN	Ø HOSE Ø MANGUERA	Part nº Referencia	€
13-1/2"	23	810421324	15,34
19-3/4"	32	810421933	18,76
25-1"	39	810422540	19,55
32-1"1/4	48	810423248	34,65
38-1"1/2	52	810423852	44,19
38-1"1/2	56	810423857	53,59
40-1"1/2	54	810424055	47,87
40-1"1/2	60	810424061	78,65
50-2"	63	810425064	59,35
50-2"	68	810425069	70,27
50-2"	73	810425073	77,40
65-2"1/2	79	810426580	81,58
65-2"1/2	93	810426593	151,16
70-3"	89	810427090	177,02
75-3"	94	810427595	133,04
75-3"	106	8104275107	185,95
100-4"	122	81042100123	201,27
100-4"	134	81042100135	334,73



MANGUERAS ALIMENTARIAS | FOOD INDUSTRY HOSES



INDUG TrΔle 25X37 DRINKS (máx.40%) EPDM S&D

INDUG TrΔle 25X38 MILK & DAIRY NR S&D FDA

INDUG TrΔle FOOD S&D HOSE FDA WP 10 bar

Mangueras aptas para productos alimentarios de aspiración e impulsión:
Leche, vino, aceites, alimentos grasos, bebidas alcohol (máx. 40%), etc.

*Professional hoses application in the food industry for suction and discharge:
Milk, wine, oils, fatty foods, alcohol drinks (max 40%), etc.*

Consulta en nuestra ficha técnica datos y marcajes. | Check our technical sheet for data and markings options.
Ver precios en Catálogo Conducciones. | See prices in Connectors Catalogue.

Racores industria alimentaria

Food industry fittings
Raccords alimentaires
Raccordi alimentari

Hembras giratorias SMS

Swivel female SMS

Raccord femelle tournante SMS

Femmina girevole SMS

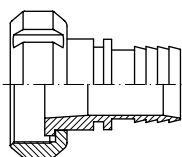

DN	THREAD ROSCA	Part n° Referencia	€
25	40x1/6	ZRA2004025	37,73
32	48x1/6	ZRA2004832	55,73
38	60x1/6	ZRA2006038	67,20
40	60x1/6	ZRA2006040	71,73
50	70x1/6	ZRA2007050	95,18
63	85x1/6"	ZRA2008563	161,78
65	85x1/6	ZRA2008565	150,40
70	98x1/6	ZRA2009870	262,51
75	98x1/6	ZRA2009875	222,28
80	98x1/6	ZRA2009880	288,58
100	125x1/4	ZRA200125100	381,37
100	132x1/6	ZRA200132100	430,83

Machos fijos SMS

Fixed male SMS

Raccord mâle SMS

Maschio fisso SMS

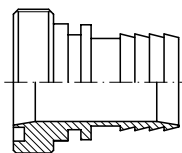

DN	THREAD ROSCA	Part n° Referencia	€
25	40x1/6	ZRA2124025	43,07
32	48x1/6	ZRA2124832	61,23
38	60x1/6	ZRA2126038	74,47
40	60x1/6	ZRA2126040	73,35
50	70x1/6	ZRA2127050	102,48
63	85x1/6	ZRA2128563	140,68
65	85x1/6	ZRA2128565	140,68
70	98x1/6	ZRA2129870	305,85
75	98x1/6	ZRA2129875	311,97
80	98x1/6	ZRA2129880	305,94
100	125x1/4	ZRA212125100	408,87
100	132x1/6	ZRA212132100	418,88

Tuercas SMS

Nuts SMS

Écrou SMS

Dadi SMS



DN	THREAD ROSCA	Part n° Referencia	€
25	40x1/6	ZSMS H 25	11,03
32	48x1/6	ZSMS H 32	15,13
38	60x1/6	ZSMS H 38	20,56
51	70x1/6	ZSMS H 51	22,95
63	85x1/6	ZSMS H 63	28,02
76	98x1/6	ZSMS H 76	42,83
104	125x1/4	ZSMS H 104	52,98
104	132x1/6	ZSMS H 105	80,15

Conos soldables SMS

Liner to weld SMS

Douilles à souder SMS

Sede a saldare per femmina SMS

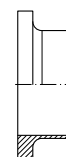

DN	Part n° Referencia	€
25	ZSMS S 25	3,72
32	ZSMS S 32	7,13
38	ZSMS S 38	6,65
51	ZSMS S 51	8,30
63	ZSMS S 63	11,44
76	ZSMS S 76	16,02
104	ZSMS S 104	20,52

Machos soldables SMS

Weld male SMS

Nez à souder SMS

Maschio a saldare SMS

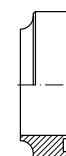

DN	THREAD ROSCA	Part n° Referencia	€
25	40x1/6	ZSMS M 25	6,36
32	48x1/6	ZSMS M 32	12,08
38	60x1/6	ZSMS M 38	14,80
51	70x1/6	ZSMS M 51	17,38
63	85x1/6	ZSMS M 63	26,03
76	98x1/6	ZSMS M 76	31,46
104	125x1/4	ZSMS M 104	40,56

Junta SMS silicona

Silicone joint for SMS

Joint silicone pour SMS

Guarnizione in silicone per SMS

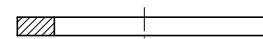

DN	Part n° Referencia	€
25	JSMSS 25	2,24
32	JSMSS 32	2,77
38	JSMSS 38	3,15
50/51	JSMSS 51	3,46
63/65	JSMSS 63	4,62
75/76	JSMSS 76	5,11
100/104	JSMSS 104	5,92

Juntas SMS PTFE

PTFE Joint for SMS

Joint PTFE pour SMS

Guarnizione in PTFE per SMS

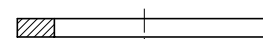

DN	Part n° Referencia	€
25	JSMSP 25	5,54
32	JSMSP 32	6,70
38	JSMSP 38	8,54
51	JSMSP 51	9,45
63	JSMSP 63	13,23
76	JSMSP 76	17,01

Racores industria alimentaria

Food industry fittings
Raccords alimentaires
Raccordi alimentari

Crimping fittings for hoses

Pipe fittings

Pipe fittings II

Adaptors

Welding fittings

Industrial fittings

Accessories

Control components

Flow measuring

Tri/Le-LOK

Tri-Clamp ISO 2852

Tri-Clamp ISO 2852

Raccord Tri-Clamp ISO 2852

Tri-Clamp ISO 2852 per tubo flessibile

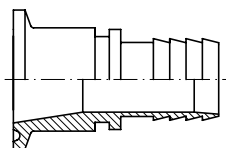

DN	Ø	Part n° Referencia	€
12	25	ZTC2512	23,13
12	34	ZTC3412	35,25
19	34	ZTC3419	29,99
19	50	ZTC5019	39,99
25	50	ZTC5025	37,55
32	50	ZTC5032	40,65
38	50	ZTC5038	47,06
40	50	ZTC5040	51,34
38	64	ZTC6438	80,10
40	64	ZTC6440	63,41
50	64	ZTC6450	74,54
50	77	ZTC7750	110,65
65	91	ZTC9165	168,30

Tri-Clamp para soldar en tubo

Welding Tri-Clamp for pipe

Raccord Tri-Clamp à souder pour tube

Tri-Clamp a saldare per tubo rigido

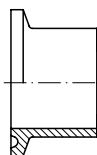

DN	Ø	Part n° Referencia	€
12	25	ZC25-12	6,73
12	34	ZC34-12	8,27
18	34	ZC34-18	7,78
18	50.5	ZC50-18	8,34
25	50.5	ZC50-25	7,63
33.7	50.5	ZC50-33.7	9,50
38	50.5	ZC50-38	9,11
38	64	ZC64-38	14,02
51	64	ZC64-51	11,91
65	91	ZC91-65	15,56

Juntas para Clamp Silicona

Joint for silicone clamp

Joint pour clamp silicone

Guarnizione per clamp Silicone

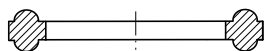

Ø	Part n° Referencia	€
25	JCLAMPS 25	4,05
34	JCLAMPS 34	4,05
50	JCLAMPS 50	4,10
64	JCLAMPS 64	5,55
77	JCLAMPS 77	7,66
91	JCLAMPS 91	10,78

Juntas para Clamp PTFE

Joint for PTFE clamp

Joint pour clamp PTFE

Guarnizione per clamp PTFE

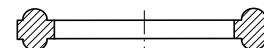

Ø	Part n° Referencia	€
25	JCLAMPP 25	*
34	JCLAMPP 34	*
50	JCLAMPP 50	*
64	JCLAMPP 64	*
77	JCLAMPP 77	*
91	JCLAMPP 91	*

Abrazaderas Tri-clamp con 1 pin

Tri-Clamp with 1 pin

Collier Tri-Clamp avec 1 pin

Collare Tri-Clamp con 1 pin



Ø	Part n° Referencia	€
25	ZAC1P25	14,27
34	ZAC1P34	14,27
50	ZAC1P50	16,89
64	ZAC1P64	20,34
77	ZAC1P77	24,38
91	ZAC1P91	27,10

Tri-Clamp Tapa

Tri-Clamp cover

Tri-Clamp Couvercle

Tri-Clamp copertura

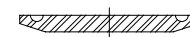

Ø	Part n° Referencia	€
25	ZPC25	4,39
34	ZPC34	4,96
50.5	ZPC50	6,42
64	ZPC64	8,26
77.5	ZPC77	10,99
91	ZPC91	13,22

Racores industria alimentaria

Food industry fittings
Raccords alimentaires
Raccordi alimentari

Hembras giratorias DIN 11851

Swivel female DIN 11851

Raccord femelle tournante DIN 11851

Femmina girevole DIN 11851

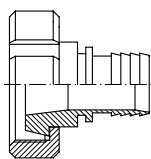

DN	THREAD ROSCA	Part n° Referencia	€
20	44x1/6	ZRA1004420	43,13
25	52x1/6	ZRA1005225	46,60
32	58x1/6	ZRA1005832	56,88
38	65x1/6	ZRA1006538	65,48
40	65x1/6	ZRA1006540	70,68
50	78x1/6	ZRA1007850	99,18
63	95x1/6	ZRA1009563	175,41
65	95x1/6	ZRA1009565	162,61
75	110x1/4	ZRA10011075	254,77
80	110x1/4	ZRA10011080	277,71
100	130x1/4	ZRA100130100	353,68

Machos fijos DIN 11851

Fixed male DIN 11851

Raccord mâle DIN 11851

Maschio fisso DIN 11851

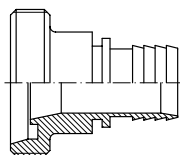

DN	THREAD ROSCA	Part n° Referencia	€
25	52x1/6	ZRA1125225	70,16
32	58x1/6	ZRA1125832	83,14
38	65x1/6	ZRA1126538	114,05
40	65x1/6	ZRA1126540	112,63
50	78x1/6	ZRA1127850	115,67
63	95x1/6	ZRA1129563	189,58
65	95x1/6	ZRA1129565	197,99
75	110x1/4	ZRA11211075	278,21
80	110x1/4	ZRA11211080	280,38
100	130x1/4	ZRA112130100	520,15

Tuercas DIN 11851

Nuts DIN 11851

Écrous DIN 11851

Dado DIN 11851



DN	THREAD ROSCA	Part n° Referencia	€
16	34x1/8	ZDIN H 16	8,58
20	44x1/6	ZDIN H 20	11,68
25	52x1/6	ZDIN H 25	14,08
32	58x1/6	ZDIN H 32	16,23
40	65x1/6	ZDIN H 40	18,80
50	78x1/6	ZDIN H 50	23,75
65	95x1/6	ZDIN H 65	39,38
80	110x1/4	ZDIN H 80	53,41
100	130x1/4	ZDIN H 100	73,79

Conos soldables DIN 11851

Liner to weld DIN 11851

Douilles à souder DIN 11851

Ogiva a saldare per dado DIN 11851

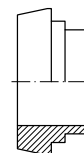

DN	Part n° Referencia	€
16	ZDIN S 16	3,21
20	ZDIN S 20	4,68
25	ZDIN S 25	6,86
32	ZDIN S 32	8,73
40	ZDIN S 40	10,05
50	ZDIN S 50	18,34
65	ZDIN S 65	22,66
75/80	ZDIN S 80	30,82
100	ZDIN S 100	49,26

Machos soldables DIN 11851

Weld male DIN 11851

Nez à souder DIN 11851

Maschio a saldare DIN 11851

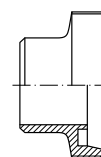

DN	THREAD ROSCA	Part n° Referencia	€
16	34x1/8	ZDIN M 16	5,15
20	44x1/6	ZDIN M 20	9,94
25	52x1/6	ZDIN M 25	9,94
32	58x1/6	ZDIN M 32	13,17
40	65x1/6	ZDIN M 40	16,47
50	78x1/6	ZDIN M 50	24,20
65	95x1/6	ZDIN M 65	33,25
75/80	110x1/4	ZDIN M 80	49,48
100	130x1/4	ZDIN M 100	65,06

Racores industria alimentaria

Food industry fittings
Raccords alimentaires
Raccordi alimentari

Juntas DIN 11851 silicona

Silicone joint for DIN 11851

Joint silicone pour DIN 11851

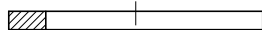

Guarnizione in silicone per DIN 11851

DN	Part n° Referencia	€
20	JDINS 20	1,23
25	JDINS 25	1,92
32	JDINS 32	2,24
38/40	JDINS 40	2,38
50	JDINS 50	3,08
65	JDINS 65	4,00
80	JDINS 80	5,16
100	JDINS 100	6,59

Juntas DIN 11851 PTFE

PTFE Joint for DIN 11851

Joint PTFE pour DIN 11851

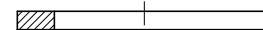

Guarnizione in PTFE per DIN 11851

DN	Part n° Referencia	€
20	JDINP 20	8,54
25	JDINP 25	9,16
32	JDINP 32	9,62
40	JDINP 40	10,46
50	JDINP 50	11,78
65	JDINP 65	13,01
80	JDINP 80	13,91
80	JDINP 100	48,50

Hembras giratorias Macon

Swivel female Macon

Raccord femelle tournante Macon

Femmina girevole Macon

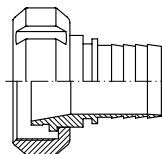

DN	THREAD ROSCA	Part n° Referencia	€
38	55X3	ZRA3005538	*
40	55X3	ZRA3005540	*
50	67X3	ZRA3006750	*
65	79X3.5	ZRA3007965	*
65	90X3.5	ZRA3009065	*
70	90X3.5	ZRA3009070	*
80	90X3.5	ZRA3009080	*
80	102x4	ZRA30010280	*
100	125X4	ZRA300125100	*

Machos fijos Macon

Male fixe Macon

Raccord mâle fixe Macon

Maschio fisso Macon

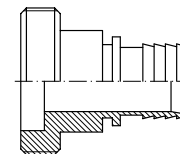

DN	THREAD ROSCA	Part n° Referencia	€
38	55X3	ZRA3125538	*
40	55X3	ZRA3125540	*
50	67X3	ZRA3126750	*
65	79X3.5	ZRA3127965	*
65	90X3.5	ZRA3129065	*
70	90X3.5	ZRA3129070	*
75	90X3.5	ZRA3129080	*
80	102X4	ZRA31210280	*
100	125X4	ZRA312125100	*

Tuercas Macon

Macon nuts

Écrous à crans Macon

Dadi Macon



DN	THREAD ROSCA	Part n° Referencia	€
40	55X3	ZMAC H 40	19,25
50	67X3	ZMAC H 50	22,24
60	79X3.5	ZMAC H 60	31,99
70	90X3.5	ZMAC H 70	36,21
80	102X4	ZMAC H 80	40,01
100	125X4	ZMAC H 100	47,16

Racores industria alimentaria para tubo PTFE

Food industry fittings for PTFE hose

Raccords alimentaires pour PTFE

Raccordi alimentari per tubo PTFE

Hembras giratorias prensar SMS para PTFE Serie STD

Swivel female SMS for PTFE STD Series

Femelle tournante SMS pour PTFE Série STD

Femmina girevole SMS per tubo PTFE Serie STD

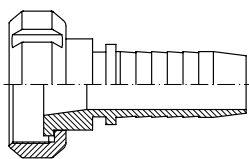

DN	THREAD ROSCA	Part n° Referencia	€
1"	40x1/6"	ZRA2504016	59,19
1" 1/4	48x1/6"	ZRA2504820	64,47
1" 1/2	60x1/6"	ZRA2506024	94,09
2"	70x1/6"	ZRA2507032	120,96
2" 1/2	85x1/6"	ZRA2508540	183,61

Hembras giratorias DIN 11851 para PTFE Serie STD

Swivel female DIN 11851 for PTFE hose STD Series

Raccord femelle tournante DIN 11851 pour PTFE Série STD

Femmina girevole DIN 11851 per tubo PTFE Serie STD

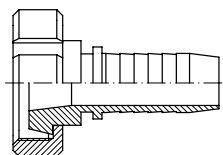

DN	THREAD ROSCA	Part n° Referencia	€
1"	52x1/6"	ZRA1505216	78,25
1" 1/4	58x1/6"	ZRA1505820	90,21
1" 1/2	65x1/6"	ZRA1506524	88,09
2"	78x1/6"	ZRA1507832	128,34
2" 1/2	95x1/6"	ZRA1509540	203,30

Machos SMS para PTFE Serie STD

Fixed male SMS for PTFE hose STD Series

Raccord mâle SMS pour PTFE Série STD

Maschio SMS per tubo PTFE Serie STD

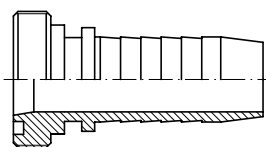

DN	THREAD ROSCA	Part n° Referencia	€
1"	40x1/6"	ZRA2524016	51,42
1" 1/4	48x1/6"	ZRA2524820	67,35
1" 1/2	60x1/6"	ZRA2526024	84,60
2"	70x1/6"	ZRA2527032	126,13
2" 1/2	85x1/6"	ZRA2528540	175,37

Machos DIN 11851 para PTFE Serie STD

Fixed male DIN 11851 for PTFE hose STD Series

Raccord mâle DIN 11851 pour PTFE Série STD

Maschio DIN 11851 per tubo PTFE Serie STD

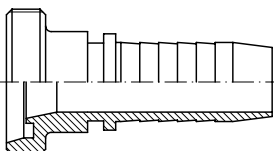

DN	THREAD ROSCA	Part n° Referencia	€
1"	52x1/6"	ZRA1525216	82,73
1" 1/4	58x1/6"	ZRA1525820	87,93
1" 1/2	65x1/6"	ZRA1526524	107,59
2"	78x1/6"	ZRA1527832	161,79
2" 1/2	95x1/6"	ZRA1529540	261,04

Racores Tri-Clamp

Tri-Clamp Fittings

Raccords Tri-Clamp

Raccordi Tri-Clamp

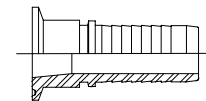

DN	Ø	Part n° Referencia	€
3/8"	34	ZTCS3406	41,47
3/4"	50	ZTCS5012	47,91
1"	50	ZTCS5016	50,56
1" 1/4	50	ZTCS5020	61,37
1" 1/2	64	ZTCS6424	91,19
2"	64	ZTCS6432	109,18
2"	77	ZTCS7732	135,20

Casquillos PTFE liso

Ferrules for smooth PTFE

Jupes PTFE lisse

Boccole pressare per PTFE liscio

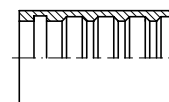

DN	Part n° Referencia	€
1/8"	810400100	*
3/16"	810400300	*
1/4"	810400400	*
5/16"	810400500	*
3/8"	810400600	*
1/2"	810400800	*
5/8"	810401000	*
3/4"	810401200	*
1"	810401600	*

*Ver precios en p.22 / *See prices p.22 / *Voir prix p.22 / *Vedere prezzi p.22

Casquillos PTFE corrugado

Ferrules for convoluted PTFE

Jupes PTFE convoluté

Boccola pressare per PTFE corrugato

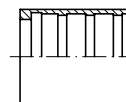

DN	Part n° Referencia	€
1/4"	810410400	*
5/16"	810410500	*
3/8"	810410600	*
1/2"	810410800	*
5/8"	810411000	*
3/4"	810411201	*
1"	810411600	*
1" 1/4	810412000	*
1" 1/2	810412400	*
2"	810413200	*
2" 1/2	810414000	*

*Ver precios en p.22 / *See prices p.22 / *Voir prix p.22 / *Vedere prezzi p.22

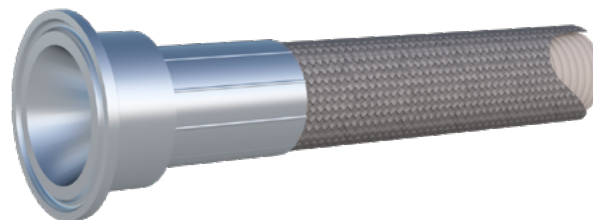
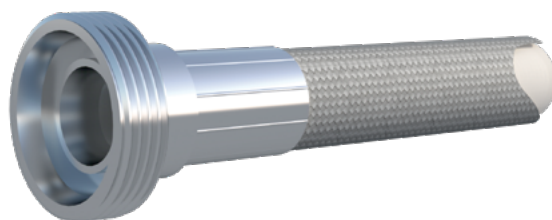

Serie Camlock DIN 2828

DIN 2828 Camlock Fittings
Raccords Camlock DIN 2828
Camlock DIN 2828

Crimping fittings for hoses

Pipe fittings

Pipe fittings II

Adaptors

Welding fittings

Industrial fittings

Accessories

Control components

Flow measuring

Tri/Le LOK

Camlock macho - rosca hembra BSP Tipo A

Male Camlock coupling, female BSP threaded
Type A

Adapteur mâle Camlock- filetage femelle BSP
Type A

Adattatore Camlock maschio-filettatura femmina
BSP Tipo A

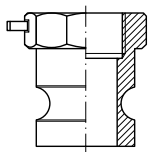

DN	THREAD ROSCA	Part n° Referencia	€
12	1/2"	ZA012	6,28
20	1/2"	ZA015	6,28
20	3/4"	ZA020	8,61
25	1"	ZA025	11,34
32	1"1/4	ZA032	15,88
40	1"1/2	ZA040	21,65
50	2"	ZA050	25,79
65	2"1/2	ZA065	41,04
80	3"	ZA080	52,25
100	4"	ZA100	72,62

Camlock hembra - rosca hembra BSP Tipo D

Female Camlock coupling, female BSP threaded
Type D

Adapteur Camlock femelle BSP Type D

Adattatore Camlock femmina BSP Tipo D

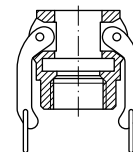

DN	THREAD ROSCA	Part n° Referencia	€
12	1/2"	ZD012	12,71
20	1/2"	ZD015	14,29
20	3/4"	ZD020	14,37
25	1"	ZD025	19,76
32	1"1/4	ZD032	30,06
40	1"1/2	ZD040	29,61
50	2"	ZD050	41,36
65	2"1/2	ZD065	51,66
80	3"	ZD080	66,96
100	4"	ZD100	105,75

Camlock hembra - rosca macho BSPT Tipo B

Female Camlock coupling, female BSPT threaded
Type B

Adapteur Camlock femelle - filetage mâle BSPT
Type B

Adattatore Camlock femmina-filettatura maschio
BSPT Tipo B

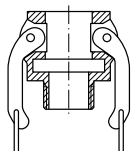

DN	THREAD ROSCA	Part n° Referencia	€
12	1/2"	ZB012	14,74
20	1/2"	ZB015	13,68
20	3/4"	ZB020	14,52
25	1"	ZB025	19,50
32	1"1/4	ZB032	28,14
40	1"1/2	ZB040	29,25
50	2"	ZB050	39,51
65	2"1/2	ZB065	52,16
80	3"	ZB080	73,67
100	4"	ZB100	103,89

Camlock macho - para manguera Tipo E

Male Camlock coupling, with serrated hose shank
Type E

Coupleur Camlock mâle Type E

Adattatore Camlock con inserto per Tipo E

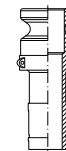

DN	Part n° Referencia	€
1/2"	ZE012	6,46
1/2"	ZE015	6,72
3/4"	ZE020	8,81
1"	ZE025	13,20
1"1/4	ZE032	17,73
1"1/2	ZE040	25,14
2"	ZE050	32,37
2"1/2	ZE065	44,82
3"	ZE080	81,47
4"	ZE100	105,86

Camlock hembra - para manguera Tipo C

Female Camlock coupling with serrated hose
shank Type C

Coupleur Camlock femelle - pour tuyau Type C

Adattatore Camlock con inserto per tubo Tipo C

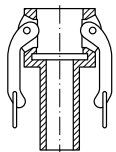

DN	Part n° Referencia	€
1/2"	ZC012	12,14
1/2"	ZC015	13,98
3/4"	ZC020	15,17
1"	ZC025	19,76
1"1/4	ZC032	27,25
1"1/2	ZC040	30,11
2"	ZC050	38,23
2"1/2	ZC065	55,13
3"	ZC080	88,67
4"	ZC100	113,33

Camlock macho - rosca macho BSPT Tipo F

Male Camlock coupling, male BSPT threaded
Type F

Adapteur Camlock mâle BSPT Type F

Adattatore Camlock maschio BSPT Tipo F

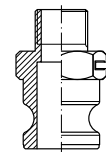

DN	THREAD ROSCA	Part n° Referencia	€
12	1/2"	ZF012	7,39
20	1/2"	ZF015	7,69
20	3/4"	ZF020	9,09
25	1"	ZF025	12,69
32	1"1/4	ZF032	17,15
40	1"1/2	ZF040	26,54
50	2"	ZF050	30,86
65	2"1/2	ZF065	49,48
80	3"	ZF080	61,81
100	4"	ZF100	97,70

Serie Camlock DIN 2828

DIN 2828 Camlock Fittings
Raccords Camlock DIN 2828
Camlock DIN 2828

Camlock hembra - tapón Tipo DC

Female Camlock Coupling-Dust caps Type DC

Bouchon Camlock femelle Type DC

Tappo di protezione Camlock Tipo DC

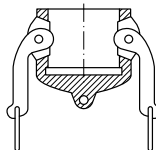

DN	Part n° Referencia	€
12	ZDC012	12,32
20	ZDC020	14,90
25	ZDC025	18,42
32	ZDC032	27,26
40	ZDC040	27,14
50	ZDC050	35,11
65	ZDC065	44,72
80	ZDC080	60,11
100	ZDC100	84,67

Junta Camlock NBR

Camlock NBR Seal

Joint Camlock NBR

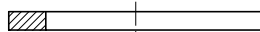

Guarnizione in NBR per Camlock

DN	Part n° Referencia	€
12	JCAMNBR012	0,85
20	JCAMNBR020	0,85
25	JCAMNBR025	1,48
32	JCAMNBR032	1,77
40	JCAMNBR040	1,91
50	JCAMNBR050	3,07
65	JCAMNBR065	3,97
80	JCAMNBR080	3,50
100	JCAMNBR100	4,30

Camlock macho - tapón tipo DP

Male Camlock coupling-Dust plugs Type DP

Bouchon Camlock mâle Type DP

Cappuccio di protezione Camlock Tipo DP

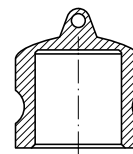

DN	Part n° Referencia	€
12	ZDP012	5,76
20	ZDP020	7,04
25	ZDP025	9,39
32	ZDP032	13,98
40	ZDP040	15,73
50	ZDP050	22,50
65	ZDP065	38,41
80	ZDP080	46,04
100	ZDP100	73,51

Junta Camlock silicona

Camlock silicone seal

Joint Camlock silicone

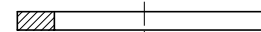

Guarnizione in silicone per Camlock

DN	Part n° Referencia	€
12	JCAMS012	2,27
20	JCAMS020	2,27
25	JCAMS025	2,67
32	JCAMS032	4,28
40	JCAMS040	5,74
50	JCAMS050	6,47
65	JCAMS065	7,49
80	JCAMS080	11,18
100	JCAMS100	14,97

Serie Camlock DIN 2828

DIN 2828 Camlock Fittings
Raccords Camlock DIN 2828
Camlock DIN 2828

Camlock macho - rosca hembra NPT Tipo A

Male Camlock coupling, female NPT threaded
Type A

Adapteur Camlock mâle - filetage femelle NPT
Type A

Adattatore Camlock maschio-filettatura femmina
NPT Tipo A

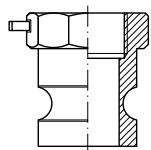

DN	THREAD ROSCA	Part nº Referencia	€
12	1/2"	ZA012NPT	6,28
20	3/4"	ZA020NPT	8,61
25	1"	ZA025NPT	11,79
32	1" 1/4	ZA032NPT	15,88
40	1" 1/2	ZA040NPT	21,65
50	2"	ZA050NPT	25,79
65	2" 1/2	ZA065NPT	41,04
80	3"	ZA080NPT	52,25
100	4"	ZA100NPT	75,52

Camlock hembra - rosca macho NPT Tipo B

Female Camlock Coupling, female NPT threaded
Type B

Adapteur Camlock femelle - filetage mâle NPT
Type B

Adattatore Camlock femmina-filettatura maschio
NPT Tipo B

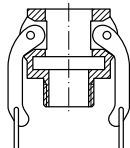

DN	THREAD ROSCA	Part nº Referencia	€
12	1/2"	ZB012NPT	14,45
20	3/4"	ZB020NPT	14,52
25	1"	ZB025NPT	19,50
32	1" 1/4	ZB032NPT	27,59
40	1" 1/2	ZB040NPT	29,25
50	2"	ZB050NPT	39,51
65	2" 1/2	ZB065NPT	51,14
80	3"	ZB080NPT	72,23
100	4"	ZB100NPT	101,85

Camlock hembra - rosca hembra NPT Tipo D

Female Camlock Coupling, female NPT threaded
Type D

Adapteur Camlock femelle NPT Type D

Adattatore Camlock femmina NPT Tipo D

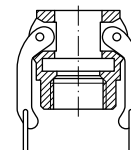

DN	THREAD ROSCA	Part nº Referencia	€
12	1/2"	ZD012NPT	12,71
20	3/4"	ZD020NPT	14,37
25	1"	ZD025NPT	19,76
32	1" 1/4	ZD032NPT	30,06
40	1" 1/2	ZD040NPT	30,20
50	2"	ZD050NPT	42,19
65	2" 1/2	ZD065NPT	51,66
80	3"	ZD080NPT	66,96
100	4"	ZD100NPT	105,75

Camlock macho - rosca macho NPT Tipo F

Male Camlock coupling, male NPT threaded Type F

Adapteur Camlock mâle NPT Type F

Adattatore Camlock maschio NPT Tipo F

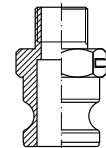

DN	THREAD ROSCA	Part nº Referencia	€
12	1/2"	ZF012NPT	7,39
20	3/4"	ZF020NPT	9,09
25	1"	ZF025NPT	12,69
32	1" 1/4	ZF032NPT	17,15
40	1" 1/2	ZF040NPT	26,54
50	2"	ZF050NPT	30,86
65	2" 1/2	ZF065NPT	48,51
80	3"	ZF080NPT	61,81
100	4"	ZF100NPT	97,70

CAMLOCK NPT



EN 14420-7 | DIN 2828

Ver ficha técnica | Check technical sheet

Para una amplia gama de aplicaciones como agua petróleo y productos químicos
For a wide range of applications such as water, petroleum and chemical liquids

Serie Camlock DIN 2828

DIN 2828 Camlock Fittings
Raccords Camlock DIN 2828
Camlock DIN 2828

Autolock hembra - rosca macho BSP Tipo B

Autolock, female, BSP male threaded Type B

Autolock femelle - filetage mâle BSP Type B

Autolock femmina-filettatura maschio Tipo B



DN	THREAD ROSCA	Part nº Referencia	€
12	1/2"	ZB012S	23,96
20	3/4"	ZB020S	22,12
25	1"	ZB025S	30,80
32	1"1/4	ZB032S	47,78
40	1"1/2	ZB040S	56,85
50	2"	ZB050S	68,23
65	2"1/2	ZB065S	90,15
80	3"	ZB080S	124,47
100	4"	ZB100S	164,85

Autolock hembra - rosca hembra BSP Tipo D

Autolock, female, BSP female threaded Type D

Autolock femelle - filetage femelle BSP Type D

Autolock femmina - filettatura femmina Tipo D



DN	THREAD ROSCA	Part nº Referencia	€
12	1/2"	ZD012S	23,96
20	3/4"	ZD020S	21,94
25	1"	ZD025S	32,21
32	1"1/4	ZD032S	49,52
40	1"1/2	ZD040S	58,47
50	2"	ZD050S	69,62
65	2"1/2	ZD065S	93,05
80	3"	ZD080S	124,56
100	4"	ZD100S	178,46

Autolock hembra - para manguera Tipo C

Autolock, female, with serrated hose shank Type C

Autolock femelle - pour tuyau Type C

Autolock femmina - per tubo Tipo C



DN	THREAD ROSCA	Part nº Referencia	€
12	1/2"	ZC012S	26,19
20	3/4"	ZC020S	27,64
25	1"	ZC025S	35,18
32	1"1/4	ZC032S	51,04
40	1"1/2	ZC040S	59,38
50	2"	ZC050S	74,84
65	2"1/2	ZC065S	104,63
80	3"	ZC080S	137,77
100	4"	ZC100S	194,09

Autolock hembra - tapón Tipo DC

Autolock, female, DC type dust cap

Autolock femelle - bouchon Type DC

Autolock femmina - Tappo di protezione Tipo DC



DN	Part nº Referencia	€
12	ZDC012S	21,14
20	ZDC020S	23,42
25	ZDC025S	27,87
32	ZDC032S	43,71
40	ZDC040S	48,50
50	ZDC050S	61,80
65	ZDC065S	78,12
80	ZDC080S	102,18
100	ZDC100S	137,18

AUTOLOCK

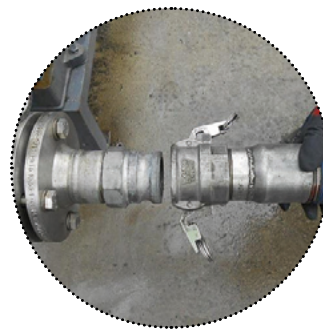

Camlock con cierre de seguridad, múltiples aplicaciones como agua, petróleo y productos químicos

Camlock with security lock, for multiple applications such as water, petroleum and chemical liquids

Ver ficha técnica | Check technical sheet

Acoples GUILLEMIN NF E-29572

GUILLEMIN NF E-29572 Fittings
Raccords GUILLEMIN NF E-29572
Raccordi GUILLEMIN NF E-29572

Crimping fittings for hoses

Pipe fittings

Pipe fittings II

Adaptors

Welding fittings

Industrial fittings

Accessories

Control components

Flow measuring

Tri/Le LOK

GUILLEMIN con cierre-rosca hembra BSP

GUILLEMIN S.S. with closure-BSP Female thread

GUILLEMIN Inox avec fermeture-Filetage
Femelle BSP

GUILLEMIN Inox con chiusura-Filetto femmina
BSP



DN	THREAD ROSCA	Part n° Referencia	€
20	3/4"	ZGU01C020	24,16
25	1"	ZGU01C025	32,84
32	1" 1/4	ZGU01C032	39,26
40	1" 1/2	ZGU01C040	62,69
50	2"	ZGU01C050	62,21
65	2" 1/2	ZGU01C065	87,59
80	3"	ZGU01C080	124,87
100	4"	ZGU01C100	212,00

GUILLEMIN sin cierre-rosca hembra BSP

GUILLEMIN S.S. without closure-BSP Female
thread

GUILLEMIN Inox sans fermeture-Filetage
Femelle BSP

GUILLEMIN Inox senza chiusura-Filetto femmina
BSP



DN	THREAD ROSCA	Part n° Referencia	€
20	3/4"	ZGU01S020	15,10
25	1"	ZGU01S025	14,52
32	1" 1/4	ZGU01S032	20,57
40	1" 1/2	ZGU01S040	29,04
50	2"	ZGU01S050	33,22
65	2" 1/2	ZGU01S065	45,30
80	3"	ZGU01S080	74,05
100	4"	ZGU01S100	87,59

GUILLEMIN con cierre-rosca macho BSP

GUILLEMIN S.S. with closure-BSP Male thread

GUILLEMIN Inox avec fermeture-Filetage Mâle
BSP

GUILLEMIN Inox con chiusura-Filetto maschio
BSP



DN	THREAD ROSCA	Part n° Referencia	€
20	3/4"	ZGU02C020	18,12
25	1"	ZGU02C025	21,14
32	1" 1/4	ZGU02C032	27,19
40	1" 1/2	ZGU02C040	35,65
50	2"	ZGU02C050	63,10
65	2" 1/2	ZGU02C065	84,99
80	3"	ZGU02C080	125,22
100	4"	ZGU02C100	160,07

GUILLEMIN sin cierre-rosca macho BSP

GUILLEMIN S.S. without closure-BSP Male thread

GUILLEMIN Inox sans fermeture-Filetage Mâle
BSP

GUILLEMIN Inox senza chiusura-Filetto maschio
BSP



DN	THREAD ROSCA	Part n° Referencia	€
20	3/4"	ZGU02S020	14,52
25	1"	ZGU02S025	18,12
32	1" 1/4	ZGU02S032	22,55
40	1" 1/2	ZGU02S040	21,38
50	2"	ZGU02S050	38,07
65	2" 1/2	ZGU02S065	46,46
80	3"	ZGU02S080	75,50
100	4"	ZGU02S100	99,66

GUILLEMIN con cierre-tapón

GUILLEMIN S.S. with closure-Plug

GUILLEMIN Inox avec fermeture-Bouchon

GUILLEMIN Inox con chiusura-Tappo



DN	Part n° Referencia	€
20	ZGU04C020	18,12
25	ZGU04C025	18,12
32	ZGU04C032	24,78
40	ZGU04C040	32,35
50	ZGU04C050	45,30
65	ZGU04C065	60,40
80	ZGU04C080	84,22
100	ZGU04C100	150,51

GUILLEMIN con cierre-reductor

GUILLEMIN S.S. with closure-Reducer

GUILLEMIN Inox avec fermeture-Réduction

GUILLEMIN Inox con chiusura-Riduzione



DN	Part n° Referencia	€
40-32	ZGU03C040032	116,16
50-40	ZGU03C050040	116,16
65-50	ZGU03C065050	154,03
80-65	ZGU03C080065	232,55
100-80	ZGU03C100080	302,02

GUILLEMIN con cierre-para manguera

GUILLEMIN S.S. with closure-For hose

GUILLEMIN Inox avec fermeture-Pour tuyau

GUILLEMIN Inox con chiusura-Per tubo



DN	L (mm)	SIZE TAMAÑO	Part n° Referencia	€
40	37	40	ZGU05C040040	36,17
45	37	40	ZGU05C040045	37,75
50	48	50	ZGU05C050050	68,13
50	45,5	50	ZGU05C050055	66,79
65	50	65	ZGU05C065065	91,41
80	70	80	ZGU05C080080	147,61

Acoples GUILLEMIN NF E-29572

GUILLEMIN NF E-29572 Fittings
Raccords GUILLEMIN NF E-29572
Raccordi GUILLEMIN NF E-29572

GUILLEMIN con cierre-soldable

GUILLEMIN S.S. with closure-Welding

GUILLEMIN Inox avec fermeture-À souder

GUILLEMIN Inox con chiusura-Saldabile



DN	Part n° Referencia	€
40	ZGU06C040040	39,26
50	ZGU06C050050	64,33
65	ZGU06C065065	87,59
80	ZGU06C080080	132,89

GUILLEMIN



EN 14420-8 | NF E-29572

Ver ficha técnica | Check technical sheet

Aplicaciones de presión y aspiración en un amplio rango de industrias

Pressure and suction purposes in a wide range of industries

Acoples TW (Tankwagen) DIN 28450

TW (Tankwagen) DIN 28450 Fittings
Raccords TW (Tankwagen) DIN 28450
Raccordi TW (Tankwagen) DIN 28450

TW rosca hembra BSP - acople hembra

TW BSP Female thread - female coupling

TW Filetage Femelle BSP - accouplement Femelle

TW Filetto femmina BSP - accoppiamento femmina



DN	Part n° Referencia	€
2"	ZMK05032	65,72
3"	ZMK08048	123,87
4"	ZMK10064	235,88

TW rosca hembra BSP - acople macho

TW BSP Female thread - male coupling

TW Filetage Femelle BSP - accouplement Mâle

TW Filetto femmina BSP - accoppiamento maschio



DN	Ø	Part n° Referencia	€
2"	70.5	ZVK05032	29,00
3"	102	ZVK08048	64,04
4"	128	ZVK10064	92,30

TW tapón - acople hembra

TW Plug - female coupling

TW Bouchon - accouplement Femelle

TW Tappo - accoppiamento femmina



DN	Part n° Referencia	€
2"	ZMB050	28,85
3"	ZMB080	58,54
4"	ZMB100	97,39

TW tapón - acople macho

TW Plug - male coupling

TW Bouchon - accouplement Mâle

TW Tappo - accoppiamento maschio



DN	Ø	Part n° Referencia	€
2"	70.5	ZVB050	24,73
3"	102	ZVB080	47,41
4"	128	ZVB100	76,38

TW acople hembra

TW Female coupling

TW Accouplement Femelle

TW Accoppiamento femmina



DN	Part n° Referencia	€
2"	ZMKS050050	81,72
3"	ZMKS080080	173,18

TW acople macho

TW Male coupling

TW Accouplement Mâle

TW Accoppiamento maschio



DN	Part n° Referencia	€
2"	ZVKS050050	52,43
3"	ZVKS080080	122,87

Accesorios inox para racor industrial

Stainless Steel accessories for industrial fitting

Accessoires acier inox pour raccord industriel

Accessori in acciaio inossidabile per raccordo industriale

Campana inox para racor industrial - cierre 45°

Stainless Steel Crimping Ferrule 45° closure

Jupe pour raccord industriel acier inox -fermeture 45°

Boccola in acciaio inossidabile per raccordo industriale-chiusura 45°



DN	Ø INNER Ø INT.	Part n° Referencia	€
25	42	ZCA025	6,17
32	50	ZCA032	8,09
40	58	ZCA040	9,18
50	67	ZCA050	14,17
50	71	ZCA05001	29,46
65	83	ZCA065	27,24
80	98	ZCA080	32,71
100	120	ZCA100	61,68

Abrazadera EN 14420-3 inox para racor industrial

Stainless Steel clamp for industrial fitting EN14420-3

Collier pour raccord industriel acier inox EN 14420-3

Collare EN 14420 in acciaio inossidabile per raccordo industriale



Ø HOSE Ø MANGUERA	Ø INNER Ø INT.	Part n° Referencia	€
12	21-25	ZAB01021025	16,24
19	29-33	ZAB01029033	20,38
25	35-39	ZAB01035039	21,69
25	36-39	ZAB01036039	21,69
32	42-46	ZAB01042046	22,34
38	47-51	ZAB01047051	24,24
38	49-53	ZAB01049053	23,76
38	52-56	ZAB01052056	26,03
38	58-62	ZAB01058062	23,76
50	60-64	ZAB01060064	38,51
50	63-67	ZAB01063067	37,75
50	68-72	ZAB01068072	44,70
63	74-77	ZAB01074077	52,59
63	77-81	ZAB01077081	66,45
75	87-90	ZAB01087090	72,88
75	89-94	ZAB01089094	79,25
75	94-98	ZAB01094098	81,30
100	114-119	ZAB01114119	168,84

Abrazadera alta presión W4 inox

Stainless steel high pressure clamp W4

Collier haute pression W4 acier inox.

Collare alta pressione W4, inoss.



Ø INNER Ø INT.	Part n° Referencia	€
17-19	ZAB02017019	3,81
20-22	ZAB02020022	3,87
23-25	ZAB02023025	3,93
26-28	ZAB02026028	3,98
29-31	ZAB02029031	4,84
32-35	ZAB02032035	4,95
36-39	ZAB02036039	5,01
40-43	ZAB02040043	5,08
44-47	ZAB02044047	5,55
48-51	ZAB02048051	5,68
52-55	ZAB02052055	5,86
56-59	ZAB02056059	5,98
60-63	ZAB02060063	6,10
64-67	ZAB02064067	6,22
68-73	ZAB02068073	8,04
74-79	ZAB02074079	8,28
80-85	ZAB02080085	8,46
86-91	ZAB02086091	8,69
92-97	ZAB02092097	8,88
98-103	ZAB02098103	9,25
104-112	ZAB02104112	9,42
113-121	ZAB02113121	9,66
122-130	ZAB02122130	9,85
131-139	ZAB02131139	13,17
140-148	ZAB02140148	13,41
149-161	ZAB02149161	13,59
162-174	ZAB02162174	13,89
175-187	ZAB02175187	14,56
188-200	ZAB02188200	14,92

Racores baja presión 150 LBS

Screw low pressure fittings 150 LBS (Male BSPT / Female BSP)
Raccords basse pression 150 LBS (Mâle BSPT / Femelle BSP)
Raccordi bassa pressione 150 LBS (Maschio BSPT / Femmina BSP)

Macho fijo espiga FIG.399

Nipple fixed male fig.399

Mâle fixe nipple fig. 399 inox

Maschio fisso fig. 399 inox

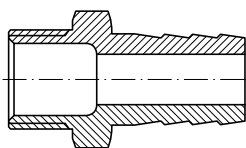

DN	THREAD ROSCA	Part nº Referencia	€
10	1/4"	ZFIG39904	2,59
12	3/8"	ZFIG39906	3,10
15	1/2"	ZFIG39908	3,71
20	3/4"	ZFIG39912	6,40
25	1"	ZFIG39916	9,03
32	1" 1/4	ZFIG39920	14,12
40	1" 1/2	ZFIG39924	16,84
52	2"	ZFIG39932	26,55

Unión macho-macho FIG.150

Union male-male fig.150

Union mâle-mâle fig.150 inox

Unione maschio-maschio fig.150 inox

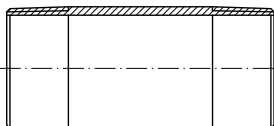

THREAD ROSCA	Part nº Referencia	€
1/4"	ZFIG15004	1,89
3/8"	ZFIG15006	2,17
1/2"	ZFIG15008	3,36
3/4"	ZFIG15012	4,42
1"	ZFIG15016	6,24
1" 1/4	ZFIG15020	9,67
1" 1/2	ZFIG15024	11,97
2"	ZFIG15032	18,01

Tapón macho hexagonal FIG.290

Hexagon male plug FIG.290

Bouchon mâle 150 LBS tête hexagonale FIG.290

Tappo maschio esagonale FIG.290

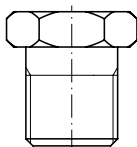

THREAD ROSCA	Part nº Referencia	€
1/8"	ZFIG29002	1,61
1/4"	ZFIG29004	1,68
3/8"	ZFIG29006	1,95
1/2"	ZFIG29008	2,63
3/4"	ZFIG29012	4,14
1"	ZFIG29016	5,53
1"1/4	ZFIG29020	7,85
1"1/2	ZFIG29024	10,16
2"	ZFIG29032	16,05
2"1/2	ZFIG29040	25,50
3"	ZFIG29048	39,80
4"	ZFIG29060	60,89

Adaptador hexagonal FIG.280

Hexagon nipple FIG.280

Mamelon hexagonal 150 LBS FIG.280

Niples esagonale FIG.280

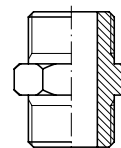

THREAD ROSCA	Part nº Referencia	€
1/4"	ZFIG28004	1,89
3/8"	ZFIG28006	2,36
1/2"	ZFIG28008	3,64
3/4"	ZFIG28012	5,12
1"	ZFIG28016	7,55
1"1/4	ZFIG28020	9,56
1"1/2	ZFIG28024	12,94
2"	ZFIG28032	22,10
2"1/2	ZFIG28040	38,75
3"	ZFIG28048	49,79
4"	ZFIG28060	73,85

Reducción macho-macho FIG.245

Reducer male-male fig. 245

Réduction mâle-mâle fig. 245 inox

Riduzione maschio-maschio fig. 245 inox

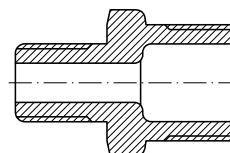

THREAD ROSCA	Part nº Referencia	€
1/4" 1/8"	ZFIG2450402	1,82
3/8" 1/4"	ZFIG2450604	2,31
1/2" 1/4"	ZFIG2450804	3,30
1/2" 3/8"	ZFIG2450806	2,83
3/4" 3/8"	ZFIG2451206	3,99
3/4" 1/2"	ZFIG2451208	4,45
1" 1/2"	ZFIG2451608	6,66
1" 3/4"	ZFIG2451612	6,02
1" 1/4 3/4"	ZFIG2452012	7,78
1" 1/4 1"	ZFIG2452016	9,60
1" 1/2 1"	ZFIG2452416	11,14
1" 1/2 1" 1/4	ZFIG2452420	11,14
2" 1" 1/4	ZFIG2453220	15,13
2" 1" 1/2	ZFIG2453224	17,23
2" 1/2 2"	ZFIG2454032	29,78
3" 2" 1/2	ZFIG2454840	49,19

Tuerca plana FIG.312

Flat nut fig.312

Écrou plat fig.312 inox

Dado piano fig.312 inox

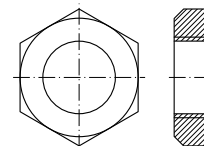

THREAD ROSCA	Part nº Referencia	€
1/4"	ZFIG31204	1,54
3/8"	ZFIG31206	1,68
1/2"	ZFIG31208	1,75
3/4"	ZFIG31212	2,38
1"	ZFIG31216	3,02
1" 1/4	ZFIG31220	4,20
1" 1/2	ZFIG31224	5,61
2"	ZFIG31232	8,55

Racores baja presión 150 LBS

Screw low pressure fittings 150 LBS (Male BSPT / Female BSP)
Raccords basse pression 150 LBS (Mâle BSPT / Femelle BSP)
Raccordi bassa pressione 150 LBS (Maschio BSPT / Femmina BSP)

Tapón hembra hexagonal FIG.300

Hexagon female cap. FIG.300

Bouchon femelle hexagonal 150 LBS FIG.300

Tappo femmina esagonale FIG.300

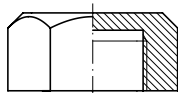

THREAD ROSCA	Part nº Referencia	€
1/8"	ZFIG30002	2,03
1/4"	ZFIG30004	2,17
3/8"	ZFIG30006	2,17
1/2"	ZFIG30008	3,43
3/4"	ZFIG30012	4,41
1"	ZFIG30016	6,02
1"1/4	ZFIG30020	8,90
1"1/2	ZFIG30024	11,23
2"	ZFIG30032	15,90
2"1/2	ZFIG30040	25,01
3"	ZFIG30048	36,58
4"	ZFIG30060	70,42

Adaptador hembra BSP DIN 2986 FIG.270

BSP Female coupling DIN 2986 FIG.270

Manchon femelle gaz DIN 2986 150 LBS FIG.270

Adattatore femmina BSP DIN 2986 FIG.270

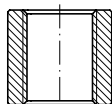

THREAD ROSCA	Part nº Referencia	€
1/4"	ZFIG27004	2,65
3/8"	ZFIG27006	2,69
1/2"	ZFIG27008	4,12
3/4"	ZFIG27012	5,05
1"	ZFIG27016	8,06
1"1/4	ZFIG27020	10,71
1"1/2	ZFIG27024	13,08
2"	ZFIG27032	19,15
2"1/2	ZFIG27040	34,12
3"	ZFIG27048	44,92
4"	ZFIG27060	75,68

Tapón macho cuadrado FIG.291

Male square plug FIG.291

Bouchon mâle 150 LBS tête carrée FIG.291

Tappo maschio testa quadrata FIG.291

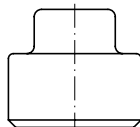

THREAD ROSCA	Part nº Referencia	€
1/8"	ZFIG29102	1,68
1/4"	ZFIG29104	1,75
3/8"	ZFIG29106	1,89
1/2"	ZFIG29108	2,17
3/4"	ZFIG29112	3,43
1"	ZFIG29116	4,63
1"1/4	ZFIG29120	6,33
1"1/2	ZFIG29124	8,20
2"	ZFIG29132	13,18
2"1/2	ZFIG29140	17,45
3"	ZFIG29148	26,82
4"	ZFIG29160	46,08

Tapón hembra redondo FIG.301

Round female cap. FIG.301

Bouchon femelle ronde 150 LBS FIG.301

Tappo femmina rotondo FIG.301

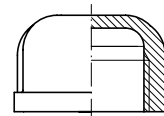

THREAD ROSCA	Part nº Referencia	€
1/8"	ZFIG30102	2,02
1/4"	ZFIG30104	2,02
3/8"	ZFIG30106	2,08
1/2"	ZFIG30108	3,29
3/4"	ZFIG30112	4,36
1"	ZFIG30116	5,92
1"1/4	ZFIG30120	9,75
1"1/2	ZFIG30124	10,49
2"	ZFIG30132	13,24
2"1/2	ZFIG30140	22,91
3"	ZFIG30148	32,27
4"	ZFIG30160	56,19

Hasta fin de existencias / Until end of stock / Jusqu'à la fin du stock / Fino ad esaurimento scorta

Reductor macho-hembra FIG.241

Male-female reducer FIG.241

Réduction 150 LBS MG - FG FIG.241

Riduzione maschio-femmina FIG.241

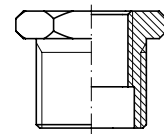

THREAD ROSCA	Part nº Referencia	€	
1/8"	1/4"	ZFIG2410204	1,89
1/4"	3/8"	ZFIG2410406	1,95
1/4"	1/2"	ZFIG2410408	2,82
3/8"	1/2"	ZFIG2410608	2,56
1/2"	3/4"	ZFIG2410812	3,71
3/4"	1"	ZFIG2411216	5,59
1"	1"1/4	ZFIG2411620	8,68
1"	1" 1/2	ZFIG2411624	9,32
1"1/4	1"1/2	ZFIG2412024	9,14
1"1/2	2"	ZFIG2412432	16,22
2"	2"1/2	ZFIG2413240	30,02
2"1/2	3"	ZFIG2414048	37,32
3"	4"	ZFIG2414860	68,53

Tubo roscado FIG.531

Threaded pipe fig. 531

Tube fileté fig. 531 inox

Tubo filettato fig. 531 inox

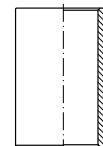

THREAD ROSCA	Part nº Referencia	€
1/4"	ZFIG53104	2,49
3/8"	ZFIG53106	2,76
1/2"	ZFIG53108	3,22
3/4"	ZFIG53112	3,79
1"	ZFIG53116	5,19
1" 1/4	ZFIG53120	7,22
1" 1/2	ZFIG53124	8,34
2"	ZFIG53132	10,92

Racores baja presión 150 LBS

Screw low pressure fittings 150 LBS (Male BSPT / Female BSP)
Raccords basse pression 150 LBS (Mâle BSPT / Femelle BSP)
Raccordi bassa pressione 150 LBS (Maschio BSPT / Femmina BSP)

Reducción hembra-hembra FIG.240

Female-female Reducer socket FIG.240

Réduction Femelle-femelle 150 LBS FIG.240

Riduzione femmina-femmina FIG.240

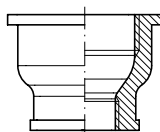

THREAD ROSCA		Part nº Referencia	€
1/4"	1/8"	ZFIG2400402	2,03
3/8"	1/4"	ZFIG2400604	2,66
1/2"	3/8"	ZFIG2400806	3,71
3/4"	1/2"	ZFIG2401208	5,25
1"	3/4"	ZFIG2401612	7,29
1"1/4	1"	ZFIG2402016	10,44
1"1/2	1"1/4	ZFIG2402420	14,08
2"	1"1/2	ZFIG2403224	19,34
2"1/2	2"	ZFIG2404032	30,20
3"	2"	ZFIG2404832	45,54
3"	2"1/2	ZFIG2404840	49,05
4"	2"	ZFIG2406032	69,44

Codo 90° hembra-hembra FIG.090

Female-female elbow 90° FIG.090

Coude 90° 150 LBS femelle gaz FIG.090

Curva 90° femmina-femmina FIG.090

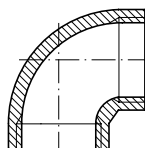

THREAD ROSCA	Part nº Referencia	€
1/8"	ZFIG09002	1,89
1/4"	ZFIG09004	2,22
3/8"	ZFIG09006	2,89
1/2"	ZFIG09008	3,83
3/4"	ZFIG09012	5,59
1"	ZFIG09016	8,46
1"1/4	ZFIG09020	13,11
1"1/2	ZFIG09024	16,89
2"	ZFIG09032	25,43
2"1/2	ZFIG09040	54,16
3"	ZFIG09048	77,07
4"	ZFIG09060	133,54

Codo 45° hembra-hembra FIG.120

Female-female elbow 45° FIG.120

Coude 45° 150 LBS FG - FG FIG.120

Adattatore a 45° femmina-femmina

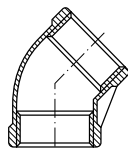

THREAD ROSCA	Part nº Referencia	€
1/8"	ZFIG12002	2,59
1/4"	ZFIG12004	2,86
3/8"	ZFIG12006	3,50
1/2"	ZFIG12008	4,88
3/4"	ZFIG12012	6,67
1"	ZFIG12016	8,55
1"1/4	ZFIG12020	14,36
1"1/2	ZFIG12024	17,59
2"	ZFIG12032	27,19
2"1/2	ZFIG12040	53,19
3"	ZFIG12048	73,30
4"	ZFIG12060	128,89

Codo 90° macho-hembra FIG.092

Male-female elbow 90° FIG.092

Coude 90° 150 LBS MG - FG FIG.092

Adattatore a 90° maschio-femmina FIG.092

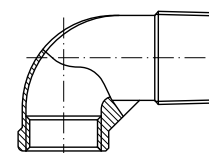

THREAD ROSCA	Part nº Referencia	€
1/8"	ZFIG09202	2,56
1/4"	ZFIG09204	3,30
3/8"	ZFIG09206	3,64
1/2"	ZFIG09208	4,31
3/4"	ZFIG09212	6,27
1"	ZFIG09216	9,23
1"1/4	ZFIG09220	13,24
1"1/2	ZFIG09224	17,12
2"	ZFIG09232	25,98
2"1/2	ZFIG09240	53,26
3"	ZFIG09248	87,80
4"	ZFIG09260	167,47

TE hembra-hembra-hembra FIG.130

Female-female TEE FIG.130

TÉS 150 LBS FG - FG - FG FIG.130

Adattatore a T F - F - F

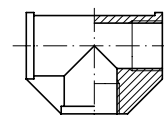

THREAD ROSCA	Part nº Referencia	€
1/8"	ZFIG13002	2,45
1/4"	ZFIG13004	3,67
3/8"	ZFIG13006	3,84
1/2"	ZFIG13008	5,11
3/4"	ZFIG13012	7,96
1"	ZFIG13016	10,92
1"1/4	ZFIG13020	16,29
1"1/2	ZFIG13024	22,21
2"	ZFIG13032	33,19
2"1/2	ZFIG13040	73,23
3"	ZFIG13048	97,31
4"	ZFIG13060	191,63

Cruz roscada FIG.180

Threaded cross FIG.180

Croix égale 150 LBS FG FIG.180

Croce filettata femmina FIG.180

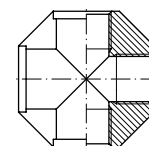

THREAD ROSCA	Part nº Referencia	€
1/8"	ZFIG18002	3,86
1/4"	ZFIG18004	4,84
3/8"	ZFIG18006	5,19
1/2"	ZFIG18008	8,27
3/4"	ZFIG18012	11,56
1"	ZFIG18016	17,10
1"1/4	ZFIG18020	27,26
1"1/2	ZFIG18024	31,89
2"	ZFIG18032	45,82
2"1/2	ZFIG18040	90,32
3"	ZFIG18048	118,18
4"	ZFIG18060	223,62

Racores baja presión 150 LBS

Screw low pressure fittings 150 LBS (Male BSPT / Female BSP)
Raccords basse pression 150 LBS (Mâle BSPT / Femelle BSP)
Raccordi bassa pressione 150 LBS (Maschio BSPT / Femmina BSP)

Unión 3 piezas hembra-hembra FIG.340

Female-female FIG.340

Union 3 pièces 150 LBS FG - FG FIG.340

Unione femmina-femmina FIG.340

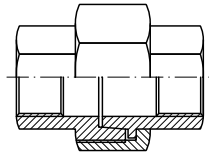

THREAD ROSCA	Part nº Referencia	€
1/8"	ZFIG34002	5,75
1/4"	ZFIG34004	8,23
3/8"	ZFIG34006	9,18
1/2"	ZFIG34008	10,31
3/4"	ZFIG34012	13,68
1"	ZFIG34016	19,55
1" 1/4	ZFIG34020	28,17
1" 1/2	ZFIG34024	32,23
2"	ZFIG34032	48,38
2" 1/2	ZFIG34040	76,66
3"	ZFIG34048	110,85
4"	ZFIG34060	159,72

Unión 3 piezas macho-hembra FIG.341

Male-female union FIG.341

Union 3 pièces 150 LBS MG - FG FIG.341

Unione maschio-femmina FIG.341

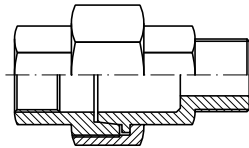

THREAD ROSCA	Part nº Referencia	€
1/4"	ZFIG34104	8,96
3/8"	ZFIG34106	9,67
1/2"	ZFIG34108	11,27
3/4"	ZFIG34112	15,98
1"	ZFIG34116	20,28
1" 1/4	ZFIG34120	30,38
1" 1/2	ZFIG34124	36,01
2"	ZFIG34132	54,63
2" 1/2	ZFIG34140	82,54
3"	ZFIG34148	116,80
4"	ZFIG34160	200,12

Macho soldar FIG.149

Welding male fig.149

Mâle à souder fig.149 inox

Maschio a saldare fig. 149 inox

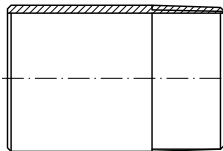

THREAD ROSCA	Part nº Referencia	€
1/4"	ZFIG14904	1,47
3/8"	ZFIG14906	1,68
1/2"	ZFIG14908	2,16
3/4"	ZFIG14912	3,08
1"	ZFIG14916	4,25
1" 1/4	ZFIG14920	6,60
1" 1/2	ZFIG14924	7,35
2"	ZFIG14932	9,91

Unión 3 piezas soldar FIG.340HS microfundido

Union 3 welding pieces fig.340hs micro-casting

Union 3 pièces à souder fig.340hs acier moulé

Unione a 3 pezzi saldare fig.340hs microfusione

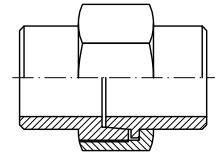

DN	Part nº Referencia	€
1/4"	ZFIG34004S	7,48
3/8"	ZFIG34006S	9,04
1/2"	ZFIG34008S	10,72
3/4"	ZFIG34012S	13,24
1"	ZFIG34016S	18,28
1" 1/4	ZFIG34020S	26,49
1" 1/2	ZFIG34024S	29,43
2"	ZFIG34032S	45,61

Unión 3 piezas hembra-soldar FIG.340S microfundido

Union 3 fem. welding pieces fig. 340s micro-casting

Union 3 pièces fem à souder fig. 340s acier moulé

Unione a 3 pezzi f. a saldare fig.340s microfusione

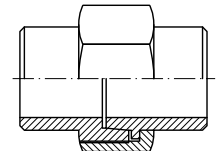

THREAD ROSCA	Part nº Referencia	€
1/4"	ZFIG34004HS	7,91
3/8"	ZFIG34006HS	9,39
1/2"	ZFIG34008HS	10,72
3/4"	ZFIG34012HS	13,59
1"	ZFIG34016HS	17,93
1" 1/4	ZFIG34020HS	27,47
1" 1/2	ZFIG34024HS	32,02
2"	ZFIG34032HS	48,07

Unión 3 piezas macho-soldar FIG.341MS microfundido

Union 3 welding male pieces fig.341ms micro-casting

Union 3 pcs mâle à souder fig.341ms acier moulé

Unione a 3 pezzi m.saldare fig.341ms microfusione

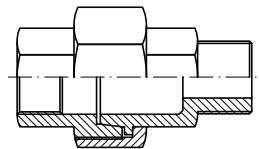

THREAD ROSCA	Part nº Referencia	€
1/4"	ZFIG34104MS	8,48
3/8"	ZFIG34106MS	9,46
1/2"	ZFIG34108MS	11,14
3/4"	ZFIG34112MS	15,13
1"	ZFIG34116MS	20,53
1" 1/4	ZFIG34120MS	29,62
1" 1/2	ZFIG34124MS	35,25
2"	ZFIG34132MS	53,60

Racores baja presión 150 LBS

Screw low pressure fittings 150 LBS (Male BSPT / Female BSP)
 Raccords basse pression 150 LBS (Mâle BSPT / Femelle BSP)
 Raccordi bassa pressione 150 LBS (Maschio BSPT / Femmina BSP)

Válvula esfera paso total baja presión 3 piezas

Ball-valve low pressure full bore 3 pcs

Robinet basse pression 2 voies boisseau
 sphérique passage total 3 pcs

Rubinetto a sfera bassa pressione 3 pcs

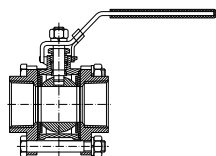

THREAD ROSCA	Part nº Referencia	€
1/4 BSP	BP2V3P14INOX	28,10
3/8 BSP	BP2V3P38INOX	28,10
1/2 BSP	BP2V3P12INOX	35,60
3/4 BSP	BP2V3P34INOX	43,10
1" BSP	BP2V3P11INOX	60,92
1" 1/4 BSP	BP2V3P114INOX	92,99
1" 1/2 BSP	BP2V3P112INOX	123,12
2" BSP	BP2V3P21INOX	172,93

Válvula esfera paso total baja presión 64 Bar

Ball-valve low pressure full bore 64 Bar

Robinet basse pression 2 voies boisseau
 sphérique passage total 64 Bar

Rubinetto a sfera bassa pressione passaggio
 totale 64 Bar

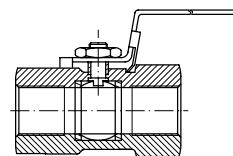

DN	THREAD ROSCA	Part nº Referencia	€
8	1/4" BSP	BP2V14INOX	17,11
10	3/8" BSP	BP2V38INOX	17,45
15	1/2" BSP	BP2V12INOX	20,01
20	3/4" BSP	BP2V34INOX	28,84
25	1" BSP	BP2V11INOX	39,62
32	1"1/4 BSP	BP2V114INOX	63,64
40	1"1/2 BSP	BP2V112INOX	84,56
50	2" BSP	BP2V21INOX	130,98
65	2"1/2 BSP	BP2V212INOX	270,19
80	3" BSP	BP2V31INOX	385,74

Accesorios

Accessories

Accessoires

Accessori

Enchufes rápidos AISI 316

214

Quick couplings AISI 316
Coupleurs rapides AISI 316
Innesti rapidi AISI 316

Llaves de paso AISI 316

217

Ball valves AISI 316
Robinets AISI 316
Rubinetti AISI 316

Racores giratorios AISI 316 TrΔle

220

Quick couplings, ball valves and swivel fittings AISI 316 TrΔle
Coupleurs rapides, robinets et raccords tournants AISI 316 TrΔle
Innesti rapidi, rubinetti e giunti girevole AISI 316 TrΔle

7

Enchufes rápidos AISI 316

Quick couplings AISI 316
Coupleurs rapides AISI 316
Innesti rapidi AISI 316

■ Enchufes rápidos / Quick couplings / Quick release couplings / Innesti rapidi

| 214

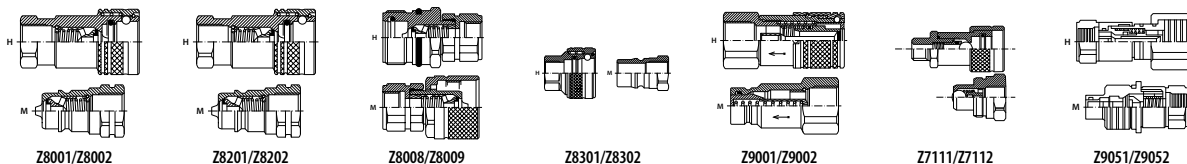

■ Enchufes rápidos TrΔle / Quick couplings TrΔle / Coupleurs rapides TrΔle / Innesti rapidi TrΔle

| 216

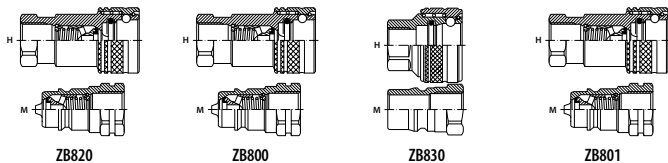

Llaves de paso AISI 316

Ball valves AISI 316
Robinets AISI 316
Rubinetti AISI 316

■ Llaves de paso / Ball valves / Robinets / Rubinetti

| 217

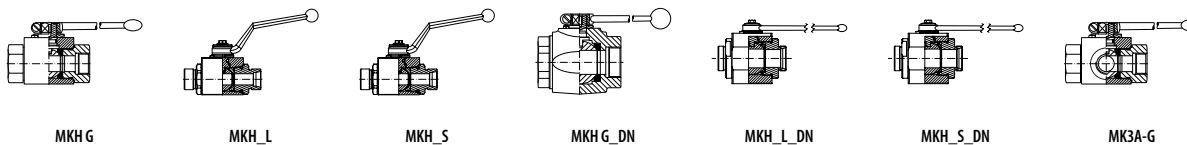

■ Llave 2 vías TrΔle / 2 ways TrΔle ball valve / Robinet 2 voies TrΔle / Rubinetto a sfera TrΔle

| 219



■ Manetas / Handles / Leviers / Manopole

| 219

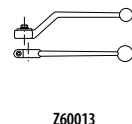

Racores giratorios AISI 316 TrΔle

Quick couplings, ball valves and swivel fittings AISI 316 TrΔle
 Coupleurs rapides, robinets et raccords tournants AISI 316 TrΔle
 Innesti rapidi, rubinetti e giunti girevole AISI 316 TrΔle

- Racores giratorios TrΔle / Swivel fittings TrΔle / Raccords tournants TrΔle / Giunti girevole TrΔle

| 220

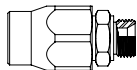

ZGGL



ZGG90

Enchufes rápidos AISI 316

Quick couplings AISI 316
Coupleurs rapides AISI 316
Innesti rapidi AISI 316

Enchufes de punzón ISO B

Quick coupling ISO B

Coupleurs rapides à clapet

Innesti a valvola ISO B

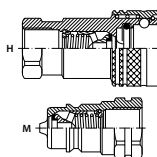

THREAD ROSCA	ISO SIZE TAMAÑO ISO	BG SIZE TAMAÑO BG	C. E.	Part nº Referencia	€
1/4" BSP	6,3	1	M	Z800104	41,00
3/8" BSP	10	2	M	Z800106	45,56
1/2" BSP	12,5	3	M	Z800108	52,99
3/4" BSP	20	4	M	Z800112	91,11
1" BSP	25	5	M	Z800116	141,73
1"1/4 BSP	40	7	M	Z800120	470,95
1"1/2 BSP	40	7	M	Z800124	476,49
2" BSP	50	8	M	Z800132	*
1/4" BSP	6,3	1	F	Z800204	91,11
3/8" BSP	10	2	F	Z800206	102,50
1/2" BSP	12,5	3	F	Z800208	134,67
3/4" BSP	20	4	F	Z800212	199,88
1" BSP	25	5	F	Z800216	272,59
1"1/4 BSP	40	7	F	Z800220	687,03
1"1/2 BSP	40	7	F	Z800224	687,03
2" BSP	50	8	F	Z800232	*

Enchufes de punzón ISO A

Quick coupling ISO A

Coupleurs rapides à clapet ISO A

Innesti a valvola ISO A

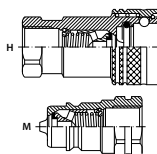

THREAD ROSCA	ISO SIZE TAMAÑO ISO	BG SIZE TAMAÑO BG	C. E.	Part nº Referencia	€
3/8" BSP	10	2	M	Z820106	45,99
1/2" BSP	12,5	3	M	Z820108	53,58
3/4" BSP	20	4	M	Z820112	86,43
1" BSP	25	5	M	Z820116	144,05
1"1/4 BSP	31,5	6	M	Z820120	343,51
1"1/2 BSP	40	7	M	Z820124	476,49
2" BSP	50	8	M	Z820132	*
3/8" BSP	10	2	F	Z820206	126,48
1/2" BSP	12,5	3	F	Z820208	115,24
3/4" BSP	20	4	F	Z820212	178,63
1" BSP	25	5	F	Z820216	257,64
1"1/4 BSP	31,5	6	F	Z820220	681,49
1"1/2 BSP	40	7	F	Z820224	858,78
2" BSP	50	8	F	Z820232	*

Enchufes autoroscantes

Quick screw couplings

Coupleur rapide à visser filetage

Innesti rapidi a vite

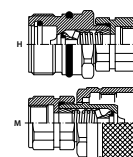

THREAD ROSCA	ISO SIZE TAMAÑO ISO	BG SIZE TAMAÑO BG	C. E.	Part nº Referencia	€
1/4" BSP	6,3	1	M	Z800804	174,25
3/8" BSP	10	2	M	Z800806	114,69
1/2" BSP	12,5	3	M	Z800808	138,51
3/4" BSP	20	4	M	Z800812	228,82
1" BSP	25	5	M	Z800816	299,19
1"1/4 BSP	40	7	M	Z800820	*
1"1/2 BSP	40	7	M	Z800824	*
1/4" BSP	6,3	1	F	Z800904	*
3/8" BSP	10	2	F	Z800906	99,73
1/2" BSP	12,5	3	F	Z800908	121,89
3/4" BSP	20	4	F	Z800912	193,92
1" BSP	25	5	F	Z800916	259,30
1"1/4 BSP	40	7	F	Z800920	779,00
1"1/2 BSP	40	7	F	Z800924	779,00

Enchufes paso total ISO B

Quick coupling free flow ISO B

Coupleurs rapides passage total ISO B

Innesti a passaggio libero

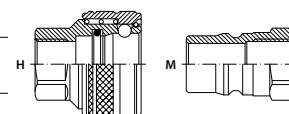

THREAD ROSCA	ISO SIZE TAMAÑO ISO	BG SIZE TAMAÑO BG	C. E.	Part nº Referencia	€
1/8" BSP	5	0	M	Z830102	29,43
1/4" BSP	6,3	1	M	Z830104	30,29
3/8" BSP	10	2	M	Z830106	32,95
1/2" BSP	12,5	3	M	Z830108	36,36
3/4" BSP	20	4	M	Z830112	63,95
1" BSP	25	5	M	Z830116	89,30
1"1/4 BSP	40	7	M	Z830120	217,66
1"1/2 BSP	40	7	M	Z830124	217,66
2" BSP	50	8	M	Z830132	*
1/8" BSP	5	0	F	Z830202	81,50
1/4" BSP	6,3	1	F	Z830204	82,82
3/8" BSP	10	2	F	Z830206	99,91
1/2" BSP	12,5	3	F	Z830208	115,46
3/4" BSP	20	4	F	Z830212	163,61
1" BSP	25	5	F	Z830216	253,11
1"1/4 BSP	40	7	F	Z830220	425,17
1"1/2 BSP	40	7	F	Z830224	425,17
2" BSP	50	8	F	Z830232	*

Enchufes rápidos AISI 316

Quick couplings AISI 316
Coupleurs rapides AISI 316
Innesti rapidi AISI 316

Enchufes de válvula plana ISO16028

Flat face quick coupling ISO16028

Coupleurs à clapet face plane ISO16028

Innesti a faccia piana ISO16028

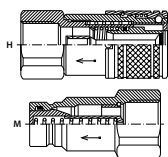

THREAD ROSCA	ISO SIZE TAMAÑO ISO	BG SIZE TAMAÑO BG	C. E.	Part nº Referencia	€
1/4" BSP	6,3	1	M	Z900104	154,73
3/8" BSP	10	2	M	Z900106	191,00
1/2" BSP	12,5	3	M	Z900108	219,20
3/4" BSP	16	4	M	Z900112	299,93
1" BSP	19	5	M	Z900116	323,75
1"1/4 BSP	25	5	M	Z900120	293,26
1"1/2 BSP	40	7	M	Z900124	637,78
2" BSP	50	8	M	Z900132	*
1/4" BSP	6,3	1	F	Z900204	238,99
3/8" BSP	10	2	F	Z900206	285,50
1/2" BSP	12,5	3	F	Z900208	333,23
3/4" BSP	20	4	F	Z900212	445,49
1" BSP	25	5	F	Z900216	491,18
1"1/4 BSP	25	5	F	Z900220	740,28
1"1/2 BSP	40	7	F	Z900224	*
2" BSP	50	8	F	Z900232	*

Enchufes de bola 700 bar acoplamiento en presión

Quick coupling ball type 700 bar connection u/pressure

Coupleurs rapides à bille 700 bar connexion sous pression

Innesti rapido a sfera 700 bar, connessione in pressione

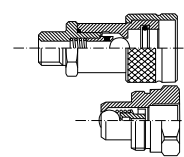

THREAD ROSCA	ISO SIZE TAMAÑO ISO	BG SIZE TAMAÑO BG	C. E.	Part nº Referencia	€
3/8" NPT	10	2	M	Z711106	86,99
3/8" NPT	10	2	F	Z711206	118,90

Válvula plana autoroscante acoplamiento en presión

Flat face screw couplings, connection u/pressure

Coupleurs face plane à visser, connexion sous pression

Vite valvola piana, connessione in pressione

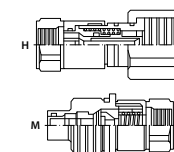

THREAD ROSCA	ISO SIZE TAMAÑO ISO	BG SIZE TAMAÑO BG	C. E.	Part nº Referencia	€
3/8" BSP	M30x2	10	2	M Z905106	234,92
1/2" BSP	M36x2	12.5	3	M Z905108	289,22
3/4" BSP	M36x2	16	4A	M Z905112	287,00
1" BSP	M43x3	19	4	M Z905116	426,62
1"1/4 BSP	M48x3	25	5	M Z905120	653,78
1"1/2 BSP	M80x4	40	7	M Z905124	*
3/8" BSP	M30X2	10	2	F Z905206	199,46
1/2" BSP	M36X2	12.5	3	F Z905208	283,68
3/4" BSP	M36X2	16	4A	F Z905212	261,51
1" BSP	M43X3	19	4	F Z905216	387,84
1"1/4 BSP	M48X3	25	5	F Z905220	559,59
1"1/2 BSP	M80X4	40	7	F Z905224	*

Crimping fittings for hoses

Pipe fittings

Pipe fittings II

Adaptors

Welding fittings

Industrial fittings

Accessories

Control components

Flow measuring

Tr/Mc LOK

Enchufes rápidos AISI 316 TrΔle

Quick couplings AISI 316 TrΔle

Coupleurs rapides AISI 316 TrΔle

Innesti rapidi AISI 316 TrΔle

Enchufes ISO A TrΔle

Quick couplings ISO A TrΔle

Coupleurs ISO A TrΔle

Innesti rapidi ISO A TrΔle

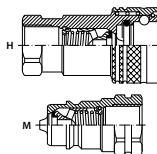

THREAD ROSCA	ISO SIZE TAMAÑO ISO	BG SIZE TAMAÑO BG	C. E.	Part nº Referencia	€
1/4" BSP	6.3	1	M	ZB820104	16,26
3/8" BSP	10	2	M	ZB820106	24,94
1/2" BSP	12.5	3	M	ZB820108	42,01
3/4" BSP	20	4	M	ZB820112	76,36
1" BSP	25	5	M	ZB820116	106,07
1/4" BSP	6.3	1	F	ZB820204	39,51
3/8" BSP	10	2	F	ZB820206	59,70
1/2" BSP	12.5	3	F	ZB820208	99,77
3/4" BSP	20	4	F	ZB820212	178,74
1" BSP	25	5	F	ZB820216	249,38

Enchufes ISO B TrΔle

Quick couplings ISO B TrΔle

Coupleurs ISO B TrΔle

Innesti rapidi ISO B TrΔle

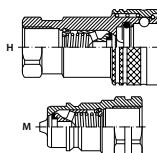

THREAD ROSCA	ISO SIZE TAMAÑO ISO	BG SIZE TAMAÑO BG	C. E.	Part nº Referencia	€
1/4" BSP	6.3	1	M	ZB800104	15,19
3/8" BSP	10	2	M	ZB800106	24,05
1/2" BSP	12.5	3	M	ZB800108	40,50
3/4" BSP	20	4	M	ZB800112	73,67
1" BSP	25	5	M	ZB800116	102,27
1/4" BSP	6.3	1	F	ZB800204	36,81
3/8" BSP	10	2	F	ZB800206	57,57
1/2" BSP	12.5	3	F	ZB800208	96,20
3/4" BSP	20	4	F	ZB800212	172,39
1" BSP	25	5	F	ZB800216	240,49

Enchufes Paso Total TrΔle

Quick couplings free flow TrΔle ISOB

Coupleurs passage total TrΔle ISOB

Innesti a passaggio libero TrΔle ISOB

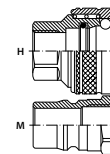

THREAD ROSCA	ISO SIZE TAMAÑO ISO	BG SIZE TAMAÑO BG	C. E.	Part nº Referencia	€
1/4" BSP	6.3	1	M	ZB830104	24,60
3/8" BSP	10	2	M	ZB830106	28,19
1/2" BSP	12.5	3	M	ZB830108	35,21
3/4" BSP	20	4	M	ZB830112	54,84
1" BSP	25	5	M	ZB830116	97,38
1/4" BSP	6.3	1	F	ZB830204	67,09
3/8" BSP	10	2	F	ZB830206	79,28
1/2" BSP	12.5	3	F	ZB830208	94,53
3/4" BSP	20	4	F	ZB830212	125,92
1" BSP	25	5	F	ZB830216	279,31

Enchufes ISO A NPT TrΔle

Quick couplings ISO A NPT TrΔle

Coupleurs ISO A NPT TrΔle

Innesti rapidi ISO A NPT TrΔle

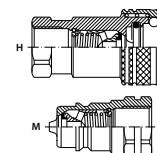

THREAD ROSCA	ISO SIZE TAMAÑO ISO	BG SIZE TAMAÑO BG	C. E.	Part nº Referencia	€
1/4" NPT	6.3	1	M	ZB801104	16,00
3/8" NPT	10	2	M	ZB801106	25,41
1/2" NPT	12.5	3	M	ZB801108	42,80
3/4" NPT	20	4	M	ZB801112	77,80
1" NPT	25	5	M	ZB801116	108,07
1/4" NPT	6.3	1	F	ZB801204	38,87
3/8" NPT	10	2	F	ZB801206	60,82
1/2" NPT	12.5	3	F	ZB801208	101,66
3/4" NPT	20	4	F	ZB801212	182,12
1" NPT	25	5	F	ZB801216	254,09

Llaves de paso AISI 316

Ball valves AISI 316

Robinets AISI 316

Rubinetti AISI 316

Crimping fittings for hoses

Pipe fittings

Pipe fittings II

Adaptors

Welding fittings

Industrial fittings

Accessories

Control components

Flow measuring

Tri/Le LOK

Llave 2 vías rosca hembra BSP

2 Way ball-valves BSP female ISO 228

Robinet haute pression 2 voies boisseau sphérique femelle BSP

Rubinetto a sfera femmina - femmina BSP

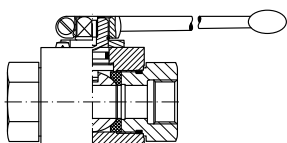

DN	THREAD ROSCA	Part nº Referencia	€
4	1/8" BSP	MKH G 1/8	217,71
6	1/4" BSP	MKH G 1/4	144,56
10	3/8" BSP	MKH G 3/8	180,96
13	1/2" BSP	MKH G 1/2	186,28
16	5/8" BSP	MKH G 5/8	438,94
20	3/4" BSP	MKH G 3/4	445,20
25	1" BSP	MKH G 1	491,72
25	1" 1/4 BSP	MKH G 1 1/4 DN25	619,95
25	1" 1/2 BSP	MKH G 1 1/2 DN25	704,05

Llave 2 vías tubo rígido serie ligera

2 Way ball-valves: tube connection serie L DIN 2353

Robinet haute pression 2 voies boisseau sphérique pour tube rigide série légère

Rubinetto a sfera maschio DIN 2353 - L -

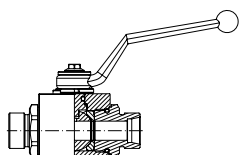

DN	PIPE TUBO	THREAD ROSCA	Part nº Referencia	€
4	6 L	M12X1,5	MKH 6 L	289,46
6	8 L	M14X1,5	MKH 8 L	255,81
8	10 L	M16X1,5	MKH 10 L	255,81
10	12 L	M18X1,5	MKH 12 L	234,98
13	15 L	M22X1,5	MKH 15 L	274,01
16	18 L	M26X1,5	MKH 18 L	325,40
20	22 L	M30X2	MKH 22 L	477,27
25	28 L	M36X2	MKH 28 L	607,96
25/32	35 L	M45X2	MKH 35 L	637,69
25/40	42 L	M52X2	MKH 42 L	856,69

Llave 2 vías tubo rígido serie pesada

2 Way ball-valves: tube connection serie S DIN 2353

Robinet haute pression 2 voies boisseau sphérique pour tube rigide série lourde

Rubinetto a sfera maschio DIN 2353 - S -

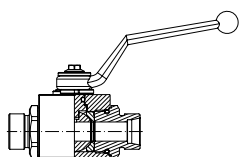

DN	PIPE TUBO	THREAD ROSCA	Part nº Referencia	€
4	8 S	M16X1,5	MKH 8 S	255,81
6	10 S	M18X1,5	MKH 10 S	266,99
8	12 S	M20X1,5	MKH 12 S	225,03
10	14 S	M22X1,5	MKH 14 S	295,90
13	16 S	M24X1,5	MKH 16 S	242,00
13	20 S	M30X2	MKH 20 S DN13	354,60
16	20 S	M30X2	MKH 20 S	410,55
20	25 S	M36X2	MKH 25 S	444,14
25	30 S	M42X2	MKH 30 S	512,21
25/32	38 S	M52X2	MKH 38 S	583,96

Llave 2 vías rosca hembra BSP paso total

Ball-valves BSP female

Robinet haute pression 2 voies boisseau sphérique femelle

Rubinetto a sfera femmina - femmina BSP

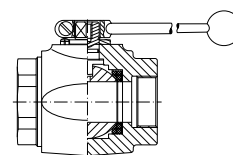

DN	THREAD ROSCA	Part nº Referencia	€
32	1" 1/4 BSP	MKH G 1 1/4 DN32	1.056,55
40	1" 1/2 BSP	MKH G 1 1/2 DN40	1.416,65
50	2" BSP	MKH G 2 DN50	1.858,45

Llave 2 vías tubo rígido L paso total

Ball-valves: tube connection serie L DIN 2353 full bore

Robinet haute pression 2 voies boisseau sphérique Métrique série légère passage total

Rubinetto a sfera maschio DIN 2353 - L -

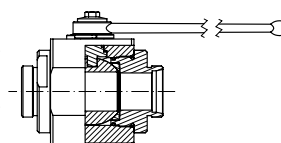

DN	PIPE TUBO	THREAD ROSCA	Part nº Referencia	€
35	35 L	M45X2	MKH 35 L DN35	1.224,98
42	42 L	M52X2	MKH 42 L DN42	1.406,11

Llave 2 vías tubo rígido S paso total

Ball-valves: tube connection serie S DIN 2353 full bore

Robinet haute pression 2 voies boisseau sphérique Métrique série légère passage total

Rubinetto a sfera maschio DIN 2353 - S -

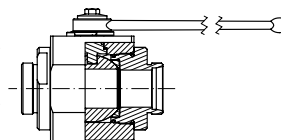

DN	PIPE TUBO	THREAD ROSCA	Part nº Referencia	€
32	38 S	M52x2	MKH 38 S DN32	1.193,80

Llave 3 vías hembra - hembra - hembra BSP paso en L

3 Way ball-valve female BSP L flow

Robinet haute pression 3 voies boisseau sphérique femelle BSP passage en L

Rubinetto a sfera 3 vie femmina BSP passaggio in L

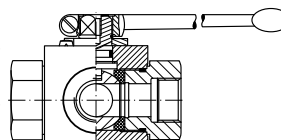

DN	THREAD ROSCA	Part nº Referencia	€
4	1/8" BSP	MK3A-G 1/8	471,53
6	1/4" BSP	MK3A-G 1/4	371,16
10	3/8" BSP	MK3A-G 3/8	522,74
13	1/2" BSP	MK3A-G 1/2	457,43
20	3/4" BSP	MK3A-G 3/4	932,12
25	1" BSP	MK3A-G 1	1.309,37
25	1" 1/4 BSP	MK3A-G 1 1/4	1.362,92
25	1" 1/2 BSP	MK3A-G 1 1/2	1.455,57

Ball valves

Llaves de paso
Kugelhähne
Robinets

■ **Handles for ball-valves 1**
Manetas
Handhebel für Kugelhähne
Leviers pour robinets

■ **Handles for ball-valves 2**
Manetas
Handhebel für Kugelhähne
Leviers pour robinets

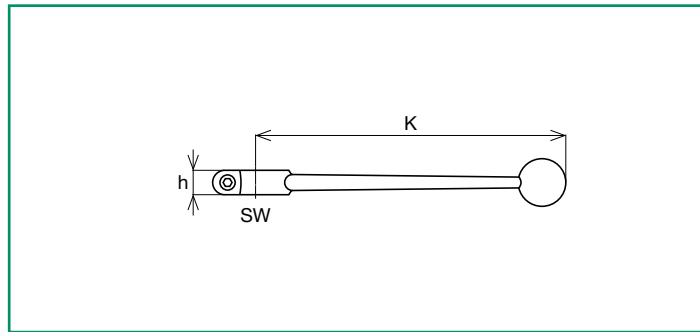
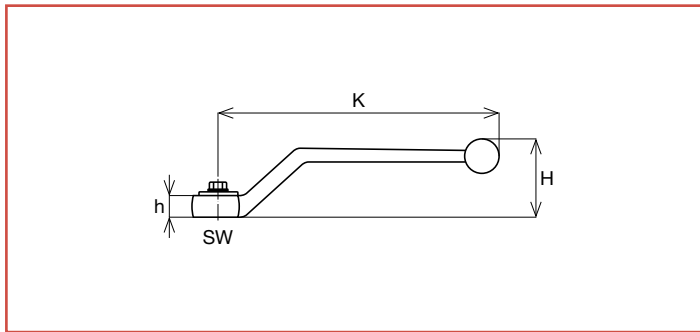

	SW	Zinc Zinc Zink Zinc			Aluminum Aluminio Aluminium Aluminium			INOX/SS316L			Steel Acero Stahl Acciaio					
Serie BSP 1/8 - 1/4 - 3/8 - 1/2 - 5/8	9	A60013155330* (1)			AR603722*			Z60013155330 *			C600063*					
Serie DIN 6 - 8 - 10 - 12 - 14 - 15 - 16		H	J	K	H	J	K	H	J	K	H	J	K			
		45	8.7	155	-	10	155	45	8.7	155	47	9	155			
Serie BSP 3/8	12	A60013155331* (1)			L501741* (1)			Z60013155331*			C708618*					
Serie DIN 18					H	J	K							H	J	K
		55	12	160												
Serie BSP 3/4 - 1 - 1 1/4	14	A60013155331* (1)			LR606745 *			Z60013155331*			C708618*					
Serie DIN 22 - 25 - 28 - 30 - 35 - 38		H	J	K	H	J	K	H	J	K	H	J	K			
		-	13	200	-	12	200	-	13	200	64	12	171			
Serie BSP 1 1/4 - 1 1/2 - 2	17	A60013155332* (1)			LR801799* (1)			Z60013155332*			C708618*					
Serie DIN 3 3-5 - 38 - 42					H	J	K	H	J	K				H	J	K
					-	16	320	-	15	90						

■ **Handles for ball-valves are supplied with zinc or aluminum**
Las llaves se suministran con maneta de zinc o aluminio
Die Schlüssel werden mit Zink- oder Aluminiumgriff geliefert
Maniglia sono fornite con manico in zinco o alluminio

(1) **Handles are supplied for ball-valves** / *Maneta sumistrada junto a la llave* / *Griff mit dem Schlüssel geliefert* / *Maniglia sono fornite con manico*

Llaves de paso AISI 316 TrΔle

Ball valves AISI 316 TrΔle
Robinetts AISI 316 TrΔle
Rubinetti AISI 316 TrΔle

Crimping fittings for hoses

Pipe fittings

Pipe fittings II

Adaptors

Welding fittings

Industrial fittings

Accessories

Control components

Flow measuring

TrΔle LOK

Llave 2 vías rosca hembra BSP TrΔle

2 ways ball valve female BSP TrΔle

Robinet haute pression 2 voies boisseau sphérique femelle BSP TrΔle

Rubinetto a sfera femmina BSP TrΔle



DN	THREAD ROSCA	Part nº Referencia	€
4	1/8" BSP	ZGB2V 1/8	65,84
6	1/4" BSP	ZGB2V 1/4	110,31
10	3/8" BSP	ZGB2V 3/8	134,58
13	1/2" BSP	ZGB2V 1/2	149,40
20	3/4" BSP	ZGB2V 3/4	228,65
25	1" BSP	ZGB2V 1	316,34

Llave 2 vías tubo rígido serie ligera TrΔle

2 ways ball valve: tube connector light serie TrΔle

Robinet haute pression 2 voies boisseau sphérique sortie pour tube rigide Série légère TrΔle

Rubinetto a sfera DIN 2353 - L TrΔle



DN	PIPE TUBO	THREAD ROSCA	Part nº Referencia	€
6	8 L	M14X1,5	ZGB2V 8 L	119,07
8	10 L	M16X1,5	ZGB2V 10 L	132,77
10	12 L	M18X1,5	ZGB2V 12 L	137,18
13	15 L	M22X1,5	ZGB2V 15 L	160,67
16	18 L	M26X1,5	ZGB2V 18 L	160,67
20	22 L	M30X2	ZGB2V 22 L	293,21
25	28 L	M36X2	ZGB2V 28 L	315,54

Manetas para llaves de paso

Handles for ball-valves

Leviers pour robinets

Manopole per rubinetti a sfera

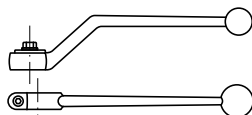

SIZE TAMAÑO	Part nº Referencia	€
HEX9	Z60013155330	21,07
HEX14	Z60013155331	35,35
HEX17	Z60013155332	241,94

Ver tabla de dimensiones en pág 218 / See dimension table in page 218 / Voir table de dimensions à la page 218 / Vedere tabella di dimensioni a pagina 218

Llave 2 vías rosca hembra NPT TrΔle

2 ways ball valve female NPT TrΔle

Robinet haute pression 2 voies boisseau sphérique femelle NPT TrΔle

Rubinetto a sfera femmina NPT TrΔle



DN	THREAD ROSCA	Part nº Referencia	€
6	1/4" NPT	ZGB2V 1/4 NPT	110,31
10	3/8" NPT	ZGB2V 3/8 NPT	134,58
12	1/2" NPT	ZGB2V 1/2 NPT	149,40
19	3/4" NPT	ZGB2V 3/4 NPT	228,65

Llave 2 vías tubo rígido serie pesada TrΔle

2 ways ball valve: tube connector heavy serie TrΔle

Robinet haute pression 2 voies boisseau sphérique sortie pour tube rigide Série lourde TrΔle

Rubinetto a sfera DIN 2353 - S TrΔle



DN	PIPE TUBO	THREAD ROSCA	Part nº Referencia	€
4	8 S	M16X1,5	ZGB2V 8 S	118,60
6	10 S	M18X1,5	ZGB2V 10 S	118,60
8	12 S	M20X1,5	ZGB2V 12 S	132,77
10	14 S	M22X1,5	ZGB2V 14 S	137,47
13	16 S	M24X1,5	ZGB2V 16 S	160,67
16	20 S	M30X2	ZGB2V 20 S	168,47
20	25 S	M36X2	ZGB2V 25 S	293,21

Racores giratorios AISI 316 TrΔle

Quick couplings, ball valves and swivel fittings AISI 316 TrΔle
Coupleurs rapides, robinets et raccords tournants AISI 316 TrΔle
Innesti rapidi, rubinetti e giunti girevole AISI 316 TrΔle

Racores giratorios rectos TrΔle

Straight swivel fittings TrΔle

Raccord tournant droit TrΔle

Giunti girevoli diritti TrΔle

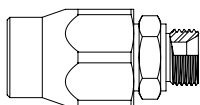

THREAD ROSCA	Part nº Referencia	€
1/4" BSP	Z GGL 1/4	196,86
3/8" BSP	Z GGL 3/8	225,93
1/2" BSP	Z GGL 1/2	253,47
3/4" BSP	Z GGL 3/4	323,85
1" BSP	Z GGL 1	433,50
1" 1/4 BSP	Z GGL 1 1/4	605,37
1" 1/2 BSP	Z GGL 1 1/2	912,90
2" BSP	Z GGL 2	1.224,00

Racores giratorios 90° TrΔle

Elbow 90° swivel female TrΔle

Raccord tournant coude 90° TrΔle

Giunti girevoli 90° TrΔle

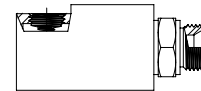

THREAD ROSCA	Part nº Referencia	€
1/4" BSP	Z GG90 1/4	246,33
3/8" BSP	Z GG90 3/8	298,86
1/2" BSP	Z GG90 1/2	366,18
3/4" BSP	Z GG90 3/4	448,80
1" BSP	Z GG90 1	604,35
1" 1/4 BSP	Z GG90 1 1/4	942,48
1" 1/2 BSP	Z GG90 1 1/2	1.303,56
2" BSP	Z GG90 2	1.871,70

RACORES GIRATORIOS | STRAIGHT SWIVEL FITTINGS

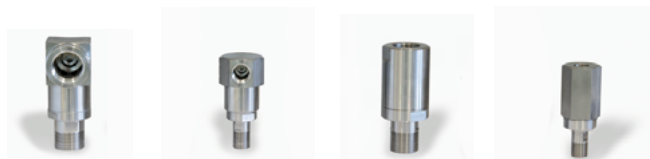

Racores giratorios para compensar la rotación y torsión de la manguera y prevenir sus posibles daños.

Straight swivel fittings can compensate the hose rotation and torsion to prevent possible damage.

Ver ficha técnica | Check technical sheet



Elementos de control

Control components

Éléments de contrôle

Elementi di controllo

Componentes hidráulicos AISI 316

Hydraulic Components AISI 316

Composants Hydrauliques AISI 316

Componenti Idraulici AISI 316

225

8

Componentes hidráulicos AISI 316

Hydraulic Components AISI 316
Composants Hydrauliques AISI 316
Componenti Idraulici AISI 316

- Reguladores caudal / Flow control valves / Régulateurs de débit / Regolatori di flusso

| 225



ZFT2251B



ZFT2253U



ZFT22512B



ZFT22572B



ZFT22575U

- Anti-retornos / Check-valves / Clapet antiretour / Valvole di ritegno

| 226

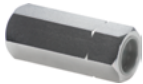

Z FPR

- Anti-retornos TrΔle / Check-valves TrΔle / Clapet antiretour TrΔle / Valvole di ritegno TrΔle

| 226



ZVT0

Componentes hidráulicos AISI 316

Hydraulic Components AISI 316
Composants Hydrauliques AISI 316
Componenti Idraulici AISI 316

Regulador caudal forjado bidireccional 350 Bar

Forged bidirectional flow control valve 350 Bar

Régulateur débit bidirectionnel forgé 350 Bar

Valvola di regolazione bidirezionale battuto 350 Bar



THREAD ROSCA	MAX. FLOW (l/min) CAUDAL MÁX.	FILTRATION DEGREE GRADO DE FILTRACIÓN	Part nº Referencia	€
1/4" BSP M17x1	12	25µ	ZFT2251B04	158,33
3/8" BSP M20x1	30	25µ	ZFT2251B06	195,49
1/2" BSP M25x1,5	45	25µ	ZFT2251B08	305,11
3/4" BSP M30x1,5	85	25µ	ZFT2251B12	411,03

Regulador caudal forjado unidireccional 350 Bar

Forged unidirectional flow control valve 350 Bar

Régulateur débit unidirectionnel forgé 350 Bar

Valvola di regolazione unidirezionale battuto



THREAD ROSCA	MAX. FLOW (l/min) CAUDAL MÁX.	FILTRATION DEGREE GRADO DE FILTRACIÓN	Part nº Referencia	€
1/4" BSP M17x1	12	25µ	ZFT2253U04	189,93
3/8" BSP M20x1	30	25µ	ZFT2253U06	231,26
1/2" BSP M25x1,5	45	25µ	ZFT2253U08	328,98
3/4" BSP M30x1,5	85	25µ	ZFT2253U12	441,79

Regulador caudal forjado bidireccional macho/hembra 350 Bar

Forged unidirectional flow control valve male/female 350 Bar

Régulateur débit bidirectionnel forgé mâle/femelle 350 Bar

Valvola di regolazione unidirezionale battuto maschio/femmina 350 Bar



THREAD ROSCA	MAX. FLOW (l/min) CAUDAL MÁX.	FILTRATION DEGREE GRADO DE FILTRACIÓN	Part nº Referencia	€
1/8" BSP M15x1	10	25µ	ZFT22512B02	184,39
1/4" BSP M17x1	13	25µ	ZFT22512B04	171,54
3/8" BSP M20x1	30	25µ	ZFT22512B06	211,81
1/2" BSP M25x1,5	60	25µ	ZFT22512B08	313,96
3/4" BSP M30x1,5	80	25µ	ZFT22512B12	422,96

Regulador caudal bidireccional 400 Bar

Bidirectional flow control valve 400 Bar

Régulateur débit bidirectionnel 400 Bar

Valvola di regolazione bidirezionale 400 Bar



THREAD ROSCA	MAX. FLOW (l/min) CAUDAL MÁX.	FILTRATION DEGREE GRADO DE FILTRACIÓN	Part nº Referencia	€
1/4" BSP M20x1	13	25µ	ZFT22572B04	232,74
3/8" BSP M25x1,5	38	25µ	ZFT22572B06	303,62
1/2" BSP M30x1,5	50	25µ	ZFT22572B08	442,86
3/4" BSP M40x1,5	80	25µ	ZFT22572B12	685,55
1" BSP M50x1,5	190	25µ	ZFT22572B16	1.379,79
1"1/4" BSP M50x1,5	195	25µ	ZFT22572B20	1.507,76
1"1/2" BSP M55x2	200	25µ	ZFT22572B24	2.384,37
2" BSP M65x2	200	25µ	ZFT22572B32	3.111,96

Regulador caudal unidireccional 400 Bar

Unidirectional flow control valve 400 Bar

Régulateur débit unidirectionnel 400 Bar

Valvola di regolazione unidirezionale 400 Bar



THREAD ROSCA	MAX. FLOW (l/min) CAUDAL MÁX.	FILTRATION DEGREE GRADO DE FILTRACIÓN	Part nº Referencia	€
1/8" BSP M17x1	6	25µ	ZFT22575U02	408,35
1/4" BSP M20x1	14	25µ	ZFT22575U04	343,42
3/8" BSP M25x1,5	20	25µ	ZFT22575U06	430,19
1/2" BSP M30x1,5	45	25µ	ZFT22575U08	581,99
3/4" BSP M40x1,5	80	25µ	ZFT22575U12	901,87
1" BSP M50x1,5	180	25µ	ZFT22575U16	1.551,57
1"1/4" BSP M50x1,5	200	25µ	ZFT22575U20	1.700,61
1"1/2" BSP M55x2	200	25µ	ZFT22575U24	3.061,12
2" BSP M65x2	200	25µ	ZFT22575U32	4.038,47

Componentes hidráulicos AISI 316

Hydraulic Components AISI 316
Composants Hydrauliques AISI 316
Componenti Idraulici AISI 316

Anti-retorno en línea BSP

Check-valve line mounting BSP

Clapet antiretour simple en ligne BSP

Valvole di ritegno in linea BSP

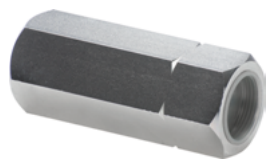

THREAD ROSCA	SETTING (bar) TARAJE (bar)	Part n° Referencia	€
1/4" BSP	0,5	Z FPR 1/4	54,83
1/4" BSP	2,5	Z FPR 1/4-2.5	99,45
1/4" BSP	5	Z FPR 1/4-5	99,45
1/4" BSP	10	Z FPR 1/4-10	99,45
3/8" BSP	0,5	Z FPR 3/8	62,99
3/8" BSP	2,5	Z FPR 3/8-2.5	107,10
3/8" BSP	5	Z FPR 3/8-5	107,10
3/8" BSP	10	Z FPR 3/8-10	137,70
1/2" BSP	0,5	Z FPR 1/2	71,50
1/2" BSP	2,5	Z FPR 1/2-2.5	127,50
1/2" BSP	5	Z FPR 1/2-5	127,50
1/2" BSP	10	Z FPR 1/2-10	127,50
3/4" BSP	0,5	Z FPR 3/4	125,41
1" BSP	0,5	Z FPR 1	193,49
1" 1/4 BSP	0,5	Z FPR 1 1/4	343,03
1" 1/2 BSP	0,5	Z FPR 1 1/2	414,27

Para otras presiones de tarado estandard, consultar. / For other standard spring pressures, consult us. / Pour d'autres pressions ressort standard, consultez-nous. / Per altre pressioni di taratura standard, consultare.

Antiretorno en línea BSP TrΔle

Check-valve line mounting BSP TrΔle

Clapet antiretour simple en ligne BSP TrΔle

Valvole di ritegno in linea BSP TrΔle



THREAD ROSCA	SETTING (bar) TARAJE (bar)	Part n° Referencia	€
1/4" BSP	0.5	ZVT001004	26,64
3/8" BSP	0.5	ZVT001006	33,11
1/2" BSP	0.5	ZVT001008	42,43
3/4" BSP	0.5	ZVT001012	64,53

Para otras presiones de tarado estandard, consultar. / For other standard spring pressures, consult us. / Pour d'autres pressions ressort standard, consultez-nous. / Per altre pressioni di taratura standard, consultare.

Metrología

Flow measuring

Test du circuit hydraulique

Test per circuiti idraulici

Racores de control

Test couplings

Prises de pression

Prese di pressione

233

Conexiones Micro-hose

Micro-hose fittings

Embouts Capillaire

Raccordi Micro-tubo

234

Instrumentos de medición

Pressure gauges AISI 316 with glycerin

Manomètre AISI 316 avec glycérine

Manometri AISI 316 a bagno di glicerina

235

9

Racores de control

Test couplings
Prises de pression
Prese di pressione

■ Racores de Control / Checking fittings / Prises de pression / Prese di pressione

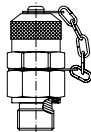

ZMPR...C/J



ZMPRTL M

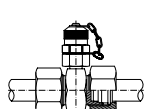

ZMPRDL/S

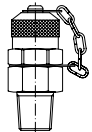

ZMPR...NPT

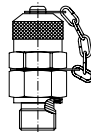

ZMPR M...C/J

Conexiones Micro-hose

Micro-hose fittings
Embouts Capillaire
Raccordi Micro-tubo

■ Conexiones Micro-hose / Micro-hose fittings / Embouts Capillaire / Raccordi Micro-tubo

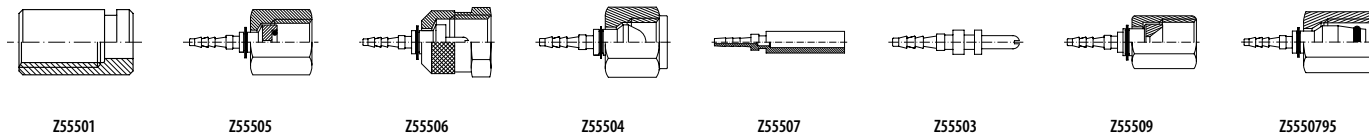

Crimping fittings for hoses

Pipe fittings

Pipe fittings II

Adaptors

Welding fittings

Industrial fittings

Accessories

Control components

Flow measuring

Tr/Me LOK

Instrumentos de medición

Pressure gauges AISI 316 with glycerin

Manomètre AISI 316 avec glycérine

Manometri AISI 316 a bagno di glicerina

- Manómetros inox glicerina DN 63 / Pressure gauge DN 63 with glycerin / Manomètre avec glycérine DN 63 / Manometro DN 63 a bagno di glicerina | 235



ZMF163..V



ZMF163..DB

- Manómetros inox glicerina DN 100 / Pressure gauge DN 100 with glycerin / Manomètre avec glycérine DN 100 / Manometro DN 100 a bagno di glicerina | 235



ZMF1100..V



ZMF1100..DB

- Protectores manómetros / Valves for manometers / Valves pour manomètres / Esclusori per manometro | 236



Z FPE



Z FPEA



ZFT2299

Racores de control

Test couplings
Prises de pression
Prese di pressione

Racores de control BSP con Junta y capuchón metálico

Check couplings with captive seal and metallic cap

Prises de pression avec joint plat et capouchon métallique

Mini-prese di controllo BSP con guarnizione y tappo metallico

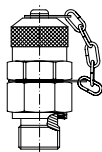

THREAD ROSCA	Part nº Referencia	€
1/8" BSP	Z MPR 1/8 G	46,66
1/4" BSP	Z MPR 1/4 G	46,84
3/8" BSP	Z MPR 3/8 G	59,95
1/2" BSP	Z MPR 1/2 G	61,49

Racores de control TLM con capuchón metálico

TLM Check couplings with metallic cap

Prises de pression TLM avec capouchon métallique

Mini-prese di controllo TLM con tappo metallico

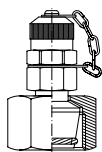

PIPE TUBO	SERIE	THREAD ROSCA	Part nº Referencia	€
6	L	M12x1.5	Z MPR TLM 6L	94,33
8	L	M14x1.5	Z MPR TLM 8L	96,78
10	L	M16x1.5	Z MPR TLM 10L	102,90
12	L	M18x1.5	Z MPR TLM 12L	98,00
15	L	M22x1.5	Z MPR TLM 15L	98,63
6	S	M14x1.5	Z MPR TLM 6S	95,55
8	S	M16x1.5	Z MPR TLM 8S	96,78
10	S	M18x1.5	Z MPR TLM 10S	105,35
12	S	M20x1.5	Z MPR TLM 12S	104,13

Racor de control intermedio para tubo metálico

Halfway check fitting for metal tube

Raccord intermédiaire pour tube métallique

Mini presa di controllo Intermedia per tubo metallico

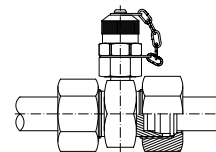

PIPE TUBO	SERIE	Part nº Referencia	€
6	L	Z MPR DL 6	102,90
8	L	Z MPR DL 8	107,80
10	L	Z MPR DL 10	116,38
12	L	Z MPR DL 12	105,35
15	L	Z MPR DL 15	115,15
18	L	Z MPR DL 18	132,30
22	L	Z MPR DL 22	149,45
28	L	Z MPR DL 28	226,63
35	L	Z MPR DL 35	238,88
42	L	Z MPR DL 42	218,05
6	S	Z MPR DS 6	102,90
8	S	Z MPR DS 8	112,70
10	S	Z MPR DS 10	120,05
12	S	Z MPR DS 12	111,48
14	S	Z MPR DS 14	129,85
16	S	Z MPR DS 16	120,05
20	S	Z MPR DS 20	153,13
25	S	Z MPR DS 25	189,88
30	S	Z MPR DS 30	230,30
38	S	Z MPR DS 38	230,30

Racores de control NPT con capuchón metálico

NPT Check couplings with metallic cap

Prises de pression NPT avec capouchon métallique

Mini-prese di controllo NPT con tappo metallico

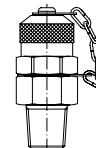

THREAD ROSCA	Part nº Referencia	€
1/8" NPT	Z MPR 1/8 NPT	59,95
1/4" NPT	Z MPR 1/4 NPT	59,95
3/8" NPT	Z MPR 3/8 NPT	59,95

Racores de control Métrico con Junta y capuchón metálico

Metric Check couplings with captive seal and metallic cap

Prises de pression métrique avec joint plat et capouchon métallique

Mini-prese di controllo Metrica con guarnizione y tappo metallico

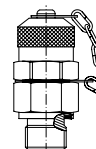

THREAD ROSCA	Part nº Referencia	€
M10X1.5	Z MPR M 10X1.5	58,34
M12X1.5	Z MPR M 12X1.5	58,34
M14X1.5	Z MPR M 14X1.5	56,79
M16X1.5	Z MPR M 16X1.5	56,79

Conexiones Micro-hose

Micro-hose fittings
Embouts Capillaire
Raccordi Micro-tubo

Casquillos AISI-303

Ferrules AISI-303

Jupes AISI-303

Boccole AISI-303

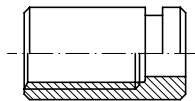

DN	Part nº Referencia	€
2	Z555010100	2,66

Hembra asiento plano con junta manómetro

Swivel female flat seat with o'ring for manometer
Micro-hose

Embout femelle tournante fond plat avec o'ring
pour manomètre Minimes

Femmina sede piana con o'ring per manometro

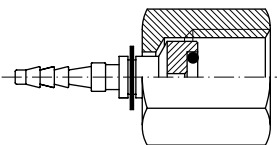

DN	THREAD ROSCA	Part nº Referencia	€
2	1/4" BSP	Z555050404	16,11
2	1/2" BSP	Z555050808	27,28

Hembra giratoria de control

Check Metric swivel female Micro-hose

Embout femelle tournante de control Métrique
Minimes

Presca di pressione femmina

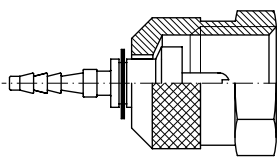

DN	THREAD ROSCA	Part nº Referencia	€
2	M16X2	Z555069523	17,17

Hembra giratoria BSP 60°

Straight swivel female BSP 60° cone micro-hose

Embout femelle tournante gaz cyl BSP 60°
Minimes

Femmina girevole BSP

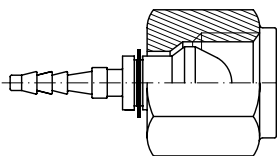

DN	THREAD ROSCA	Part nº Referencia	€
2	1/8" BSP	Z555040202	30,20
2	1/4" BSP	Z555040404	16,47
2	1/2" BSP	Z555040606	26,67

Espiga lisa Métrica

Metric standpipe Micro-hose

Embout lisse Métrique Minimes

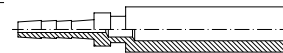

Estremità tubolare Metrica

DN	PIPE TUBO	Part nº Referencia	€
2	6	Z555070600	7,73
2	8	Z555070800	10,76

Macho de control

Straight Micro-hose check male

Embout mâle manomètre

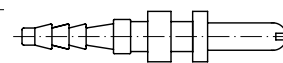

Presca di pressione maschio

DN	Part nº Referencia	€
2	Z555030325	9,18

Hembra giratoria recta JIC 37°

Straight swivel female JIC 37° Micro-hose

Embout femelle tournante JIC 37° Minimes

Femmina diritta JIC 37°

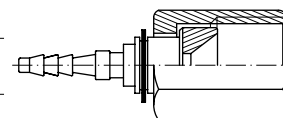

DN	THREAD ROSCA	Part nº Referencia	€
2	7/16" 20h UNF	Z555090700	14,42

Hembra giratoria Métrica con Junta

Check 24°Metric swivel female with o'ring

Embout femelle tournante de control Métrique
24° avec o'ring

Presca di pressione femmina metrica 24° con
o'ring

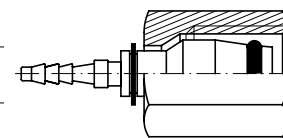

DN	PIPE TUBO	THREAD ROSCA	Part nº Referencia	€
2	6L	M12X1,5	Z555079510	11,65
2	6S	M14X1,5	Z555079511	24,75
2	8L	M14X1,5	Z555079512	26,27
2	8S	M16X1,5	Z555079523	27,60
2	10L	M16X1,5	Z555079525	30,20

Instrumentos de medición

Pressure gauges AISI 316 with glycerin

Manomètre AISI 316 avec glycérine

Manometri AISI 316 a bagno di glicerina

Manómetros DN 63 salida vertical

Pressure gauge DN 63 vertical connection

Manomètre DN 63 sortie verticale

Manometro DN 63 radiale



THREAD ROSCA	SCALE (bar) ESCALA (bar)	Part n° Referencia	€
1/4" BSP	0-2.5	ZMFI6304002.5V	*
1/4" BSP	0-4	ZMFI6304004V	*
1/4" BSP	0-6	ZMFI6304006V	29,02
1/4" BSP	0-10	ZMFI6304010V	29,02
1/4" BSP	0-16	ZMFI6304016V	29,02
1/4" BSP	0-25	ZMFI6304025V	29,02
1/4" BSP	0-40	ZMFI6304040V	29,02
1/4" BSP	0-60	ZMFI6304060V	29,02
1/4" BSP	0-100	ZMFI6304100V	29,02
1/4" BSP	0-160	ZMFI6304160V	29,02
1/4" BSP	0-250	ZMFI6304250V	29,02
1/4" BSP	0-400	ZMFI6304400V	29,02
1/4" BSP	0-600	ZMFI6304600V	29,02

Manómetros DN 63 dorsal

Pressure gauge DN 63 rear connection

Manomètre DN 63 sortie arrière

Manometro DN 63 assiale flangiato



THREAD ROSCA	SCALE (bar) ESCALA (bar)	Part n° Referencia	€
1/4" BSP	0-10	ZMFI6304010DB	32,24
1/4" BSP	0-16	ZMFI6304016DB	32,24
1/4" BSP	0-25	ZMFI6304025DB	32,24
1/4" BSP	0-60	ZMFI6304060DB	32,24
1/4" BSP	0-160	ZMFI6304160DB	32,24
1/4" BSP	0-250	ZMFI6304250DB	32,24
1/4" BSP	0-400	ZMFI6304400DB	32,24

Manómetros DN 100 salida vertical

Pressure gauge DN 100 vertical connection

Manomètre DN 100 sortie verticale

Manometro DN 100 radiale



THREAD ROSCA	SCALE (bar) ESCALA (bar)	Part n° Referencia	€
1/2" BSP	0-6	ZMFI10008006V	*
1/2" BSP	0-10	ZMFI10008010V	49,33
1/2" BSP	0-16	ZMFI10008016V	49,33
1/2" BSP	0-25	ZMFI10008025V	49,33
1/2" BSP	0-40	ZMFI10008040V	*
1/2" BSP	0-60	ZMFI10008060V	49,33
1/2" BSP	0-100	ZMFI10008100V	49,33
1/2" BSP	0-160	ZMFI10008160V	49,33
1/2" BSP	0-250	ZMFI10008250V	49,33
1/2" BSP	0-400	ZMFI10008400V	49,33
1/2" BSP	0-600	ZMFI10008600V	49,33

Manómetros DN 100 dorsal

Pressure gauge DN 100 rear connection

Manomètre DN 100 sortie arrière

Manometro DN 100 assiale flangiato



THREAD ROSCA	SCALE (bar) ESCALA (bar)	Part n° Referencia	€
1/2" BSP	0-1	ZMFI10008001DB	53,12
1/2" BSP	0-4	ZMFI10008004DB	53,12
1/2" BSP	0-6	ZMFI10008006DB	53,12
1/2" BSP	0-10	ZMFI10008010DB	53,12
1/2" BSP	0-16	ZMFI10008016DB	53,12
1/2" BSP	0-25	ZMFI10008025DB	53,12
1/2" BSP	0-40	ZMFI10008040DB	53,12
1/2" BSP	0-60	ZMFI10008060DB	53,12
1/2" BSP	0-100	ZMFI10008100DB	53,12
1/2" BSP	0-160	ZMFI10008160DB	53,12
1/2" BSP	0-250	ZMFI10008250DB	53,12
1/2" BSP	0-400	ZMFI10008400DB	*

Instrumentos de medición

Pressure gauges AISI 316 with glycerin
 Manomètre AISI 316 avec glycérine
 Manometri AISI 316 a bagno di glicerina

Protector manómetro recto

Pressure gauge protector (line mounting)

Isolateur de manomètre droit (en ligne)

Esclusore per manometro diritto



THREAD ROSCA		Part n° Referencia	€
1/4" BSP	1/4" BSPT	Z FPE 1G 1/4	161,15

Protector manómetro 90°

90° pressure gauge protector (line mounting)

Isolateur de manomètre coudé a 90° (en ligne)

Esclusore per manometro a 90°



THREAD ROSCA		Part n° Referencia	€
1/4" BSP	1/4" BSPT	Z FPEA 1G 1/4	161,15

Adaptador para manómetro en línea TL-MF

Pressure gauge adaptor (in line) SF-FM

Adapteur pour manomètre (en ligne) TL-MF

Esclusore per manometro M-F



THREAD ROSCA	Part n° Referencia	€
1/4"	ZFT229904	58,80
1/2"	ZFT229908	75,58

TrΔle LOK

TrΔle LOK

TrΔle LOK

TrΔle LOK

Racor Doble Anillo TrΔle LOK

Twin Ferrule Fittings TrΔle LOK

Raccords double bague TrΔle LOK

Raccordi per doppio anello TrΔle LOK

243

10

Racor Doble Anillo TrΔle LOK

Twin Ferrule Fittings TrΔle LOK

Raccords double bague TrΔle LOK

Raccordi per doppio anello TrΔle LOK

- Tuercas y anillos / Nuts and rings / Écrous et bagues / Dadi e anelli | 243

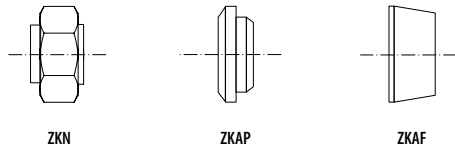

- Uniones tubo-tubo / Straight couplings / Raccords union double / Raccordi intermedi | 244

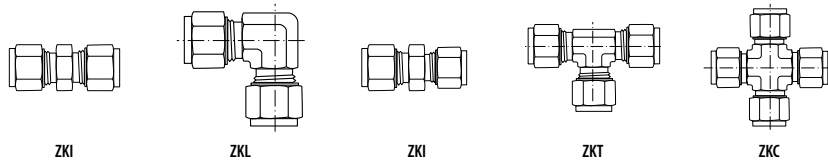

- Uniones rectas tubo-rosca macho / Straight male stud couplings / Raccords union simple mâle / Raccordi di estremità diritti | 245

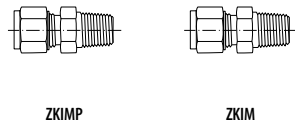

- Codos tubo-rosca / Male stud elbows / Raccords coude mâle gaz / Raccordi di estremità a 90° | 246

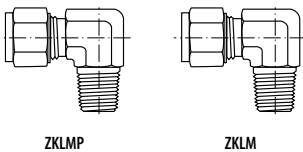

- TES rosca central / Male stud branch / Raccords Té mâle central / Raccordi di estremità a T | 246

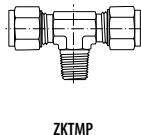

- TES rosca lateral / Male stud barrel / Raccords Té mâle latéral / Raccordi di estremità a L | 247

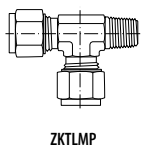

- Pasatabiques / Bulkhead / Raccords passe cloison / Raccordi di attraversamento | 247

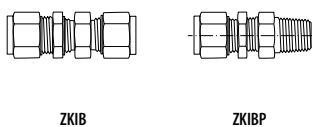

- Racor recto hembra / Straight female coupling / Raccords droits femelle / Raccordi diritti con estremità femmina | 248

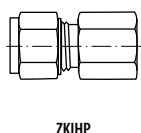

Racor Doble Anillo TrΔle LOK

Twin Ferrule Fittings TrΔle LOK

Raccords double bague TrΔle LOK

Raccordi per doppio anello TrΔle LOK

- Tapones /Plugs / Raccords bouchon métrique / Tappi

| 249

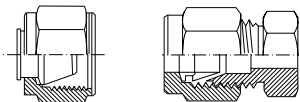

ZKOH

ZKOM

- Conectores para tubo / Pipe connector / Connecteur de tuyau / Connettore per tubi

| 249

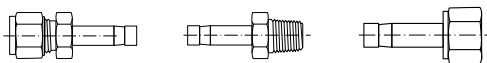

ZKIA

ZKIAMP

ZKIAHP

TRALE® LOK SERIES

INFORMACIÓN DE CODIFICACIÓN / CODIFICATION INFORMATION

1 EJEMPLO- EXAMPLE

ZKTK02

ZK: DICSА TRALE® LOK SERIES

T: FIGURA (RACOR EN TE)/
FIGURE (TE UNION)

02: Ø Tubo (02 = 1/8")
Ø Tube (02 = 1/8")

2 EJEMPLO- EXAMPLE

ZKIMP0202

ZK: DICSА TRALE® LOK SERIES

IM: RACOR RECTO ROSCA TUBO/
STRAIGHT MALE STUD

P02: MACHO 1/8" NPT
MALE 1/8" NPT

02: Ø Tubo (02 = 1/8")
Ø Tube (02 = 1/8")

REF / CODE	DESCRIPCIÓN / DESCRIPTION
ZKN	Tuercas / Nuts
ZKAP	Anillo trasero / Back Ferrule
ZKAF	Anillo frontal / Front Ferrule
ZKI	Unión recta / Straight Union
ZKL	Unión en codo / Elbow Union
ZKT	Unión en T / Tee Union
ZKC	Unión en cruz / Cross Union
ZKIM	Unión recta tubo-rosca / Straight male stud
ZKLMP	Codo tubo - rosca / Male stud elbow
ZKTMP	T tubo - rosca / Male stud T
ZKTLM	L tubo - rosca / Male stud L
ZKIB	Pasatabiques recto / Straight bulkhead
ZKIBP	Pasatabiques tubo-rosca / Male stud bulkhead
ZKIHP	Unión tubo-rosca hembra / Straight female stud
ZKOH	Tapón hembra / Cap
ZKOM	Tapón macho / Plug
ZKIA	Reductor tubo / Pipe Reducer
ZKIAH	Adap. hembra / Female adapter
ZKIMP	Adap macho / Male adapter

DESIGNACIÓN DE TUBO EXTERIOR/ TUBE O.D. DESIGNATOR

TUBO EN PULGADAS / FRACTIONAL TUBE								TUBO MÉTRICO / METRIC TUBE											
1/8"	1/4"	5/16"	3/8"	1/2"	5/8"	3/4"	1"	6	8	10	12	14	15	16	18	20	22	25	
02	04	05	06	08	10	12	16	06M	08M	10M	12M	14M	15M	16M	18M	20M	22M	25M	



Racor Doble Anillo TrΔle LOK

Twin Ferrule Fittings TrΔle LOK

Raccords double bague TrΔle LOK

Raccordi per doppio anello TrΔle LOK

Tuercas para doble anillo

Nut for twin-ferrule

Écrou double bagues

Dado per doppia ghiera

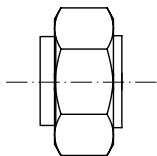

PIPE TUBO	Part n° Referencia	€
1/8"	ZKN02	4,45
1/4"	ZKN04	4,68
5/16"	ZKN05	*
3/8"	ZKN06	5,55
1/2"	ZKN08	7,33
5/8"	ZKN10	*
3/4"	ZKN12	*
1"	ZKN16	*
6	ZKN06M	4,68
8	ZKN08M	5,13
10	ZKN10M	5,87
12	ZKN12M	7,24
14	ZKN14M	*
15	ZKN15M	*
16	ZKN16M	*
18	ZKN18M	*
20	ZKN20M	*
22	ZKN22M	*
25	ZKN25M	*

Anillo frontal

Front Ferrule

Virole avant

Ghiera frontale

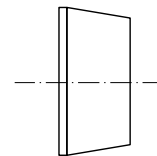

PIPE TUBO	Part n° Referencia	€
1/8"	ZKAF02	1,70
1/4"	ZKAF04	1,70
5/16"	ZKAF05	*
3/8"	ZKAF06	1,79
1/2"	ZKAF08	2,89
5/8"	ZKAF10	*
3/4"	ZKAF12	*
1"	ZKAF16	*
6	ZKAF06M	1,70
8	ZKAF08M	1,79
10	ZKAF10M	1,88
12	ZKAF12M	2,84
14	ZKAF14M	*
15	ZKAF15M	*
16	ZKAF16M	*
18	ZKAF18M	*
20	ZKAF20M	*
22	ZKAF22M	*
25	ZKAF25M	*

Anillo posterior

Back Ferrule

Virole arrière

Indietro ghiera

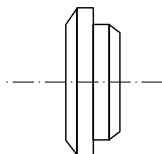

PIPE TUBO	Part n° Referencia	€
1/8"	ZKAP02	1,83
1/4"	ZKAP04	1,93
5/16"	ZKAP05	*
3/8"	ZKAP06	2,25
1/2"	ZKAP08	3,62
5/8"	ZKAP10	*
3/4"	ZKAP12	*
1"	ZKAP16	*
6	ZKAP06M	1,93
8	ZKAP08M	2,11
10	ZKAP10M	2,29
12	ZKAP12M	3,53
14	ZKAP14M	*
15	ZKAP15M	*
16	ZKAP16M	*
18	ZKAP18M	*
20	ZKAP20M	*
22	ZKAP22M	*
25	ZKAP25M	*

Racor Doble Anillo TrΔle LOK

Twin Ferrule Fittings TrΔle LOK

Raccords double bague TrΔle LOK

Raccordi per doppio anello TrΔle LOK

Racor unión recta tubo - tubo

Straight coupling

Raccord union double

Raccordo intermedio diritto

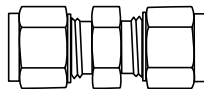

PIPE TUBO	Part nº Referencia	€
1/8"	ZKI02	20,76
1/4"	ZKI04	21,50
5/16"	ZKI05	*
3/8"	ZKI06	24,43
1/2"	ZKI08	34,33
5/8"	ZKI10	*
3/4"	ZKI12	*
1"	ZKI16	*
6	ZKI06M	21,63
8	ZKI08M	23,24
10	ZKI10M	25,80
12	ZKI12M	34,10
14	ZKI14M	*
15	ZKI15M	*
16	ZKI16M	*
18	ZKI18M	*
20	ZKI20M	*
22	ZKI22M	*
25	ZKI25M	*

Racor unión en codo tubo - tubo

Equal elbow coupling

Raccord coude égal

Raccordo intermedio a 90°

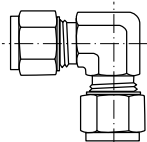

PIPE TUBO	Part nº Referencia	€
1/8"	ZKL02	25,44
1/4"	ZKL04	25,99
5/16"	ZKL05	*
3/8"	ZKL06	30,25
1/2"	ZKL08	40,33
5/8"	ZKL10	*
3/4"	ZKL12	*
1"	ZKL16	*
6	ZKL06M	25,94
8	ZKL08M	29,01
10	ZKL10M	32,59
12	ZKL12M	39,88
14	ZKL14M	*
15	ZKL15M	*
16	ZKL16M	*
18	ZKL18M	*
20	ZKL20M	*
22	ZKL22M	*
25	ZKL25M	*

Racor unión recta en reducción tubo - tubo

Straight reducing coupling

Raccord union double en réduction

Raccordo di riduzione

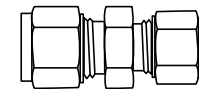

PIPE TUBO		Part nº Referencia	€
1/4"	1/8"	ZKI0402	*
3/8"	1/4"	ZKI0604	*
1/2"	3/8"	ZKI0806	*
3/4"	1/2"	ZKI1208	*
1"	3/4"	ZKI1612	*
8	6	ZKI08M06M	*
10	8	ZKI10M08M	*
12	10	ZKI12M10M	*
16	12	ZKI16M12M	*
18	12	ZKI18M12M	*
25	20	ZKI25M20M	*

Racor unión en T tubo - tubo

Equal Tee

Raccord Té égal

Raccordo intermedio a T

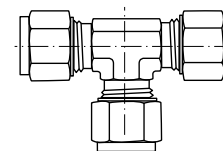

PIPE TUBO	Part nº Referencia	€
1/8"	ZKT02	36,44
1/4"	ZKT04	37,26
5/16"	ZKT05	*
3/8"	ZKT06	43,91
1/2"	ZKT08	57,75
5/8"	ZKT10	*
3/4"	ZKT12	*
1"	ZKT16	*
6	ZKT06M	37,22
8	ZKT08M	42,63
10	ZKT10M	44,55
12	ZKT12M	57,11
14	ZKT14M	*
15	ZKT15M	*
16	ZKT16M	*
18	ZKT18M	*
20	ZKT20M	*
22	ZKT22M	*
25	ZKT25M	*

Racor unión en cruz tubo - tubo

Equal cross

Raccord croix égale

Raccordo intermedio a croce

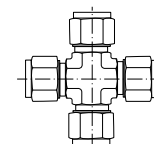

PIPE TUBO	Part nº Referencia	€
1/8"	ZKC02	*
1/4"	ZKC04	*
5/16"	ZKC05	*
3/8"	ZKC06	*
1/2"	ZKC08	*
6	ZKC06M	*
8	ZKC08M	*
10	ZKC10M	*
12	ZKC12M	*

Racor Doble Anillo TrΔle LOK

Twin Ferrule Fittings TrΔle LOK

Raccords double bague TrΔle LOK

Raccordi per doppio anello TrΔle LOK

Racor recto rosca cónica NPT

Straight male stud coupling NPT

Raccord union simple mâle NPT

Raccordo di estremità diritto NPT

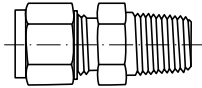

PIPE TUBO	THREAD ROSCA	Part nº Referencia	€
1/8"	1/8"	ZKIMP0202	12,28
1/8"	1/4"	ZKIMP0204	12,70
1/8"	3/8"	ZKIMP0206	13,66
1/8"	1/2"	ZKIMP0208	16,50
1/4"	1/8"	ZKIMP0402	12,56
1/4"	1/4"	ZKIMP0404	13,02
1/4"	3/8"	ZKIMP0406	13,93
1/4"	1/2"	ZKIMP0408	16,78
3/8"	1/8"	ZKIMP0602	14,35
3/8"	1/4"	ZKIMP0604	14,62
3/8"	3/8"	ZKIMP0606	15,03
3/8"	1/2"	ZKIMP0608	17,37
1/2"	1/8"	ZKIMP0802	21,27
1/2"	1/4"	ZKIMP0804	21,27
1/2"	3/8"	ZKIMP0806	21,27
1/2"	1/2"	ZKIMP0808	22,37
6	1/8"	ZKIMP06M02	12,79
6	1/4"	ZKIMP06M04	12,97
6	3/8"	ZKIMP06M06	14,03
6	1/2"	ZKIMP06M08	16,64
8	1/8"	ZKIMP08M02	13,66
8	1/4"	ZKIMP08M04	13,89
8	3/8"	ZKIMP08M06	14,67
8	1/2"	ZKIMP08M08	17,97
10	1/8"	ZKIMP10M02	16,04
10	1/4"	ZKIMP10M04	16,36
10	3/8"	ZKIMP10M06	16,36
10	1/2"	ZKIMP10M08	18,79
12	1/4"	ZKIMP12M04	21,31
12	3/8"	ZKIMP12M06	21,31
12	1/2"	ZKIMP12M08	21,86

Racor recto rosca cónica BSPT

Straight male stud coupling BSPT

Raccord union simple mâle conique

Raccordo di estremità diritto BSP conico

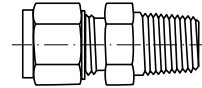

PIPE TUBO	THREAD ROSCA	Part nº Referencia	€
1/4"	1/4"	ZKIM0404	*
3/8"	1/4"	ZKIM0604	*
3/8"	3/8"	ZKIM0606	*
1/2"	1/4"	ZKIM0804	*
1/2"	3/8"	ZKIM0806	*
1/2"	1/2"	ZKIM0808	*
6	1/4"	ZKIM06M04	*
6	3/8"	ZKIM06M06	*
6	1/2"	ZKIM06M08	*
8	3/8"	ZKIM08M06	*
8	1/2"	ZKIM08M08	*
10	3/8"	ZKIM10M06	*
10	1/2"	ZKIM10M08	*
12	1/2"	ZKIM12M08	*

Crimping fittings for hoses

Pipe fittings

Pipe fittings II

Adaptors

Welding fittings

Industrial fittings

Accessories

Control components

Flow measuring

TrΔle LOK

Racor Doble Anillo Tralle LOK

Twin Ferrule Fittings Tralle LOK

Raccords double bague Tralle LOK

Raccordi per doppio anello Tralle LOK

Racor en codo rosca cónica NPT

Male stud elbow NPT

Raccord union coude mâle NPT

Raccordo di estremità a 90° NPT

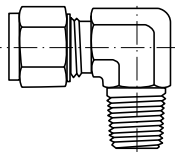

PIPE TUBO	THREAD ROSCA	Part n° Referencia	€
1/8"	1/8"	ZKLMP0202	18,52
1/8"	1/4"	ZKLMP0204	18,93
1/8"	3/8"	ZKLMP0206	20,90
1/4"	1/8"	ZKLMP0402	18,79
1/4"	1/4"	ZKLMP0404	19,20
1/4"	3/8"	ZKLMP0406	20,90
1/4"	1/2"	ZKLMP0408	25,99
3/8"	1/8"	ZKLMP0602	22,00
3/8"	1/4"	ZKLMP0604	22,00
3/8"	3/8"	ZKLMP0606	22,00
3/8"	1/2"	ZKLMP0608	27,59
1/2"	1/4"	ZKLMP0804	28,88
1/2"	3/8"	ZKLMP0806	28,88
1/2"	1/2"	ZKLMP0808	30,75
6	1/8"	ZKLMP06M02	18,79
6	1/4"	ZKLMP06M04	19,16
6	3/8"	ZKLMP06M06	20,90
6	1/2"	ZKLMP06M08	26,49
8	1/8"	ZKLMP08M02	20,76
8	1/4"	ZKLMP08M04	20,76
8	3/8"	ZKLMP08M06	21,18
8	1/2"	ZKLMP08M08	27,18
10	1/8"	ZKLMP10M02	23,88
10	1/4"	ZKLMP10M04	23,88
10	3/8"	ZKLMP10M06	23,88
10	1/2"	ZKLMP10M08	27,45
12	1/4"	ZKLMP12M04	28,69
12	3/8"	ZKLMP12M06	28,69
12	1/2"	ZKLMP12M08	30,53

Racor en codo rosca cónica BSPT

Male stud elbow BSPT

Raccord union coude mâle gaz conique

Raccordo di estremità a 90° BSP conico

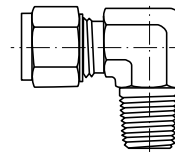

PIPE TUBO	THREAD ROSCA	Part n° Referencia	€
1/4"	1/4"	ZKLM0404	*
1/4"	3/8"	ZKLM0406	*
1/4"	1/2"	ZKLM0408	*
3/8"	3/8"	ZKLM0606	*
3/8"	3/8"	ZKLM0608	*
1/2"	1/2"	ZKLM0808	*
6	1/4"	ZKLM06M04	*
6	1/2"	ZKLM06M08	*
8	3/8"	ZKLM08M06	*
8	1/2"	ZKLM08M08	*
10	3/8"	ZKLM10M06	*
10	1/2"	ZKLM10M08	*

Racor en T rosca cónica NPT

Male stud branch TEE NPT

Raccord TÉ mâle NPT au centre

Raccordo di estremità a T NPT

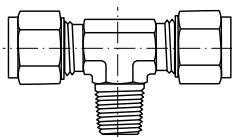

PIPE TUBO	THREAD ROSCA	Part n° Referencia	€
1/8"	1/8"	ZKTMP0202	*
1/8"	1/4"	ZKTMP0204	*
1/4"	1/8"	ZKTMP0402	*
1/4"	1/4"	ZKTMP0404	*
3/8"	1/4"	ZKTMP0604	*
3/8"	3/8"	ZKTMP0606	*
1/2"	3/8"	ZKTMP0806	*
1/2"	1/2"	ZKTMP0808	*
6	1/8"	ZKTMP06M02	*
6	1/4"	ZKTMP06M04	*
8	1/8"	ZKTMP08M02	*
8	1/4"	ZKTMP08M04	*
10	1/4"	ZKTMP10M04	*
10	3/8"	ZKTMP10M06	*
12	1/4"	ZKTMP12M04	*
12	3/8"	ZKTMP12M06	*
12	1/2"	ZKTMP12M08	*

Racor Doble Anillo TrΔle LOK

Twin Ferrule Fittings TrΔle LOK

Raccords double bague TrΔle LOK

Raccordi per doppio anello TrΔle LOK

Crimping fittings for hoses

Pipe fittings

Pipe fittings II

Adaptors

Welding fittings

Industrial fittings

Accessories

Control components

Flow measuring

TrΔle LOK

Racor en L rosca cónica NPT

Male stud barrel TEE NPT

Raccord Té mâle NPT latéral Inox

Raccordo di estremità a L NPT conico

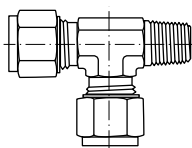

PIPE TUBO	THREAD ROSCA	Part nº Referencia	€
1/8"	1/8"	ZKTLMP0202	*
1/8"	1/4"	ZKTLMP0204	*
1/4"	1/8"	ZKTLMP0402	*
1/4"	1/4"	ZKTLMP0404	*
3/8"	1/4"	ZKTLMP0604	*
3/8"	3/8"	ZKTLMP0606	*
1/2"	3/8"	ZKTLMP0806	*
1/2"	1/2"	ZKTLMP0808	*
6	1/8"	ZKTLMP06M02	*
6	1/4"	ZKTLMP06M04	*
8	1/8"	ZKTLMP08M02	*
8	1/4"	ZKTLMP08M04	*
10	1/4"	ZKTLMP10M04	*
10	1/2"	ZKTLMP10M08	*
12	1/4"	ZKTLMP12M04	*
12	3/8"	ZKTLMP12M06	*
12	1/2"	ZKTLMP12M08	*

Racor recto pasatabique con tuercas

Straight bulkhead coupling

Raccord droit union double passe cloison avec écrou

Raccordo passaparete

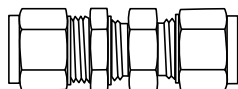

PIPE TUBO	Part nº Referencia	€
1/8"	ZKIB02	*
1/4"	ZKIB04	*
5/16"	ZKIB05	*
3/8"	ZKIB06	*
1/2"	ZKIB08	*
5/8"	ZKIB10	*
3/4"	ZKIB12	*
1"	ZKIB16	*
6	ZKIB06M	*
8	ZKIB08M	*
10	ZKIB10M	*
12	ZKIB12M	*
15	ZKIB15M	*
16	ZKIB16M	*
18	ZKIB18M	*
20	ZKIB20M	*
25	ZKIB25M	*

Racor recto - NPT pasatabique con tuercas

Straight bulkhead coupling - NPT

Raccord droit union double passe cloison avec écrou - NPT

Raccordo passaparete - NPT

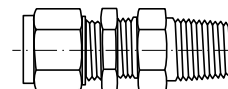

PIPE TUBO	THREAD ROSCA	Part nº Referencia	€
1/8"	1/8"	ZKIBP0202	*
1/4"	1/4"	ZKIBP0404	*
3/8"	3/8"	ZKIBP0606	*
1/2"	1/2"	ZKIBP0808	*
3/4"	3/4"	ZKIBP1212	*
1"	1"	ZKIBP1616	*
6	1/8"	ZKIBP06M02	*
8	1/4"	ZKIBP08M04	*
10	3/8"	ZKIBP10M06	*
12	1/2"	ZKIBP12M08	*

Racor Doble Anillo TrΔle LOK

Twin Ferrule Fittings TrΔle LOK

Raccords double bague TrΔle LOK

Raccordi per doppio anello TrΔle LOK

Racor recto hembra rosca NPT

Female stud coupling NPT

Raccord union simple femelle gaz

Raccordo diritto femmina NPT

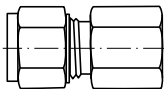

PIPE TUBO	THREAD ROSCA	Part nº Referencia	€
1/8"	1/8"	ZKIHP0202	13,70
1/8"	1/4"	ZKIHP0204	15,03
1/8"	3/8"	ZKIHP0206	16,59
1/8"	1/2"	ZKIHP0208	19,16
1/4"	1/8"	ZKIHP0402	14,48
1/4"	1/4"	ZKIHP0404	15,86
1/4"	1/4"	ZKIHP0406	16,87
1/4"	3/8"	ZKIHP0408	20,35
3/8"	1/2"	ZKIHP0602	15,86
3/8"	1/4"	ZKIHP0604	16,96
3/8"	3/8"	ZKIHP0606	18,24
3/8"	1/2"	ZKIHP0608	21,82
1/2"	1/2"	ZKIHP0802	21,18
1/2"	1/4"	ZKIHP0804	21,18
1/2"	3/8"	ZKIHP0806	21,91
1/2"	1/2"	ZKIHP0808	25,53
5/8"	1/2"	ZKIHP1008	*
3/4"	3/4"	ZKIHP1212	*
1"	1"	ZKIHP1616	*
6	1/8"	ZKIHP06M02	14,35
6	1/4"	ZKIHP06M04	15,77
6	3/8"	ZKIHP06M06	16,82
6	1/2"	ZKIHP06M08	20,81
8	1/4"	ZKIHP08M04	16,50
8	3/8"	ZKIHP08M06	17,51
8	1/2"	ZKIHP08M08	21,22
10	1/4"	ZKIHP10M04	17,33
10	3/8"	ZKIHP10M06	18,43
10	1/2"	ZKIHP10M08	22,05
12	1/4"	ZKIHP12M04	21,54
12	3/8"	ZKIHP12M06	21,54
12	1/2"	ZKIHP12M08	25,12
16	1/2"	ZKIHP16M08	*
20	3/4"	ZKIHP20M12	*
22	3/4"	ZKIHP22M12	*
25	1"	ZKIHP25M16	*

Racor Doble Anillo TrΔle LOK

Twin Ferrule Fittings TrΔle LOK

Raccords double bague TrΔle LOK

Raccordi per doppio anello TrΔle LOK

Tapón de cierre hembra UNF

UNF plug closure

Casquette de fermeture femme UNF

Tappo di chiusura femmina UNF

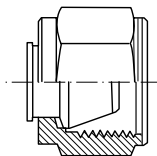

PIPE TUBO	Part nº Referencia	€
1/8"	ZKOH02	*
1/4"	ZKOH04	*
5/16"	ZKOH05	*
3/8"	ZKOH06	*
1/2"	ZKOH08	*
5/8"	ZKOH10	*
1/2"	ZKOH12	*
5/8"	ZKOH16	*
6	ZKOH06M	*
8	ZKOH08M	*
10	ZKOH10M	*
12	ZKOH12M	*
14	ZKOH14M	*
15	ZKOH15M	*
16	ZKOH16M	*
18	ZKOH18M	*
20	ZKOH20M	*
22	ZKOH22M	*
25	ZKOH25M	*

Tapón hexagonal macho UNF

UNF cap hexagon

Fiche mâle hexagonale UNF

Tappo esagonale maschio UNF

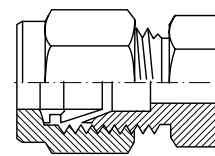

PIPE TUBO	Part nº Referencia	€
1/8"	ZKOM02	*
1/4"	ZKOM04	*
5/16"	ZKOM05	*
3/8"	ZKOM06	*
1/2"	ZKOM08	*
5/8"	ZKOM10	*
3/4"	ZKOM12	*
1"	ZKOM16	*
6	ZKOM06M	*
8	ZKOM08M	*
10	ZKOM10M	*
12	ZKOM12M	*
14	ZKOM14M	*
15	ZKOM15M	*
16	ZKOM16M	*
18	ZKOM18M	*
20	ZKOM20M	*
22	ZKOM22M	*
25	ZKOM25M	*

Racor de Reducción tubo

Tube end reducer

Réducteur de port

Riduttore di porta

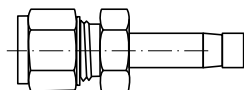

PIPE TUBO	PIPE TUBO	Part nº Referencia	€
1/4"	1/8"	ZKIA0402	*
3/8"	1/4"	ZKIA0604	*
1/2"	3/8"	ZKIA0806	*
3/4"	1/2"	ZKIA1208	*
8	6	ZKIA08M06M	*
10	8	ZKIA10M08M	*
12	10	ZKIA12M10M	*
16	12	ZKIA16M12M	*

Adaptador hembra NPT

Female NPT adaptor

Adaptateur NPT femelle

Adattatore NPT femmina

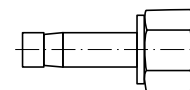

PIPE TUBO	THREAD ROSCA	Part nº Referencia	€
1/8"	1/8"	ZKIAHP0202	*
1/4"	1/4"	ZKIAHP0404	*
3/8"	3/8"	ZKIAHP0606	*
1/2"	1/2"	ZKIAHP0808	*
6	1/8"	ZKIAHP06M02	*
8	1/4"	ZKIAHP08M04	*
10	3/8"	ZKIAHP10M06	*
12	1/2"	ZKIAHP12M08	*

Adaptador macho NPT

Male NPT adaptor

Adaptateur NPT mâle

Adattatore NPT maschio

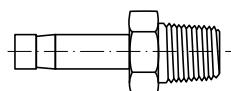

PIPE TUBO	THREAD ROSCA	Part nº Referencia	€
1/8"	1/8"	ZKIAMP0202	*
1/4"	1/4"	ZKIAMP0404	*
3/8"	3/8"	ZKIAMP0606	*
1/2"	1/2"	ZKIAMP0808	*
6	1/8"	ZKIAMP06M02	*
8	1/4"	ZKIAMP08M04	*
10	3/8"	ZKIAMP10M06	*
12	1/2"	ZKIAMP12M08	*